



3Com® Switch 4210 Family

Getting Started

Switch 4210 PWR 9-Port
Switch 4210 PWR 18-Port
Switch 4210 PWR 26-Port

Switch 4210 9-Port
Switch 4210 18-Port
Switch 4210 26-Port
Switch 4210 52-Port

3Com Corporation
350 Campus Drive
Marlborough, MA
USA 01752-3064

Copyright © 2006-2008, 3Com Corporation. All rights reserved. No part of this documentation may be reproduced in any form or by any means or used to make any derivative work (such as translation, transformation, or adaptation) without written permission from 3Com Corporation.

3Com Corporation reserves the right to revise this documentation and to make changes in content from time to time without obligation on the part of 3Com Corporation to provide notification of such revision or change.

3Com Corporation provides this documentation without warranty, term, or condition of any kind, either implied or expressed, including, but not limited to, the implied warranties, terms or conditions of merchantability, satisfactory quality, and fitness for a particular purpose. 3Com may make improvements or changes in the product(s) and/or the program(s) described in this documentation at any time.

If there is any software on removable media described in this documentation, it is furnished under a license agreement included with the product as a separate document, in the hard copy documentation, or on the removable media in a directory file named LICENSE.TXT or !LICENSE.TXT. If you are unable to locate a copy, please contact 3Com and a copy will be provided to you.

UNITED STATES GOVERNMENT LEGEND

If you are a United States government agency, then this documentation and the software described herein are provided to you subject to the following:

All technical data and computer software are commercial in nature and developed solely at private expense. Software is delivered as "Commercial Computer Software" as defined in DFARS 252.227-7014 (June 1995) or as a "commercial item" as defined in FAR 2.101(a) and as such is provided with only such rights as are provided in 3Com's standard commercial license for the Software. Technical data is provided with limited rights only as provided in DFAR 252.227-7015 (Nov 1995) or FAR 52.227-14 (June 1987), whichever is applicable. You agree not to remove or deface any portion of any legend provided on any licensed program or documentation contained in, or delivered to you in conjunction with, this User Guide.

Unless otherwise indicated, 3Com registered trademarks are registered in the United States and may or may not be registered in other countries.

3Com and the 3Com logo are registered trademarks of 3Com Corporation.

Cisco is a registered trademark of Cisco Systems, Inc.

Funk RADIUS is a registered trademark of Funk Software, Inc.

Aegis is a registered trademark of Aegis Group PLC.

Intel and Pentium are registered trademarks of Intel Corporation. Microsoft, MS-DOS, Windows, and Windows NT are registered trademarks of Microsoft Corporation. Novell and NetWare are registered trademarks of Novell, Inc. UNIX is a registered trademark in the United States and other countries, licensed exclusively through X/Open Company, Ltd.

IEEE and 802 are registered trademarks of the Institute of Electrical and Electronics Engineers, Inc.

All other company and product names may be trademarks of the respective companies with which they are associated.

ENVIRONMENTAL STATEMENT

It is the policy of 3Com Corporation to be environmentally-friendly in all operations. To uphold our policy, we are committed to:

Establishing environmental performance standards that comply with national legislation and regulations.

Conserving energy, materials and natural resources in all operations.

Reducing the waste generated by all operations. Ensuring that all waste conforms to recognized environmental standards. Maximizing the recyclable and reusable content of all products.

Ensuring that all products can be recycled, reused and disposed of safely.

Ensuring that all products are labelled according to recognized environmental standards.

Improving our environmental record on a continual basis.

End of Life Statement

3Com processes allow for the recovery, reclamation and safe disposal of all end-of-life electronic components.

Regulated Materials Statement

3Com products do not contain any hazardous or ozone-depleting material.

CONTENTS

ABOUT THIS GUIDE

Download the Latest Software and Documentation for Your 3Com Switch	5
Before You Start	5
Related Documentation	6

1 PRODUCT INTRODUCTION

Overview	7
Introduction to the Switch 4210 Family PWR Switches	8
Introduction to the Switch 4210 Family Non-PWR Models	14
Technical Specifications	19
SFP Modules Supported for the Switch 4210	21

2 INSTALLING THE SWITCH

Rack-Mounting the Switch	24
Mounting the Switch on a Desktop	27
The Power-up Sequence	27
Connecting a Redundant Power Supply	28
Connecting the Console Cable	32

3 MANAGING YOUR SWITCH

Methods of Managing a Switch	36
Setting Up Your Switch	37
Viewing Automatically Configured IP Information	40
Manually Configuring IP Information	42
Setting Up Command Line Interface Management	47
Setting Up Command Line Interface Management using SSH	48
Setting Up Web Interface Management	48
Setting Up SNMP Management	49
Default Users and Passwords	50

4 PROBLEM SOLVING

Solving Problems Indicated by LEDs	52
Solving Hardware Problems	53
Solving Communication Problems	54
Solving Fabric Formation Problems	55

A PIN-OUTS

- Null Modem Cable 57
- PC-AT Serial Cable 57
- Modem Cable 58
- Ethernet Port RJ-45 Pin Assignments 58

B OBTAINING SUPPORT FOR YOUR 3COM PRODUCTS

- Register Your Product to Gain Service Benefits 59
- Solve Problems Online 59
- Purchase Extended Warranty and Professional Services 59
- Access Software Downloads 59
- Contact Us 60

C 3COM NETWORK MANAGEMENT

- 3Com Network Supervisor 63
- 3Com Network Director 63
- 3Com Network Access Manager 64
- 3Com Enterprise Management Suite 65
- Integration Kit with HP OpenView Network Node Manager 65

D REDUNDANT POWER SUPPLY SAFETY INFORMATION

- Important Safety Information 67
- L'information de Sécurité Importante 68
- Wichtige Sicherheitsinformationen 68
- Información de Seguridad Importante 69
- Importanti Informazioni di Sicurezza 71
- Ważne informacje o zabezpieczeniach 71
- Regulatory Notices 73

ABOUT THIS GUIDE

Download the Latest Software and Documentation for Your 3Com Switch

Thank you for purchasing a 3Com Switch 4210. As part of our commitment to bringing you the most capable and dependable network equipment, 3Com offers free software maintenance updates and documentation updates on our website.

To obtain the most up-to-date operating software and user documentation for the Switch 4210, point your web browser to: www.3Com.com/4210 and select the "Support and Registration" link.

You must register your 3Com switch before receiving software upgrades. To register, point your web browser to eSupport.3Com.com.

Before You Start

The guide is intended for use by network administrators who install and set up network equipment; consequently, it assumes a basic working knowledge of LANs (Local Area Networks).

Release Notes

The **Release Notes** provide important information about the current software release, including new features, modifications, and known problems. You should read the Release Notes before installing the switch in your network.



If the information in the Release Notes differs from this guide, follow the instructions in the Release Notes.

User guides and release notes are available in Adobe Acrobat Reader Portable Document Format (PDF) on the 3Com World Wide Web site at <http://www.3com.com>

Conventions

Table 1 lists important conventions that are used throughout this guide.

Table 1 Notice Icons

Icon	Notice Type	Description
	Information note	Information that describes important features or instructions
	Caution	Information that alerts you to potential loss of data or potential damage to an application, system, or device
	Warning	Information that alerts you to potential personal injury

**Related
Documentation**

In addition to this guide, the Switch 4210 documentation set includes the following:

- *3Com Switch 4210 Family Configuration Guide*

This guide contains information on the features supported by your switch and how they can be used to optimize your network. It is supplied in PDF format on the 3Com Web site.

- *3Com Switch 4210 Family Command Reference Guide*

This guide provides detailed information about the web interface and command line interface that enable you to manage the switch. It is supplied in PDF format on the 3Com Web site.

- *Release Notes*

These notes provide information about the current software release, including new features, modifications, and known problems. The release notes are supplied in hard copy with your switch.

1

PRODUCT INTRODUCTION

Overview

The 3Com Switch 4210 Family provides high-performance, high-density, easy-to-install, NMS-manageable intelligent Ethernet switches that support wire-speed Layer 2 switching.

Three of the Switch 4210 Family models support industry standard IEEE 802.3af Power over Ethernet (PoE). Figure 1 displays these models and Table 1 provides a description of their features.

Figure 1 Power over Ethernet models



Table 1 Power over Ethernet models

Model	Power supply	Number of 10/100 Mbps ports	Number of 1000 Mbps uplink ports	Number of Console ports
Switch 4210 PWR 9-port	AC input	8	One Combo port	1
Switch 4210 PWR 18-port	AC input	16	Two Combo ports	1
Switch 4210 PWR 26-port	AC or RPS DC input	24		1 (on rear)

Three of the Switch 4210 Family models are available for simple connectivity without PoE. Figure 2 displays these models and Table 2 describes its features.

Figure 2 Non Power over Ethernet models



Table 2 Non Power over Ethernet models

Model	Power supply	Number of 10/100 Mbps ports	Number of 1000 Mbps uplink ports	Number of Console ports
Switch 4210 9-port	AC input	8	One Combo port	1
Switch 4210 18-port	AC input	16	Two Combo ports	1
Switch 4210 26-port	AC input	24	Two Combo ports	1
Switch 4210 52-port (not shown)	AC input	48	Two 10/100/100 ports Two SFP ports	1

Introduction to the Switch 4210 Family PWR Switches

Switch 4210 9-port PWR Front panel

Each Switch 4210 9-port PWR unit provides eight 10/100Base-TX autosensing Ethernet ports, one 10/100/1000Base-T Ethernet port, one 100/1000Base SFP ports, and one Console port. The SFP port and the 10/100/1000BASE-T Ethernet port form a Combo port. You can use either the SFP port or the 10/100/1000BASE-T Ethernet port at one time.

Figure 3 shows the front panel of a Switch 4210 9-port PWR.

Figure 3 Front panel of a Switch 4210 9-port PWR

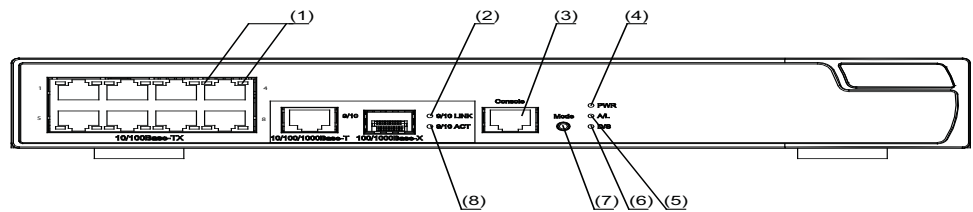

- (1) 10/100Base-TX autosensing Ethernet port status LED
- (2) Link LED for Combo port
- (3) Console port
- (4) Power LED (PWR)
- (5) A/L LED
- (6) D/S LED
- (7) Mode button
- (8) Active LED for Combo port

Rear panel

Figure 4 The Switch 4210 9-port PWR model's rear panel

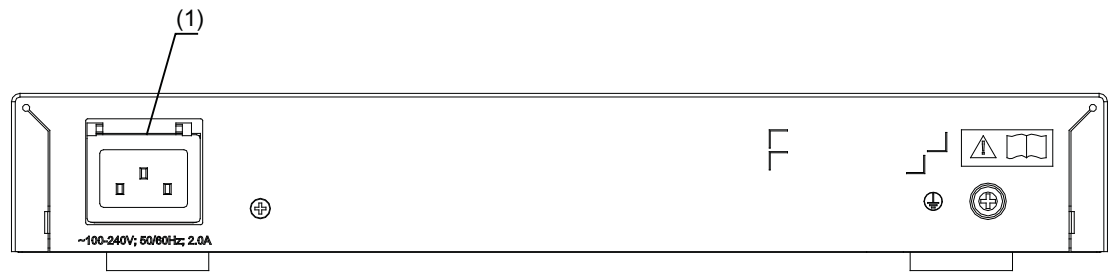

(1) AC power socket

Side panel

Each Switch 4210 9-port PWR provides a security slot through which you can lock the device together with an irremovable object to prevent theft. The security slot is located on the left side panel, as shown in Figure 7.



If the left screw hole above the security slot is used, the security slot cannot be used.

Power system

Switch 4210 PWR 9-port units are able to power attached devices using standard 802.3af Power over Ethernet. The total available power for PoE on this model is 70W, enough to power four ports at full 15.4W required of the PoE standard. Each Switch 4210 9-port PWR unit supports AC input.

- Rated Voltage Range: 100 VAC to 240 VAC, 50 Hz/60 Hz
- Input voltage range: 90 VAC to 264 VAC, 47 HZ to 63 Hz

Cooling system

The Switch 4210 9-port PWR units each run two fans for heat dissipation.

Switch 4210 PWR 18-port

Front panel

Switch 4210s 18-port PWR each provide sixteen 10/100Base-TX autosensing Ethernet ports, two 10/100/1000Base-T Ethernet ports, two 100/1000Base SFP ports, and one Console port. Each SFP port and the corresponding 10/100/1000BASE-T Ethernet port form a Combo port. For each Combo port, either the SFP port or the corresponding 10/100/1000BASE-T Ethernet port can be used at a time.

Figure 5 shows the front panel of a Switch 4210 18-port PWR.

Figure 5 Front panel of a Switch 4210 18-port PWR

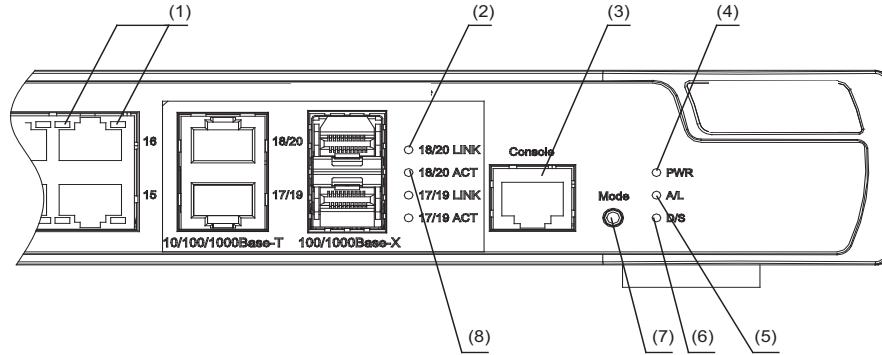

- (1) 10/100Base-TX autosensing Ethernet port status LED
- (2) Link LED for Combo port
- (3) Console port
- (4) Power LED (PWR)
- (5) A/L LED
- (6) D/S LED
- (7) Mode button
- (8) Active LED for Combo port

Rear panel

Figure 6 Rear panel of a Switch 4210 18-port PWR

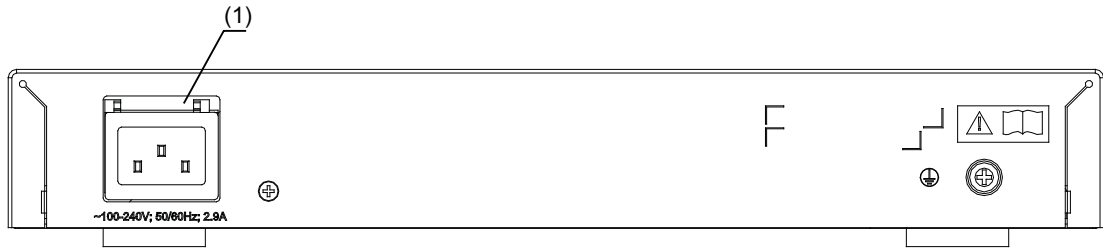

- (1) AC power socket

Side panel

Each Switch 4210 18-port PWR provides a security slot, through which you can lock the device together with an irremovable object to prevent theft. The security slot is located on the left side panel, as shown in Figure 7.

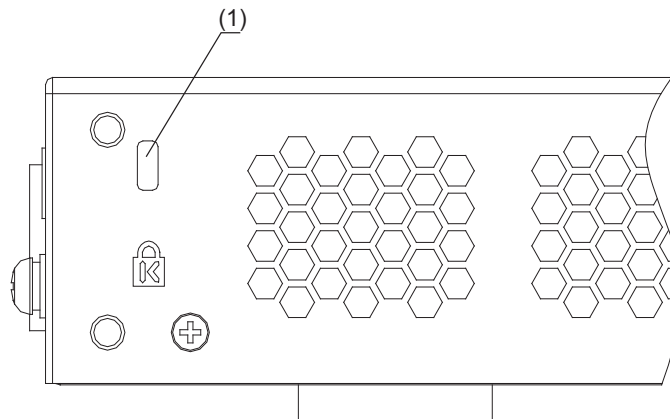
Figure 7 Security slot on left side panel of a Switch 4210 18-port PWR

(1): Security slot



If the left screw hole above the security slot is used, the security slot cannot be used.

Power system

Switch 4210 18-port PWR units support AC input.

- Rated Voltage Range: 100 VAC to 240 VAC, 50 Hz/60 Hz
- Input voltage range: 90 VAC to 264 VAC, 47 Hz to 63 Hz

Switch 4210 PWR 18-Port units are able to power attached devices using standard 802.3af Power over Ethernet. The total available power for PoE on this model is 135W; enough to power 8-Ports at full 15.4W required of the PoE standard.

Cooling system

Switch 4210s 18-port PWR each run two fans for heat dissipation.

Switch 4210 PWR 26-port

Front panel

The Switch 4210 26-port PWR model provides 24 10/100Base-TX autosensing Ethernet ports, two 10/100/1000Base-T Ethernet ports, two 100/1000Base SFP ports, and one Console port. Each SFP port and the corresponding 10/100/1000BASE-T Ethernet port form a Combo port. For each Combo port, you can use either the SFP port or the corresponding 10/100/1000BASE-T Ethernet port at one time.

Figure 8 shows the front panel of the Switch 4210 26-port PWR model.

Figure 8 The Switch 4210 26-port PWR model's front panel

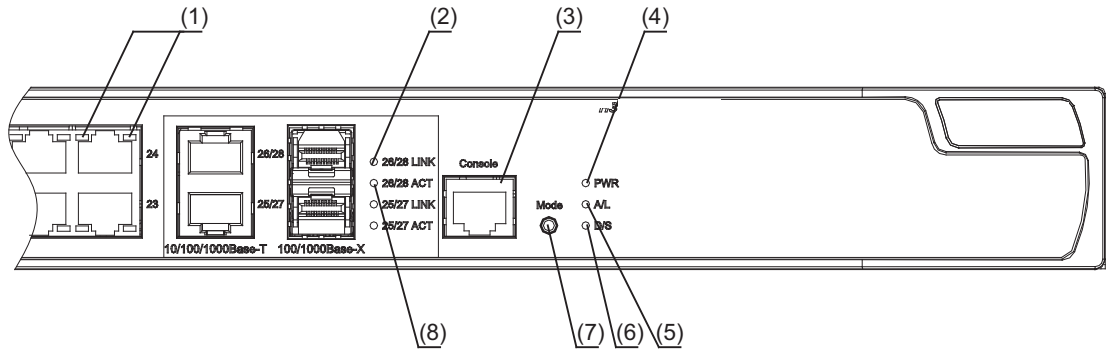

- (1) 10/100Base-TX autosensing Ethernet port status LED
- (2) Link LED for Combo port
- (3) Console port
- (4) Power LED (PWR)
- (5) A/L LED
- (6) D/S LED
- (7) Mode button
- (8) Active LED for Combo port

Rear panel

Figure 9 Rear panel of a Switch 4210 26-port PWR

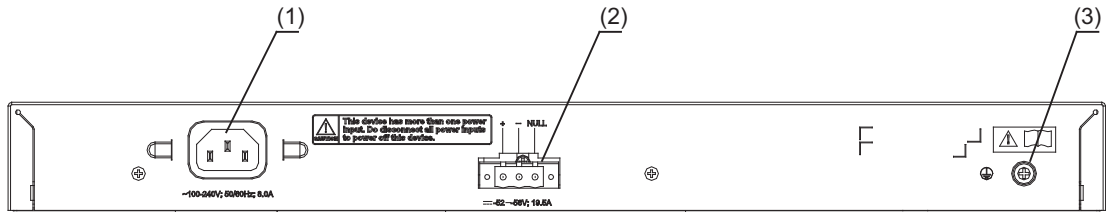

- (1) AC power socket
- (2) DC power socket
- (3) Grounding screw

Power system

Switch 4210 26-port PWR units support AC input or DC input.

- AC input
 - Rated voltage range: 100 VAC to 240 VAC, 50 Hz/60 Hz
 - Input voltage range: 90 VAC to 264 VAC, 47 Hz to 63 Hz
- DC input—Rated voltage range: -52 VDC to -56 VDC



Switch 4210 PWR 26-Port units are able to power attached devices using standard 802.3af Power over Ethernet. The total available power for PoE on this model is 370W; enough to power 24-Ports at full 15.4W required of the PoE standard.

3Com recommends a Redundant Power System (RPS) from Eaton Powerware for providing DC power to the Switch 4210 PWR 26-Port. For full details, refer to www.3com.com/rps.

Cooling system

Switch 4210 26-port PWR units each run four fans for heat dissipation.

The Switch 4210 PWR Front Panel LEDs

Power LED

Table 3 describes the power LED on the Switch 4210 PWR model.

Table 3 The power LED on the Switch 4210 PWR models

LED	Mark on the panel	Status	Description
Power LED	PWR	ON	The switch is powered on.
		OFF	The switch is powered off.

10/100BASE-TX Autosensing Ethernet Port Status LED

There are two port status LEDs on both sides (yellow LED on the left and green LED on the right) of the 10/100BASE-TX Ethernet port on the Switch 4210 PWR models. They indicate the port's active, link, duplex, and speed status.

In addition, there is an A/L LED and a D/S LED on each Switch 4210 PWR model. These two LEDs indicate the port status LEDs mode. When the A/L LED is on, the port status LEDs respectively indicate the port's active status and link status. When the D/S LED is on, the port status LEDs respectively indicate the port's duplex status and speed status. Either the A/L LED or the D/S LED is on at one time. For details, see Table 4.

Table 4 Port status LEDs on the Switch 4210 PWR models

Port status mode LED	Port status LED	Status	Description
The A/L LED is on	Yellow LED (left)	BLINKING	The port is in the active state and there is traffic on the port.
		OFF	The port is in the active state but there is no traffic on the port.
	Green LED (right)	ON	The port is connected properly.
		OFF	The port is not connected or is incorrectly connected.
The D/S LED is on	Yellow LED (left)	ON	The port operates in the full duplex mode.
		OFF	The port operates in the half duplex mode.
	Green LED (right)	ON	The port rate is 100 Mbps.
		OFF	The port rate is 10 Mbps.

You can change the mode of the port status LEDs by pressing the Mode button. After a switch is powered on, the A/L LED is on initially. If you press the Mode button, the D/S LED will be on. After that, if you press the Mode button again within 45 seconds, the A/L LED will be on again. Otherwise, the A/L LED will automatically be on 45 seconds later.

1000 Mbps Uplink Port Status LED

Table 5 describes the 1000 Mbps uplink port status LED on the Switch 4210.

Table 5 The 1000 Mbps uplink port status LED on 4210 PWR models

LED	Mark on the panel	Status	Description
1000 Mbps uplink port link LED	LINK	ON	The port is connected properly.
		OFF	The port is not connected or is incorrectly connected.

Table 5 The 1000 Mbps uplink port status LED on 4210 PWR models

LED	Mark on the panel	Status	Description
1000 Mbps uplink port active LED	ACT	BLINKING	The port is in the active state and there is traffic on the port.
		OFF	The port is in the active state but there is no traffic on the port.

Introduction to the Switch 4210 Family Non-PWR Models

This section describes each Switch 4210 Family model.

Switch 4210 9-port Front panel

The Switch 4210 9-port model provides eight 10/100Base-TX autosensing Ethernet ports, one 10/100/1000Base-T autosensing Ethernet port, one 100/1000Base-X SFP port, and one Console port. The SFP port and the 10/100/1000BASE-T autosensing Ethernet port form a Combo port. For the Combo port, either the SFP port or the 10/100/1000BASE-T Ethernet port can be used at a time.

Figure 10 shows the front panel of the Switch 4210 9-port model.

Figure 10 The Switch 4210 9-port model's front panel

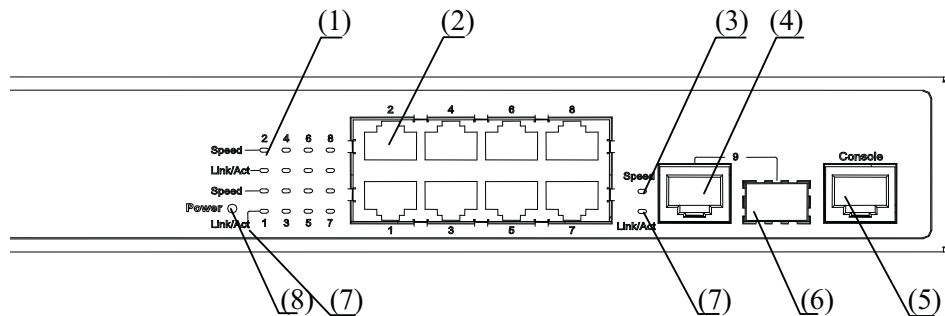

- (1) 10/100Base-TX autosensing port Speed LED (green)
- (2) 10/100Base-TX autosensing port
- (3) Combo port Speed LED (green)
- (4) 10/100/1000Base-T autosensing port
- (5) Console port
- (6) 100/1000Base-X SFP port
- (7) Link/Act LED (green)
- (8) Power LED (PWR)

Rear panel

Figure 11 The Switch 4210 9-port model's rear panel

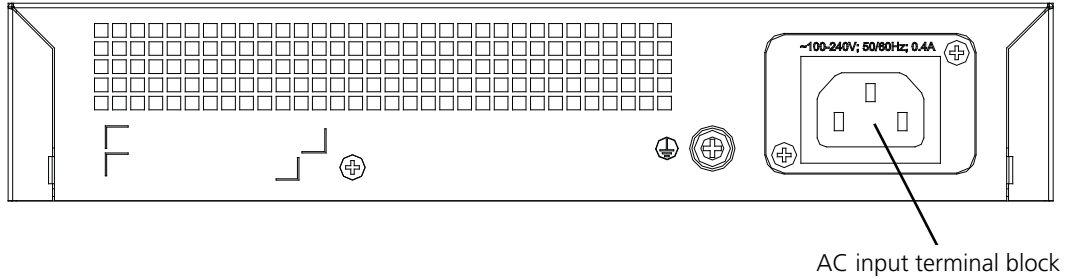

Power system

The Switch 4210 9-port model supports AC input.

- Rated Voltage Range: 100 VAC to 240 VAC, 50 Hz/60 Hz
- Input voltage range: 90 VAC to 264 VAC, 47 Hz to 63 Hz

Cooling system

The Switch 4210 cools off naturally.

Switch 4210 18-port Front panel

The Switch 4210 18-port models provide 16 10/100Base-TX autosensing Ethernet ports, two 10/100/1000Base-T autosensing Ethernet ports, two 100/1000Base-X SFP ports, and one Console port. Each SFP port and the corresponding 10/100/1000BASE-T autosensing Ethernet port form a Combo port. For each Combo port, you can use either the SFP port or the corresponding 10/100/1000BASE-T Ethernet port at one time.

Figure 12 shows the Switch 4210 18-port model's front panel.

Figure 12 The Switch 4210 18-port model's front panel

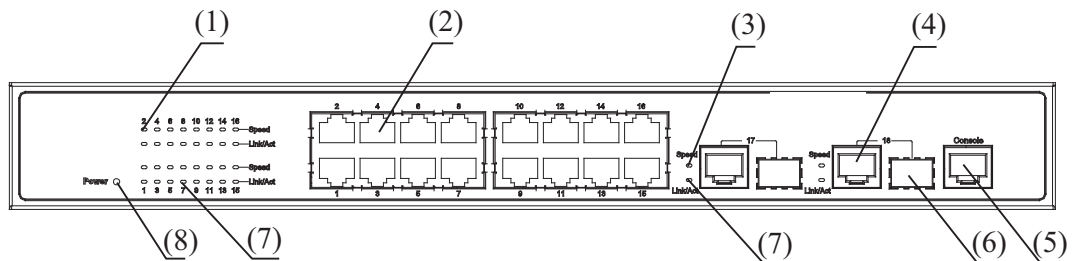

- (1) 10/100Base-TX autosensing port Speed LED (green)
- (2) 10/100Base-TX autosensing port
- (3) Combo port Speed LED (green)
- (4) 10/100/1000Base-T autosensing port
- (5) Console port
- (6) 100/1000Base-X SFP port
- (7) Link/Act LED (green)
- (8) Power LED (PWR)

Rear panel

Figure 13 The Switch 4210 18-port model's rear panel

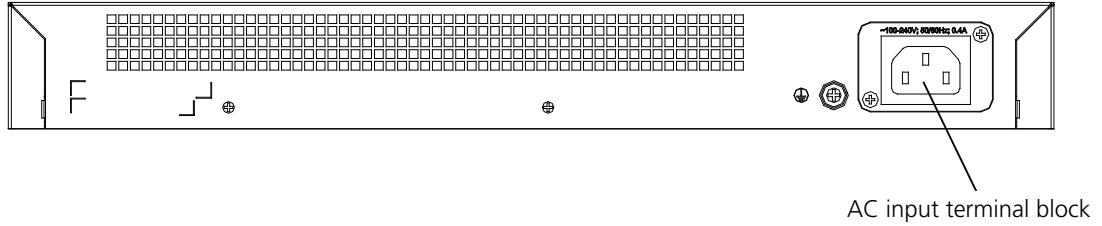

Power system

The Switch 4210 18-port model's support AC input.

- Rated Voltage Range: 100 VAC to 240 VAC, 50 Hz/60 Hz
- Input voltage range: 90 VAC to 264 VAC, 47 Hz to 63 Hz

Cooling system

3Com Switch 4210 non-PWR models cool naturally through airflow.

Switch 4210 26-port Front panel

The Switch 4210 26-port front panel provides 24 10/100Base-TX autosensing Ethernet ports, two 10/100/1000Base-T autosensing Ethernet ports, two 100/1000Base-X SFP ports, and one Console port. Each SFP port and the corresponding 10/100/1000BASE-T autosensing Ethernet port form a Combo port. For each Combo port, you can use either the SFP port or the corresponding 10/100/1000BASE-T Ethernet port at one time.

Figure 14 shows the front panel of the Switch 4210 26-port model.

Figure 14 The Switch 4210 26-port front panel

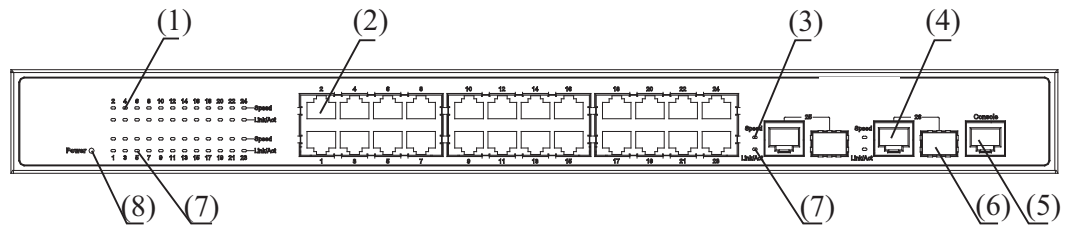

- (1) 10/100Base-TX autosensing port Speed LED (green)
- (2) 10/100Base-TX autosensing port
- (3) Combo port Speed LED (green)
- (4) 10/100/1000Base-T autosensing port
- (5) Console port
- (6) 100/1000Base-X SFP port
- (7) Link/Act LED (green)
- (8) Power LED (PWR)

Rear panel

Figure 15 The Switch 4210 26-port rear panel

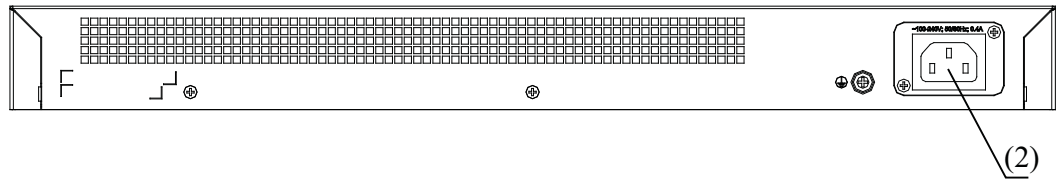

(2) AC input terminal block

Power system

The Switch 4210 26-port model supports AC input.

- Rated Voltage Range: 100 VAC to 240 VAC, 50 Hz/60 Hz
- Input voltage range: 90 VAC to 264 VAC, 47 Hz to 63 Hz

Cooling system

3Com Switch 4210 non-PWR models cool naturally through airflow.

Switch 4210 52-port Front Panel

The Switch 4210 52-port front panel provides 48 10/100Base-TX autosensing Ethernet ports, two 10/100/1000Base-T autosensing Ethernet ports, two 100/1000Base-X SFP ports (The 4 gigabit ports are all active), and one Console port. Each SFP port and the corresponding 10/100/1000BASE-T autosensing Ethernet port form a Combo port. For each Combo port, you can use either the SFP port or the corresponding 10/100/1000BASE-T Ethernet port at one time. The Switch 4210 52-port unit is displayed in Figure 16.

Figure 16 Switch 4210 52-port unit



Power system

The Switch 4210 52-port model supports AC input.

- Rated Voltage Range: 100 VAC to 240 VAC, 50 Hz/60 Hz
- Input voltage range: 90 VAC to 264 VAC, 47 Hz to 63 Hz

Cooling system

3Com Switch 4210 non-PWR models cool naturally through airflow.

Switch 4210 Family Front Panel LEDs

Power LED

Table 6 describes the power LED on the Switch 4210.

Table 6 The power LED on the Switch 4210

LED	Mark on the panel	Status	Description
Power LED	Power	ON	The switch is powered on.
		OFF	The switch is powered off.

Port LED

Table 7 describes the 10/100Base-TX autosensing port's Link/Act LED.

Table 7 The Link/Act LED on the 3Com Switch 4210

LED	Status	Description
Link/Act LED (green)	ON	The port is connected properly.
	BLINKING	The port is in the active state and there is traffic on the port.
	OFF	The port is not connected or is incorrectly connected.

Table 8 describes the Speed LED on the 10/100Base-TX port.

Table 8 The 10/100Base-TX port Speed LED on the Switch 4210

LED	Status	Description
10/100Base-TX autosensing port Speed LED (green)	ON	The port is operating at 100 Mbps.
	OFF	The port is operating at 10 Mbps.

For a description of the Link/Act LED of the Combo port, see Table 7. When the port is connected correctly, the Speed LED indicates the operating speeds of the Combo port, as shown in Table 9.

Table 9 The Combo port Speed LED on the Switch 4210

LED	Operating port	Status	Description	
Combo port Speed LED (green)	100/1000Base-X SFP port	Connected to a 1000 Mbps optical module	ON	The port is operating at 1000 Mbps.
		Connected to a 100 Mbps optical module	OFF	The port is operating at 100 Mbps.
	10/100/1000Base-T autosensing port	ON	The port is operating at 1000 Mbps.	
		OFF	The port is operating at 10/100 Mbps.	

Technical Specifications

Table 10 Technical specifications for the Switch 4210

Model	Switch 4210 52-port	Switch 4210 26-port	Switch 4210 18-port	Switch 4210 9-port
Physical dimensions (H x W x D)	43.6 x 440 x 225 mm (1.7 x 17.3 x 8.8 in.)	43.6 x 440 x 160 mm (1.7 x 17.3 x 6.3 in.)	43.6 x 360 x 160 mm (1.7 x 14.2 x 6.3 in.)	43.6 x 230 x 160 mm (1.7 x 9.1 x 6.3 in.)
Weight	12.1 lbs (5.5 Kgs)	4.7 lbs (2.14 Kgs)	3.4 lbs (1.53 kg.)	2.3 lbs (1.06 kg.)
Number of fixed ports	48 x 10/100Base-TX autosensing Ethernet port 4 x 100/1000 Mbps Combo ports	24 x 10/100Base-TX autosensing Ethernet ports 2 x 100/1000 Mbps Combo ports	16 x 10/100Base-TX autosensing Ethernet ports 2 x 100/1000 Mbps Combo ports	8 x 10/100Base-TX autosensing Ethernet ports 1 x 100/1000 Mbps Combo port
Number of management ports	1 x Console port			
Power system	AC input: <ul style="list-style-type: none"> ■ Rated voltage range: 100 VAC to 240 VAC, 50 Hz/60 Hz ■ Input voltage range: 90 VAC to 264 VAC, 47 Hz to 63 Hz 			
PoE (to power attached devices)	Not supported	Not supported	Not supported	Not supported
System power consumption (full load)	25W	14W	12W	10W
Fan	None	None	None	None
Operating temperature	0°C to 45°C (30°F to 113°F)			
Relative humidity (non-condensing)	10% to 90%			

Table 11 Technical specifications for the Switch 4210 PWR models

Model	Switch 4210 26-port PWR	Switch 4210 18-port PWR	Switch 4210 9-port PWR
Physical dimensions (H x W x D)	H 1.7 in 45 mm W 17.3 in 440 mm D 16.9 in 430 mm	H 1.7 in 45 mm W 11.8 in 300 mm D 9.2 in 233 mm	H 1.7 in 45 mm W 11.8 in 300 mm D 10.8 in 275 mm
Weight	13.4 lbs 6.09 Kgs	6.0 lbs 2.70 Kgs	4.9 lbs 2.22 Kgs
Number of fixed ports	24 x 10/100BASE-TX autosensing Ethernet ports 2 x 100/1000 Mbps Combo ports	16 x 10/100BASE-TX autosensing Ethernet ports 2 x 100/1000 Mbps Combo ports	8 x 10/100BASE-TX autosensing Ethernet ports 1 x 100/1000 Mbps Combo port
Number of management ports	1 x Console port		

Table 11 Technical specifications for the Switch 4210 PWR models

Model	Switch 4210 26-port PWR	Switch 4210 18-port PWR	Switch 4210 9-port PWR	
Power system	Switch 4210s 26-port PWR support AC input and DC input. Switch 4210 18-port PWR/Switch 4210s 9-port PWR support only AC input. AC input: <ul style="list-style-type: none"> ■ Rated voltage range: 100 VAC to 240 VAC, 50 Hz/60 Hz ■ Input voltage range: 90 VAC to 264 VAC, 47 Hz to 63 Hz DC input: <ul style="list-style-type: none"> ■ Rated voltage range: -52 VDC to -56 VDC 			
All ports serve as PoE ports	System power consumption (full load)	AC input: 25W + 370W PoE DC input: 400 W	25W + 123W PoE	20W + 62W PoE
	PoE power maximum	15.4 W × 24	15.4 W × 8	15.4 W × 4
Number of fans	4	2	2	
Operating temperature	0°C to 45°C (30°F to 113°F)			
Relative humidity (non-condensing)	10% to 90%			



The Switch 4210 26-port, 18-port, and 9-port PWR models provide an over-temperature protection mechanism. When the internal temperature exceeds 65°C (149°F), they will stop providing power from all ports. When the temperature is below 60°C (140°F), they will continue to provide power from all ports.

Related Standards

The 3Com Switch 4210 Family is designed to the following standards:

Function	8802-3, IEEE 802.3 (Ethernet), IEEE 802.3u (Fast Ethernet), IEEE 802.3ab (Gigabit Ethernet), IEEE 802.1D (Bridging)
Safety	UL 60950-1, EN 60950-1, CSA 22.2 No. 60950-1, IEC 60950-1
EMC Emissions	EN55022 Class A, CISPR 22 Class A, FCC Part 15 Subpart B Class A, ICES-003 Class A, VCCI Class A, EN61000-3-2, EN61000-3-3
EMC Immunity	EN55024

Earthing Lead

Safety Requirements	The Earthing Lead shall comply with the following safety standards: UL Subject 758, UL 1581 and CSA C22.2 No. 210 UL VW-1 and CSA FT1 Vertical Flame Test
Voltage Rating	600V
AWG	12
Insulation Thickness	0.4mm
Insulation Color	Green/Yellow

SFP Modules Supported for the Switch 4210

The Switch 4210's front panel provides one or two 1000 Mbps SFP ports in which you can plug small form-factor (SFP) modules, which are described in Table 12.

Table 12 SFP modules supported by the Switch 4210

Type	Model
100 Mbps SFP module	■ 3CSFP81
	■ 3CSFP82
1000 Mbps SFP module	■ 3CSFP91
	■ 3CSFP92
	■ 3CSFP97
100 Mbps bidirectional (BIDI) module	■ 3CSFP9-81
	■ 3CSFP9-82
1000 Mbps BIDI module	■ 3CSFP85
	■ 3CSFP86



- *The types of SFP modules may vary over time. Consult 3Com's marketing personnel or technical support personnel to obtain the latest information about SFP modules.*
- *For the SFP module specifications, refer to 3Com Transceiver Data Sheet.*

2

INSTALLING THE SWITCH

This section contains information that you need to install and set up your 3Com® switch. For information on upgrading your switch, refer to the Switch 4210 Release Notes available at www.3Com.com.



WARNING: Safety Information. Before you install or remove any components from the Switch or carry out any maintenance procedures, you must read the **3Com Switch Family Safety and Regulatory Information** document enclosed with your switch as well as Appendix D, “Redundant Power Supply Safety Information” on page 67.



AVERTISSEMENT: Consignes de securite. Avant d’installer ou d’enlever un composant du commutateur ou de réaliser une procédure de maintenance, vous devez prendre connaissance du document **3Com Switch Family Safety and Regulatory Information** accompagnant le commutateur ainsi que de l’annexe D, “Redundant Power Supply Safety Information” on page 67.



VORSICHT: Sicherheitsinformationen. Bevor Sie dem Switch Komponenten hinzufügen oder daraus entfernten oder Wartungsaufgaben durchführen, müssen Sie das dem Switch beigefügte Dokument **3Com Switch Family Safety and Regulatory Information** (Sicherheitsinformationen und Betriebsbestimmungen der 3Com Switchfamilie) sowie Anhang D, “Redundant Power Supply Safety Information” on page 67 lesen.



ADVERTENCIA: Información de seguridad. Antes de instalar o suprimir cualquier componente del conmutador o de realizar cualquier tarea de mantenimiento, debe leer el documento **3Com Switch Family Safety and Regulatory Information** adjunto con el conmutador así como el Apéndice D, “Redundant Power Supply Safety Information” on page 67.



AVVERTENZA: Informazioni di sicurezza. Prima di installare o rimuovere qualsiasi componente dallo Switch o di eseguire qualsiasi procedura di manutenzione, leggere il documento **3Com Switch Family Safety and Regulatory Information** fornito con lo switch e l'Appendice D, “Redundant Power Supply Safety Information” on page 67.



OSTRZEŻENIE: Informacje o zabezpieczeniach. Przed zainstalowaniem lub pozbyciem się jakiegokolwiek elementu z Przełącznika lub przeprowadzeniem jakichkolwiek czynności konserwacyjnych, należy obowiązkowo przeczytać **3Com Switch Family Safety and Regulatory Information** dołączone do przełącznika oraz w Załączniku D, “Redundant Power Supply Safety Information” on page 67.



CAUTION: Opening the switch or tampering with the warranty sticker can void your warranty.



ATTENTION : *le fait d'ouvrir le commutateur ou d'altérer la vignette de garantie pourrait rendre la garantie nulle.*



WARNUNG: *Öffnen des Switches oder Manipulation des Garantieraufklebers kann das Erlöschen der Garantie zur Folge haben.*



PRECAUCIÓN: *si se abre el conmutador o se manipula el adhesivo de la garantía, ésta quedará invalidada.*



ATTENZIONE: *L'apertura dello switch o la manomissione dell'adesivo di garanzia può invalidare la garanzia.*



OSTRZEŻENIE: *Otwarcie przełącznika lub naruszenie plomby gwarancyjnej może unieważnić gwarancję.*

Rack-Mounting the Switch

Switch 4210 26-Port and 52-Port models are rack-mountable in a standard 19-inch rack. Switch 4210 9- and 18-Port models are not as wide as the 19-inch model and are intended for desktop or shelf installation.

Follow the steps below to mount a 26- or 52-Port model unit in a standard 19-inch rack:

- 1** Check that the rack is sturdy and properly grounded. Attach the rack-mount brackets to the front or rear panel of the chassis with screws.
- 2** Place the switch on a shelf in the rack and slide it to a proper position along the guide rails, reserving a suitable clearance between the device and the guide rails.
- 3** Fix the brackets to the rack posts with screws, making sure that the device is securely attached.

Figure 17 Installing the switch in a 19-inch rack

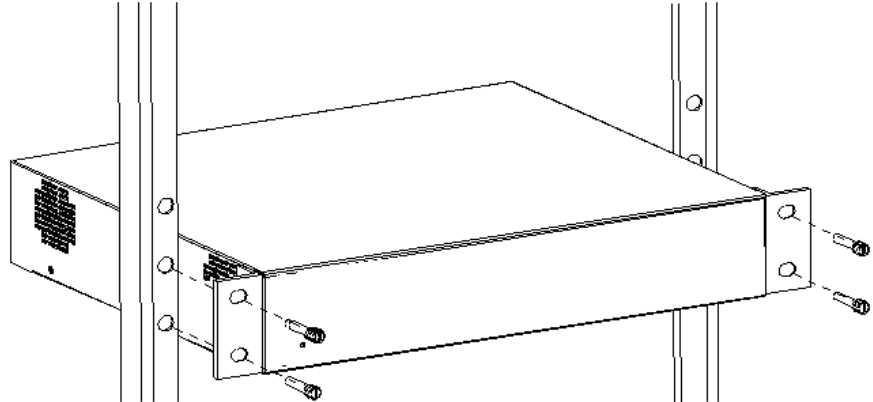

Mounting the front bracket

Mount the front bracket as shown in Figure 18 and Figure 19.

Figure 18 Mount the front bracket to the device

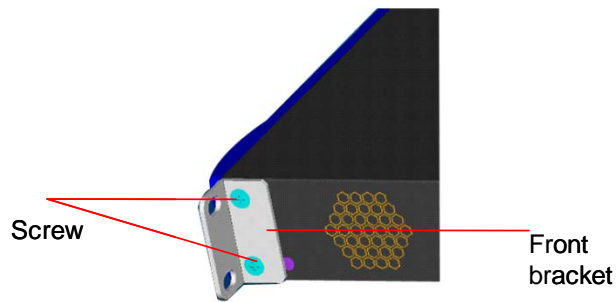
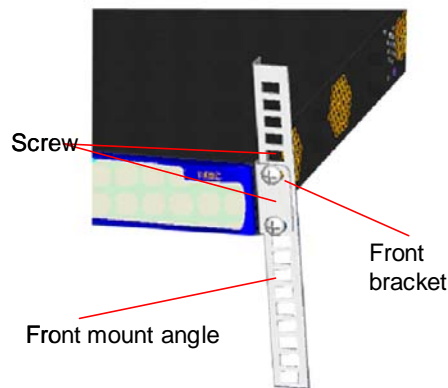

Figure 19 Mount the front bracket to the mount angel of the rack



Mounting the rear bracket

The Switch 4210 26-Port does not need rear brackets. The description for mounting rear brackets is only for the Switch 4210 PWR 24-Port.

Mount a screw on the back of the switch to closely connect the switch with the rear bracket to support the switch. There are three positions for screw mounting as shown in Figure 20.

Figure 20 Positions for screw mounting on the switch

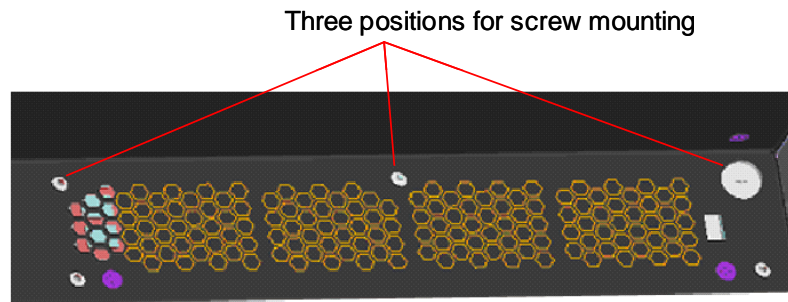

Follow the steps below to mount the rear bracket:

- 1 Use screws to fix the rear bracket to the rear mount angle.
- 2 Determine the position for screw mounting on the switch according to the position of the mount angle.
- 3 Mount the screw to the switch and make sure the screw and the rear bracket are closely connected.

Figure 21 Installation completed 1

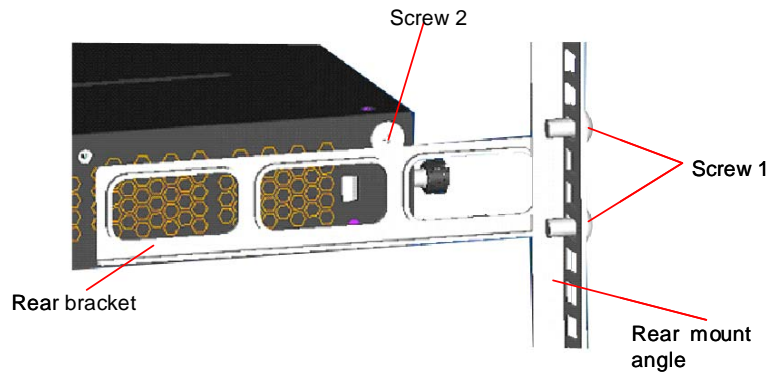

Screw 1: Fix the rear bracket to the mount angle.

Screw 2 is mounted to the switch.

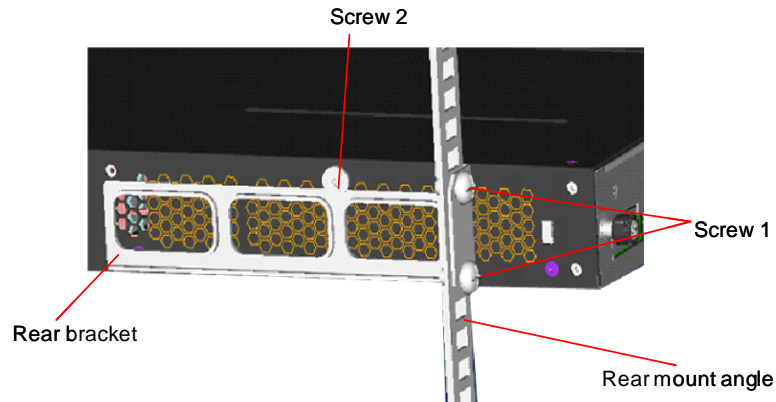
Figure 22 Installation completed 2

Screw 1: Fix the rear bracket to the mount angle.

Screw 2 is mounted to the switch.

Mounting the Switch on a Desktop

In many cases, standard 19-inch racks are not available. Therefore, switches are often placed on a desktop. To place your switch on a desktop, you simply need to:

- Make sure that the surface is clean, flat, and sturdy.
- Make sure that the environment is well ventilated and allow 10 cm (3.9 in.) of space around the chassis for heat dissipation.
- Do not place heavy objects on your switch.
- When stacking, the vertical distance between two switches must be at least 1.5 cm (0.59 in.).

The Power-up Sequence

The following sections describe how to get your Switch 4210 powered-up and ready for operation.

Powering-up the Switch 4210

Use the following sequence of steps to power-up the Switch.

- 1 Plug the power cord into the power socket at the rear of the Switch.
- 2 Plug the other end of the power cord into your power outlet.

The Switch powers-up and runs through its Power On Self Test (POST), which takes approximately one minute.

Checking for Correct Operation of LEDs

During the Power On Self Test, all ports on the Switch are disabled and the LEDs light. The PWR LED will flash green during the POST.

When the POST has completed, check the PWR LED to make sure that your Switch is operating correctly. Table 13 shows possible colors for the LED.

Table 13 PWR LED Colors

Color	State
Green	The Switch is powered-up and operating normally.
Red	The Switch has failed its Power On Self Test (POST).
Yellow flashing	Some ports have failed POST*
Off	The Switch is not receiving power.

* In this event you can still use the Switch using the remaining ports that have passed the POST.

If there is evidence of a problem, see “Solving Problems Indicated by LEDs” on page 52 for a list of suggested solutions.



CAUTION: *The Switch has no ON/OFF switch; the only method of connecting or disconnecting mains power is by connecting or disconnecting the power cord.*

Connecting a Redundant Power Supply



The Switch 4210 26-port PWR has a -48V DC Redundant Power Supply socket.

WARNING: *Only properly trained and qualified personnel should install the Redundant Power Supply (RPS).*



WARNING: *Make sure to read these instructions in conjunction with the RPS flyer and the safety and installation instructions supplied with your RPS.*



WARNING: When powering any Switch 4210 from an RPS, make sure that the unit is earthed (grounded) by either connecting the power cord to the unit or by connecting the earth terminal on the rear of the unit to a reliable electrical earth (or by connecting both). Ensure that the earth connection is made before connecting the DC supply from the RPS.

3Com switches that support -48V DC RPS inputs, and are PoE enabled, can only be powered by an RPS that complies with the isolation requirements of IEEE-Std 802.3af. Non PoE enabled switches do not have this restriction.



WARNING: Do not use a standard 'positive-earthed' -48V redundant power system suitable for use with telecommunications equipment with the 3Com Power-over-Ethernet (PoE) network switches. In order to meet the IEEE 802.3af (PoE) specification, the -48V output must be isolated from earth (ground) and meet the isolation requirements in that specification.



WARNING: Any RPS must be approved as a SELV output in accordance with IEC 60950-1/UL 60950-1/EN 60950-1.



WARNING: The characteristics of the Switch 4210 DC supply input are provided in Table 11 on page 19.

You can power the Switch 4210 using three methods:

- **AC Mains only** — this does not offer any power redundancy. If the AC mains supply or the AC power supply fails, the switch powers off.
- **AC Mains and -48V DC (primary supply)** — the internal AC supply acts as the backup in the event of a DC power failure.
- **DC only** — the switch does not need an AC supply and the resiliency is provided by the DC supply. This is useful in environments where only DC power is available.

The RPS provides two main benefits:

- **Power Redundancy** — if a switch is powered from the mains supply unit, a failure of the internal power supply causes the switch to fail. You can avoid this by connecting both the AC and DC RPS supplies to the switch. You can also add redundancy to the DC power by using (N+1) DC power supplies to further increase the availability of the system.
- **Uninterruptable Power** — the system allows easy connection and maintenance of batteries to the RPS shelf to further increase the availability of the system.

Specifying the Redundant Power System

3Com's redundant power solution allows you to use any off-the-shelf -48V DC RPS that meets the requirements defined in Table 11 on page 19.

For an approved vendor list, more details about purchasing the 3Com recommended RPS, and a full set of requirements go to:

<http://www.3Com.com/RPS>

The 3Com recommended RPS generates -48V DC power using power supply units (or rectifiers). The outputs of the rectifier(s) are connected together so that you can increase the total -48V power available by adding rectifiers. For example, three

1500W rectifiers can provide up to 4500W. Hot removal or insertion of a rectifier does not affect the -48V DC output voltage.

Table 14 shows an example of the total power available from several 1500W rectifiers.



A minimum of two rectifiers are required for each shelf to provide N+1 rectifier redundancy.

Table 14 Power Availability

	Rectifiers					
	1	2	3	4	5	6
No Rectifier Redundancy	1500W	3000W	4500W	6000W	7500W	9000W
N+1 Rectifier Redundancy	-	1500W	3000W	4500W	6000W	7500W

The unearthed -48V DC power distribution provides the mechanism to connect to the Switch 4210. The distribution consists of several circuit breakers and connection terminals for the positive (common) and negative -48V outputs. Individually connect each Switch 4210 to a circuit breaker terminal.

You can also connect a battery to battery terminals prior to the DC power distribution to provide uninterrupted power and to be protected against the loss of AC mains power.

3Com's RPS solution uses -48V DC power distribution. The RPS system provides bulk -48V DC power that is separately distributed to a number of network switches.

Each RPS consists of a shelf that can house from one to six rectifiers, a Distribution Module, and a Management Module.

Connecting the Switch to the Redundant Power System

When connecting the RPS to the switch, the circuit breaker and 2-core cables need to be matched to the switch's power rating. Table 15 shows the recommended circuit breaker and cable rating for the Switch 4210. The recommended cable length should not exceed three metres (9.84 feet).

Table 15 Switch 4210 Circuit Breaker and Cable Ratings

	Circuit Breaker	Minimum 2-Core Cable Diameter
PoE	25A C type	12 AWG (solid or stranded cable)



WARNING: Make sure to follow the RPS Manufacturers recommendations when connecting the cable to the RPS.



WARNING: Ensure that the circuit breaker in the RPS is in the open (off) position when connecting the cable to the RPS and the cable and connector to the switch.



WARNING: Ensure that the positive terminal on the switch is connected to the positive (common) terminal of the RPS and that the negative terminal on the switch is connected to the negative (circuit breaker) terminal of the RPS.

Figure 23 shows how to connect the power supply to the RPS socket in the back of the switch. Use the cable tie supplied with your switch to support the cable in the back of the RPS connector as shown in Figure 23.

Figure 23 RPS Connection to the Switch

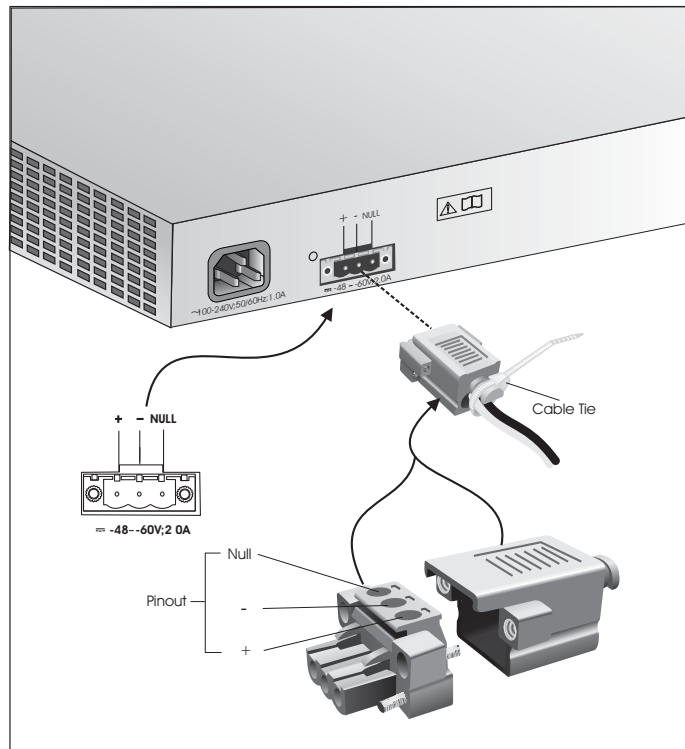

When the RPS is connected to the switch, you can move the circuit breaker in the RPS to the closed (on) position and the switch will be powered by the -48V DC power.

The -48V DC power takes priority over the AC mains and powers the switch if it is connected.

Connecting the Earthing Cable

Use the earthing cable that accompanies your switch if the length is suitable. Alternatively use the earthing cable specification as defined in "Earthing Lead" on page 20.



The earthing cable is only required if the switch is powered by the RPS only.

The recommended cable length should not exceed three meters (9.84 feet).

Using Power over Ethernet

The Switch 4210 Power over Ethernet (PoE) units can supply power to any IEEE 802.3af compliant device through any of its front panel ports over a Category 5 or Category 5e Ethernet cable. The same cable connects the device to the network.

The Switch 4210 units can supply power through the 10/100 ports only.

Power over Ethernet is a self-configuring protocol. When you plug a PoE compliant device into one of the ports on the switch, the switch supplies the

power required to the device, providing that the total power budget for the switch is not exceeded.

A PoE switch combines the functionality of a standard Ethernet switch with a single power supply that can power multiple devices. Using a PoE switch has the following advantages over an non-powered network.

- **Reduced Cabling** — a PoE (802.3af) compliant device that has its power supplied over its Ethernet cable does not require a separate power supply. If, for example, you use the switch to connect a 3Com 11 Mbps Wireless LAN Access Point 8500 to the network, then only a network cable is required to provide both power and network connectivity.
- **Increased Reliability** — a device powered by a PoE switch can take advantage of the facilities available to the switch. You can fit the switch with a redundant power supply or uninterruptible power supply to increase its uptime.

The switch supports resistor detection according to IEEE 802.3af and pre-standard detection methods.



The Switch 4210 supports 3Com 802.3af equipment. For the latest list of supported devices, refer to the product page on the 3Com web site at <http://www.3com.com/>

For additional information on Power over Ethernet, refer to the Power over Ethernet Configuration chapter in the Configuration Guide available on the 3Com Web site. Power over Ethernet management is available using the web interface or the command line interface (CLI).

Connecting the Console Cable

A Console cable is an 8-core cable. One end of the cable is a crimped RJ-45 connector for the connection to the Console port of the switch, and the other end is a DB-9 female connector for the connection to the serial port on the Console terminal, as shown in Figure 24.

Figure 24 Console cable

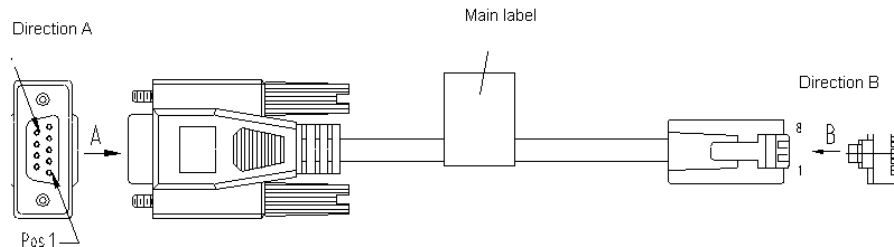

Table 16 Console cable pinouts

RJ-45	Signal	Direction	DB9 (console)
1	RTS		
2	DTR		
3	TXD	→	2

Table 16 Console cable pinouts

RJ-45	Signal	Direction	DB9 (console)
4	CD		
5	GND	—	5
6	RXD	<—	3
7	DSR		
8	CTS		

When you want to use the terminal to configure the switch, follow these steps to connect a terminal device to your switch using console cables:

- 1 Plug the DB-9 female connector of the Console cable to the serial port of the PC or terminal where the switch is to be configured.
- 2 Connect the RJ-45 connector of the Console cable to the Console port of the switch.



CAUTION: Pay attention to the mark on the Console port and be sure to plug the connector to the right port.



If the switch has been powered on:

- First connect the DB-9 connector of the Console cable to the PC before connecting the RJ-45 connector to the switch.
- Disconnect the DB-9 connector of the Console cable from the PC after disconnecting the RJ-45 connector from the switch.

3

MANAGING YOUR SWITCH

To make full use of the features offered by your switch, and to change and monitor the way it works, you have to access the management software that resides on the switch. Managing the switch can help you to improve its efficiency and therefore the overall performance of your network.

This chapter explains the initial set up of the switch and the different methods of accessing the management software to manage a switch. It covers the following topics:

- Methods of Managing a Switch
- Setting Up Your Switch
- Manually Configuring IP Information
- Viewing Automatically Configured IP Information
- Setting Up Command Line Interface Management
- Setting Up Command Line Interface Management using SSH
- Setting Up Web Interface Management
- Setting Up SNMP Management
- Default Users and Passwords



For information on the lost password procedure, refer to the Configuration Guide that is supplied with your switch.

Methods of Managing a Switch

To manage your switch you can use one of the following methods:

- Command line interface management
- Command line interface management using SSH
- Web interface management
- SNMP management

Command Line Interface Management

Each switch has a command line interface (CLI) that allows you to manage the switch from a workstation, either locally using a console port connection (see Figure 25), or remotely over the network (see Figure 26).

Figure 25 CLI Management using the Console Port

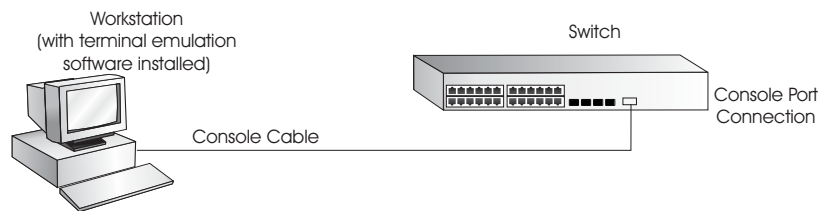
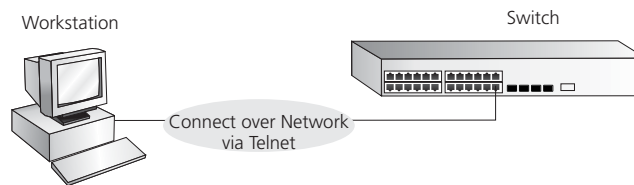

Figure 26 CLI Management over the Network



Refer to “Setting Up Command Line Interface Management” on page 47.

There are two main views in the CLI:

■ User View

This view is shown when you first connect to the switch and shows basic information about operation and statistics. The prompt for user view is `<4210>`.

■ System View

This view enables you to configure the system parameters. To display this view, from user view enter **system-view**. The prompt for system view is `[4210]`.

Command Line Interface Management using SSH

The Switch 4210 supports Secure Shell version 2.0 (SSHv2.0), allowing secure access to the switch’s Command Line Interface.

If you use SSH to administer your switch and the network traffic is intercepted, no passwords or configuration information is visible in the data. To securely administer the switch using the Command Line Interface you need a third-party SSH client.

Web Interface Management

Each switch has an internal set of web pages that allow you to manage it using a Web browser remotely over an IP network (see Figure 27).

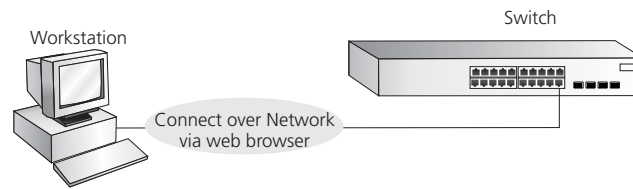
Figure 27 Web Interface Management over the Network

Refer to "Setting Up Web Interface Management" on page 48.

SNMP Management

You can manage a switch using any network management workstation running the Simple Network Management Protocol (SNMP) as shown in Figure 28. For a description of 3Com network management applications refer to "3Com Network Management" on page 63.

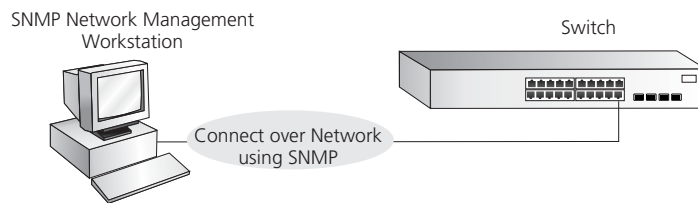
Figure 28 SNMP Management over the Network

Refer to "Setting Up SNMP Management" on page 49.

Setting Up Your Switch

This section provides an overview of what you need to do to set up your switch so that you can manage it in its default state. The setup process is summarized in Figure 29. Detailed steps are provided in the sections that follow. In brief, you need to:

- Configure IP information manually for your switch or view the automatically configured IP information
- Prepare for your chosen method of management

Figure 29 Initial Switch Setup and Management Flow Diagram

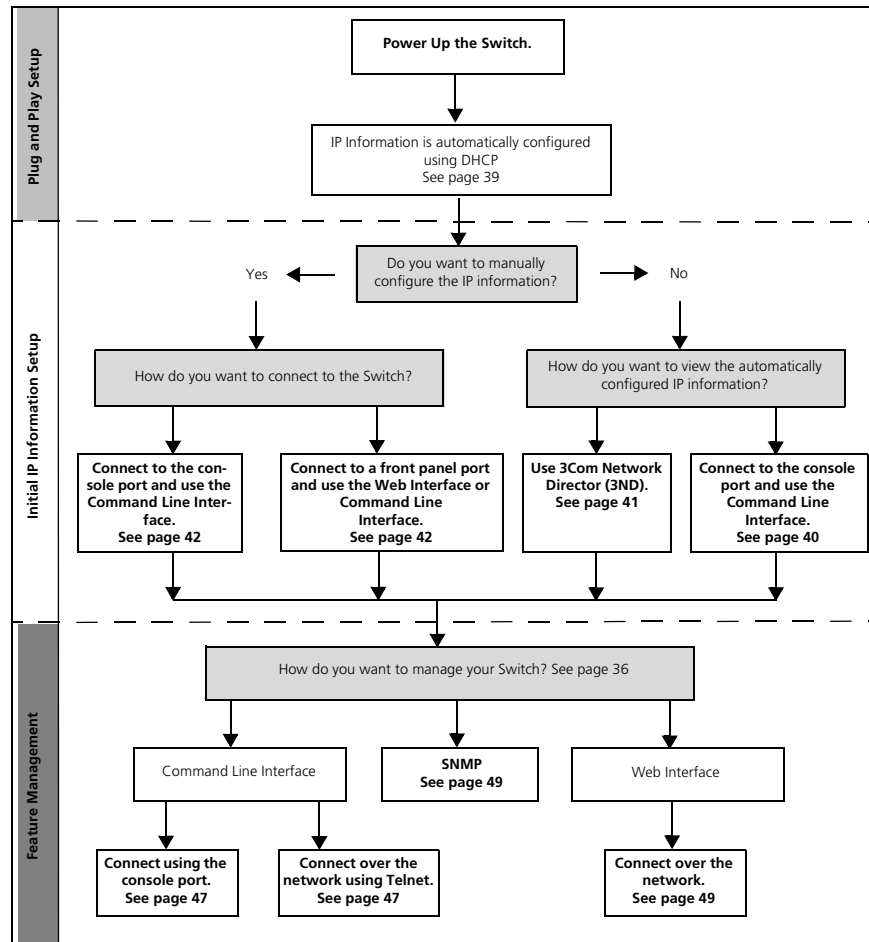

CAUTION: To protect your switch from unauthorized access, you must change all three default passwords as soon as possible, even if you do not intend to actively manage your switch. For more information on default users and changing default passwords, see “Default Users and Passwords” on page 50.

IP Configuration

In order for the device to be remotely managed, it requires an IP address. You can use one of the following methods to allocate IP information to your switch.

Configuring IP Manually

When you configure the IP information, the switch remembers the information that you enter until you change it again. You should use the Manual IP configuration method if:

- you do not have a DHCP or BootP server on your network
- you want to remove the risk of the IP address ever changing
- your DHCP or BootP server does not allow you to allocate static IP addresses. (Static IP addresses are necessary to ensure that the switch is always allocated the same IP information.)



For most installations, 3Com recommends that you assign a known IP address to your switch. This makes management simpler and more reliable as it is not

dependent on a DHCP or BootP server, and eliminates the risk of the IP address changing.

To manually enter IP information for your switch, refer to “Manually Configuring IP Information” on page 42.

Automatically Configuring the IP Address using DHCP

By default the switch attempts to obtain an IP address from a DHCP server on the network without requesting user intervention. When using automatic IP configuration, it is important that the switch’s IP address is static so that you know what it is, otherwise it will be difficult to manage that switch. Most DHCP servers allow you to configure static IP addresses. Refer to the documentation that accompanies your DHCP server.



For a detailed description of how automatic IP configuration operates, refer to the Configuration Guide on the 3Com Web Site.

You should use the automatic IP configuration method if:

- Your network uses DHCP to allocate IP information
- Flexibility is needed. If the switch is deployed on a different subnet, it automatically reconfigures itself with an appropriate IP address so that you do not have to manually reconfigure the switch.



If the switch is not allocated with an automatic IP address, the IP configuration will be blank or shown as ' ' ' ' .

If you use the automatic IP configuration method, you need to discover the automatically allocated IP information before you can begin management.

Viewing Automatically Configured IP Information

If you allow the switch to automatically configure its own IP information you need to discover and view the IP information before you can begin to manage the switch. You can discover the IP information by:

- Connecting a workstation to the switch's console port using a console cable. You can then manually enter the IP information using the command line interface (CLI).
- Using Network Director or 3Com Network Supervisor. These applications auto-discover the switch and display the automatically allocated IP information assigned to the switch.
- Reviewing information in your DHCP Server. The DHCP server in your network may log IP address assignments. By reviewing this log, you may be able to determine the device's IP address. Refer to your DHCP Server documentation for details.

Connecting to the Console Port

You can view the automatically configured IP information using the command line interface (CLI) through a connection to the console port. This example describes a local connection to the console port, rather than a remote one using a modem. For further information on connecting using the console port see "Connecting the Workstation to the Switch" on page 42.

Viewing IP Information using the Console Port

You are now ready to view the automatically allocated IP information using the command line interface. To do so:

- 1 Connect your switch to the network using the Ethernet cable. As soon as a network connection is made the switch begins the automatic IP configuration process.



The automatic IP configuration process usually completes within one minute.

- 2 The CLI login sequence begins as soon as the switch detects a connection to its console port.



*If the login prompt does not begin immediately, press **Return** a few times until it starts.*

- 3 At the login and password prompts, enter **admin** as your user name and press **Return** at the password prompt. If you have logged on correctly, <4210> is displayed as shown in Figure 30.

Figure 30 User View Login

```

*****
*      all rights reserved (1997-2005)      *
*      Without the owner's prior written consent,      *
*no decompiling or reverse-engineering shall be allowed.*
*****

Login authentication

Username:admin
Password:
<4500>
%Apr  5 17:22:13:289 2000 4500 SHELL/5/LOGIN:- 1 - admin<161.71.164.118> in unit
1 login_

```

- 4 Enter **display ip interface br** to view a summary of allocated IP addresses.

The initial set up of your switch is now complete and you can now set up a management method. See “Methods of Managing a Switch” on page 36 for details.

If you do not intend to use the CLI from the console port to manage the switch, you can logout, disconnect the serial cable, and close the terminal emulator software.

Using 3Com Network Director or 3Com Network Supervisor

3Com has two management applications that will discover and help you manage your network. 3Com Network Supervisor is freely distributed PC software ideal for monitoring your network. It discovers your devices and connections, alerts you to network or configuration issues, assists you in registering your devices, and proactively monitors the health of your network.

3Com Network Director is chargeable PC software that adds advanced configuration and control to the features available from 3Com Network Supervisor.

Trial versions of both products are available at www.3com.com.

You can use 3Com Network Supervisor or 3Com Network Director to discover the automatically allocated IP information. To do so:

- 1 Connect your switch to the network.
- 2 Launch 3Com Network Director or Network Supervisor and run the auto-discovery wizard.

The application discovers the new switch and displays the IP information that has been automatically allocated to the switch.

- 3 Power-up the switch and wait two minutes.



Most DHCP and BootP servers allow you to configure static IP addresses so that you know the switch's IP address. Refer to the documentation that accompanies your DHCP or BootP server for more information on this topic.



If your network does not have a DHCP or BootP server, the workstation running 3Com Network Supervisor or 3Com Network Director must be on the same subnet as the switch because auto-IP addresses are not routable.

Manually Configuring IP Information

You can manually configure the switch IP information by:

- Connecting a workstation to the switch's console port using a console cable. You can then manually enter the IP information using the command line interface (CLI). This is the only way to assign an IP address to a device that does not have an IP address already, or that has an unknown IP address. You can also use this method to change switch's IP information.
- Connecting a workstation to one of the ports on the switch's front panel using an Ethernet cable. You can then manually enter the IP information using the web interface or the command line interface. This is only applicable if the device already has an IP address and you know that address.

Connecting to the Console Port

To set up your switch manually you can make a connection to the console port, (this example describes a local connection to the console port, rather than one using a modem). You can do this while the switch is offline (before you connect the switch to a network) or while the switch is online (connected to a network).

Prerequisites

- A workstation with terminal emulation software installed, such as Microsoft Hyperterminal. This software allows you to communicate with the switch using the console port directly.
- Documentation supplied with the terminal emulation software.
- The console cable (RJ-45) supplied with your switch.



You can find pin-out diagrams for the cable in "Pin-outs" on page 57.

- IP information, including:
 - IP address
 - subnet mask
 - default gateway
 - management VLAN ID, normally set to the default value (1)

Connecting the Workstation to the Switch

To connect the workstation to the switch, perform the following steps:

- 1 Connect the workstation to the console port using the console cable as shown in Figure 31.

Figure 31 Connecting a Workstation to the Switch using the Console Port

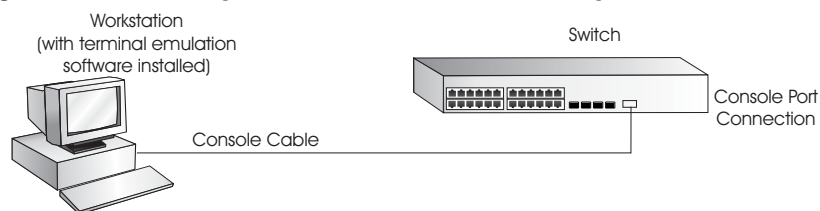

To connect the cable:

- a Attach the RJ-45 connector on the cable to the console port of the switch.
- b Attach the other end of the cable to the workstation and tighten the retaining screws on the cable to prevent it from being loosened.

- 2 Open your terminal emulation software and configure the COM port settings to which you have connected the cable. The settings must be set to match the default settings for the switch, which are:
 - 19,200 baud (bits per second)
 - 8 data bits
 - no parity
 - 1 stop bit
 - no hardware flow control

Refer to the documentation that accompanies the terminal emulation software for more information.
- 3 Power up the switch. The Power on Self Test (POST) runs automatically. The Switch 4210 takes approximately one minute to boot.

Setting Up the Switch with IP Information

To manually set up the switch with IP information using the command line interface perform the following steps

- 1 The command line interface login sequence begins as soon as the switch detects a connection to its console port.



If the login prompt does not begin immediately, press Return a few times until it starts.

- 2 At the login prompts, enter **admin** as your user name and press Return and at the password prompt press Return again. If you have logged on correctly, <4210> appears as shown below.



Once you have logged in you are automatically in User View.

```
*****
*
*          Switch 4210 9-Port BOOTROM, Version 4.01          *
*
*****
```

```
Copyright (c) 2004-2007 3Com Corporation and its licensors.
Creation date   : May 29 2007, 19:14:41
CPU Clock Speed : 200MHz
BUS Clock Speed : 33MHz
Memory Size    : 64MB
Mac Address     : 001ac16d080a
```

```
Press Ctrl-B to enter Boot Menu... 0
Auto-booting...
Decompress Image.....
.....
.....
.....OK!
Starting at 0x80100000...
```

User interface aux0 is available.

Press ENTER to get started.

Login authentication

Username:admin

Password:

<4210>

```
%Apr 1 23:57:15:490 2000 4210 SHELL/5/LOGIN:- 1 - admin(aux0) in
unit1 login
```

<4210>

- 3 Enter the **system-view** command and press Enter. The [4210] prompt is displayed.



- 4 Enter **interface vlan 1** and press Enter.

- 5 Enter the IP address and subnet mask for the switch as follows:

```
ip address xxx.xxx.xxx.xxx mmm.mmm.mmm.mmm
```

and press Enter.

(where xxx.xxx.xxx.xxx is the IP address and mmm.mmm.mmm.mmm is the subnet mask of the switch)

- 6 Select the **quit** command and enter the default gateway for the switch:

```
ip route-static 0.0.0.0 0.0.0.0 xxx.xxx.xxx.xxx
```

(where xxx.xxx.xxx.xxx is the IP address of the default gateway)

- 7 From the User View, type **save** to save the switch's configuration (this information is not saved automatically when the switch is powered down).

You can now set up your chosen management method. See "Methods of Managing a Switch" on page 36.

If you do not intend to use the command line interface using the console port to manage the switch, you can disconnect the serial cable and close the terminal emulator software.

Connecting to a Front Panel Port

You can manage your switch, including changing IP address information, by making a connection to a front panel port. You can then access the Command Line Interface or the Web interface, as desired. To do this you will need an IP address, refer to "Viewing Automatically Configured IP Information" on page 40 for more information.



The procedure described in this section assumes the unit has been powered up in standalone mode.

Prerequisites

- A workstation running a suitable operating system. Refer to "Choosing a Browser" on page 48.
- A Network Interface Card (NIC).
- A Category 5 twisted pair Ethernet cable with RJ-45 connectors at both ends.

- A suitable Web browser. Refer to “Choosing a Browser” on page 48.
- Existing IP address of the switch.
- The switch’s IP information, including the:
 - IP address
 - subnet mask
 - default gateway
 - management VLAN ID, normally set to the default value (1)

Connecting the Workstation to the Switch

- 1 Connect the workstation to a front panel port using an Ethernet cable as shown in Figure 32.

Figure 32 Connecting a Workstation to the Switch using a Front Panel Port

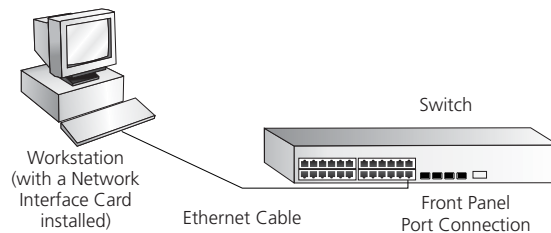

To connect the cable:

- a Attach an RJ-45 connector at one end of the Ethernet cable to the Network Interface Card (NIC) in the workstation.
- b Connect the RJ-45 connector at the other end of the cable to one of the front panel ports on the switch.



Do not interconnect the switch to any other unconfigured switch.

Setting Up the Switch with IP Information

You can now review or change the switch’s IP information. You can do this using the Web interface or the command line interface (CLI) using telnet.

Using the Web Interface

- 1 Power-up the switch. This takes approximately one minute.
- 2 Open a suitable Web browser and enter the IP address of your switch in the Address field.



If there is no response, wait for one minute then re-enter the IP address.



If a pop up message appears displaying download and install simplified Chinese information, click Cancel.

- 3 At the login prompt, enter **admin** as your user name, press Enter, and at the password prompt (default user name and password) press Enter again. If you have logged on correctly, the Device View of the switch is displayed.
- 4 To enter basic setup information for the switch, select **Administration > IP Setup** and then follow the wizard through various system screens to enter the IP

address and subnet mask that you want the switch to use when it is connected to the network. The final page displays a summary of the information entered.

- 5 Select **Save Configuration** to save the configuration to your switch.

The initial setup of your switch is now complete and you can now set up your chosen management method. See “Methods of Managing a Switch” on page 36.

Using Command Line Interface using Telnet

- 1 To start a Telnet session to the unit, click **Start** in Microsoft Windows.

- a Click **Run**.

- b In the Open field, type the unit's IP address:

Telnet xxx.xxx.xxx.xxx

(where xxx.xxx.xxx.xxx is the switch's IP address)

- c Click **OK**.

- 2 Press Enter to open a login prompt.



If the login prompt does not begin immediately, press Return a few times until it starts.

- 3 At the login prompt, enter **admin** as your user name and press Return at the password prompt. If you have logged on correctly, <4210> is displayed as shown below.

```
*****
* Copyright (c) 2004-2007 3Com Corp. and its licensors. All rights reserved.*
* Without the owner's prior written consent, *
* no decompiling or reverse-engineering shall be allowed. *
*****
```

Login authentication

Username: admin

Password:

<4210>

%Apr 4 06:13:31:519 2000 4210 SHELL/5/LOGIN:- 1 - admin(10.10.11.222) in

unit1 login

<4210>

- 4 Enter the **system-view** command and Enter.
- 5 Enter **interface vlan 1** and Enter.
- 6 Enter the IP address and subnet mask for the switch as follows:

ip address xxx.xxx.xxx.xxx mmm.mmm.mmm.mmm

(where xxx.xxx.xxx.xxx is the IP address and mmm.mmm.mmm.mmm is the subnet mask of the switch)

- 7 Enter the default gateway for the switch:

ip route-static 0.0.0.0 0.0.0.0 xxx.xxx.xxx.xxx

(where xxx.xxx.xxx.xxx is the IP address of the default gateway)

- 8 Enter the **save** command to save the configuration (the configuration is not saved automatically when the switch is powered down).

The initial set up of your switch is now complete and you can set up your management method. See “Methods of Managing a Switch” on page 36.

Setting Up Command Line Interface Management

This section describes how you can set up command line interface management using a local console port connection or over the network.

User Interface Overview

User interface configuration is provided by the switch to configure and manage the port data. There are two types of user interfaces:

- AUX User Interface—used to log in to your switch using the console port. A fabric can have up to one AUX user interface.
- VTY User Interface—used to Telnet to the switch. The switch can have up to five VTY user interfaces.

CLI Management using the Console Port

To manage a switch using the command line interface using the local console port connection:

- 1 Ensure you have connected your workstation to the console port correctly as described in “Connecting to the Console Port” on page 42.
- 2 Your switch is now ready to continue being managed and/or configured through the CLI using its console port.

CLI Management over the Network

To manage a switch using the command line interface over a network using Telnet:

- 1 Ensure you have already set up the switch with IP information as described in “Methods of Managing a Switch” on page 36.
- 2 Check that you have the IP protocol correctly installed on your management workstation. You can check this by trying to browse the World Wide Web. If you can browse, the IP protocol is installed.
- 3 Check you can communicate with the switch by entering a **ping** command at the DOS prompt in the following format:

```
c:\ ping xxx.xxx.xxx.xxx
(where xxx.xxx.xxx.xxx is the IP address of the switch)
```

If you get an error message, check that your IP information was entered correctly and the switch is powered up.

- 4 To open a Telnet session using the DOS prompt, enter the IP address of the switch that you wish to manage in the following format:

```
>telnet xxx.xxx.xxx.xxx
(where xxx.xxx.xxx.xxx is the IP address of the switch)
```



If opening a Telnet session using third party software you will need to enter the IP address in the format suitable for that software.

- 5 At the login and password prompts, enter **admin** as your user name and press Return at the password prompt (or the password of your choice if you have already modified the default passwords).



If the login prompt does not display immediately, press Return a few times until it starts.

- 6 If you have logged on correctly, the switch you want to manage is displayed as <4210>, as shown in on page 44.

Setting Up Command Line Interface Management using SSH

To set up command line interface management using SSH, refer to the chapter entitled “SSH Configuration” in the “3Com Switch 4210 Family Configuration Guide.”

Setting Up Web Interface Management

This section describes how you can set up web interface management over the network.

- Prerequisites**
- Ensure that you have already set up the switch with IP information as described in “Methods of Managing a Switch” on page 36.
 - Ensure that the switch is connected to the network using a Category 5 twisted pair Ethernet cable with RJ-45 connectors.
 - A suitable Web browser.

Choosing a Browser

To display the web interface correctly, use one of the following Web browser and platform combinations:

Table 17 Supported Web Browsers and Platforms

Browser	Platform				
	Windows 2000	Windows XP	Windows Server 2003	Red Hat Linux 9	Solaris 7/9
Netscape 7.1	Yes	Yes	No	No	Yes
Internet Explorer 5.5	Yes	Yes	Yes	No	No
Internet Explorer 6.0	Yes	Yes	Yes	No	No
Mozilla 1.4	No	No	No	Yes	Yes

For the browser to operate the web interface correctly, JavaScript™ and Cascading Style Sheets must be enabled on your browser. These features are enabled on a browser by default. You will only need to enable them if you have changed your browser settings.

Web Management Over the Network

To manage a switch using the web interface over an IP network:

- 1 Check that you have the IP protocol correctly installed on your management workstation. You can check this by trying to browse the World Wide Web. If you can browse, the IP protocol is installed.
- 2 Check you can communicate with the switch by entering a **ping** command at the DOS prompt in the following format:

```
c:\ ping xxx.xxx.xxx.xxx
```

 (where xxx.xxx.xxx.xxx is the IP address of the switch)

If you get an error message, check that your IP information was entered correctly and the switch is powered up.
- 3 Open your web browser and enter the IP address of the switch that you wish to manage in the URL locator, for example, in the following format:

```
http://xxx.xxx.xxx.xxx
```
- 4 At the login and password prompts, enter **admin** as your user name and press Return at the password prompt (or the password of your choice if you have already modified the default passwords).
- 5 Click on the **Device View** button to display the web management options.

Setting Up SNMP Management

Any network management application running the Simple Network Management Protocol (SNMP) can manage a switch if the management workstation is connected to the switch using a port on the management VLAN. By default, the management VLAN is 1, and all ports on the switch are in VLAN 1.



For a description of 3Com's network management applications, see Appendix C, "3Com Network Management" on page 63.

Prerequisites

- The default read community string is public. The default write community string is private.
- To display the current configuration of the community strings in the System View, enter **display snmp-agent community**.
- To configure new read community strings, enter **snmp community read** (new community string up to 32 characters).
- To configure new write community strings, enter **snmp community write** (new community string up to 32 characters).
- To remove a community string, enter **undo snmp-agent community** (the string to be removed).



*To manage your switch using an SNMP network management application, you need to specify SNMP community strings for the users defined on the switch. You can do this using the command line interface **system management snmp community** command. Refer to the command line interface section of the "SuperStack 4 Switch Command Reference Guide" for more information.*



These switches support SNMP V1, V2, and V3. SNMP V3 is on as default. All commands are in snmp menu in System View.

Default Users and Passwords

If you intend to manage the switch using the web interface or the command line interface, or to change the default passwords, you need to log in with a valid user name and password. The switch has three default user names, and each user name has a different password and level of access. These default users are listed in Table 18.



CAUTION: *To protect your switch from unauthorized access, you must change all three default passwords as soon as possible, even if you do not intend to actively manage your switch.*

Table 18 Default Users

User Name	Default Password	Access Level
monitor	monitor	monitor The user can view all manageable parameters, except special/security features, but cannot change any manageable parameters
manager	manager	manager The user can access and change the operational parameters but not special/security features
admin	(no password)	security The user can access and change all manageable parameters



Use the admin default user name (no password) to login and carry out initial switch setup.

To set a password for the admin user in the CLI, enter the following from system view:

```
[4210]local-user admin <cr>
[4210-luser-admin]password simple xxxxxxxx
```

(where **xxxxxxx** is your chosen password).

Save the configuration in the User View.



For information on the lost password procedure refer to the Configuration Guide that is supplied with your switch.

4

PROBLEM SOLVING

This chapter helps you to diagnose and solve problems you may have with the operation of your switch. There is also an explanation of IP addressing and upgrading software.

The topics covered are:

- Solving Problems Indicated by LEDs
- Solving Hardware Problems
- Solving Communication Problems
- Solving Fabric Formation Problems

If you experience a problem that is not listed here, it may be included in the Support section of the switch *4210 Command Reference Guide* available on 3Com's web site at www.3com.com.

For Technical Support information, see "Obtaining Support for Your 3Com Products" on page 59.

Solving Problems Indicated by LEDs

If the LEDs on the switch indicate a problem, refer to the list of suggested solutions below.

The PWR LED does not light

Check that the power cable is firmly connected to the switch and to the supply outlet. If the connection is secure and there is still no power, you may have a faulty power cord or an internal fault. Check the power cord by:

- Testing it in another device.
- Connecting a working power cord to the 'problem' device and contact your supplier for advice.

On powering-up, the PWR LED lights Red

The switch unit has failed its Power On Self Test (POST) because of an internal problem. The fault type will be indicated on the unit LEDs. Contact your supplier for advice.

On powering-up, the PWR LED is flashing yellow

A port has failed and has been automatically disabled. You can verify this by checking that the Port LED is quickly flashing Yellow. If a port fails, the switch passes its Power On Self Test and continues to operate normally.

A Port LED is flashing yellow

The port has failed and has been automatically disabled. The switch passes its Power On Self Test and continues to operate normally, even if one or more ports are disabled.

A link is connected and yet the Port LED does not light

Check that:

- The switch and the device at the other end of the link (or cable) are connected securely.
- The devices at both ends of the link are powered-up
- The quality of cable is satisfactory
- Auto-negotiation settings are the same at both ends.

Auto-negotiation problems will occur with 10BASE-T or 100BASE-T where auto-negotiation is disabled and incorrect cables are being used (cross-over or straight).

Auto-negotiation problems will occur with fiber if:

- The Receiver (RX) and Transceiver (TX) cable connectors are swapped
- Fibers are broken
- Auto-negotiation differs at either end (a link appears at the 'fixed' end and not at the auto-negotiation end)

Solving Hardware Problems

In the rare event of your switch unit experiencing a hardware failure, refer to the list of suggested solutions below.

A fan failure warning message is received

Your switch has a fan monitoring system that will generate fan failure warning messages. Fan failure could potentially reduce the lifetime of the switch. The monitoring system polls the fan status at periodic intervals while the unit is powered up.

If one fan has failed in the switch, a warning message will be generated in the following ways:

- **Unit LED**

The seven segment display will show a green flashing 'f'.

- **RMON Trap**

If configured, an RMON trap is generated and sent to the management workstation.

- **Command Line Interface**

An indication of a general hardware failure is provided through the Top level menu displayed when logging on to the CLI. For more detailed information about the failure select the **display logbuffer** command.

- **Web interface**

An indication of fan failure is provided through the Device Summary table for the specific unit. In addition all Summary tables turn red to indicate the fan failure.

If a fan failure warning message is generated:

- 1 Power off the unit.
- 2 Check that the air vents are not obstructed.
- 3 Power cycle the unit. To do this, remove and reconnect the AC mains supply. If another fan failure warning message is generated using the Command Line Interface or the Web interface, return the unit to 3Com.

Unit fails, no SNMP fan failure message is received

- 1 Power cycle the unit. To do this, remove and reconnect the AC mains supply.
- 2 Check the command line interface (**display logbuffer** command) to determine whether a thermal shutdown has occurred.
- 3 If no, return the unit:

If yes, check that:

- The air vents are not obstructed.
 - The ambient temperatures and environmental conditions meet those specified in "Technical Specifications" on page 73.
- 4 Power cycle the unit. If a further thermal shutdown occurs, and all environmental conditions are satisfactory, return the unit to 3Com.

Error message indicating that the SFP transceiver is invalid

The switch has identified that the SFP does not meet the minimum requirements for the switch and has disabled the port. To correct this problem, completely remove the SFP and replace it with a 3Com approved SFP.

Error message indicating that the SFP transceiver is faulty

To correct this problem, completely remove the SFP and then reinsert it. Alternatively, insert another identical SFP. If the problem persists, contact 3Com Technical Support.

**Solving
Communication
Problems**

If you experience communication problems with the switch, ensure that:

- The switch IP address and Management VLAN ID has been configured.
- If the switch is separated from your management application by a router, ensure that the default gateway IP address within the switch is the same as the IP address of the router.
- The switch's IP address was discovered correctly by your network management application.

The following is a brief overview of IP addressing, and how to obtain a registered IP address.

IP Addressing

To be managed correctly, each device on your network (for example a switch or Hub) must have a unique IP address. IP addresses have the format *n.n.n.n* where *n* is a decimal number between 0 and 255. An example IP address is 192.168.100.8.

The IP address is split into two parts:

- The first part ('192.168.100' in the example) identifies the network on which the device resides
- The second part ('.8' in the example) identifies the device within the network

The natural subnet mask for this example is 255.255.255.0.



If your network has a connection to the external IP network, that is, you access the Internet, you must apply for a registered IP address.

How do you obtain a registered IP Address?

The IP registration system ensures that every IP address used is unique; if you do not have a registered IP address, you may be using an identical address to someone else and your network will not operate correctly.

InterNIC Registration Services is the organization responsible for supplying registered IP addresses. The following contact information is correct at time of publication:

World Wide Web site: <http://www.internic.net>

If your IP network is internal to your organization only, that is, you do not access the Internet, you may use any arbitrary IP address as long as it is not being used by

another device on your network. 3Com suggests you use addresses in the range 192.168.0.0 to 192.168.255.255 with a subnet mask of 255.255.255.0.



These suggested IP addresses are part of a group of IP addresses that have been set aside specially for use 'in house' only.

Solving Fabric Formation Problems

If you are having problems with correctly forming a fabric, first ensure that Spanning Tree is enabled. If it is enabled, do the following:

- 1** Power off all units in the fabric.
- 2** Check all the cable connections in the fabric.
- 3** Check the ports have been enabled as fabric ports.
- 4** Power on all units in the fabric.

A

PIN-OUTS

Null Modem Cable

RJ-45 to RS-232 25-pin

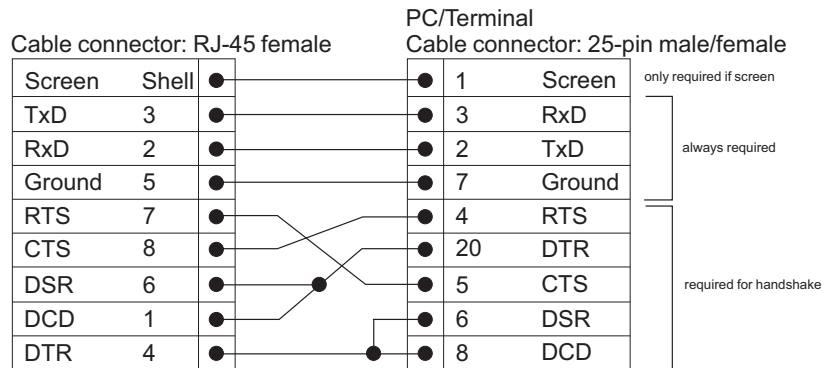

PC-AT Serial Cable

RJ-45 to 9-pin

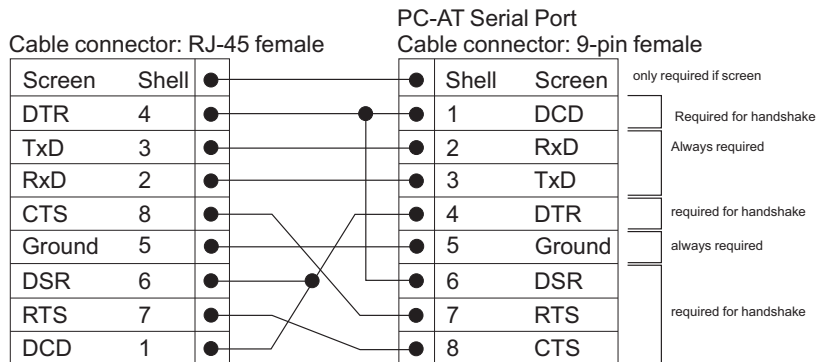

Modem Cable

RJ-45 to RS-232 25-pin

Cable connector: RJ-45 female			RS-232 Modem Port Cable connector: 25-pin male		
Screen	Shell	●	●	1	Screen
TxD	3	●	●	2	TxD
RxD	2	●	●	3	RxD
RTS	7	●	●	4	RTS
CTS	8	●	●	5	CTS
DSR	6	●	●	6	DSR
Ground	5	●	●	7	Ground
DCD	1	●	●	8	DCD
DTR	4	●	●	20	DTR

**Ethernet Port RJ-45
Pin Assignments**

10/100 and 1000BASE-T RJ-45 connections.

Table 10 Pin assignments

Pin Number	10/100	1000
<i>Ports configured as MDI</i>		
1	Transmit Data +	Bidirectional Data A+
2	Transmit Data –	Bidirectional Data A–
3	Receive Data +	Bidirectional Data B+
4	Not assigned	Bidirectional Data C+
5	Not assigned	Bidirectional Data C–
6	Receive Data –	Bidirectional Data B–
7	Not assigned	Bidirectional Data D+
8	Not assigned	Bidirectional Data D–

Table 11 Pin assignments

Pin Number	10/100	1000
<i>Ports configured as MDIX</i>		
1	Receive Data +	Bidirectional Data B+
2	Receive Data –	Bidirectional Data B–
3	Transmit Data +	Bidirectional Data A+
4	Not assigned	Bidirectional Data A–
5	Not assigned	Bidirectional Data D+
6	Transmit Data –	Bidirectional Data D–
7	Not assigned	Bidirectional Data C+
8	Not assigned	Bidirectional Data C–

B

OBTAINING SUPPORT FOR YOUR 3COM PRODUCTS

3Com offers product registration, case management, and repair services through eSupport.3com.com. You must have a user name and password to access these services, which are described in this appendix.

Register Your Product to Gain Service Benefits

To take advantage of warranty and other service benefits, you must first register your product at:

<http://eSupport.3com.com/>

3Com eSupport services are based on accounts that are created or that you are authorized to access.

Solve Problems Online

3Com offers the following support tool:

- **3Com Knowledgebase** — Helps you to troubleshoot 3Com products. This query-based interactive tool is located at:

<http://knowledgebase.3com.com>

It contains thousands of technical solutions written by 3Com support engineers.

Purchase Extended Warranty and Professional Services

To enhance response times or extend your warranty benefits, you can purchase value-added services such as 24x7 telephone technical support, software upgrades, onsite assistance, or advanced hardware replacement.

Experienced engineers are available to manage your installation with minimal disruption to your network. Expert assessment and implementation services are offered to fill resource gaps and ensure the success of your networking projects. For more information on 3Com Extended Warranty and Professional Services, see:

<http://www.3com.com/>

Contact your authorized 3Com reseller or 3Com for additional product and support information. See the table of access numbers later in this appendix.

Access Software Downloads

You are entitled to *bug fix / maintenance releases* for the version of software that you initially purchased with your 3Com product. To obtain access to this software, you need to register your product and then use the Serial Number as your login. Restricted Software is available at:

<http://eSupport.3com.com/>

To obtain software releases that *follow* the software version that you originally purchased, 3Com recommends that you buy an Express or Guardian contract, a Software Upgrades contract, or an equivalent support contract from 3Com or your reseller. Support contracts that include software upgrades cover feature enhancements, incremental functionality, and bug fixes, but they do not include software that is released by 3Com as a separately ordered product. Separately orderable software releases and licenses are listed in the 3Com Price List and are available for purchase from your 3Com reseller.

Contact Us

3Com offers telephone, internet, and e-mail access to technical support and repair services. To access these services for your region, use the appropriate telephone number, URL, or e-mail address from the table in the next section.

Telephone Technical Support and Repair

To obtain telephone support as part of your warranty and other service benefits, you must first register your product at:

<http://eSupport.3com.com/>

When you contact 3Com for assistance, please have the following information ready:

- Product model name, part number, and serial number
- A list of system hardware and software, including revision level
- Diagnostic error messages
- Details about recent configuration changes, if applicable

To send a product directly to 3Com for repair, you must first obtain a return materials authorization number (RMA). Products sent to 3Com without authorization numbers clearly marked on the outside of the package will be returned to the sender unopened, at the sender's expense. If your product is registered and under warranty, you can obtain an RMA number online at <http://eSupport.3com.com/>. First-time users must apply for a user name and password.

Telephone numbers are correct at the time of publication. Find a current directory of 3Com resources by region at:
<http://csoweb4.3com.com/contactus/>

Country	Telephone Number	Country	Telephone Number
Asia, Pacific Rim — Telephone Technical Support and Repair			
Australia	1800 075 316	Philippines	1800 144 10220 or 029003078
Hong Kong	2907 0456	PR of China	800 810 0504
India	000 800 440 1193	Singapore	800 616 1463
Indonesia	001 803 852 9825	South. Korea	080 698 0880
Japan	03 3507 5984	Taiwan	00801 444 318
Malaysia	1800 812 612	Thailand	001 800 441 2152
New Zealand	0800 450 454		
Pakistan Call the U.S. direct by dialing 00 800 01001, then dialing 800 763 6780			
Sri Lanka Call the U.S. direct by dialing 02 430 430, then dialing 800 763 6780			
Vietnam Call the U.S. direct by dialing 1 201 0288, then dialing 800 763 6780			
You can also obtain non-urgent support in this region at this email address apr_technical_support@3com.com Or request a return material authorization number (RMA) by FAX using this number: +61 2 9937 5048, or send an email at this email address: ap_rma_request@3com.com			

Europe, Middle East, and Africa — Telephone Technical Support and Repair

From anywhere in these regions not listed below, call: +44 1442 435529

From the following countries, call the appropriate number:

Country	Telephone Number	Country	Telephone Number
Austria	0800 297 468	Luxembourg	800 23625
Belgium	0800 71429	Netherlands	0800 0227788
Denmark	800 17309	Norway	800 11376
Finland	0800 113153	Poland	00800 4411 357
France	0800 917959	Portugal	800 831416
Germany	0800 182 1502	South Africa	0800 995 014
Hungary	06800 12813	Spain	900 938 919
Ireland	1 800 553 117	Sweden	020 795 482
Israel	180 945 3794	Switzerland	0800 553 072
Italy	800 879489	U.K.	0800 096 3266

You can also obtain support in this region using this URL: <http://emea.3com.com/support/email.html>

You can also obtain non-urgent support in this region at these email addresses:

Technical support and general requests: customer_support@3com.com

Return material authorization: warranty_repair@3com.com

Contract requests: emea_contract@3com.com

Latin America — Telephone Technical Support and Repair

Antigua	1 800 988 2112	Guatemala	AT&T +800 998 2112
Argentina	0 810 444 3COM	Haiti	57 1 657 0888
Aruba	1 800 998 2112	Honduras	AT&T +800 998 2112
Bahamas	1 800 998 2112	Jamaica	1 800 998 2112
Barbados	1 800 998 2112	Martinique	571 657 0888
Belize	52 5 201 0010	Mexico	01 800 849CARE
Bermuda	1 800 998 2112	Nicaragua	AT&T +800 998 2112
Bonaire	1 800 998 2112	Panama	AT&T +800 998 2112
Brazil	0800 13 3COM	Paraguay	54 11 4894 1888
Cayman	1 800 998 2112	Peru	AT&T +800 998 2112
Chile	AT&T +800 998 2112	Puerto Rico	1 800 998 2112
Colombia	AT&T +800 998 2112	Salvador	AT&T +800 998 2112
Costa Rica	AT&T +800 998 2112	Trinidad and Tobago	1 800 998 2112
Curacao	1 800 998 2112	Uruguay	AT&T +800 998 2112
Ecuador	AT&T +800 998 2112	Venezuela	AT&T +800 998 2112
Dominican Republic	AT&T +800 998 2112	Virgin Islands	57 1 657 0888

You can also obtain support in this region in the following ways:

- Spanish speakers, enter the URL: <http://lat.3com.com/lat/support/form.html>
- Portuguese speakers, enter the URL: <http://lat.3com.com/br/support/form.html>
- English speakers in Latin America, send e-mail to: lat_support_anc@3com.com

US and Canada — Telephone Technical Support and Repair

All locations: All 3Com products: 1 800 876 3266

C

3COM NETWORK MANAGEMENT

3Com has a range of network management applications to address networks of all sizes and complexity, from small and medium businesses through large enterprises. The applications include:

- 3Com Network Supervisor
- 3Com Network Director
- 3Com Network Access Manager
- 3Com Enterprise Management Suite
- Integration Kit with HP OpenView Network Node Manager

Details of these and other 3Com Network Management Solutions can be found at www.3com.com/network_management

3Com Network Supervisor

3Com® Network Supervisor (3NS) is an easy-to-use management application that graphically discovers, maps, and monitors the network and links. It maps devices and connections so you can easily:

- Monitor stress levels
- Set thresholds and alerts
- View network events
- Generate reports in user-defined formats
- Launch embedded device configuration tools

3NS is configured with intelligent defaults and the ability to detect network misconfigurations. It can also offer optimization suggestions, making this application ideal for network managers with all levels of experience.

To find out more about 3Com Network Supervisor and to download a trial version, go to: www.3com.com/3ns

3Com Network Director

3Com Network Director (3ND) is a standalone application that allows you to carry out key management and administrative tasks on midsized networks. By using 3ND you can discover, map, and monitor all your 3Com devices on the network. It simplifies tasks such as backup and restore for 3Com device configurations as well as firmware and agent upgrades. 3ND makes it easy to roll out network-wide configuration changes with its intelligent VLAN configuration tools and the powerful template based configuration tools. Detailed statistical monitoring and historical reporting give you visibility into how your network is performing.

To find out more about how 3Com Network Director can help you manage your 3Com network and to download a trial version, go to: www.3com.com/3nd

3Com Network Access Manager

3Com Network Access Manager is installed seamlessly into Microsoft Active Directory and Internet Authentication Service (IAS). It simplifies the task of securing the network perimeter by allowing the administrator to easily control network access directly from the "Users and Computers" console in Microsoft Active Directory. With a single click, a user (or even an entire department) can be moved to a different VLAN, or a computer can be blocked from connecting to the network.

3Com Network Access Manager leverages the advanced desktop security capabilities of 3Com switches and wireless access points (using IEEE 802.1X or RADA desktop authentication) to control both user and computer access to the network.

To find out more about 3Com Network Access Manager, go to: www.3com.com/NAM

3Com Enterprise Management Suite

3Com Enterprise Management Suite (EMS) delivers comprehensive management that is flexible and scalable enough to meet the needs of the largest enterprises and advanced networks.

This solution provides particularly powerful configuration and change control functionalities, including the capability to:

- Customize scheduled bulk operations
- Create a detailed audit trail of all network changes
- Support multiple distributed IT users with varying access levels and individualized network resource control

The client-server offering operates on Windows and UNIX (Linux and Solaris) systems.

3Com EMS is available in four packages, varying in the maximum number of devices actively managed. These include SNMP-capable devices such as switches, routers, security switches, the 3Com VCX™ IP Telephony server, and wireless access points:

- Up to 250 devices
- Up to 1,000 devices
- Up to 5,000 devices
- An unlimited number of devices

To find out more about 3Com Enterprise Management Suite, go to: www.3com.com/ems

Integration Kit with HP OpenView Network Node Manager

3Com Integration Kit for HP OpenView Network Node Manager offers businesses the option of managing their 3Com network directly from HP OpenView Network Node Manager. The kit includes Object IDs, icons, MIBs, and traps for 3Com devices. The package supports both Windows platforms and UNIX or Solaris platforms. It can be installed as a standalone plug-in to HP OpenView, or used with a 3Com management application such as 3Com Enterprise Management Suite (EMS).

To find out more about 3Com Integration Kit for HP OpenView Network Node Manager, go to: www.3com.com/hpovintkit

D

REDUNDANT POWER SUPPLY SAFETY INFORMATION

Important Safety Information



WARNING: This device has more than one power input. Disconnect all power inputs to power off this device.



WARNING: The installation of the Redundant Power Supply (RPS) should only be carried out by properly trained and qualified personnel.



WARNING: These instructions must be read in conjunction with the RPS flyer and the safety and installation instructions supplied with your RPS.



WARNING: When powering any Switch 4210 from an RPS, the unit must be earthed (grounded). This can be achieved by either connecting the power cord to the unit or by connecting the earth terminal on the rear of the unit to a reliable electrical earth, or by connecting both. It must be ensured that the earth connection is made before connecting the DC supply from the RPS.



WARNING: Any RPS must be approved as an unearthed SELV output in accordance with IEC 60950-1/UL 60950-1/EN 60950-1.



WARNING: RPS Manufacturers' recommendations must be followed when connecting the cable to the RPS.



WARNING: Ensure that the circuit breaker in the RPS is in the open (off) position when connecting the cable to the RPS.



WARNING: You must ensure that the positive terminal on the Switch is connected to the positive (common) terminal of the RPS and that the negative terminal on the Switch is connected to the negative (circuit breaker) terminal of the RPS.



WARNING: Ensure that the circuit breaker in the RPS is in the open (off) position when connecting the RPS cable and connector to the Switch.



WARNING: Do not use a standard 'positive-earthed' -48V redundant power system suitable for use with telecommunications equipment with the 3Com Power-over-Ethernet (PoE) network switches. In order to meet the IEEE 802.3af (PoE) specification, the -48V output must be isolated from earth (ground) and meet the isolation requirements in that specification.

L'information de Sécurité Importante



AVERTISSEMENT: Ce périphérique comporte plusieurs entrées d'alimentation. Déconnectez toutes les entrées d'alimentation afin de le mettre hors tension.



AVERTISSEMENT: L'installation du RPS (Redundant Power Supply) ne doit être confiée qu'à un personnel formé et qualifié.



AVERTISSEMENT: Ces instructions doivent être lues conjointement avec les instructions d'installation et les consignes de sécurité qui accompagnent le RPS.



AVERTISSEMENT: Lorsqu'un commutateur Switch 4210 est alimenté par un module RPS, l'unité doit être mise à la terre. Pour cela, branchez le cordon d'alimentation à l'unité ou branchez la borne de mise à la terre située à l'arrière de l'unité à une prise de terre fiable, ou procédez aux deux raccordements. Assurez-vous que l'unité est mise à la terre avant de raccorder l'alimentation CC du RPS.



AVERTISSEMENT: Le RPS doit être approuvé en tant que sortie SELV non reliée à la terre, conformément à la norme IEC 60950-1/UL 60950-1/EN 60950-1.



AVERTISSEMENT: Ces instructions doivent être lues conjointement avec les caractéristiques de l'alimentation CC du Switch 4210 fournies en annexe C, Spécifications techniques.



AVERTISSEMENT: Vous devez respecter les recommandations du fabricant lors du branchement du câble au module RPS.



AVERTISSEMENT: Assurez-vous que le disjoncteur du RPS est ouvert (off) lors du branchement du câble au RPS.



AVERTISSEMENT: Assurez-vous de brancher la borne positive du commutateur à la borne positive (commune) du RPS, et la borne négative du commutateur à la borne négative (disjoncteur) du RPS.



AVERTISSEMENT: Assurez-vous que le disjoncteur du RPS est ouvert (off) lors du branchement du câble et du connecteur du RPS au commutateur 3Com.



AVERTISSEMENT : N'utilisez pas de système standard d'alimentation redondante à 48 V relié à la terre convenant aux équipements de télécommunication avec les commutateurs réseau PoE (Power-Over-Ethernet) de 3Com. En vue de respecter la spécification IEEE 802.3af (PoE), la sortie 48 V doit être isolée de la terre (masse) et se conformer aux exigences d'isolation de cette spécification.

Wichtige Sicherheitsinformationen



VORSICHT: Dieses Gerät besitzt mehrere Eingänge zur Stromversorgung. Trennen Sie das Gerät zum Ausschalten von allen Stromquellen.



VORSICHT: Die RPS (Redundant Power Supply, redundante Stromversorgung) darf nur von entsprechend geschultem und qualifiziertem Fachpersonal installiert werden.



VORSICHT: Diese Anleitungen müssen im Zusammenhang mit den Sicherheitshinweisen und Installationsanleitungen zu Ihrer RPS gelesen werden.



VORSICHT: Bei der Stromversorgung eines Switch 4210 über eine RPS muss das Gerät geerdet sein. Hierfür kann entweder das Netzkabel an das Gerät angeschlossen werden oder die Erdungsklemme an der Rückseite des Geräts mit einer zuverlässigen elektrischen Erdung verbunden werden oder beides. Es ist sicherzustellen, dass die Erdungsverbindung vor dem Anschließen der von der RPS bereitgestellten Gleichstromversorgung hergestellt wird.



VORSICHT: Jede RPS muss als nicht geerdetes SELV-Ausgangsgerät gemäß IEC 60950-1/UL 60950-1/EN 60950-1 zugelassen sein.



VORSICHT: Diese Anleitungen müssen im Zusammenhang mit den Eigenschaften des Gleichstrom-Versorgungseingangs des Switch 4210 gelesen werden, die in Anhang C, "Technische Daten", aufgeführt sind.



VORSICHT: Beim Anschließen des Kabels an die RPS sind die Empfehlungen des Herstellers zu beachten.



VORSICHT: Stellen Sie sicher, dass sich der Schutzschalter an der RPS beim Anschließen des Kabels an die RPS in der geöffneten Stellung (Aus) befindet.



VORSICHT: Stellen Sie auf jeden Fall sicher, dass die positive Klemme am Switch an die positive (gemeinsame) Klemme der RPS und die negative Klemme am Switch an die negative (gemeinsame) Klemme der RPS angeschlossen wird.



VORSICHT: Stellen Sie sicher, dass sich der Schutzschalter an der RPS beim Anschließen des RPS-Kabels und des Steckers des 3Com Switch in der geöffneten Stellung (Aus) befindet.



VORSICHT: Verwenden Sie mit den 3Com PoE-Netzwerkswitches kein "positiv geerdetes" redundantes Standard-Netzsystem mit -48 Volt, wie es für Telekommunikationsgeräte geeignet ist. Um den IEEE 802.3af (PoE)-Spezifikationen zu entsprechen, muss der -48 Volt Ausgang erdfrei sein und die Isolierungsanforderungen dieser Spezifikation erfüllen.

Información de Seguridad Importante



ADVERTENCIA: Este dispositivo dispone de más de una entrada de alimentación. Desconecte todas las entradas de alimentación del dispositivo.



ADVERTENCIA: La instalación del sistema de alimentación superflua (RPS) sólo debería llevarla a cabo personal cualificado y con la debida formación.



ADVERTENCIA: Estas instrucciones deben leerse junto con las instrucciones de instalación y seguridad que se facilitan con el sistema RPS.



ADVERTENCIA: al encender cualquier Switch 4210 desde un RPS, la unidad debe contar con una toma de tierra (conexión a tierra). Esto se puede conseguir conectando el cable de alimentación de la unidad o bien conectando el terminal de tierra en la parte posterior de la unidad a una toma de tierra fiable, o

conectando ambas. Deberá asegurarse de que la conexión a tierra se realiza antes de conectar el suministro de CC del RPS.



ADVERTENCIA: Todos los RPS deben estar homologados como salidas SELV sin toma de tierra según IEC 60950-1/UL 60950-1/EN 60950-1.



ADVERTENCIA: Estas instrucciones deben leerse junto con las características de la entrada de suministro de CC del Switch 4210 del Apéndice C, Especificaciones técnicas.



ADVERTENCIA: al conectar el cable al RPS deberán seguirse las recomendaciones del fabricante.



ADVERTENCIA: asegúrese de que el disyuntor del RPS se encuentra en la posición de abierto (desactivado) al conectar el cable al RPS.



ADVERTENCIA: deberá asegurarse de que el terminal positivo del Switch está conectado al terminal positivo (común) del RPS, y de que el terminal negativo del Switch está conectado al terminal negativo (disyuntor) del RPS.



ADVERTENCIA: asegúrese de que el disyuntor del RPS se encuentra en la posición de abierto (desactivado) al conectar el cable del RPS y el conector al Switch 3Com.



ADVERTENCIA: No utilice un sistema de alimentación eléctrica redundante de -48 V con conexión a tierra positiva, adecuado para su uso con equipos de telecomunicaciones, con los conmutadores de red alimentados a través de Ethernet (PoE) de 3Com. Para cumplir con la especificación IEEE 802.3af (PoE), la salida de -48V debe estar aislada de la de tierra y cumplir con los requisitos de aislamiento de dicha especificación.

Importanti Informazioni di Sicurezza



AVVERTENZA: Il dispositivo presenta più punti di alimentazione. Per spegnere il dispositivo, scollegare tutti i punti di alimentazione.



AVVERTENZA: le operazioni di installazione dell'RPS (Redundant Power Supply) devono essere eseguite esclusivamente da personale qualificato e opportunamente addestrato.



AVVERTENZA: queste istruzioni devono essere lette insieme alle istruzioni di sicurezza e installazione fornite con l'RPS.



AVVERTENZA: se si accende uno Switch 4210 da un RPS, l'unità deve disporre di messa a terra. Per accendere lo switch, è possibile collegare il cavo di alimentazione all'unità, collegare il terminale di terra situato sul retro dell'unità a una presa elettrica di terra sicura oppure collegarli entrambi. Prima di collegare l'alimentazione CC dell'RPS, è necessario verificare la messa a terra.



AVVERTENZA: tutti gli RPS devono essere approvati come dispositivi di uscita SELV non messi a terra in conformità con le norme IEC 60950-1/UL 60950-1/EN 60950-1.



AVVERTENZA: queste istruzioni devono essere lette insieme ai valori di ingresso dell'alimentazione CC dello Switch 4210 che vengono forniti nell'Appendice C, Specifiche tecniche.



AVVERTENZA: quando si collega il cavo all'RPS, si consiglia di rispettare le raccomandazioni fornite dal fabbricante.



AVVERTENZA: durante il collegamento del cavo all'RPS, verificare che il salvavita dell'RPS si trovi in posizione Acceso (spento).



AVVERTENZA: è necessario verificare che il polo positivo sullo switch sia collegato al polo positivo (comune) dell'RPS e che il polo negativo sullo switch sia collegato al polo negativo (salvavita) dell'RPS.



AVVERTENZA: prima di collegare il cavo RPS e il connettore allo switch 3Com, verificare che il salvavita si trovi in posizione Acceso (spento).



AVVERTENZA: Non usare con gli switch di rete PoE (Power-over-Ethernet) di 3Com sistemi di alimentazione ridondante standard con 'messa a terra positiva' a -48 V normalmente usati con gli apparecchi di telecomunicazione. Per soddisfare lo standard IEEE 802.3af (PoE), l'uscita a -48V deve essere isolata da terra e soddisfare i requisiti d'isolamento per quello standard.

Ważne informacje o zabezpieczeniach



OSTRZEŻENIE: To urządzenie ma kilka punktów podłączenia zasilania. Aby wyłączyć urządzenie, należy odłączyć wszystkie punkty zasilania.



OSTRZEŻENIE: Instalacja zasilacza nadmiarowego (RPS) powinna być wykonywana przez odpowiednio przeszkolony i wykwalifikowany personel.



OSTRZEŻENIE: Te instrukcje należy przeczytać razem z instrukcjami dotyczącymi bezpieczeństwa i instalacji dostarczonymi z systemem zasilania nadmiarowego.



OSTRZEŻENIE: Jeśli dowolny przełącznik Switch 4210 jest zasilany z zasilacza RPS, urządzenie musi być uziemione. Można to uzyskać przez podłączenie przewodu zasilającego do urządzenia lub przez podłączenie końcówki uziemienia z tyłu urządzenia do dobrego elementu uziemiającego. Należy upewnić się, że urządzenie zostało uziemione przed podłączeniem zasilacza prądu stałego do zasilacza RPS.



OSTRZEŻENIE: Wszystkie zasilacze RPS muszą mieć certyfikat nieuziemionego źródła zasilania SELV zgodny z normami IEC 60950-1/UL 60950-1/EN 60950-1.



OSTRZEŻENIE: Te instrukcje należy przeczytać razem z charakterystyką zasilającego prądu stałego przełącznika Switch 4210 opisaną w Dodatku C, Specyfikacja techniczna.



OSTRZEŻENIE: Podczas podłączania kabla do zasilacza RPS należy przestrzegać zaleceń producenta.



OSTRZEŻENIE: Podczas podłączania kabla do zasilacza RPS należy upewnić się, że wyłącznik w zasilaczu jest w pozycji otwartej (wyłączony).



OSTRZEŻENIE: Należy upewnić się, że końcówka dodatnia przełącznika jest podłączona do dodatniej (wspólnej) końcówki zasilacza RPS, a ujemna końcówka przełącznika jest podłączona do ujemnej końcówki (wyłącznika) zasilacza RPS.



OSTRZEŻENIE: Nie używać standardowego „dodatnio uziemionego” -48-woltowego nadmiarowego systemu zasilania odpowiedniego przy użyciu ze sprzętem telekomunikacyjnym wraz z przełącznikami sieciowymi firmy 3Com w technologii Power-over-Ethernet (PoE). Aby spełnić wymagania specyfikacji IEEE 802.3af (PoE), -48-woltowy przewód wyjścia musi być odizolowany od ziemi (uziomu) i spełnić wymagania wykonania izolacji opisanymi w tej specyfikacji.

Regulatory Notices

FCC Statement

This equipment has been tested and found to comply with the limits for a Class A digital device, pursuant to part 15 of the FCC rules. These limits are designed to provide reasonable protection against harmful interference when the equipment is operated in a commercial environment. This equipment generates, uses and can radiate radio frequency energy and, if not installed and used in accordance with the instructions, may cause harmful interference to radio communications. Operation of this equipment in a residential area is likely to cause harmful interference to radio communications, in which case the user will be required to correct the interference at their own expense.

Information to the User

If this equipment does cause interference to radio or television reception, which can be determined by turning the equipment off and on, the user is encouraged to try to correct the interference by one or more of the following measures:

- Reorient the receiving antenna.
- Relocate the equipment with respect to the receiver.
- Move the equipment away from the receiver.
- Plug the equipment into a different outlet so that equipment and receiver are on different branch circuits.

How to identify and resolve radio-TV interference problems

This booklet is available from the U.S. Government Printing Office, Washington, DC 20402, Stock No. 004-000-00345-4.

In order to meet FCC emissions limits, this equipment must be used only with cables which comply with IEEE 802.3.

ICES Statement

This Class A digital apparatus complies with Canadian ICES-003.

Cet appareil numérique de la classe A respecte Class A est conforme a la norme NMB-003 du Canada.

CE Statements (Europe)

EU Representative:
3Com Europe Limited
Peoplebuilding 2, Peoplebuilding Estate
Maylands Avenue
Hemel Hempstead, Hertfordshire
HP2 4NW
United Kingdom

This product complies with the European Low Voltage Directive 73/23/EEC as amended by European Directive 93/68/EEC and EMC Directive 2004/108/EC.

Warning: This is a class A product. In a domestic environment this product may cause radio interference in which case the user may be required to take adequate measures.

A copy of the signed Declaration of Conformity can be downloaded from the Product Support web page for the Switch 4210 Product Family at <http://www.3com.com>.

Also available at http://support.3com.com/doc/Switch_4210_EU_DOC.pdf.

VCCI Statement

この装置は、情報処理装置等電波障害自主規制協議会（VCCI）の基準に基づくクラスA情報技術装置です。この装置を家庭環境で使用すると電波妨害を引き起こすことがあります。この場合には使用者が適切な対策を講ずるよう要求されることがあります。

