

# ArubaOS 8.0.1.0



User Guide

## **Copyright Information**

© Copyright 2017 Hewlett Packard Enterprise Development LP.

## **Open Source Code**

This product includes code licensed under the GNU General Public License, the GNU Lesser General Public License, and/or certain other open source licenses. A complete machine-readable copy of the source code corresponding to such code is available upon request. This offer is valid to anyone in receipt of this information and shall expire three years following the date of the final distribution of this product version by Hewlett Packard Enterprise Company. To obtain such source code, send a check or money order in the amount of US \$10.00 to:

Hewlett Packard Enterprise Company  
Attn: General Counsel  
3000 Hanover Street  
Palo Alto, CA 94304  
USA

---

<b>Contents</b> .....	<b>3</b>
Revision History .....	20
<b>About this Guide</b> .....	<b>21</b>
What's New In ArubaOS 8.0.1.0 .....	21
What's New In ArubaOS 8.0.0.0 .....	25
Fundamentals .....	33
System Requirements .....	34
Supported Browsers .....	35
Related Documents .....	35
Conventions .....	36
Contacting Support .....	37
<b>Mobility Master Configuration Hierarchy</b> .....	<b>38</b>
Enhancements .....	38
Configuration Hierarchy .....	39
Centralized Configuration .....	42
Configuration Validation .....	43
Configuration Distribution .....	44
ZTP and Branch Support .....	45
Redundancy .....	48
Serviceability .....	48
Auditing .....	50
Custom Certificates .....	51
User Interface .....	52
<b>Configuration User Interface</b> .....	<b>53</b>
Navigation Model .....	53

---

Menu .....	53
Profile Configuration Interface .....	54
Tables .....	54
Pending Changes .....	55
Help Mode .....	55
Hierarchy Management .....	56
<b>The Basic User-Centric Networks .....</b>	<b>57</b>
Understanding Basic Deployment and Configuration Tasks .....	57
Managed Devices Configuration Workflow .....	60
Connect the Managed Device to the Network .....	61
7200 Series Controllers Port Behavior .....	62
Using the LCD Screen .....	62
Configuring a VLAN to Connect to the Network .....	65
Enabling Wireless Connectivity .....	69
Configuring Your User-Centric Network .....	69
Replacing a Controller .....	69
<b>Control Plane Security .....</b>	<b>74</b>
Control Plane Security Overview .....	74
Configuring Control Plane Security .....	75
Managing AP Whitelists .....	76
Whitelist DB Optimization .....	82
Configuring Networks with a Backup Mobility Master .....	83
Replacing a Controller on a Multi-Controller Network .....	83
Troubleshooting Control Plane Security .....	84
<b>Network Configuration Parameters .....</b>	<b>86</b>
Getting Started with ArubaOS WLANs .....	86
Campus WLAN Workflow .....	86
Understanding VLAN Assignments .....	88

---

Configuring VLANs .....	89
Trusted Vs. Untrusted Ports and VLANs .....	96
Assign an IP Address to a VLAN .....	97
Configuring Trusted/Untrusted Ports and VLANs .....	100
Configuring the Mobility Master IP Address .....	102
Configuring the Loopback IP Address .....	102
Configuring Static IP Routes .....	103
Configuring GRE Tunnels .....	104
GRE Tunnel Groups .....	110
Jumbo Frame Support .....	112
PVST+ (Per-VLAN Spanning Tree Plus) .....	113
Rapid Spanning Tree Protocol (RSTP) .....	114
Configuring RSTP .....	115
PortFast and BPDU Guard for Spanning Tree .....	116
Link Layer Discovery Protocol .....	118
<b>IPv6 Support .....</b>	<b>122</b>
Understanding IPv6 Notation .....	122
Enabling IPv6 .....	122
Enabling IPv6 Support for Mobility Master and APs .....	123
Filtering an IPv6 Extension Header .....	131
Configuring a Captive Portal over IPv6 .....	132
Working with IPv6 Router Advertisements .....	132
IPsec Support .....	135
RADIUS Over IPv6 .....	145
TACACS Over IPv6 .....	146
DHCPv6 Server .....	147
Understanding ArubaOS Supported Network Configuration for IPv6 Clients .....	150
Understanding ArubaOS Authentication and Firewall Features that Support IPv6 .....	151

---

Understanding IPv6 Exceptions and Best Practices .....	157
<b>Port Channel Link Aggregation Control Protocol .....</b>	<b>158</b>
LACP Best Practices and Exceptions .....	158
Configuring LACP .....	159
<b>OSPFv2 .....</b>	<b>161</b>
Understanding OSPF Deployment Best Practices and Exceptions .....	161
Understanding OSPFv2 by Example using a WLAN Scenario .....	162
Understanding OSPFv2 by Example using a Branch Scenario .....	163
Configuring OSPF .....	165
Sample Topology and Configuration .....	166
<b>Tunneled Nodes .....</b>	<b>177</b>
Understanding Tunneled Node Configuration .....	177
Configuring a Wired Tunneled Node Client .....	178
<b>Authentication Servers .....</b>	<b>180</b>
Understanding Authentication Server Best Practices and Exceptions .....	180
Understanding Servers and Server Groups .....	180
Configuring Authentication Servers .....	181
Managing the Internal Database .....	190
Configuring Server Groups .....	191
Assigning Server Groups .....	197
Configuring Authentication Timers .....	201
Authentication Server Load Balancing .....	203
<b>MAC-Based Authentication .....</b>	<b>204</b>
Configuring MAC-Based Authentication .....	204
Configuring Clients .....	206
<b>Managed Devices at Branch Offices .....</b>	<b>207</b>
Provision and Configure Managed Devices .....	207
Managed Device Feature Overview .....	207

---

Scalable Site-to-Site VPN Tunnels .....	208
WAN Health Check .....	209
Zero-Touch Provisioning Overview .....	209
WAN Authentication Survivability Overview .....	211
Using ZTP to Provision a Managed Device .....	216
Health Check Services for Managed Devices .....	220
WAN Optimization through IP Payload Compression .....	221
WAN Interface Bandwidth Priorities .....	222
Uplink Monitoring and Load Balancing .....	223
Policy Based Routing .....	226
Uplink Routing using Nexthop Lists .....	227
Address Pool Management .....	229
Configuring WAN Authentication Survivability .....	232
Preventing WAN Link Failure on Virtual APs .....	233
<b>802.1X Authentication .....</b>	<b>235</b>
Understanding 802.1X Authentication .....	235
Configuring 802.1X Authentication .....	238
Enabling 802.1X Supplicant Support on an AP .....	247
Sample Configurations .....	248
Performing Advanced Configuration Options for 802.1X .....	266
Application Single Sign-On Using L2 Authentication .....	267
Device Name as User Name for Non-802.1X Authentication .....	269
<b>Stateful and WISPr Authentication .....</b>	<b>271</b>
Working With Stateful Authentication .....	271
Working With WISPr Authentication .....	272
Understanding Stateful Authentication Best Practices .....	272
Configuring Stateful 802.1X Authentication .....	272
Configuring Stateful NTLM Authentication .....	274

---

Configuring Stateful Kerberos Authentication .....	275
Configuring WISPr Authentication .....	276
<b>Certificate Revocation .....</b>	<b>279</b>
Understanding OCSP and CRL .....	279
Configuring the Mobility Master or Managed Device as an OCSP Client .....	280
Configuring the Mobility Master or Managed Device as a CRL Client .....	281
Configuring the Mobility Master or Managed Device as an OCSP Responder .....	282
Certificate Revocation Checking for SSH Pubkey Authentication .....	283
<b>Captive Portal Authentication .....</b>	<b>286</b>
Captive Portal Deployment Models .....	286
Understanding Captive Portal .....	287
Configuring Captive Portal in the Base Operating System .....	288
Using Captive Portal with a PEFNG License .....	290
Sample Authentication with Captive Portal .....	292
Configuring Guest VLANs .....	300
Configuring Captive Portal Authentication Profiles .....	301
Enabling Optional Captive Portal Configuration .....	306
Personalizing the Captive Portal Page .....	310
Creating Walled Garden Access .....	313
Enabling Captive Portal Enhancements .....	314
<b>Controller Clustering .....</b>	<b>319</b>
Supported Platform .....	319
Support for Heterogeneous Cluster .....	320
RAP and IPv6 Support .....	320
Cluster Load Balancing .....	320
Enhanced Multicast Proxy .....	321
Session State Synchronization .....	321
Authorization Server Interaction .....	322



---

AP Fail Over to Different Cluster .....	322
AP-Move .....	322
Cluster Configuration .....	323
<b>Cluster Deployment Scenarios .....</b>	<b>327</b>
Troubleshooting Cluster .....	330
<b>MultiZone .....</b>	<b>335</b>
Configuration .....	336
<b>Virtual Private Networks .....</b>	<b>338</b>
Planning a VPN Configuration .....	338
Working with VPN Authentication Profiles .....	342
Configuring a Basic VPN for L2TP/IPsec .....	344
Configuring a VPN for L2TP/IPsec with IKEv2 .....	349
Configuring a VPN for Smart Card Clients .....	354
Configuring a VPN for Clients with User Passwords .....	355
Configuring Remote Access VPNs for XAuth .....	356
Working with Remote Access VPNs for PPTP .....	358
Working with Site-to-Site VPNs .....	358
Working with VPN Dialer .....	365
<b>Roles and Policies .....</b>	<b>367</b>
Configuring Firewall Policies .....	367
User Roles .....	376
Assigning User Roles .....	378
Understanding Global Firewall Parameters .....	383
AppRF 2.0 .....	389
<b>ClearPass Policy Manager Integration .....</b>	<b>398</b>
Introduction .....	398
Important Points to Remember .....	398
Enabling Downloadable Role on a Managed Device .....	399

---

Sample Configuration .....	399
<b>Configuring WLANs .....</b>	<b>404</b>
Basic WLAN Configuration Workflow .....	404
WLAN Configuration Profiles .....	410
Configuring the Virtual AP Profile .....	412
Radio Resource (802.11k) and BSS Transition Management (802.11v) .....	420
Fast BSS Transition ( 802.11r) .....	428
WLAN SSID Profiles .....	429
WLAN Authentication .....	436
<b>RF Planning and Channel Management .....</b>	<b>439</b>
AirMatch RF Management Overview .....	439
ClientMatch Overview .....	441
Configuring AirMatch .....	444
Configuring ClientMatch .....	445
RF Management for Stand-alone Controller Deployments .....	446
ARM Coverage and Interference Metrics .....	452
Configuring ARM Profiles .....	453
Dynamic Bandwidth Switch .....	459
Troubleshooting ARM .....	459
<b>Wireless Intrusion Prevention .....</b>	<b>461</b>
Working with the Reusable Wizard .....	461
Monitoring the Security Dashboard .....	462
Detecting Rogue APs .....	463
Working with Intrusion Detection .....	466
Configuring Intrusion Protection .....	478
Configuring the WLAN Management System (WMS) .....	481
Understanding Client Blacklisting .....	487
Working with WIP Advanced Features .....	490

---

Configuring TotalWatch .....	490
Administering TotalWatch .....	493
Tarpit Shielding Overview .....	494
Configuring Tarpit Shielding .....	494
<b>Access Points .....</b>	<b>496</b>
Basic Functions and Features .....	496
AP Settings Triggering a Radio Restart .....	497
Naming and Grouping APs .....	499
Understanding AP Configuration Profiles .....	502
Before you Deploy an AP .....	504
Enable Controller Discovery .....	504
Enable DHCP to Provide APs with IP Addresses .....	506
AP Provisioning .....	507
Configuring Installed APs .....	509
Configuring AP Image Preload .....	514
Optional AP Configuration Settings .....	516
2.4 Ghz and 5 Ghz Radio RF Management .....	530
High-Throughput APs .....	536
Validating and Optimizing AP Connectivity .....	542
AP Chanel Scanning .....	543
Channel Group Scanning .....	545
Managing AP Console Settings .....	545
Link Aggregation Support .....	549
Support for Port Bounce .....	552
<b>Secure Enterprise Mesh .....</b>	<b>553</b>
Mesh Overview Information .....	553
Mesh Configuration Procedures .....	553
Understanding Mesh Access Points .....	553

---

Understanding Mesh Links .....	555
Understanding Mesh Profiles .....	557
Understanding Remote Mesh Portals (RMPs) .....	561
Understanding the AP Boot Sequence .....	562
Mesh Deployment Solutions .....	563
Mesh Deployment Planning .....	565
Configuring Mesh Cluster Profiles .....	567
Creating and Editing Mesh Radio Profiles .....	571
Creating and Editing Mesh High-Throughput SSID Profiles .....	576
Configuring Ethernet Ports for Mesh .....	582
Provisioning Mesh Nodes .....	585
Verifying Your Mesh Network .....	586
Configuring Remote Mesh Portals (RMPs) .....	588
<b>Increasing Network Uptime Through Redundancy and VRRP .....</b>	<b>590</b>
Getting Started with High Availability and VRRP Solutions .....	590
High Availability Overview .....	590
High Availability with Extended Capacity .....	593
Client State Synchronization .....	594
High Availability Inter-Controller Heartbeats .....	595
Configuring High Availability .....	595
VRRP Redundancy for Multi-Master Topologies .....	597
Migrating from VRRP or Backup-LMS Redundancy .....	602
<b>IP Mobility .....</b>	<b>603</b>
Understanding Aruba Mobility Architecture .....	603
Configuring Mobility Domains .....	604
Tracking Mobile Users .....	606
Configuring Advanced Mobility Functions .....	608
Understanding Bridge Mode Mobility Deployments .....	617

---

Monitoring Network Traffic Using IPFIX .....	618
Enabling Mobility Multicast .....	621
<b>External Firewall Configuration .....</b>	<b>626</b>
Understanding Firewall Port Configuration Among Aruba Devices .....	626
Enabling Network Access .....	627
Ports Used for Virtual Intranet Access (VIA) .....	627
Configuring Ports to Allow Other Traffic Types .....	627
<b>Enhanced Security .....</b>	<b>629</b>
Interoperability .....	629
Configuring PAPI Enhanced Security .....	629
Verifying PAPI Enhanced Security .....	630
<b>Palo Alto Networks Firewall Integration .....</b>	<b>632</b>
Limitations .....	632
Preconfiguration on the PAN Firewall .....	632
Configuring PAN Firewall Integration .....	635
<b>Remote Access Points .....</b>	<b>639</b>
About Remote Access Points .....	639
Configuring the Secure Remote Access Point Service .....	640
Deploying a Branch/Home Office Solution .....	646
Enabling Remote AP Advanced Configuration Options .....	652
Understanding Split Tunneling .....	667
Understanding Bridge .....	673
Provisioning Wi-Fi Multimedia .....	678
Reserving Uplink Bandwidth .....	678
Provisioning 4G USB Modems on Remote Access Points .....	679
Configuring RAP-3WN and RAP-3WNP Access Points .....	681
Converting an IAP to RAP or CAP .....	681
Enabling Bandwidth Contract Support for RAPs .....	682

---

<b>Virtual Intranet Access</b> .....	<b>686</b>
<b>Spectrum Analysis</b> .....	<b>688</b>
Understanding Spectrum Analysis .....	688
Creating Spectrum Monitors and Hybrid APs .....	693
Connecting Spectrum Devices to Spectrum Analysis Client .....	695
Configuring Spectrum Analysis Dashboards .....	697
Customizing Spectrum Analysis Graphs .....	699
Working with Non-Wi-Fi Interferers .....	713
Understanding Spectrum Analysis Session Log .....	714
Viewing Spectrum Analysis Data .....	714
Recording Spectrum Analysis Data .....	715
Troubleshooting Spectrum Analysis .....	717
<b>Dashboard Monitoring</b> .....	<b>719</b>
Dashboard in Mobility Master Mode .....	719
Dashboard in Master Controller Mode .....	719
Dashboard Pages .....	719
WAN .....	720
Performance .....	721
Network .....	723
Cluster .....	724
Usage .....	726
Potential Issues .....	727
Traffic Analysis .....	728
AirGroup .....	740
Security .....	745
UCC .....	746
Controller .....	749
WLANs .....	750

---

Access Points .....	751
Clients .....	752
<b>Automatic Reporting (PhoneHome) .....</b>	<b>754</b>
Pre-Deployment Information .....	754
Configuration Procedures .....	754
Registering with Activate .....	754
Configuring PhoneHome Automatic Reporting .....	755
Sending Reports to Activate vs. SMTP Servers .....	756
Sending an Individual Report .....	757
Viewing Report Status .....	757
PhoneHome-Lite .....	758
<b>Management Access .....</b>	<b>760</b>
Configuring Certificate Authentication for WebUI Access .....	760
Secure Shell (SSH) .....	761
Enabling RADIUS Server Authentication .....	763
Connecting to AirWave Server .....	768
Custom Certificate Support for RAP .....	770
Implementing Specific Management Password Policy .....	772
Configuring Centralized Image Upgrades .....	774
Managing Certificates .....	776
Configuring SNMP .....	782
Enabling Capacity Alerts .....	784
Configuring Logging .....	786
Enabling Guest Provisioning .....	788
Managing Files on Managed Device .....	804
Setting System Clock .....	807
ClearPass Policy Manager Profiling with IF-MAP .....	809
Whitelist Synchronization .....	810

---

Downloadable Regulatory Table .....	811
<b>Hotspot 2.0 .....</b>	<b>814</b>
Hotspot 2.0 Pre-Deployment Information .....	814
Hotspot Profile Configuration Tasks .....	814
Hotspot 2.0 Overview .....	814
Configuring Hotspot 2.0 Profiles .....	817
Configuring Hotspot Advertisement Profiles .....	822
Configuring ANQP Venue Name Profiles .....	824
Configuring ANQP Network Authentication Profiles .....	826
Configuring ANQP Domain Name Profiles .....	827
Configuring ANQP IP Address Availability Profiles .....	828
Configuring ANQP NAI Realm Profiles .....	829
Configuring ANQP Roaming Consortium Profiles .....	833
Configuring ANQP 3GPP Cellular Network Profiles .....	834
Configuring H2QP Connection Capability Profiles .....	835
Configuring H2QP Operator Friendly Name Profiles .....	837
Configuring H2QP Operating Class Indication Profiles .....	838
Configuring H2QP WAN Metrics Profiles .....	838
<b>SDN Controller .....</b>	<b>841</b>
Southbound Interface .....	841
SDN Controller Configuration on Mobility Master .....	842
SDN Platform Services .....	842
Northbound API .....	852
<b>OpenFlow Agent .....</b>	<b>866</b>
Enabling SDN Controller on Mobility Master .....	866
Configuring OpenFlow Agent on Managed devices .....	867
Viewing OpenFlow Information .....	869



---

<b>Loadable Service Module</b> .....	<b>870</b>
Service Modules .....	870
Service Packages .....	870
Upgrading a Service Module .....	870
Troubleshooting .....	872
<b>Voice and Video</b> .....	<b>874</b>
Voice and Video License Requirements .....	874
Configuring Voice and Video .....	874
Working with QoS for Voice and Video .....	884
Unified Communication and Collaboration .....	890
Understanding Extended Voice and Video Features .....	931
<b>AirGroup</b> .....	<b>939</b>
Zero Configuration Networking .....	939
AirGroup Solution .....	940
AirGroup in ArubaOS 8.0 .....	940
AirGroup Value Additions in Mobility Master .....	941
AirGroup Services .....	941
AirGroup Deployment Models .....	942
AirGroup Changes from ArubaOS 6.x .....	942
AirGroup Features Deprecated in ArubaOS 8.0 .....	943
AirGroup Features .....	943
Prerequisites to Enable AirGroup .....	950
Configuring AirGroup .....	954
Best Practices and Limitations .....	985
Troubleshooting and Log Messages .....	987
<b>Instant AP VPN Support</b> .....	<b>990</b>
Overview .....	990
VPN Configuration .....	994

---

Viewing Branch Status .....	996
<b>External Services Interface .....</b>	<b>998</b>
Sample ESI Topology .....	998
Understanding the ESI Syslog Parser .....	1000
Configuring ESI .....	1003
Sample Route-Mode ESI Topology .....	1010
Sample NAT-mode ESI Topology .....	1016
Understanding Basic Regular Expression (BRE) Syntax .....	1021
<b>External User Management .....</b>	<b>1024</b>
Overview .....	1024
How the ArubaOS XML API Works .....	1024
Creating an XML Request .....	1024
XML Response .....	1027
Using the XML API Server .....	1031
Sample Scripts .....	1037
<b>Behavior and Defaults .....</b>	<b>1044</b>
Understanding Mode Support .....	1044
Understanding Basic System Defaults .....	1046
Understanding Default Management User Roles .....	1054
Understanding Default Open Ports .....	1055
<b>DHCP with Vendor-Specific Options .....</b>	<b>1059</b>
Configuring a Windows-Based DHCP Server .....	1059
Enabling DHCP Relay Agent Information Option (Option 82) .....	1060
Enabling Linux DHCP Servers .....	1061
<b>802.1X Configuration for IAS and Windows Clients .....</b>	<b>1062</b>
Configuring Microsoft IAS .....	1062
Configuring Management Authentication Using IAS .....	1064
Window XP Wireless Client Sample Configuration .....	1066

---

<b>Acronyms and Terms</b> .....	<b>1069</b>
Acronyms .....	1069
Terms .....	1076

## Revision History

The following table lists the revisions of this document.

**Table 1:** *Revision History*

Revision	Change Description
Revision 03	<ul style="list-style-type: none"><li>Added SNMP support for LLDP MIBs in <a href="#">Link Layer Discovery Protocol</a> section.</li><li>Added the <a href="#">Cluster Deployment Scenarios</a> section.</li></ul>
Revision 02	Added the <a href="#">System Requirements</a> section.
Revision 01	Initial release.

This User Guide describes the features supported in ArubaOS 8.0 and provides instructions and examples to configure Mobility Master, managed devices, and access points (APs). This guide is intended for system administrators responsible for configuring and maintaining wireless networks and assumes administrator knowledge in Layer 2 and Layer 3 networking technologies.



---

Throughout this document, branch controller and local controller are termed as a managed device.

---

This chapter covers the following topics:

- [What's New In ArubaOS 8.0.1.0 on page 21](#)
- [What's New In ArubaOS 8.0.0.0 on page 25](#)
- [Fundamentals on page 33](#)
- [System Requirements on page 34](#)
- [Supported Browsers on page 35](#)
- [Related Documents on page 35](#)
- [Conventions on page 36](#)
- [Contacting Support on page 37](#)

## What's New In ArubaOS 8.0.1.0

This section lists the new features, enhancements, and hardware platforms introduced in ArubaOS 8.0.1.0.

### 7200 Series Master Controller Mode

ArubaOS 8.0.1.0 supports 7200 Series controllers to run as a master controller. In this mode, you can retain the existing ArubaOS 6.x master-local architecture and migrate to ArubaOS 8.x. Services like AirGroup, AppRF, ARM, NBAPI, UCM, WebCC, and WMS will remain distributed across managed devices. All features in ArubaOS 6.5.x and ArubaOS 8.x are supported in this mode, except the following:

- AP termination on the master controller
- Loadable Service Module
- AirMatch
- Cluster
- North-bound API
- Multi-version ArubaOS support
- Centralized visibility
- IP reputation and geo-location
- Centralized licensing domain
- Seamless logon

To gain access to these features, replace the master controller with Mobility Master. To migrate from ArubaOS 6.x to ArubaOS 8.x, see the *ArubaOS 8.x Migration Guide*.

## New Features

**Table 2:** *New Features in ArubaOS 8.0.1.0*

New Features	Description
Support for Kernel-based Virtual Machine	ArubaOS 8.0.1.0 introduces support for Kernel-based Virtual Machine (KVM). For more information, refer to the <i>Aruba Mobility Master and VMC Installation Guide</i> .
Support for interactive tool for migrating ArubaOS 6.x deployments to ArubaOS 8.x	<p>Mobility Master provides an interactive migration tool to migrate the ArubaOS 6.x controllers deployed in various scenarios to a managed device under Mobility Master. The supported deployment scenarios are as follows:</p> <ul style="list-style-type: none"> <li>• Migrating Master-Local setup to Mobility Master</li> <li>• Migrating All-Master setup to Mobility Master</li> <li>• Migrating Master-Local setup to Master Controller Mode in ArubaOS 8.x</li> <li>• Migrating to a stand-alone controller running ArubaOS 8.x</li> </ul> <p>For more information, refer to the <i>ArubaOS 8.x Migration Guide</i>.</p>
<a href="#">Improved AirMatch Channel Assignment Logic</a>	<p>In previous versions of ArubaOS, AirMatch moved a radio to a random channel when a radar event was detected, or if a high noise floor was detected on a non-static channel.</p> <p>Starting with ArubaOS 8.0.1.0, AirMatch introduces improved channel assignment logic if a radar or high noise level event triggers a channel change.</p>
<a href="#">PAPI Enhanced Security</a>	The PAPI Enhanced Security configuration provides protection to Aruba devices, Mobility Access Switches, HPE-ArubaOS Switch-based switches, Mobility Master, managed devices, AirWave, and ALE against malicious users sending fake messages that results in security challenges.
<a href="#">Quality Improvement Thresholds for AirMatch Scheduled Updates</a>	ArubaOS 8.0.1.0 introduces the AirMatch channel quality improvement threshold, which allows you to select the minimum channel improvement that can trigger a new scheduled channel solution. The default threshold value is a 15% improvement. If a proposed channel change will not produce an improvement that meets or exceeds this threshold, AirMatch will not trigger a channel change.
<a href="#">Support for VIA-Published Subnets</a>	This new feature, when enabled, allows Mobility Master and managed devices to accept the subnets published by VIAclients. This feature is disabled by default.
Support for Microsoft Edge browser	The ArubaOS WebUI now supports Microsoft Edge (Microsoft Edge 38.14393.0.0 and Microsoft EdgeHTML 14.14393) on Windows 10.

**Table 3: Enhancements in ArubaOS 8.0.1.0**

Enhancements	Description
<a href="#">AirGroup Deployment Model</a>	ArubaOS 8.0.1.0 supports 7200 Series controllers to run as a master controller. AirGroup is supported in master controller mode.
<a href="#">Bulk Edit</a>	Starting from ArubaOS 8.0.1.0, the <b>Bulk Configuration Status</b> pop up displays the status of the configurations applied.
Change Configuration Node using Hostname of Managed Device	Starting from ArubaOS 8.0.1.0, a user can change the configuration node by using the hostname of the managed device.
<a href="#">Personalizing Captive Portal</a>	The WebUI for personalizing the captive portal page is enhanced where the user can now select custom login or welcome page, background images, logos, Acceptable Use Policy (AUP) texts, and so on with responsive design. Also, starting from ArubaOS 8.0.1.0, the AUP text is displayed only if the AUP text was previously entered.
<a href="#">Dashboard in Master Mode</a>	ArubaOS 8.0.1.0 supports 7200 Series controllers to run as a master controller. Dashboard is supported in master controller mode.
<a href="#">Device Type Classification</a>	Starting from ArubaOS 8.0.1.0, the device type classification is enhanced to identify the device type for each client, determine firewall policies, and customize to meet the requirement of the end user. The device type information is sent from ClearPass to ArubaOS.
<a href="#">IPFIX Enhancements</a>	Starting from ArubaOS 8.0.1.0, IPFIX supports wireless export. When wireless export is enabled, a new template is defined to gather and export information about wireless clients, in addition to the standard attributes exported through the existing, pre-defined template.
<a href="#">Modifying Profile Parameters Associated with WLANs</a> <a href="#">Modifying Profiles and Parameters Associated with AP Groups</a>	Starting from ArubaOS 8.0.1.0, users can modify profiles and parameters associated with AP Groups. You can also modify the parameters of profiles that are associated to a WLAN when it was created.
<a href="#">Radio Mode</a>	Starting from ArubaOS 8.0.1.0, the configuration of AP Group <b>Radio Mode</b> parameters depends on the <b>Radio Mode</b> selected.
Seamless Login to Managed Device	Starting from ArubaOS 8.0.1.0, a user can log in to a managed device without requiring username and password after logging in to the Mobility Master.
<a href="#">UCC in Master Controller Mode</a>	ArubaOS 8.0.1.0 supports 7200 Series controllers to run as a master controller. UCC is supported in master controller mode.

**Table 4:** *New Hardware Platforms in ArubaOS 8.0.1.0*



Check with your local Aruba sales representative on new managed devices and access points availability in your country.

Hardware	Description
310 Series	<p>The 310 Series (AP-314 and AP-315) wireless access points support IEEE 802.11ac standards for a high-performance WLAN. This device is equipped with two single-band radios that provide network access and monitor the network simultaneously. 310 Series access points deliver high-performance 802.11n 2.4 GHz and 802.11ac 5 GHz functionality, while also supporting 802.11a/b/g wireless services. Multi-User Multiple-Input Multiple-Output (MU-MIMO) is enabled when operating in 5GHz mode for optimal performance. The 310 Series wireless access points work in conjunction with a managed device.</p> <p>The 310 Series wireless access points provides the following capabilities:</p> <ul style="list-style-type: none"><li>• IEEE 802.11a/b/g/n/ac wireless access point</li><li>• IEEE 802.11a/b/g/n/ac wireless air monitor</li><li>• IEEE 802.11a/b/g/n/ac spectrum monitor</li><li>• Compatible with IEEE 802.3at and 802.3af PoE</li><li>• Support for MCS8 and MCS9</li><li>• Centralized management, configuration, and upgrades</li><li>• Integrated Bluetooth Low Energy (BLE) radio</li></ul> <p>For more information, see the <i>310 Series Wireless Access Point Installation Guide</i>.</p>
330 Series	<p>The 330 Series (AP-334 and AP-335) wireless access points support IEEE 802.11ac standards for high-performance WLAN. This device is equipped with two dual-band radios, which provide network access and monitor the network simultaneously. This access point delivers high-performance 802.11n 2.4 GHz and 802.11ac 5 GHz functionality, while also supporting 802.11a/b/g wireless services. Multi-User Multiple-Input Multiple-Output (MU-MIMO) is enabled when operating in 5 GHz mode for optimal performance. The 330 Series wireless access points work in conjunction with a managed device.</p> <p>The 330 Series wireless access points provides the following capabilities:</p> <ul style="list-style-type: none"><li>• IEEE 802.11a/b/g/n/ac wireless access point</li><li>• IEEE 802.11a/b/g/n/ac wireless air monitor</li><li>• IEEE 802.11a/b/g/n/ac spectrum monitor</li><li>• Compatible with IEEE 802.3at power sources</li><li>• Centralized management, configuration, and upgrades</li><li>• Integrated Bluetooth Low Energy (BLE) radio</li></ul> <p>For more information, see the <i>330 Series Wireless Access Point Installation Guide</i>.</p>



## What's New In ArubaOS 8.0.0.0

This section lists the new features, enhancements, and hardware platforms introduced in ArubaOS 8.0.0.0.

### Mobility Master Architecture

ArubaOS 8.0 is a brand new centralized, multi-tier architecture that provides a clear separation between management, control, and forwarding functions. Mobility Master takes the place of a master controller in the network hierarchy. A single Mobility Master or a cluster of Mobility Masters oversee controllers that are co-located (on-premise local controllers or off-campus branch office local controllers). Each Mobility Master cluster is referred to as a Mobility Master domain. All the controllers that connect to Mobility Master act as managed devices. In a large campus, there may be multiple Mobility Master domains.

The entire configuration for both the Mobility Master and managed devices is set up from a centralized point, thereby simplifying and streamlining the configuration process. Mobility Master consolidates all-master, single master-multiple local, and multiple master-local deployments into a single deployment model. In contrast, the ArubaOS 6.x and earlier release trains run on a flat configuration model containing global and local configurations. Global configurations are applied to the master controller and can only be propagated to each local controller through the master. The respective local configurations are applied directly to each master or local controller.

The goal of Mobility Master is to develop a platform that achieves the following:

- Reduces complexity of configuring and managing WLAN deployments.
- Hosts services that run with a central view of the network.
- Assimilates and provides access to the context and data available in the network infrastructure.
- Provides rich APIs that create an ecosystem to build custom applications (in-house/custom/third party), connecting the application intelligence with network intelligence.
- Is highly available and can scale elastically using VM and clustering techniques.

### Limitations

ArubaOS 8.0 includes the following limitations:

- Mobility Master supports only VMware ESXi Hypervisor.
- Certain VMware features, such as vMotion and DRS, are not supported.
- CPU oversubscription is not supported.
- A maximum of four network adapters are supported.
- Promiscuous mode must be enabled on the vSwitch to avoid address resolution protocol (ARP) issues.

## New Features

**Table 5:** *New Features in ArubaOS 8.0*

New Features	Description
<a href="#">AirGroup Dashboard</a>	<p>The <b>AirGroup</b> dashboard provides enhanced visibility into AirGroup, displaying the following information:</p> <ul style="list-style-type: none"> <li>• Traffic trends</li> <li>• Server distribution</li> <li>• Server and user bandwidth</li> </ul> <p><b>NOTE:</b> The combined view of all AirGroup devices and usage in the network is available under the <b>AirGroup</b> dashboard of every node in the hierarchy, regardless of deployment type.</p>
<a href="#">AirGroup Features</a>	<p>AirGroup allows the ability to define the number of hops, use named VLANs, scale, and a quickaccess mobile phone application to register for AirGroup services.</p>
<a href="#">AirMatch RF Management</a>	<p>AirMatch optimizes RF network resource allocation by analyzing the past 24 hours of RF network statistics, and proactively optimizing the network for the next day. AirMatch can also react to detrimental RF events such as radar and high noise levels, to allow the network to manage sudden changes in the RF environment.</p> <p>The AirMatch channel and EIRP optimization features deprecate the channel planning and EIRP optimization features in the legacy Adaptive Radio Management (ARM) feature. AirMatch is supported only on Mobility Master, while legacy ARM channel optimization and EIRP features continue to be supported by stand-alone controllers running ArubaOS 8.0.</p>
<a href="#">AP Health Checks</a>	<p>The AP Health check feature uses ping probes to check reachability and latency levels for the connection between the AP and the managed device. The recorded latency information appears in the output of the <b>show ap ip health-check</b> command. If the managed device IP address becomes unreachable from the AP uplink, this feature records the time that the connection failed, and saves that information in a log file (tmp/ap_hcm_log) on the AP.</p>
<a href="#">AP Termination on Mobility Master</a>	<p>Mobility Master cannot be used as an AP Master since APs are not allowed to terminate on a Mobility Master. If the AP manager on a Mobility Master receives an <b>AP HELLO</b> message, the message is dropped.</p>
<a href="#">AppRF Features</a>	<p>AppRF 2.0 provides the ability to support Protocol Data Definition (PDD) based application signatures and define custom applications.</p>
<p>Centralized Licensing</p>	<p>ArubaOS 8.0 introduces several changes to centralized licensing. ArubaOS supports new license types used to install Mobility Master on a VM, install a managed device on a VM, or apply firewall policies to clients using a VPN to connect to the VM. The xSec license is deprecated in ArubaOS 8.0, as it supports xSec features in the base operating system, without any additional license requirements.</p> <p>Starting in ArubaOS 8.0, you add licenses to a managed device by adding the license to Mobility Master, and then associating that license to either a specific managed device, or a shared pool of licenses. Licenses cannot be added directly to a managed device. You must enable support for sharable licenses by enabling each licensing feature type on Mobility Master.</p> <p><b>NOTE:</b> For more information, refer to the <i>Aruba Mobility Master Licensing Guide</i>.</p>

New Features	Description
<a href="#">Cluster</a>	<p>Clustering is based on keeping client processing, that is, signaling and traffic, anchored to a managed device regardless of which AP the client roams to, as long as the AP is within the control scope of the cluster. Since, the client is fixed at a given managed device, a single Basic Service Set (BSS) on an AP can now have clients that are anchored at multiple managed devices.</p> <ul style="list-style-type: none"> <li>• The cluster size can reach up to 12 managed devices to support very large campus deployments. It supports 7200 Series, 7000 Series, and VM platform. Cluster supports all the cluster-related GSM channels on 7000 Series and VM platforms. Cluster setup supports RAPS and IPv6 clients.</li> <li>• The client load is shared by all the managed devices and there is a larger roaming domain with smaller fault domain which helps with faster recovery.</li> <li>• Enhanced Multicast Proxy feature is an integral part of the cluster setup.</li> <li>• Session State Synchronization feature resolves all issues regarding seamless roaming, service availability, and high availability.</li> <li>• Cluster supports redundancy for both APs and clients.</li> <li>• An AP is able to failover between clusters.</li> <li>• <b>AP-Move</b> feature enables a user to move a specific AP to the target managed device from a specific managed device.</li> </ul>
<a href="#">Cluster Dashboard</a>	<p>The <b>Cluster</b> dashboard provides a visual overview of each cluster deployed on the network, displaying the following information:</p> <ul style="list-style-type: none"> <li>• Health information between cluster members</li> <li>• Total AP load per Cluster (AAC)</li> <li>• Total User load per Cluster (UAC)</li> <li>• Connection time</li> </ul> <p><b>NOTE:</b> The <b>Cluster</b> dashboard can only be accessed from the root (Managed Network) node of the Mobility Master hierarchy. This information is not displayed on any stand-alone controllers, managed devices, or other nodes in the hierarchy.</p>
<a href="#">Configuration Auto-Rollback</a>	<p>Mobility Master supports an auto-rollback mechanism that reverts the managed device to the last known good configuration prior to any management connectivity loss. Mobility Master indicates if a device has recovered from a bad configuration through the <b>show switches</b> command output.</p>
<a href="#">Bulk Edit</a>	<p>Mobility Master supports the bulk edit that enables the user to upload multiple configurations at the same time.</p>
<a href="#">Configuration Hierarchy</a>	<p>Mobility Master contains a centralized, multi-tier architecture that provides a clear separation between management, control, and forwarding functions. The entire configuration for both the Mobility Master and managed devices is set up from a centralized point, simplifying and streamlining the configuration process. Mobility Master consolidates all-master, single master-multiple local, and multiple master-local deployments into a single deployment model.</p> <p>The following enhancements have been introduced for the Mobility Master configuration model:</p> <ul style="list-style-type: none"> <li>• Multi-tier configuration hierarchy</li> <li>• Centralized configuration</li> </ul>

New Features	Description
	<ul style="list-style-type: none"> <li>Centralized validation</li> <li>Efficient configuration distribution</li> <li>ZTP and branch support</li> <li>Recovery mechanisms for connectivity loss</li> <li>Centralized licensing</li> <li>New parser and CLI infrastructure</li> <li>Improved user interface</li> <li>Northbound APIs</li> </ul>
<a href="#">Configuration User Interface</a>	<p>The Mobility Master user interface runs on a flat hierarchy profile design that provides ease-of-use through a simple navigation model. The Mobility Master WebUI contains the following enhancements:</p> <ul style="list-style-type: none"> <li>Multi-level navigation menu</li> <li>Profile configuration model based off a single-page, flat hierarchy architecture, in which only a portion of the page is updated based on the action performed</li> <li>Primary and secondary tables</li> <li><b>Pending Changes</b> button to deploy or discard modifications</li> <li>Help mode to view help information for configuration fields</li> <li>Centralized hierarchy management</li> </ul>
<a href="#">Device Auto-Parking</a>	<p>Users can specify a default node to automatically push configurations to devices that are not mapped to a specific configuration node using the <b>configuration device default-node</b> command.</p>
<a href="#">Disable Console Access</a>	<p>A new command, <b>mgmt-user console-block</b>, is introduced to disable the console-login. The purpose of this command is to introduce an ability to lock down all console ports, for example, micro USB, mini USB on the managed device to enable high-level security. This also ensures that no Secure Shell (SSH) access is allowed at the remote branch office. The SSH is only allowed from the headquarters through the IPsec tunnel.</p>
<a href="#">Disaster Recovery</a>	<p>If auto-rollback from a bad configuration fails, and connectivity between a managed device and Mobility Master remains disrupted, users can enable <b>Disaster Recovery</b> mode on the managed device. <b>Disaster Recovery</b> mode grants users access to the <b>/mm</b> node of a managed device, while blocking any further configuration syncs from Mobility Master. This allows users to make local modifications on a managed device and restore connectivity to Mobility Master.</p>
<a href="#">Support for IKE Fragmentation</a>	<p>ArubaOS 8.0 supports the functionality where non-Aruba devices can fragment the large IKE_AUTH packets using the standards described in the <b>RFC 7383 - Internet Key Exchange Protocol Version 2 (IKEv2) message fragmentation</b> when the Aruba device acts as a responder and not as an initiator.</p>
<a href="#">IPFIX Support</a>	<p>IP Flow Information Export (IPFIX) can now exports data for the following attributes:</p> <ul style="list-style-type: none"> <li>Source IP</li> <li>Destination IP</li> </ul>

New Features	Description
	<ul style="list-style-type: none"> <li>● Protocol</li> <li>● Source L4 port</li> <li>● Source L4 port</li> <li>● Destination L4 port</li> <li>● Session start time</li> <li>● Session end time</li> <li>● Packet received</li> <li>● Byte received</li> <li>● Station mac</li> <li>● Station IP</li> <li>● AP Ethernet MAC</li> </ul>
<a href="#">IPsec Support</a>	<p>Starting from ArubaOS 8.0, IPsec support is enhanced to accommodate IPv6 which includes overlay networks across IPv4 and IPv6 IPsec Tunnels. In this release, IKEv2/IPsec support is extended to IPv6 for the following topologies:</p> <ul style="list-style-type: none"> <li>● Mobility Master</li> <li>● CPsec (Tunnel Mode only)</li> <li>● RAP (Tunnel Mode only)</li> <li>● Site-to-Site Crypto Map (Tunnel Mode only)</li> </ul>
<a href="#">LMS Configuration for AP Groups</a>	<p>ArubaOS 8.0 supports LMS, LMS IPv6, and backup LMS IP address configuration as part of the AP Group settings available in the WebUI.</p>
<a href="#">Loadable Service Module</a>	<p>The Loadable Service Module (LSM) provides an infrastructure that allows users to dynamically upgrade or downgrade individual service modules without requiring an entire system reboot. Services are delivered as individual service packages containing the version and instructions for loading and running the service. Service modules must be upgraded if there is a bug in the existing module or a newer version of the module has been released.</p> <p>The following service modules are LSM-capable:</p> <ul style="list-style-type: none"> <li>● AirGroup</li> <li>● AppRF</li> <li>● ARM</li> <li>● AirMatch</li> <li>● NBAPI</li> <li>● UCM</li> <li>● WebCC</li> <li>● WMS</li> </ul>

New Features	Description
<a href="#">Local WMS Termination for Managed Devices</a>	<p>If a managed device is installed at a location with strict bandwidth limitations and in a network topology where the managed device is geographically away from another managed device terminating APs, WMS services can be configured to locally terminate on the managed device instead of terminating on Mobility Master. Enable this feature with caution, as it may impact WMS device classification and IDS detection and protection on your network.</p>
<a href="#">MultiZone</a>	<p>The MultiZone feature allows AP to terminate to multiple managed devices that reside in different zones. A zone is a collection of managed devices under a single administration domain.</p>
<a href="#">Prefix Delegation</a>	<p>Starting from ArubaOS 8.0, prefix delegation can be used to assign a network address prefix to a customer site, as defined in IPv6 prefix delegation protocol (RFC 3769). The hosts at the customer site use this prefix to derive a unique IPv6 address using RA and SLAAC. Prefix delegation client uses DHCPv6 IA_PD to request and assign prefixes</p>
<a href="#">Remote Telnet or SSH Session</a>	<p>Starting from ArubaOS 8.0, an administrator can initiate a remote telnet or SSH session from Mobility Master to a remote host. The host can be a managed device or a non-Aruba host.</p>
<a href="#">SDN Controller</a>	<p>The Software Defined Networking (SDN) Controller provides an improved networking infrastructure to build, deliver, and manage features through the following enhancements:</p> <ul style="list-style-type: none"> <li>● Separation of control-plane and data-plane functions</li> <li>● Centralized manageability</li> <li>● Dynamic programmability of network devices</li> </ul>
<a href="#">Uplink Load Balancing</a>	<p>A managed device supports multiple 3G cellular uplinks in addition to its standard wired ports, providing redundancy in the event of a connection failure. WAN traffic can be balanced across two or more active uplinks from a managed device to a VPN concentrator (VPNC). The uplink load balancing feature supports both active and standby uplinks, so the traffic load can be balanced across two wired uplinks, even while the backup cellular uplink remains idle.</p>
<a href="#">Unified Communication and Collaboration</a>	<p>ArubaOS 8.0 introduces the following new UCC features:</p> <ul style="list-style-type: none"> <li>● Enables VoIP ALGs to run as a service on Mobility Master and managed devices need not run the same. This results in better scalability.</li> <li>● Enables real-time analysis of VoIP calls in upstream direction. This is the real-time analysis and UCC call quality statistics calculated based on VoIP stream captured at the managed device.</li> <li>● Multiple applications running simultaneously on the same client device can be identified and prioritized.</li> <li>● Supports Intelligent Call Handling (ICH). ICH monitors the channel utilization of all radios of the APs on the managed device. If the channel utilization exceeds beyond a configurable threshold on a radio, new UCC calls are not prioritized.</li> <li>● Supports Cisco Jabber. Mobility Master provides QoS and visibility for voice, video calls, and desktop-sharing sessions made using an unencrypted version of the Cisco Jabber client. UCM can uniquely identify and prioritize Cisco jabber voice, video calls, and desktop-sharing sessions.</li> </ul>

New Features	Description
	<ul style="list-style-type: none"> <li>• Supports Loadable Service Module. UCM is a Loadable Service Module. ALGs are completely decoupled from the managed devices. This enables faster innovation of VoIP services such as introduction of new ALGs and enhancements to existing features as they will become independent of the ArubaOS release version.</li> <li>• Provides a solution to the fanout problem in Lync/Skype for Business SDN API. In ArubaOS 6.x, Lyn/Skype for Business SDN Manager sent call information messages to every local controller in the network, regardless of whether the local controller is involved in the call or not. This additional processing is an unnecessary overhead on the local controller. In addition, the bandwidth utilization between the data center and remote location is not efficient. With the Mobility Master deployment, Lync/Skype for Business SDN Manager sends the call information messages to Mobility Master only.</li> <li>• Provides aggregation of statistical information at a centralized entity.</li> </ul>
<a href="#">Interference Metrics</a>	<p>This enhancement is introduced to resolve issues that occur with distributed channel/power algorithm, random channel assignment, and reduction in interference channel.</p>
<a href="#">WAN Interface Bandwidth Priorities</a>	<p>ArubaOS supports minimum bandwidth guarantees per traffic class, and allows critical delay-sensitive applications like voice and video to use more bandwidth and/or be scheduled with higher priority. Each interface can be associated with a scheduler profile, that supports four queues with different priority levels.</p>
<a href="#">Secondary Managed Device</a>	<p>The secondary managed device feature in ArubaOS 8.0.0.0 provides seamless connectivity by allowing an access point to terminate on a secondary managed device in the event of the primary managed device failing.</p>
<a href="#">Whitelist Management for APs and Managed Devices</a>	<p>Zero touch provisioning (ZTP) automates the deployment of APs and managed devices plug-n-play. The managed device learns the local configuration, global configuration, and license limits from Mobility Master and provisions itself automatically. ZTP offers the following advantages over a standard configuration:</p> <ul style="list-style-type: none"> <li>• simple deployment</li> <li>• reduced operational cost</li> <li>• limits to provisioning errors</li> </ul>
<a href="#">Customized Response</a>	<p>This feature allows you to add customized messages that will be displayed in case of an authentication failure.</p>
<a href="#">Enabling PortFast</a>	<p>A new parameter is introduced to enable PortFast/PortFast on Trunk to reduce the time taken for wired clients connected to an AP to detect the link before they send data traffic.</p>
<a href="#">Seamless Logon</a>	<p>The Seamless Logon feature enables you to login from the Mobility Master to a managed device without entering a password.</p>
<a href="#">OpenFlow Agent</a>	<p>OpenFlow agent interacts with a centralized SDN Controller using the OpenFlow protocol and translates OpenFlow commands into device specific actions.</p>

New Features	Description
<a href="#">Port Bounce for AP with Access Ethernet Ports</a>	Mobility Master provides support for the port bounce feature for APs with access ethernet ports. This feature enables a client to re-initiate a DHCP request when there is a VLAN change.
<a href="#">Protection from Adhoc Networks Using Valid SSID</a>	Mobility Master provides support for containing the adhoc networks that use a valid or protected SSIDs so that clients cannot connect to it.
<a href="#">Role-based Access and Authorization</a>	A new default role, <b>ap-provisioning</b> is introduced to permit access only to AP provisioning commands.
<a href="#">Clarity Synthetic</a>	Clarity Synthetic enables the controller to select and convert a supported access point to client mode. The converted AP acts like a Wi-Fi client and starts synthetic data transaction within the network to monitor and detect the network health.
<a href="#">Support for Self-Signed Certificate</a>	Mobility Master provides support for generating a new self-signed certificate ( <b>default-self-signed</b> ) to demonstrate the authentication of the managed device for captive portal and WebUI management access while booting.  <b>NOTE:</b> This is the default certificate used by Mobility Master and managed devices.

**Table 6:** *Enhancements in ArubaOS 8.0*

Enhancements	Description
<a href="#">Blocked Session</a>	The <b>Blocked</b> tab in <b>Dashboard Monitoring &gt; Traffic Analysis</b> page displays WebCC and AppRF sessions which are blocked by ACL through system logging.
<a href="#">Radius Accounting for IPv6 Clients</a>	Starting from ArubaOS 8.0, customers can monitor bandwidth usage by clients/hosts with IPv6 addresses, over RADIUS protocol. The <b>Framed-IPv6-Address</b> attribute is used in accounting start, stop, and interim packets. A host can have multiple IPv6 addresses and all of them are tracked to check the usage, for billing purpose.
<a href="#">Routing Traffic through Web Proxy</a>	When the Mobility Master needs to access data on the cloud or the internet, and if the internet bound traffic needs to pass through a proxy, execute the web-proxy server command. Once the command is executed the Mobility Master routes web (HTTP/HTTPS) traffic through the proxy server.
<a href="#">Uplink Health Check Improvements</a>	If the managed device health check feature is configured to use <b>UDP</b> probe mode, the health check feature can measure jitter on the connection to the remote host by sending and measuring packets at fixed intervals.
<a href="#">Whitelist DB Optimization</a>	ArubaOS 8.0 introduces a pull-based sync mechanism for the whitelist database (whitelist-DB), in which AP whitelist entries are only synced to the managed devices that require the entry. The pull-based sync mechanism is used when a RAP/CPsec AP terminates on a managed device or if a network is down during a whitelist push, which can prevent messages from going through to the managed devices. Entries can also be configured directly on a managed device for debugging purposes.
<a href="#">Wi-Fi Calling</a>	Mobility Master provides QoS for voice calls made using Wi-Fi Calling. UCM in Mobility Master can identify and prioritize calls made using Wi-Fi Calling. UCM also provides visibility for all voice calls made using Wi-Fi Calling.



# Fundamentals

Configure your Mobility Master and AP using either the Web User Interface (WebUI) or the Command Line Interface (CLI).

## WebUI

Mobility Master supports up to 320 simultaneous WebUI connections. The WebUI is accessible through a standard Web browser from a remote management console or workstation. The WebUI includes configuration tasks. The tasks are:

- Provision New APs— Campus AP or Remote AP configuration.
- Create a New WLAN— Create and configure new WLAN(s) and associate with an AP group.
- Define Wireless Intrusion Protection (WIP) Policy— Define WIP policies and assign to AP groups.
- Bulk Configuration Upload— The Bulk Edit template (in Excel sheet) on the managed device allows you to specify the static IP assignment for individual managed devices.
- Upgrade Controllers— Upgrade the managed devices.
- Reboot Controllers— Reboot the managed devices.
- Show Upgrade Status— Display the upgrade status of the managed devices.

In addition to the tasks, the WebUI includes a dashboard that provides enhanced visibility into your wireless network's performance and usage. This allows you to easily locate and diagnose WLAN issues. For details on the WebUI Dashboard, see [Dashboard Monitoring](#).

## CLI

The CLI is a text-based interface accessible from a local console connected to the serial port on the Mobility Master or managed device or through a Telnet or Secure Shell (SSH) session.



---

By default, you access the CLI from the serial port or from an SSH session. You must explicitly enable Telnet on your Mobility Master in order to access the CLI via a Telnet session.

---

When entering commands remember that:

- commands are not case sensitive
- the space bar completes your partial keyword
- the backspace key erases your entry one letter at a time
- the question mark ( ? ) lists available commands and options

## Remote Telnet or SSH Session from Mobility Master

An administrator can initiate a remote telnet or SSH session from the Mobility Master to a remote host. The host can be a Mobility Master, managed device, or a non-Aruba host.



---

This feature is supported from the SSH session of the Mobility Master.

---

To initiate a telnet session from the Mobility Master to a remote host:

1. Initiate an SSH session to the Mobility Master.
2. In the **enable** mode, execute the **telnet <host> [port <port-num>]** command.  
**host:** IPv4 or IPv6 address of the remote host.  
**port <port-num>:** Telnet port number of the remote host. This is an optional parameter.
3. Once successfully connected, the remote host prompts the credentials. Enter the remote host credentials.

To initiate an SSH session from the Mobility Master to a remote host:

1. Initiate an SSH session to the Mobility Master.
2. In the **enable** mode, execute the **ssh <username> <ip\_addr>** command.

**username:** Username of the remote host.

**<ip-addr>:** IPv4 or IPv6 address of the remote host.

Once successfully connected, the remote host prompts the credentials.

3. Enter the remote host credentials.

To end the remote host session, execute the **exit** command. The remote host displays the following message:

```
(host) [remote] #exit
Connection closed by foreign host.
(host) [mynode] #
```

## Limitations

This feature has few limitations. They are:

- This feature is supported from the SSH session of only the Mobility Master.
- There is an inactivity timeout for the CLI sessions. When an administrator initiates a remote session (inner) from the Mobility Master's SSH session (outer), and the remote session takes more time than the inactivity timeout session, the outer session times out although the inner session is active. The administrator has to log back in to the outer session once logged off from the inner session.
- Designated telnet client control keys do not work for remote telnet sessions. When an administrator initiates a remote telnet session (inner) from the Mobility Master's SSH session (outer), the designated telnet client control keys functions for the outer SSH session only. The administrator should designate unique control keys for each remote telnet sessions.

## Seamless Logon

The Seamless Logon feature enables you to login from the Mobility Master to a managed device without entering a password. The user can remotely login from a centralized location (Mobility Master) to any managed device and execute the show and action commands. To login to a managed device, execute the **logon <device-ip>** command on the Mobility Master CLI:

```
(host) [mynode] #logon 192.0.2.22
Last login: Tue Jul 12 04:34:37 2016 from 192.0.2.81
(host-md) #
```



---

ArubaOS 8.x does not support Seamless Logon in the master controller mode.

---

## System Requirements

Listed below are the minimum Hypervisor host system requirements for ArubaOS to run as a guest VM and the resources required for the VM to be functional:

**Table 7: System Requirements**

Host Requirements	Mobility Master	Virtual Mobility Controller
Quad-core Core i5 1.9 GHz CPUs (hyper-threading enabled)	8	4
Memory	16 GB	8 GB
Physical NIC ports <b>NOTE:</b> One NIC port is shared with the host management and the second is reserved for datapath.	2	2
Disk space	64 GB	32 GB



---

It is not recommend to over subscribe the processors, memory, and NIC ports on the VM.

---

## Other Specifications

The Mobility Master runs on a virtual machine that is deployed through an OVF/OVA file.

Prerequisites for deploying the Mobility Master:

- vSphere Client 5.1 or 5.5 must be installed on a Windows machine.
- vSphere Hypervisor 5.1, 5.5, or 6.0 must be installed on the server.
- An OVF/OVA template must be accessible from the ESXi host.
- VMware Enterprise Plus license must be installed on the Hypervisor.

## Supported Browsers

The following browsers are officially supported for use with the ArubaOS WebUI:

- Microsoft Internet Explorer 11 on Windows 7 and Windows 8
- Microsoft Edge (Microsoft Edge 38.14393.0.0 and Microsoft EdgeHTML 14.14393) on Windows 10
- Firefox 48 and higher on Windows 7, Windows 8, Windows 10 and Mac OS
- Apple Safari 8.0 or later on Mac OS
- Google Chrome

## Related Documents

The following guides are part of the complete documentation for the Aruba user-centric network:

- *ArubaOS 8.0.1.0 ArubaOS Release Notes*
- *ArubaOS Quick Start Guide*
- *ArubaOS User Guide*
- *ArubaOS CLI Reference Guide*
- *ArubaOS Migration Guide*
- *ArubaOS API Guide*

- *Aruba Mobility Master Licensing Guide*
- *Aruba Mobility Master and VMC Installation Guide*
- *Aruba Wireless Access Point Installation Guide*

## Conventions

The following conventions are used throughout this document to emphasize important concepts:

**Table 8:** *Typographical Conventions*

Type Style	Description
<i>italics</i>	This style is used to emphasize important terms and to mark the titles of books.
system items	This fixed-width font depicts the following: <ul style="list-style-type: none"> <li>• Sample screen output</li> <li>• System prompts</li> <li>• File names, software devices, and specific commands when mentioned in the text</li> </ul>
<b>commands</b>	In the command examples, this bold font depicts text that you must type exactly as shown.
<arguments>	In the command examples, italicized text within angle brackets represents items that you should replace with information appropriate to your specific situation. For example: <pre># send &lt;text message&gt;</pre> In this example, you would type "send" at the system prompt exactly as shown, followed by the text of the message you wish to send. Do not type the angle brackets.
[optional]	Command examples enclosed in brackets are optional. Do not type the brackets.
{Item A   Item B}	In the command examples, items within curled braces and separated by a vertical bar represent the available choices. Enter only one choice. Do not type the braces or bars.

The following informational icons are used throughout this guide:




---

Indicates helpful suggestions, pertinent information, and important things to remember.

---




---

Indicates a risk of damage to your hardware or loss of data.

---




---

Indicates a risk of personal injury or death.

---

## Contacting Support

**Table 9:** *Contact Information*

Main Site	<a href="http://arubanetworks.com">arubanetworks.com</a>
Support Site	<a href="http://support.arubanetworks.com">support.arubanetworks.com</a>
Airheads Social Forums and Knowledge Base	<a href="http://community.arubanetworks.com">community.arubanetworks.com</a>
North American Telephone	1-800-943-4526 (Toll Free) 1-408-754-1200
International Telephone	<a href="http://arubanetworks.com/support-services/contact-support/">arubanetworks.com/support-services/contact-support/</a>
Software Licensing Site	<a href="http://hpe.com/networking/support">hpe.com/networking/support</a>
End-of-life Information	<a href="http://arubanetworks.com/support-services/end-of-life/">arubanetworks.com/support-services/end-of-life/</a>
Security Incident Response Team	Site: <a href="http://arubanetworks.com/support-services/security-bulletins/">arubanetworks.com/support-services/security-bulletins/</a> Email: <a href="mailto:sirt@arubanetworks.com">sirt@arubanetworks.com</a>

The ArubaOS 6.x and earlier release trains consist of a flat configuration model containing global and local configurations. Global configurations are applied to the master controller and can only be propagated to each local controller through the master. The respective local configurations are applied directly to each master or local controller.

Mobility Master (ArubaOS 8.0) uses a centralized, multi-tier architecture under a brand new UI that provides a clear separation between management, control, and forwarding functions. The entire configuration for both the Mobility Master and managed devices is set up from a centralized point, thereby simplifying and streamlining the configuration process. Mobility Master consolidates all-master, single master-multiple local, and multiple master-local deployments into a single deployment model.

Mobility Master (mm) takes the place of a master controller in the network hierarchy. A single Mobility Master or a cluster of Mobility Masters oversees controllers that are colocated (on-premise local controllers or off-campus branch office local controllers). Each Mobility Master cluster is referred to as a Mobility Master domain. All the controllers that connect to Mobility Master act as managed devices (md). In a large campus, there may be multiple Mobility Master domains.

This section provides details on the following topics:

- [Enhancements](#)
- [Configuration Hierarchy](#)
- [Centralized Configuration](#)
- [Configuration Validation](#)
- [Configuration Distribution](#)
- [ZTP and Branch Support](#)
- [Redundancy](#)
- [Serviceability](#)
- [Auditing](#)
- [Custom Certificates](#)
- [User Interface](#)

## Enhancements

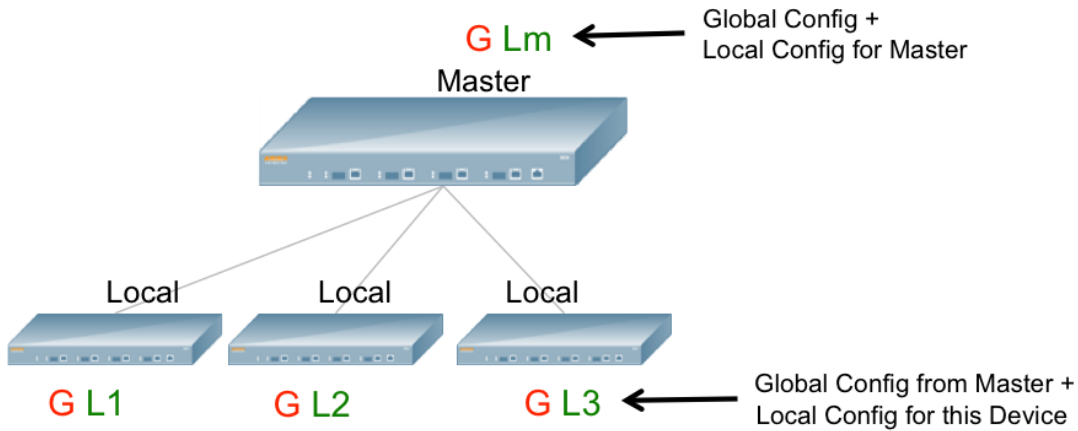
The following enhancements have been made for the Mobility Master configuration model:

- Multi-tier configuration hierarchy
- Centralized configuration
- Centralized validation
- ZTP and branch support
- Efficient configuration distribution
- New parser and CLI infrastructure
- Northbound APIs

## Configuration Hierarchy

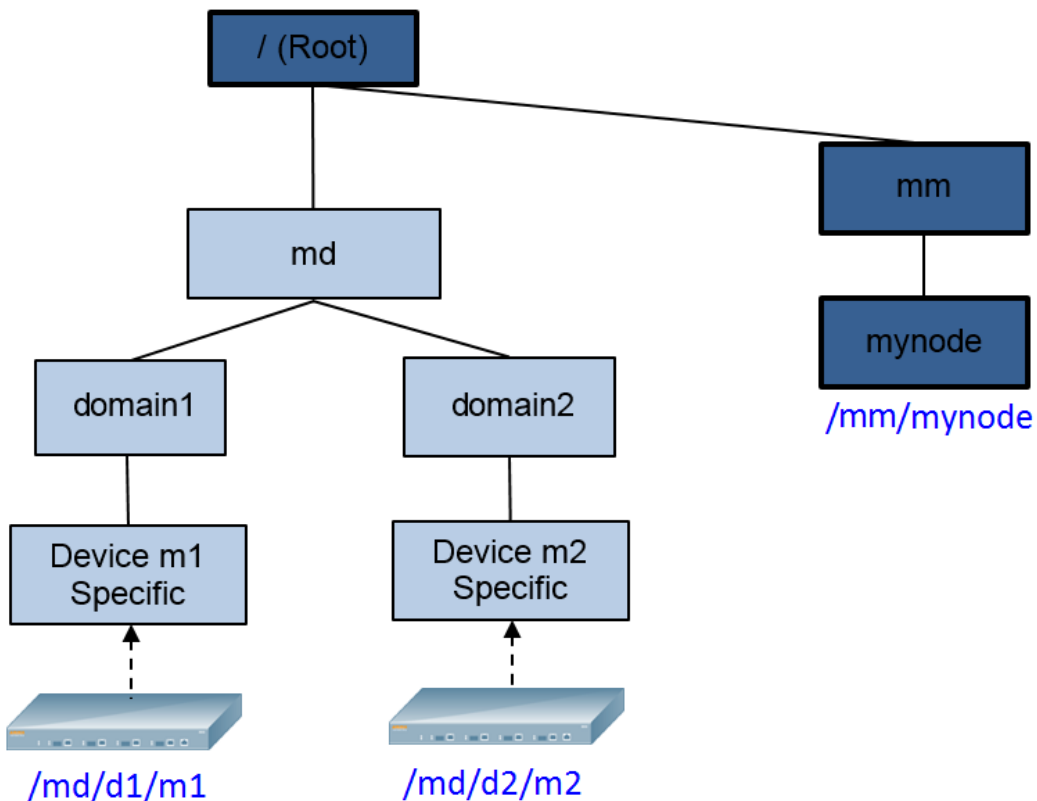
In the ArubaOS 6.x and earlier release trains, multiple local controllers are forced to share a global configuration or require users to set up multiple master controllers and duplicate configuration information to apply different global configurations to different local controllers.

**Figure 1** Configuration Hierarchy



The Mobility Master hierarchy simplifies the configuration process by supporting multiple configurations for multiple deployments using a single master controller. Configuration elements can be mapped to one or more end devices, such as a managed device or VPN concentrator. Common configurations across devices are extracted to a shared template, which merges with device-specific configurations to generate the configuration for an individual device.

**Figure 2** Example of the Configuration Hierarchy



[Figure 2](#) provides an example of the configuration hierarchy. The solid lines represent the hierarchy, the dotted arrows represent the device mapping, and each box represents a node in the hierarchy. When a device is added to Mobility Master, it must be mapped to a node or node-path in order to inherit configurations from the hierarchy. An explicit configuration node is also created for each device so that any device-specific configurations can be added directly to that node. Any device that is managed by Mobility Master is known as a managed device. For example, device **m2** in [Figure 2](#) retrieves all device-specific configurations from the **Device m2 Specific** node. Since the **Device m2 Specific** node is mapped to the **domain2**, **md**, and **Root** nodes, the device also receives configurations from those nodes.

Each node contains a unique combination of common and device-specific configurations. The root node appears by default upon logging in to Mobility Master CLI. Additional nodes can be created using the **configuration node** command. To access a particular node, execute the **change-config-node <node-path>** command.

The configuration hierarchy contains the following nodes and node structure:

**Table 10: Nodes and Node Structure**

Category	Node Name	Node Description
Mobility Master	/	Configurations common to Mobility Master and its managed devices (the root node). <b>NOTE:</b> Configuration changes are not allowed on the root node.
	/md	Configurations common to all managed devices. The user can create additional nodes under this node.
	/mm	Configurations common to the primary and standby Mobility Master (VRRP pair).
	/mm/mynode	Configurations specific to a particular Mobility Master. This can only be edited on the respective Mobility Master.
Stand-alone Controller	/mm	Configurations common to the primary and standby stand-alone controllers (VRRP pair).
	/mm/mynode	Configurations specific to a particular stand-alone controller. This can only be edited on the respective stand-alone controller.
Managed Device	/mm	Configurations synced from Mobility Master.
	/mm/mynode	Configurations made locally on the managed device (remote override). <b>NOTE:</b> These nodes cannot be viewed or accessed on the Mobility Master.



The term "mm" refers to Mobility Master and "md" refers to managed device.

Configurations for a node are obtained by traversing the node-path from the root node to the given node. For example, the **m1** device in [Figure 2](#) receives configurations from all nodes along the **Root > md > domain1 >**



**Device m1 Specific** node-path. Configurations that are set lower in the hierarchy (child node) can have more precedence than the same configurations set higher in the hierarchy (parent node), depending on the configuration type. In a single-instance configuration, such as the ESSID name, configurations from a child or device-specific node override common configurations from a parent node. In a multi-instance configuration, such as a server in an Auth Server group, configurations from a child node are placed in addition to the parent node configuration. For example, if a parent node specifies two servers in the Auth Server group, and the child node specifies three servers in the same group, the device is provisioned with a total of five servers.

The configuration hierarchy is not the same as the physical topology. The hierarchy provides a simple way to organize configurations so that configuration elements can be shared across multiple devices without being duplicated. Configurations that are added to the root node, for example, are applied to all nodes within the hierarchy, while configurations that are only applied to a specific region override configurations for the corresponding child nodes. Order-dependent configurations, however, cannot be overridden. These configurations can only be set up once in the network hierarchy. Configuration hierarchies are tailored and organized to meet the unique needs of each customer.

## Mobility Master Configuration

The Mobility Master that provides this configuration service to other devices in the network also contains its own configuration. The Mobility Master configuration is obtained through nodes in the hierarchy labeled **/mm** or **/mm/mynode**. Configurations under the **/mm** node, which are shared by the redundant Mobility Master pair (primary and standby Mobility Masters), are synced to the standby Mobility Master. Configurations under **/mm/mynode** are synced to individual Mobility Master devices.

## Allowed Node Operations

The following node operations are allowed on Mobility Master:

- **Create Node:** Creates a new node as the child of an existing node in the configuration hierarchy (system-generated or user-created)
- **Add Device:** Associates a device to an existing node in the hierarchy. This device inherits configurations from all nodes between the root node and the device (node-path).
- **Delete Node:** Deletes an existing user-created node or node without any child nodes. System-generated nodes cannot be deleted. Only leaf nodes without any child nodes can be deleted.
- **Delete Device:** Deletes a currently associated device from the configuration hierarchy. This will cause the device to reload and erase all configurations received from Mobility Master.
- **Clone Node:** Copies the configuration of an existing node into a new node. The new node is created as a child of an existing node in the hierarchy.

## Access Permissions

The Mobility Master management domain can be large and widespread across various geographic regions. Multiple admin users should be authorized to make changes to the configuration in order to simplify the management process between different regions. The legacy ArubaOS management domain grants access to admin users to modify any configuration in the system, which can impact both Mobility Master and/or any managed device managed by the master. Mobility Master limits the editing scope of the admin user to individual node-paths within the configuration hierarchy.

Each management user is granted editing permissions for a given node, allowing the user to modify the configuration for that node and any child node within its node-path. The user, however, cannot modify any parent nodes or nodes on a different path in the hierarchy. Users can view configurations for any node in the hierarchy to refer to a parent node configuration or verify that the derived configuration for a device matches the parent node configuration.

- Management users that are configured under the root (**/**) or Mobility Master (**/mm**) nodes are granted editing permissions for Mobility Master.
- Management users that are configured under mynode (**/mm/mynode**) can modify configurations under **/mm/mynode** for the respective Mobility Master, stand-alone controller, or managed device.
- Management users that are configured under a managed device can modify configurations for that managed device.
- Only the management users that are configured under the root node can modify configurations on both Mobility Master and managed devices.

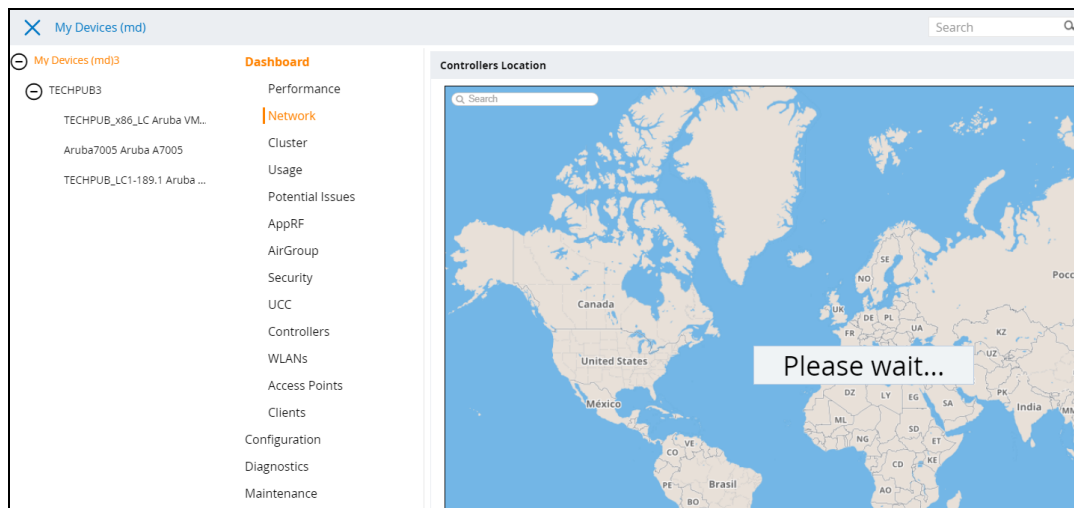
## Centralized Configuration

Mobility Master uses a centralized configuration application to maintain all configurations under the management domain, eliminating the use of multiple points of contact to apply global and local configurations to each managed device. The distinction between global and local configurations is no longer applicable, as any configuration can be applied anywhere in the system through the centralized configuration application. Instead, configurations can be organized by placing all common configurations at a higher level of the hierarchy (for example, **mm** on [Figure 3](#)), and all device or group-specific configurations at the lower levels (for example, **mynode** on [Figure 3](#)).



Order-dependent configurations, such as roles and ACLs, cannot be overridden. These configurations can only be set up once in the network hierarchy.

**Figure 3** The Configuration Hierarchy Viewed in the WebUI



Example of the configuration hierarchy:

```
(host) [mynode] #show configuration node-hierarchy
Configuration node hierarchy
-----
Config Node          Type
-----
/                    System
/md                  System
/md/00:0c:29:b0:12:93 Device
/md/test             User
/md/test/00:0c:29:3c:11:91 Device
/mm                  System
/mm/mynode           System
```

## Validation and Application Processes

When a user enters a configuration into a managed device, the configuration is validated. The validated configuration is accepted by the system but does not take effect. When the configuration is committed, it takes effect and is stored in the persistent memory, allowing users to verify the configuration before making it operational.

This separation of validation and application processes is applied to both Mobility Master and the managed devices. Since each node can be managed by a different admin user, the commit operation is executed on a per-node basis. The commit operation also follows the configuration hierarchy. For example, if a configuration has a dependency, the dependent configuration must be present on that node or one of the parent nodes in order for it to succeed.

Configurations are classified as **pending config** or **committed config** on each node. A pending config refers to a configuration that is validated on a node, but not yet committed. A committed config refers to all configurations entered on the node that are committed by the user. Users can view pending configurations at any time to commit, purge, or leave the configuration uncommitted. Pending configurations are only allowed on one node at any given time in a given configuration sub-tree.

Example of a committed configuration:

```
(host) [mynode] #show configuration committed /md

Thu Jun 09 12:10:56.167 2016
ip access-list mac policy
!
ip access-list eth eth
!
ip access-list session apprf-guestthistime-guest-logon-sacl
!
ip access-list session apprf-server-derived-sacl
!
ip access-list session apprf-newest-sacl
!
ip access-list session newPolicy
!
user-role guestthistime-guest-logon
access-list session logon-control
access-list session captiveportal
!
user-role newest
!
user-role server-derived
!
interface gigabitethernet 0/0/0
```

## Configuration Validation

Mobility Master provides a simple and organized validation process using a centralized validation model that performs various types of validations for different targets. Configuration validation falls under one of the following categories:

- **Syntax Validation:** Basic parser validations (for example, making sure the syntax of a command is correct, the data type is correct, or a value is within a valid range).



---

Roles, ACLs, and pools (DHCP, VLAN, tunnel, and NAT) must be written in lower-case. Passwords, crypto keys, and ESSIDs can be written in both upper-case and lower-case.

---

- **Semantic Validation:** Custom application-specific validations (for example, dependency checks across commands or instance count limits). Dependency checks are limited to the nodes from which the target device is inheriting the configuration.
- **Platform Validation:** Platform model-specific validations (for example, determining which features are supported on a platform or the type and count of ports on a platform)



Validation is not available on the setup dialogue. Users must manually verify the setup dialogue information for each managed device.

## Validation Failures

If a command does not pass validation, it is rejected and will not be included in the pending configuration for that node. If a new device is added that cannot support an existing configuration, the device add is rejected.

## Configuration Distribution

Mobility Master includes two types of configuration distributions to the managed devices:

- Partial Configuration Synchronization
- Full Configuration Sync

### Partial Configuration Synchronization

When a user attempts to commit a configuration on a node in the Mobility Master hierarchy, a partial configuration is generated for that node and all of its child nodes, and the global configuration identifier (config-id) increases by one. The partial configuration contains the delta of valid configurations made since the previous (successful) configuration commit. If a configuration has been deleted from a given node but still appears on a parent node, the configuration is inherited and included in the partial configuration for that node.

Mobility Master distributes the partial configuration to each managed device that is impacted by the configuration change. When the configuration is applied to the device successfully, the config-id of the managed device is updated with the latest number sent by Mobility Master. The updated config-id is communicated back to Mobility Master through the next heartbeat message, completing the partial configuration process.

### Full Configuration Synchronization

When a new device is added to Mobility Master, Mobility Master sends a full effective device configuration to the managed device on which the device is attached. The resulting configuration and **config-id** are sent to the corresponding device.

After the configuration has been applied to the device successfully, the **config-id** of the managed device is updated with the latest number sent by Mobility Master. The updated **config-id** is communicated back to Mobility Master through the next heartbeat message, thereby completing the configuration process.

Example of a full effective device configuration:

```
(host) [mynode] #show configuration effective /md

Thu Jun 09 12:12:07.875 2016
crypto-local pki ServerCert default-self-signed default-self-signed
crypto-local pki PublicCert master-ssh-pub-cert master-ssh-pub-cert
ip access-list mac policy
!
ip access-list eth eth
!
ip access-list eth validuserethacl
permit any
```

```
!  
!  
ip access-list route uplink-lb-cfg-racl  
!  
aaa tacacs-accounting  
!  
netsservice svc-smb-udp udp 445  
netsservice vnc tcp 5900 5905  
netsservice svc-noe udp 32512 ALG noe  
netsservice svc-cfgm-tcp tcp 8211  
netsservice svc-netbios-ssn tcp 139  
netsservice svc-syslog udp 514
```

## Bulk Edit

The bulk edit support feature enables you to do a bulk configuration in the Mobility Master. This option helps reduce the time taken to perform configuration tasks individually. Follow the steps below to do a bulk edit:

1. In the **Managed Network** node hierarchy, navigate to **Configuration > Tasks > Bulk configuration upload**.
2. Click **Download** sample template.
3. Enter values in the fields provided in the template.
4. Save the file.
5. Select **Browse** and navigate to the path where the template is stored.
6. Click **Submit**. The **Bulk Configuration Status** pop up is displayed with the status of the configurations that are being applied. Once the configurations are applied successfully, a message confirming that the file upload was successful is displayed. The next pop up displays the following details:
  - **Timestamp**
  - **Status**
  - **Number of devices updated**
  - **Total new devices added**



---

If the configurations are not applied successfully, the **Bulk Configuration Status** pop up displays the reason for the failure and the managed device will rollback to the previous configuration.

---



---

When devices are added using the bulk edit feature, each template file can include up to 400 devices.

---

## ZTP and Branch Support



---

Throughout this section, a branch controller is referred to as a managed device.

---

Zero Touch Provisioning (ZTP) automates the managed device deployment process, removing the need for professionals to deploy managed device on remote sites. Factory-default managed device auto-discover Mobility Master, join the central configuration application, download configurations from Mobility Master, and become operational without requiring any user intervention. Users deploying these devices are only required to handle the physical wiring (for example, the power supply or network connectivity).

### Branch Support

The branch support solution introduced in ArubaOS 6.4.3 includes the auto-bootstrap of managed device and configurations downloaded from the master controller. With a centralized configuration platform and flexible

hierarchy model, Mobility Master introduces the following enhancements to the branch solution:

- Mobility Master supports the complete set of commands from a central configuration application, or central configurator.
- ZTP support is extended to campus and branch deployments. The local role has been eliminated, extending the branch role to support other deployments as a managed device.
- More deployment scenarios are supported, allowing for flexible location and reachability options for the central configurator, which can reside within a data center or DMZ.
- A consistent hierarchical configuration model is used for both campus and branch deployments.
- IP Pool carving is integrated into the hierarchy with added flexibility.
- Users can apply device-specific configurations directly to a device-specific node without requiring a separate configuration group with the new configurations. Support for the **bulkedit** feature has been extended to include more configuration types and provide a simple mechanism to specify device-specific configuration under one location.
- Managed devices authenticate Mobility Master using the self-signed certificate of Mobility Master, which can be downloaded from Aruba Activate.
- Dynamic pool management is extended to carve addresses for VLAN interfaces that do not run a DHCP server. The VLAN Pool function has been added to separate user VLANs from controller IP VLANs when the DHCP server only runs on the user VLANs. DHCP pool carving is also integrated into the existing DHCP pools, making all static DHCP pool configurations available for dynamically carved DHCP pools.



The Controller IP VLAN for a managed device must be set manually if the managed device is using a DHCP IP.

Managed devices obtain the central configurator's IP address through Aruba Activate or the Setup Dialog. The central configurator is authenticated by the managed devices using a factory certificate, custom certificate, or PSK. For more details on ZTP and branch support, see [Managed Devices at Branch Offices](#).

The following tables summarize the options that are available for various deployment scenarios:

**Table 11:** *Deployments with a Configurator in a Demilitarized Zone (DMZ)*

Provisioning Type		Auto		Manual			
ZTP Mode		Activate		Setup Dialog Box (Mini/Full)			
Authentication Method		Factory Certificate	Hybrid Certificate	Factory Certificate	Custom Certificate	Hybrid Certificate	PSK
Managed Device	Master						
7xxx	7xxx	✓	x	✓	✓	x	✓
7xxx	Mobility Master	x	✓*	x	✓	✓**	✓

Provisioning Type		Auto		Manual			
x86	7xxx	x	x	x	✓	✓***	✓
x86	Mobility Master	x	x	x	✓	x	✓
✓ Deployment that contains a configurator in a DMZ x Deployment that does not contain a configurator in a DMZ							
* Mobility Master authenticates 7xxx using a factory certificate; 7xxx authenticates Mobility Master using a custom/self-signed certificate downloaded automatically from Activate ** Mobility Master authenticates 7xxx using a factory certificate; 7xxx authenticates Mobility Master using a manually uploaded custom/self-signed certificate *** x86 authenticates 7xxx using a factory certificate; 7xxx authenticates x86 using a manually uploaded custom/self-signed certificate							



A Hybrid certificate implies that Mobility Master authenticates a device using a factory certificate, and a device authenticates Mobility Master using a custom/self-signed certificate.

**Table 12: Deployments with a Configurator NOT in a DMZ**

Provisioning Type		Auto		Manual			
ZTP Mode		Activate		Setup Dialog Box (Mini/Full)			
Auth Method		Factory Certificate	Hybrid Certificate	Factory Certificate	Custom Certificate	Hybrid Certificate	PSK
Managed Device	VPN Concentrator						
7xxx	7xxx	✓	x	✓	✓	x	✓
x86	7xxx	x	x	x	✓	✓*	✓
7xxx	Non-Aruba	x	x	x	✓	x	✓
x86	Non-Aruba	x	x	x	✓	x	✓
✓ Deployment that contains a configurator NOT in a DMZ x Deployment that does not contain a configurator outside the DMZ							
* x86 authenticates 7xxx using a factory certificate; 7xxx authenticates x86 using a manually uploaded custom/self-signed certificate							

Mobility Master also communicates with the Activate server to obtain a whitelist of managed devices, the configuration nodes mapping to the devices, the controller model, and (optional) VPN concentrator

information. This information can also be entered manually as part of the **configuration device** command that is used to add devices to a configuration hierarchy. Mobility Master validates the end devices with the whitelist and pushes the configuration based on the device-configuration node mapping.

By default, a device that is not mapped to any configuration node does not receive any configuration. The user may specify a default node to automatically push configurations to such devices using the **configuration device default-node** command.

## Redundancy

Mobility Master supports the Virtual Router Redundancy Protocol (VRRP) for master redundancy. The entire configuration hierarchy is synced from the primary Mobility Master to the redundant Mobility Master, except any configurations under **/mm/mynode**. Configurations common to both the primary and redundant Mobility Masters are placed under the **/mm** node so that they can be synced to the redundant controller. Configurations specific to individual Mobility Masters must be placed under **/mm/mynode** on the respective Mobility Master. For example, IP address and VRRP configurations are different for each device under Mobility Master. These configurations can be placed under the respective **/mm/mynode** for each device, while configurations for Mobility Master services can be placed under the **/mm** node.

### Initial Redundancy Configuration

When redundancy is configured for the first time or the peer IP is modified, it is considered to be in the initial redundancy relationship establishment state. After the VRRP exchange determines the role for each Mobility Master in this state, the standby Mobility Master cleans up its existing configuration state, except mynode, and rebuilds the configuration hierarchy using the configuration synced from the primary Mobility Master.

### Incremental Configuration Changes

After the primary and standby Mobility Masters have performed the initial synchronization and reached a stable state, any incremental configuration changes committed on the primary Mobility Master results in a configuration sync with the standby.

Any changes made to mynode on the primary Mobility Master are not synced to the standby Mobility Master. The standby Mobility Master contains its own version of the mynode configurations, and so these changes must be made directly to the standby Mobility Master. Configuration changes for other nodes are not permitted on the standby Mobility Master. When mynode is configured on the standby Mobility Master, the config-id does not change because the modifications are local.

## Serviceability

Managed devices are always serviceable from the centralized management location. When a managed device boots up for the first time under the factory default state, it auto-provisions and establishes connectivity to Mobility Master through ZTP. Managed devices can also be provisioned manually through the setup dialog box. Managed devices can encounter connectivity loss due to bad configurations, network connectivity issues, and so on. The system attempts to recover from these situations when possible.

### Bad Configuration Recovery

Certain configurations, such as those in the following list, can interfere with the connectivity between managed devices and Mobility Master:

- Uplink port shut
- Partially configured uplink VLAN
- Limiting bandwidth contract policy



- Bad ACL

Bad configurations can be caused by simple typo errors. Even if the user discovers the error, the bad configuration may have already caused connectivity loss, preventing the user from pushing the correct configuration to the managed device.

Mobility Master supports an auto-rollback mechanism that reverts the managed device to the last known good configuration prior to the management connectivity loss. Mobility Master also indicates if a device has recovered from a bad configuration through the **show switches** command output. The output for this command labels the **Configuration State** for the managed device as **CONFIG ROLLBACK** if the device has recovered connectivity using the rollback configuration. When the user fixes the bad configuration on Mobility Master, the managed device recovers automatically, and the state changes to 'UPDATE SUCCESSFUL'.

Example output for the **show switches** command:

```
(host) [mynode] #show switches

Thu Jun 09 12:13:45.735 2016

All Switches
-----
IP Address      IPv6 Address  Name          Location      Type      Model
Version        Status        Configuration State  Config Sync Time (sec)  Config ID
-----
--
192.192.192.1  None          TECHPUB_MASTER  Building1.floor1  master  ArubaMM
8.0.0.0-svcs-ctrl_55038  up          UPDATE SUCCESSFUL  0
192.192.192.2  None          TECHPUB_STANDBY  Building1.floor1  standby  ArubaMM
8.0.0.0-svcs-ctrl_55038  up          UPDATE SUCCESSFUL  10
192.192.189.1  None          TECHPUB_LC1_189.1  Building1.floor1  MD      Aruba7010
8.0.0.0-svcs-ctrl_55038  up          UPDATE SUCCESSFUL  0
192.192.192.3  None          TECHPUB_x86_LC  Building1.floor1  MD      VMC-TACTICAL
8.0.0.0-svcs-ctrl_55038  up          UPDATE SUCCESSFUL  0
192.192.189.2  None          TECHPUB_LC2_189.2  Building1.floor1  MD      Aruba7005
8.0.0.0-svcs-ctrl_55038  up          UPDATE SUCCESSFUL  0
Total Switches:5
```

## Disaster Recovery

If auto-rollback from a bad configuration fails, and connectivity between the managed device and Mobility Master remains disrupted, users can enable **Disaster Recovery** mode on the managed device using the **disaster-recovery on** command. Under the regular mode, the **/mm** node downloads configurations from Mobility Master that cannot be modified directly on each managed device. **Disaster Recovery** mode grants users access to the **/mm** node through the managed devices while blocking any further configuration syncs from Mobility Master. With full control of the **/mm** node, users can make local modifications on each managed device to restore connectivity to Mobility Master.




---

Local configurations are only used for debugging purposes and are not visible on the Mobility Master.

---

After connectivity is restored and verified, the user must fix the configuration on Mobility Master and exit the **Disaster Recovery** mode. When the user exits **Disaster Recovery** mode from the managed device, a full configuration sync is triggered between the managed devices and Mobility Master, which now contains the latest effective configurations.

Enabling **Disaster Recovery** mode in the CLI:

```
(host-md) #disaster-recovery on
*****
Entering disaster recovery mode
*****
```

```
(DR-Mode) [mm] #
```

Disabling **Disaster Recovery** mode in the CLI:

```
(DR-Mode) [mm] #disaster-recovery off
```

## Initial Provisioning Recovery

If the managed devices fail to connect to Mobility Master on multiple attempts during the initial provisioning process (for example, when the Mobility Master IP or fully qualified domain name (FQDN) is entered incorrectly in Aruba Activate), the managed device deletes all provisioning information and restarts the auto-provisioning process. The user is expected to correct the provisioning information under Aruba Activate. After the provisioning information is corrected, the managed device automatically recovers during the next auto-provisioning attempt.

## Auditing

Configurations undergo an exhaustive validation process on Mobility Master before they are pushed to the managed device (see [Configuration Validation](#) for more details). When a configuration is validated successfully but fails to apply to the managed device, the Mobility Master auditing feature provides visibility into these configuration failures. Users can understand why the command was not applied to the managed device and potentially modify the configuration to fix the error. However, there could be instances when configuration cannot be applied on the managed device. These failures are generally due to runtime state in the network.

When there is a failure event, a red marked sign under **ALERT** is displayed on the Dashboard. To get details on the failure navigate to **Diagnostic > Logs > Audit**.

If a configuration fails to apply to a managed device, the managed device sends an alert to Mobility Master indicating the command that has failed and the reason for failure. Users can view the first failed command and a list of failed devices on Mobility Master using the **show switches** command. Users can also view the complete list of pending commands using the **show configuration failure** command.

Commands can be fixed manually (for example, user modification) or automatically (for example, a busy application starts responding). When a failed command is fixed, the managed device clears the failure alert, which allows Mobility Master to remove the failure from the list of failed devices. The **show switches** command output updates the status of these failed devices to 'UPDATE SUCCESSFUL'.

Example output for the **show configuration failure** command:

```
(host) [mynode] #show configuration failure
```

```
Configuration Failure
```

```
-----
```

```
Command: interface vlan 10 ip address dhcp-client
```

```
Process: Layer2/3
```

```
Message: Vlan 10 no longer exists
```

```
Total Failures: 1
```

## Local Configuration on the Managed Device

The entire configuration for a managed device is expected to be set up centrally from Mobility Master. However, users can make configuration changes locally on each managed device for debugging purposes. Since this mechanism is only used for debugging purposes, these configuration changes are not visible from Mobility Master. The local configurations are merged with the configurations from Mobility Master to create an effective configuration for the managed device. Configurations made directly on the managed device take precedence over the configurations received from Mobility Master. Users can only view these configurations on the respective managed device using the **show configuration committed** command.

## Default Configuration

The factory default configuration appears in the root node of the Mobility Master hierarchy. The root node is not editable by the user. Any modifications to the default configuration must be made on the lower nodes.

## AP Master Considerations

When an existing deployment is migrated to Mobility Master, the device currently serving as the AP master can continue to serve as the AP master after migration. If a local controller acts as the AP master and converts into a managed device during migration, the corresponding AP group and system profile configurations must also be migrated to the new hierarchy so that the controller can continue to inherit those configurations. If a master controller acts as the AP master and converts into a managed device during migration, the controller continues to inherit all corresponding configurations to avoid making any changes to the AP boot parameters. If an AP master device is removed from the network, the corresponding configurations must be moved to another node in the hierarchy, and the AP's **master\_ip** must be mapped to the new device. Mobility Master cannot be used as the AP master since APs are not allowed to terminate on a Mobility Master. If the AP manager on the Mobility Master receives an AP HELLO message, the message is dropped. Mobility Master images are no longer bundled with any AP images.

## Custom Certificates

Custom certificates can be uploaded to the end devices managed by Mobility Master in one of two ways:

- The certificate is uploaded directly to the end device. This option is only valid for stand-alone controllers and is not supported for managed devices.
- Certificates are stored on Mobility Master and uploaded to the respective end devices when the devices connect at startup.

Certificates can also be uploaded to end devices through the CLI. The following commands must only be executed on a Mobility Master or stand-alone controller:

```
copy scp: <IPAddr> <username> <FilePath/OriginalFile> flash: <CADestinationName>
crypto pki-import pem trustedCA < CADestinationName> <CAOriginalFile>
```

```
copy scp: <IPAddr> <username> <FilePath/OriginalFile> flash: <ServerDestinationName>
crypto pki-import pfx ServerCert <ServerDestinationName > <ServerOriginalFile> password
```

```
conf t
crypto-local pki TrustedCA < CADestinationName > <CAOriginalFile>
crypto-local pki ServerCert <<ServerDestinationName > <ServerOriginalFile>
end
```

## Centralized Licensing

Mobility Master contains a centralized licensing server that supports multiple license pools, allowing users to apply a different set of licenses to each group of devices with common feature requirements.

By default, Mobility Master is configured with only one license pool on the root node, which contains all Mobility Master licenses. If no additional pools are created, all devices in the hierarchy share the single license pool. Users can add a new pool to any node in the hierarchy, and all devices within the subsequent node-path (child nodes) are included in that license pool. Devices that are not assigned to a license pool share the licenses that have not already been allocated to any user-defined pool.

Refer to the *Aruba Mobility Master Licensing Guide* for more details on the Mobility Master's centralized licensing architecture.

## User Interface

Mobility Master can be accessed through three different interfaces for maximum visibility and functionality:

- Command Line Interface
- WebUI
- JSON APIs

### Command Line Interface

Though the Mobility Master CLI remains largely similar to the CLI used in the ArubaOS 6.x and earlier release trains, the following changes have been made:

- The Mobility Master architecture spawns a new CLI session every time a user logs in to the CLI through Telnet, SSH, or Console. Since each CLI session is processed independently, multiple sessions do not block one another.
- New commands and parameters have been added to support new functions and provide increased visibility. See the *ArubaOS CLI Reference Guide* for more details.
- A small set of existing commands has been modified for consistency and concision.
- Configurations must be performed in the context of a node in the configuration hierarchy. Users with the necessary privileges can change the node context on the CLI prompt.
- Users are required to commit configurations on Mobility Master before the configurations can be pushed and applied to the device.

### WebUI

ArubaOS 8.0 supports a user interface that allows users to configure, manage, upgrade, and debug the system. The new configuration hierarchy is also managed through the UI. For more details, refer to [Configuration User Interface](#).

### JSON APIs

JSON APIs are exposed for all configuration objects in Mobility Master and client location information from the Analytics and Location Engine (ALE). Configuration APIs allow users to send configurations to Mobility Master and view those modifications through their own management system (CLI or WebUI). APIs in an operational state are also exposed. ALE APIs return client location information through the ALE server. Though most of this data is structured in the JSON format, some data may be arranged in a pre-formatted string. For more details on JSON APIs, refer to the *ArubaOS 8.0 NBAPI Guide*. For more information about ALE APIs, refer to the *Analytics and Location Engine 2.0.0.x API Guide*.

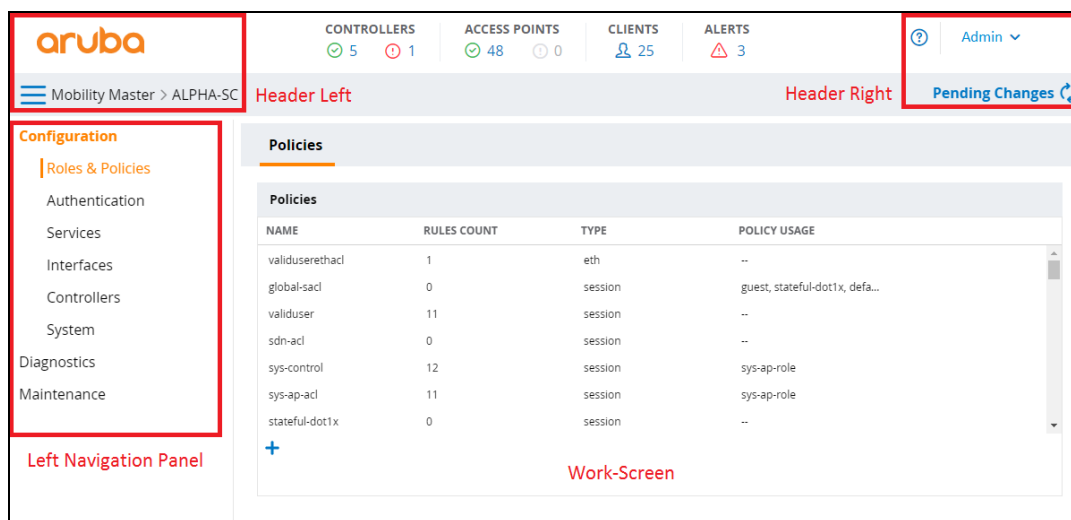
The Mobility Master user interface runs on a flat hierarchy profile design that provides ease-of-use through a simple navigation model.

## Navigation Model

Each page of the Mobility Master UI is divided into four sections:

- **Header-left:** Displays the Aruba logo and node-path. The node-path can be expanded to reveal the network hierarchy.
- **Header-right:** Contains the **Help (?)** button, user preference drop-down list, and **Pending Changes** button.
- **Left Navigation Panel:** Displays the main menu.
- **Work-screen:** Displays the content description for a menu item or tab.

**Figure 4** Overview of the User Interface

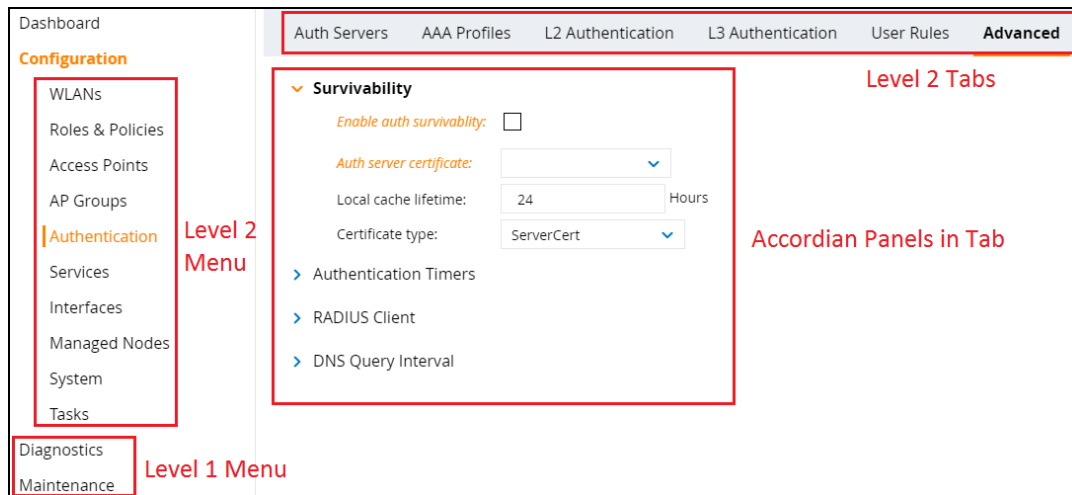


## Menu

The Mobility Master menu is divided into two levels: Level-1 (for example, Configuration, Diagnostics, and Maintenance) and Level-2 (for example, Authentication, Interfaces, and Services). Each Level-1 item can be expanded to display the corresponding Level-2 items. Each Level-2 item is further expanded to organize and group content on the work-screen. Based on the following dependencies, certain menu, tab, or accordion items may be visible or hidden in the UI:

- Selected node
- License
- Model
- Switch/User Role

**Figure 5** The WebUI Menu, Tabs, and Accordion Panels

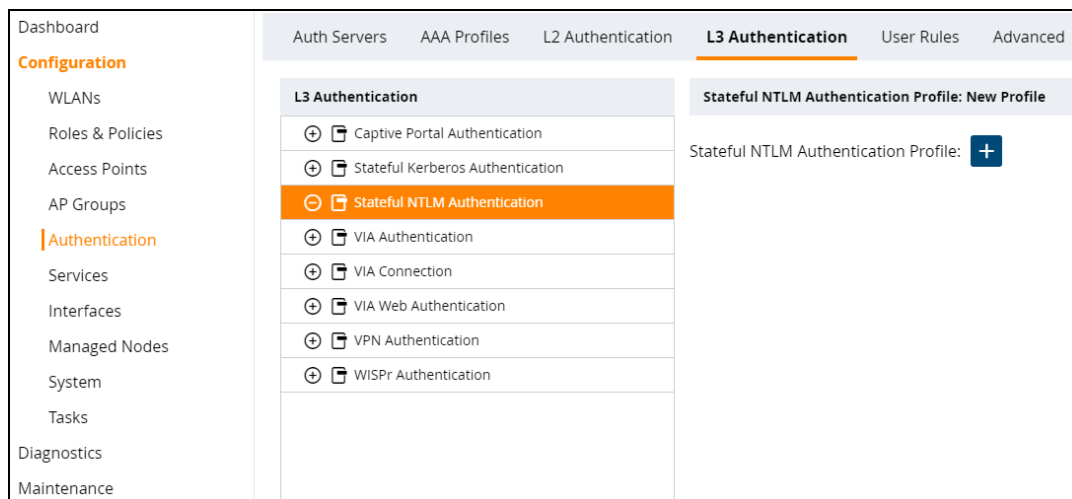


## Profile Configuration Interface

The profile configuration model is based off a single-page, flat hierarchy architecture, in which only a portion of the page is updated based on the action performed. The left-navigation panel, headers, and footer remain constant throughout all changes and selections, while only the work-screen is updated based on the menu, tab, and profile selections.

When a user selects a profile from the work-screen, the individual profile is expanded to display the configuration information. The complete list of profiles remains visible so that the user can display or minimize a profile at any time.

**Figure 6** Profile Configuration in the WebUI



## Tables

Mobility Master presents data and configuration information through two types of tables: primary tables and secondary tables. Primary tables display the main object of the page at the top of the screen (for example, the **Server Groups** table under **Configuration > Authentication > Auth Servers**). By selecting a row from the table, you can view and/or modify the configuration parameters for that entry in an editing pane that is displayed at the bottom of the screen.

The secondary table is located within the editing pane of a selected row and provides more in-depth information on each entry. For example, when you select the **default** server group entry from the **Server Groups** (primary) table, the secondary **Server Group > default** table is displayed at the bottom of the screen.

## Pending Changes

Commands are executed when a user clicks **Save** or **Submit**. The **Save** or **Submit** buttons are disabled by default and can only be enabled when the user modifies a configuration on the page. When a user clicks the **Save** or **Submit** button, the configuration change is pushed to the **Pending Changes** zone of Mobility Master. Modifications are not applied to the network until all pending changes are deployed. Click **Pending Changes** in the header-right section of the UI to view and deploy/discard all pending modifications.

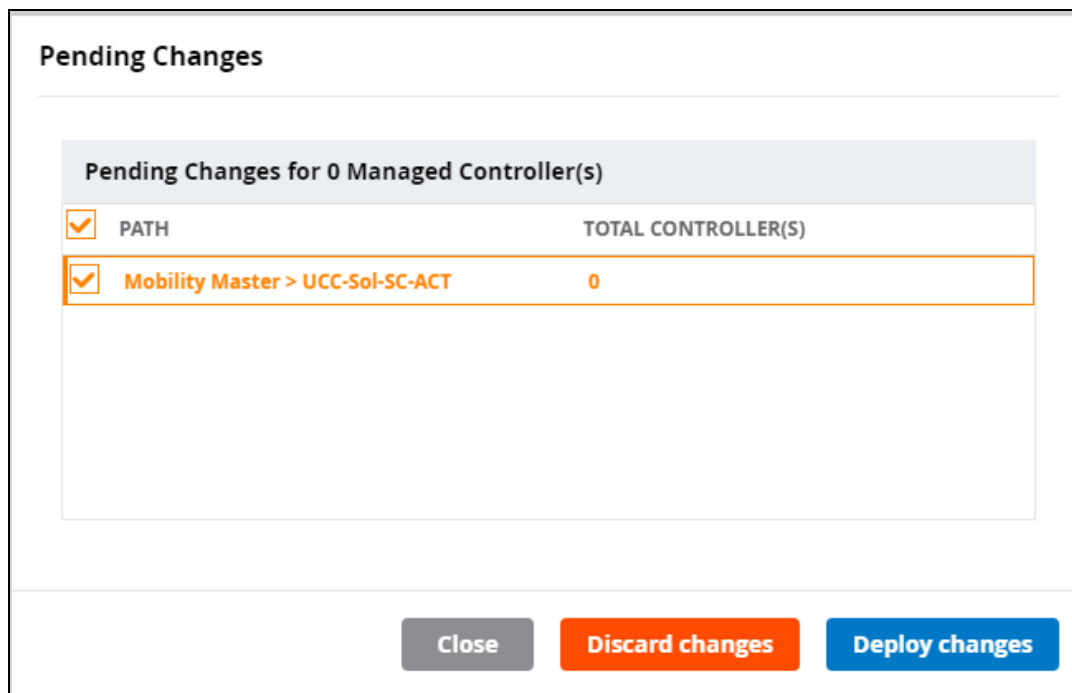


---

Nodes cannot be edited if any parent or child node contains undeployed pending changes.

---

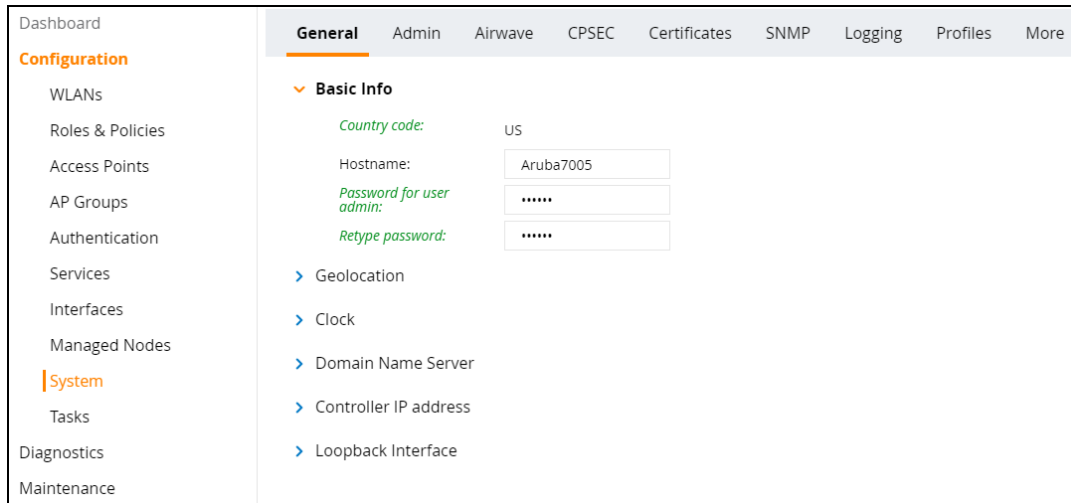
**Figure 7** Pending Changes Window



## Help Mode

The **Help (?)** button in the header-right section of the UI allows you to switch the system to help mode. All non-active labels that appear in green italics indicates that help information is available for these labels. Mouseover or click any green italic label to view the help information for that field in a pop-up window.

**Figure 8** Help Mode in the WebUI



## Hierarchy Management

The Mobility Master UI allows users to create, modify, and delete all hierarchical nodes from a central location. By clicking the node-path at the header-left section of the UI, you can reveal the entire network hierarchy. Click a node to further expand the hierarchy and display its child nodes.

When a node is selected from the network hierarchy, users are directed to the corresponding configuration profile. Any configuration changes made across the UI are executed and applied to the selected node.

For more information on the configuration hierarchy, see [Mobility Master Configuration Hierarchy on page 38](#).



This chapter describes how to connect a managed device and an Aruba AP to your wired network. After completing the tasks described in this chapter, see [Access Points on page 496](#) for information on configuring APs.

This chapter describes the following topics:

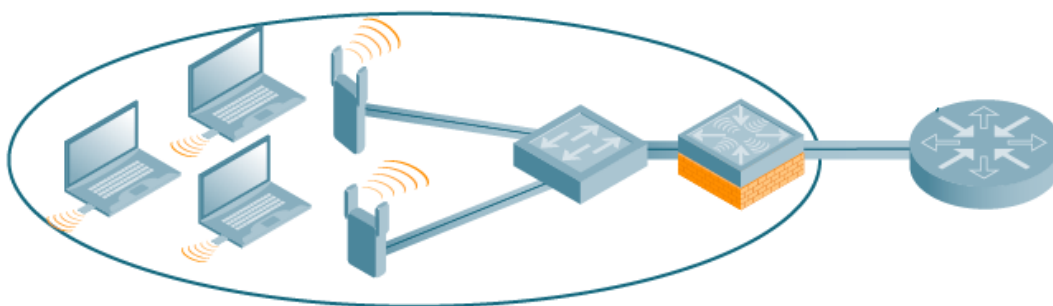
- [Understanding Basic Deployment and Configuration Tasks on page 57](#)
- [Managed Devices Configuration Workflow on page 60](#)
- [Connect the Managed Device to the Network on page 61](#)
- [Using the LCD Screen on page 62](#)
- [Configuring a VLAN to Connect to the Network on page 65](#)
- [Enabling Wireless Connectivity on page 69](#)
- [Configuring Your User-Centric Network on page 69](#)
- [Replacing a Controller on page 69](#)

## Understanding Basic Deployment and Configuration Tasks

This section describes typical deployment scenarios and the tasks you must perform while connecting to a managed device and Aruba AP to your wired network. For details on performing the tasks mentioned in these scenarios, see other procedures within the **Basic User-Centric Networks** section of this document.

### Deployment Scenario #1: Managed Device and APs on Same Subnet

**Figure 9** *Managed Device and APs on Same Subnet*



In this deployment scenario, the APs and managed device are on the same subnetwork and will use IP addresses assigned to the subnetwork. The router is the default gateway for the managed device and clients. There are no routers between the APs and the managed device. APs can be physically connected directly to the managed device. The uplink port on the managed device is connected to a layer-2 switch or router.

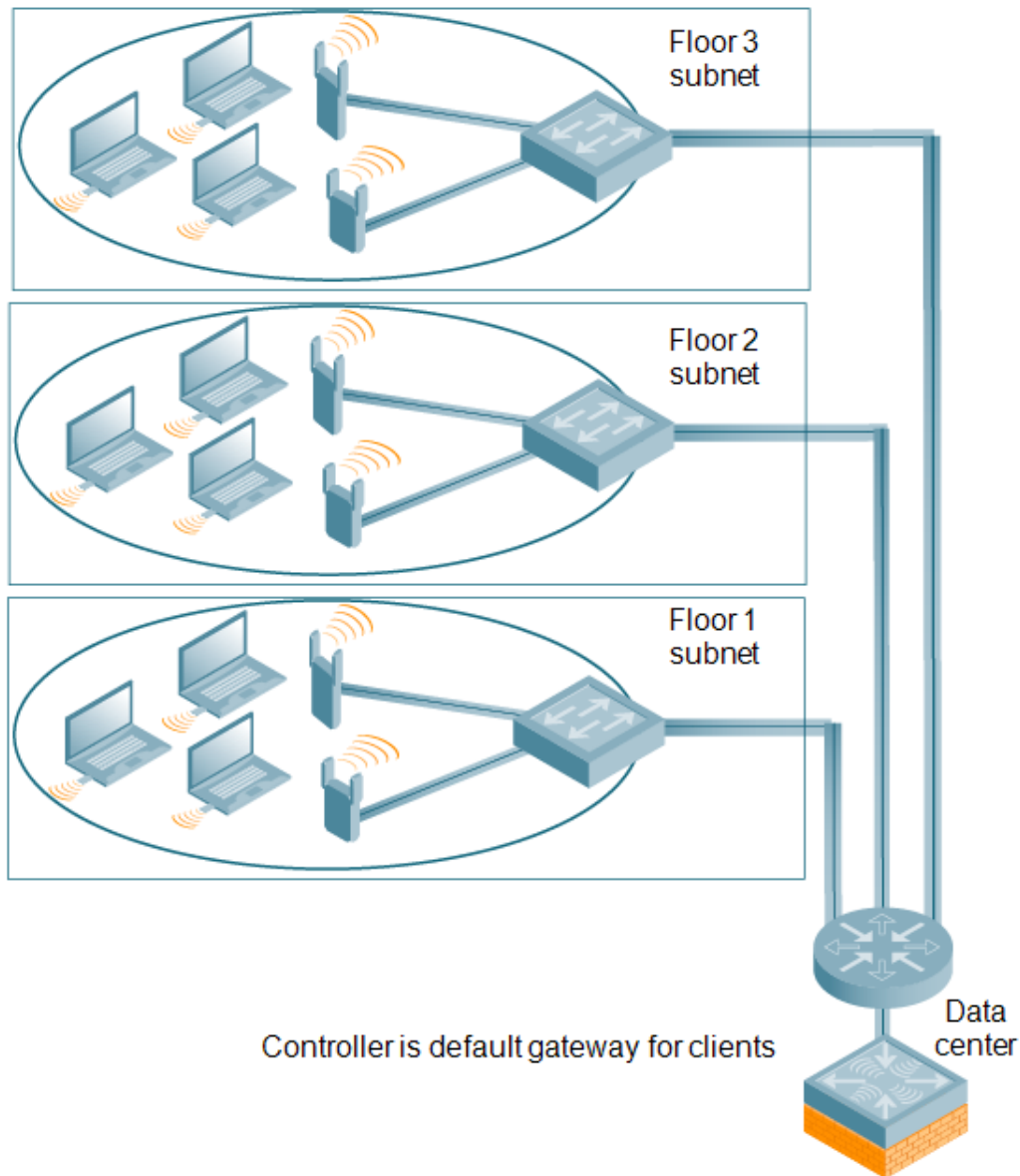
For this scenario, you must perform the following tasks:

1. Run the initial setup wizard.
  - Set the IP address of VLAN 1.
  - Set the default gateway to the IP address of the interface of the upstream router to which you will connect the managed device.

2. Connect the uplink port on the managed device to the switch or router interface. By default, all ports on the managed device are access ports and will carry traffic for a single VLAN.
3. Deploy APs. The APs will use the Aruba Discovery Protocol (ADP) to locate the managed device.
4. Configure the SSID(s) with VLAN 1 as the assigned VLAN for all users.

## Deployment Scenario #2: APs All on One Subnet Different from Managed Device Subnet

**Figure 10** APs All on One Subnet Different from Managed Device Subnets



In this deployment scenario, the APs and the managed device are on different subnetworks and the APs are on multiple subnetworks. The managed device acts as a router for the wireless subnetworks (the managed device is the default gateway for the wireless clients). The uplink port on the managed device is connected to a layer-2 switch or router; this port is an access port in VLAN 1.

For this scenario, you must perform the following tasks:

1. Run the initial setup wizard.

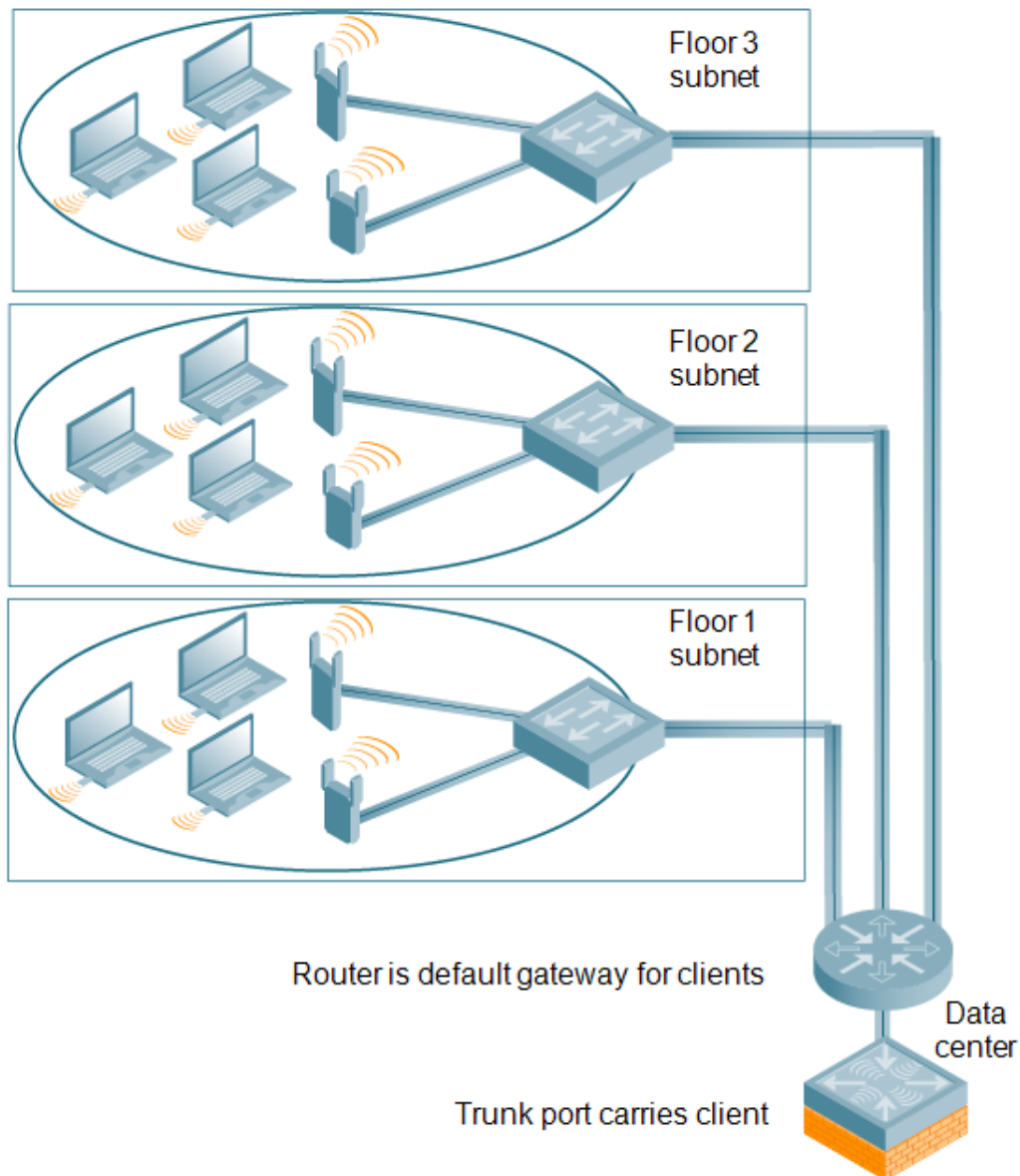
- Set the IP address for VLAN 1.
  - Set the default gateway to the IP address of the interface of the upstream router to which you will connect the managed device.
2. Connect the uplink port on the managed device to the switch or router interface.
  3. Deploy APs. The APs will use DNS or DHCP to locate the managed device.
  4. Configure VLANs for the wireless subnetworks on the managed device.
  5. Configure SSIDs with the VLANs assigned for each wireless subnetwork.



Each wireless client VLAN must be configured on the managed device with an IP address. On the uplink switch or router, you must configure static routes for each client VLAN, with the managed device's VLAN 1 IP address as the next hop.

## Deployment Scenario #3: APs on Multiple Different Subnets from Managed Devices

Figure 11 APs on Multiple Different Subnets from Managed Devices



In this deployment scenario, the APs and the managed device are on different subnetworks and the APs are on multiple subnetworks. There are routers between the APs and the managed device. The managed device is connected to a layer-2 switch or router through a trunk port that carries traffic for all wireless client VLANs. An upstream router functions as the default gateway for the wireless users.



---

This deployment scenario does *not* use VLAN 1 to connect to the layer-2 switch or router through the trunk port. The initial setup prompts you for the IP address and default gateway for VLAN 1; use the default values. In later steps, you configure the appropriate VLAN to connect to the switch or router as well as the default gateway.

---

For this scenario, you must perform the following tasks:

1. Run the initial setup.
  - Use the *default* IP address for VLAN 1. Since VLAN 1 is *not* used to connect to the layer-2 switch or router through the trunk port, you must configure the appropriate VLAN in a later step.
  - Do *not* specify a default gateway (use the default “none”). In a later step, you configure the default gateway.
2. Create a VLAN that has the same VLAN ID as the VLAN on the switch or router to which you will connect the managed device. Add the uplink port on the managed device to this VLAN and configure the port as a trunk port.
3. Add client VLANs to the trunk port.
4. Configure the default gateway on the managed device. This gateway is the IP address of the router to which you will connect the managed device.
5. Configure the loopback interface for the managed device.
6. Connect the uplink port on the managed device to the switch or router interface.
7. Deploy APs. The APs will use DNS or DHCP to locate the managed device.
8. Now configure VLANs on the managed device for the wireless client subnetworks and configure SSIDs with the VLANs assigned for each wireless subnetwork.

## Managed Devices Configuration Workflow

The tasks in deploying a basic user-centric network fall into two main areas:

- Configuring and connecting the managed device to the wired network (described in this section)
- Deploying APs (described later in this section)

The following workflow lists the tasks to configure a managed device. Click any of the links below for details on the configuration procedures for that task.

1. [Connect the Managed Device to the Network.](#)
2. [Setting System Clock.](#)
3. View current licenses and install new licenses.
4. For topologies similar to [Deployment Scenario #3: APs on Multiple Different Subnets from Managed Devices](#)), see [Configuring VLANs](#) to connect the managed device to your network. You do *not* need to perform this step if you are using VLAN 1 to connect the managed device to the wired network.
5. [Configuring the Mobility Master IP Address.](#) The managed device IP address is used by the managed device to communicate with external devices such as APs.
6. (Optional) [Configuring the Loopback IP Address.](#) You do *not* need to perform this step if you are using the VLAN 1 IP address as the managed device’s IP address. Disable spanning tree on the managed device if necessary.

7. [Configuring the Default Gateway](#) for this managed device if you need to configure a trunk port between the managed device and another layer-2 switch (shown in [Deployment Scenario #3: APs on Multiple Different Subnets from Managed Devices on page 59](#)).
8. [Trusted Vs. Untrusted Ports and VLANs](#) for this managed device.

## Connect the Managed Device to the Network

To connect the managed device to the wired network, run the initial setup to configure administrative information for the managed device.

Initial setup can be done using the browser-based Setup Wizard or by accessing the initial setup dialog via a serial port connection. Both methods are described in the *ArubaOS 8.0.1.0 Quick Start Guide* and are referred to throughout this *chapter* as “initial setup.”

This section describes the steps in detail.

### Running Initial Setup

When you connect to the managed device for the first time using either a serial console or a Web browser, the initial setup requires you to set the role (master, managed device, or stand-alone) for the managed device and passwords for administrator and configuration access.



---

Do not connect the managed device to your network when running the initial setup. The factory-default managed device boots up with a default IP address and both DHCP server and spanning tree functions are not enabled. Once you have completed the initial setup, you can use either the CLI or WebUI for further configuration before connecting the managed device to your network.

---

The initial setup might require that you specify the country code for the country in which the managed device will operate; this sets the regulatory domain for the radio frequencies that the APs use.



---

You cannot change the country code for managed device designated for certain countries, such as the U.S. Improper country code assignment can disrupt wireless transmissions. Many countries impose penalties and sanctions for operators of wireless networks with devices set to improper country codes. If none of the channels supported by the AP you are provisioning have received regulatory approval by the country whose country code you selected, the AP will revert to Air Monitor mode.

---

The initial setup requires that you configure an IP address for the VLAN 1 interface, which you can use to access and configure the managed device remotely via an SSH or WebUI session. Configuring an IP address for the VLAN 1 interface ensures that there is an IP address and default gateway assigned to the managed device upon completion of the initial setup.

### Connecting to the Managed Device after Initial Setup

After you complete the initial setup, the managed device reboots using the new configuration. (Refer to the *ArubaOS 8.0.1.0 Quick Start Guide* for information about using the initial setup.) You can then connect to and configure the managed device in several ways using the administrator password you entered during the initial setup:

- You can continue to use the connection to the serial port on the managed device to enter the command line interface (CLI). (See [Management Access on page 760](#) for information on how to access the CLI and enter configuration commands.)
- You can connect an Ethernet cable from a PC to an Ethernet port on the managed device. You can then use one of the following access methods:
  - Use the VLAN 1 IP address to start an SSH session where you can enter CLI commands.

- Enter the VLAN 1 IP address in a browser window to start the WebUI.
- WebUI Wizards.



This chapter and the user guide in general focus on CLI and standard WebUI configuration examples. However, basic managed device configuration and WLAN/LAN creation can be completed using the alternative tasks (wizards) from within the WebUI. If you wish to use a configuration task, in the **Managed Network** node hierarchy, navigate to **Configuration > Tasks**, click the desired task, and follow the imbedded help instructions within the task.

## 7200 Series Controllers Port Behavior

The first two ports on the 7200 Series controllers, 0/0/0 and 0/0/1, are dual media ports and can be used for any purpose. Ports 0/0/2 through 0/0/5 are fiber-based ports that can be used for any purpose. If the fiber-based ports are connected with RJ45 or Small Form-factor Pluggable (SFP) transceivers, these ports can function as 1 Gbps ports. To access the controller, you can use port 0/0/0 to 0/0/5 when 0/0/2 through 0/0/5 are connected with RJ45 or SFP transceivers.

The following table describes the connector and speed supported for each physical interface of the 7200 Series controllers.

**Table 13:** 7200 Series Controllers Ports

Port Type	Ports	Connector Type	Speed
10/100/1000 BASE-T Dual Media Ports	0/0/0-0/0/1	RJ45 or SFP	1 Gbps
10G BASE-X	0/0/2-0/0/5	SFP+	10 Gbps
		RJ45 or SFP	1 Gbps

## Using the LCD Screen

Some managed devices are equipped with an LCD panel that displays a variety of information about the managed device's status and provides a menu that allows for basic operations such as initial setup and reboot. The LCD panel displays two lines of text with a maximum of 16 characters on each line. When using the LCD panel, the active line is indicated by an arrow next to the first letter.

The LCD panel is operated using the two navigation buttons to the left of the screen.

- Menu: Allows you to navigate through the menus of the LCD panel.
- Enter: Confirms and executes the action currently displayed on the LCD panel.

The LCD has four modes:

- Boot: Displays the boot up status.
- LED Mode: Displays the mode that the STATUS LED is in.
- Status: Displays the status of different components of the managed device, including Power Supplies and ArubaOS version.
- Maintenance: Allows you to execute some basic operations of the managed device such as uploading an image or rebooting the system.

**Table 14: LCD Panel Mode: Boot**

Function/Menu Options	Displays
Displays boot status	"Booting ArubaOS..."

**Table 15: LCD Panel Mode: LED Mode**

Function/Menu Options	Displays
Administrative	LED MODE: ADM - displays whether the port is administratively enabled or disabled.
Duplex	LED MODE: DPX - displays the duplex mode of the port.
Speed	LED MODE: SPD - displays the speed of the port.
Exit Idle Mode	EXIT IDLE MENU

**Table 16: LCD Panel Mode: Status**

Function/Menu Options	Display Output
ArubaOS	Version ArubaOS X.X.X.X
PSU	Status Displays status of the power supply unit. <b>PSU 0: [OK   FAILED   MISSING]</b> <b>PSU 1: [OK   FAILED   MISSING]</b>
Fan Tray	Displays fan tray status. <b>FAN STATUS: [OK   ERROR   MISSING]</b> <b>FAN TEMP: [OK   HIGH   SHUTDOWN]</b>
Exit Status Menu	EXIT STATUS

**Table 17: LCD Panel Mode: Maintenance**

Function/Menu Options	Display Output
Upgrade Image	Upgrade the software image on the selected partition from a predefined location on the attached USB flash device. <b>Partition [0   1] Upgrade Image [no   yes]</b>
Upload Config	Uploads the managed device's current configuration to a predefined location on the attached USB flash device. <b>Upload Config [no   yes]</b>
Factory Default	Allows you to return the managed device to the factory default settings. <b>Factory Default [no   yes]</b>

Function/Menu Options	Display Output
Media Eject	Completes the reading or writing of the attached USB device. <b>Media Eject [no   yes]</b>
System Reboot	Allows you to reboot the managed device. <b>Reboot [no   yes]</b>
System Halt	Allows you to halt the managed device. <b>Halt [no   yes]</b>
Exit Maintenance Menu	EXIT MAINTENANCE

## Using the LCD and USB Drive

You can upgrade your image or upload a saved configuration by using your USB drive and your LCD commands.



For more information on copying and transferring ArubaOS image and configuration files, see [Managing Files on Managed Device on page 804](#)

## Upgrading an Image

1. Copy a new managed device image onto your USB drive into a directory named **/Arubaimage**.
2. Insert your USB drive into the managed device's USB slot. Wait for 30 seconds for the managed device to mount the USB.
3. Navigate to **Upgrade Image** in the LCD's **Maintenance** menu. Select a partition and confirm the upgrade (Y/N) and then wait for managed device to copy the image from the USB drive to the system partition.
4. Execute a system reboot either from the LCD menu or from the command line to complete the upgrade.

## Uploading a Saved Configuration

1. Make a copy of a managed device configuration (with the .cfg file extension), and save the copied file with the name **Aruba\_usb.cfg**.
2. Move the saved configuration file onto your USB drive into a directory named **/Arubaimage**.
3. Insert your USB drive into the managed device's USB slot. Wait for 30 seconds for the managed device to mount the USB.
4. Navigate to **Upload Config** in the LCD's **Maintenance** menu. Confirm the upload (Y/N) and then wait for the upload to complete.
5. Execute a system reboot either from the LCD menu or from the command line to reload from the uploaded configuration.

For detailed upgrade and instruction, refer to the Upgrade chapter in the *ArubaOS 8.0.1.0 Release Notes*.

## Disabling LCD Menu Functions

For security purposes, you can disable all LCD menu functions by disabling the entire menu functionality using the following commands:

```
(host) [md] (config) #lcd-menu
(host) [md] (lcd-menu) #disable menu
```



To prevent inadvertent menu changes, you can disable individual LCD menu functions using the following commands:

```
(host) [md] (lcd-menu) #disable menu maintenance ?
factory-default          Disable factory defaulting via LCD
halt-system              Disable system halt from LCD
media-eject              Disable media eject via LCD
reload-system            Disable system reload from LCD
upgrade-image            Disable image upgrade via LCD
upload-config            Disable config upload via LCD
```

To display the current LCD functionality from the command line, use the following command:

```
(host) [md] #show lcd-menu
```

## Configuring a VLAN to Connect to the Network

You must follow the instructions in this section only if you need to configure a trunk port between the managed device and another layer-2 switch (shown in [Deployment Scenario #3: APs on Multiple Different Subnets from Managed Devices on page 59](#)).

This section shows how to use both the WebUI and CLI for the following configurations (subsequent steps show how to use the WebUI only):

- Create a VLAN on the managed device and assign it an IP address.
- Optionally, create a VLAN pool. A VLAN pool consists of two more VLAN IDs which are grouped together to efficiently manage multi-managed device networks from a single location. For example, policies and virtual application configurations map users to different VLANs which may exist at different managed device. This creates redundancy where one managed device has to back up many other managed devices. With the VLAN pool feature you can control your configuration globally.



---

VLAN pooling should *not* be used with static IP addresses.

---

- Assign to the VLAN the ports that you will use to connect the managed device to the network. (For example, the uplink ports connected to a router are usually Gigabit ports.) In the example configurations shown in this section, a managed device is connected to the network through its Gigabit Ethernet port 1/25.
- Configure the port as a trunk port.
- Configure a default gateway for the managed device.

## Creating, Updating, and Viewing VLANs and Associated IDs

You can create and update a single VLAN or bulk VLANs using the WebUI or the CLI. See [Creating and Updating VLANs on page 89](#).



---

In the WebUI configuration windows, clicking the **Pending Changes** button saves configuration changes so that they are retained after the managed device is rebooted. Clicking the **Submit** or **Apply** button saves changes to the running configuration but the changes are not retained when the managed device is rebooted. A good practice is to use the **Submit** or **Apply** button to save changes to the running configuration and, after ensuring that the system operates as desired, click **Pending Changes**.

---

You can view VLAN IDs in the CLI.

```
(host) [mynode] #show vlan
```

## Creating, Updating, and Deleting VLAN Pools



---

VLAN pooling should *not* be used with static IP addresses.

---

You can create, update, and delete a VLAN pool using the WebUI or the CLI. See [Creating a Named VLAN on page 90](#).

Use the CLI to add existing VLAN IDS to a pool.

```
(host) [mynode] (config) #vlan-name <name>
(host) [mynode] (config) #vlan mygroup <vlan-ids>
```

To confirm the VLAN pool status and mappings assignments, use the **show vlan mapping** command:

```
(host) [mynode] #show vlan mapping
```

### Assigning and Configuring the Trunk Port

The following procedures configures a Gigabit Ethernet port as trunk port.

#### In the WebUI

To configure a Gigabit Ethernet port:

1. In the **Managed Network** node hierarchy, navigate to **Configuration > Interfaces > Ports**.
2. In the **Ports** section, click the port that will connect the managed device to the network.
3. Select **Trunk** from the **Mode** drop-down list.
4. Select a VLAN from the **Native VLAN** drop-down list.
5. Click **Submit**.
6. At the top of the window, click **Pending Changes**.
7. In the **Pending Changes** window, select the check box indicating the pending change and click **Deploy Changes**.

#### In the CLI

To configure a Gigabit Ethernet port:

```
(host) [mynode] (config) #interface gigabitethernet <slot>/<module>/<port>
(host) [mynode] (config-submode) #switchport mode trunk
(host) [mynode] (config-submode) #switchport trunk native vlan <id>
```

To confirm the port assignments, use the **show vlan** command:

```
(host) [mynode] #show vlan
```

### Configuring the Default Gateway

The following configurations assign a default gateway for the managed device.

#### In the WebUI

To configure the default gateway:

1. In the **Managed Network** node hierarchy, navigate to **Configuration > Interfaces > IP Routes**.
2. Click the **Static Default Gateway** accordion menu.
3. To add a new static gateway, click the **Add** button below the static IP address list.
  - a. Select **IPv4** from the **IP version** drop-down list.
  - b. In the **IP Address** field, enter an IP address with dot separators.
  - c. In the **Cost** field, enter a value for the path cost.

- d. Click **Submit**.
4. You can define a dynamic gateway with the DHCP, PPPOE, or Cellular option by clicking the **Dynamic Default Gateway** accordion menu.
  - a. In the **Dynamic Default Gateway** section, select **Enabled** for the **DHCP, PPPoE** or **Cellular** drop-down list. If you enabled more than one dynamic gateway type, you must also define the cost for each gateway route. The managed device will first attempt to obtain a gateway IP address using the option with the lowest cost. If the managed device is unable to obtain a gateway IP address, it will then attempt to obtain a gateway IP address using the option with the next-lowest path cost.
  - b. Click **Submit**.
5. At the top of the window, click **Pending Changes**.
6. In the **Pending Changes** window, select the check box indicating the pending change and click **Deploy Changes**.

## In the CLI

To configure the default gateway:

```
(host) [mynode] (config) #ip default-gateway <ipaddr>|{import cell|dhcp|pppoe}|{ipsec <name>}<br><cost> | mgmt | <nexthop>
```

## Configuring the Loopback IP Address for the Managed Device

You must configure a loopback address if you are not using a VLAN ID address to connect the managed device to the network (see [Deployment Scenario #3: APs on Multiple Different Subnets from Managed Devices on page 59](#)).



---

After you configure or modify a loopback address, you must reboot the managed device.

---

If configured, the loopback address is used as the managed device's IP address. If you do not configure a loopback address for the managed device, the IP address assigned to the first configured VLAN interface IP address is considered. Generally, VLAN 1 is configured first and is used as the managed device's IP address. ArubaOS allows the loopback address to be part of the IP address space assigned to a VLAN interface. For example, if VLAN 5 interface on the managed device was configured with the IP address 10.3.22.20/24, the loopback IP address can be configured as 10.3.22.220.



---

You configure the loopback address as a host address with a 32-bit netmask. The loopback address should be routable from all external networks.

---

Spanning tree protocol (STP) is enabled by default on the managed device. STP ensures a single active path between any two network nodes, thus avoiding bridge loops. Disable STP on the managed device if you are not employing STP in your network.

## In the WebUI

To configure a loopback IP address:

1. In the **Managed Network** node hierarchy, navigate to **Configuration > System > General**.
2. Click the **Loopback Interface** accordion menu.
3. Enter the IPv4 address and/or the IPv6 address in the corresponding text boxes.
4. Click **Submit**.
5. In the **Managed Network** node hierarchy, navigate to **Configuration > System > More**.

6. In **Spanning Tree**, you can turn off the spanning tree option by selecting **Disabled** from the **Spanning Tree** drop-down list.
7. Click **Submit**.
8. At the top of the window, click **Pending Changes**.
9. In the **Pending Changes** window, select the check box indicating the pending change and click **Deploy Changes**.



---

You must reboot the managed device for the new IP address to take effect.

---

10. In the **Mobility Master** node hierarchy, navigate to **Maintenance > Software Management > Reboot**.
11. Select **Yes** for **Save Current Configuration Before Reboot**.
12. Click **Reboot**.

### In the CLI

To configure a loopback IP address:

```
(host) [mynode] (config) #interface loopback ip address <A.B.C.D>
(host) [mynode] (config) #no spanning-tree
(host) [mynode] (config) #write memory
(host) [mynode] (config) #reload
```

The managed device returns the following messages:

```
Do you really want to reset the system(y/n):
```

Enter **y** to reboot the managed device or **n** to cancel.

```
System will now restart!
```

```
...
```

```
Restarting system.
```

To verify that the managed device is accessible on the network, ping the loopback address from a workstation on the network.

## Configuring the System Clock

You can manually set the clock on the managed device, or configure the managed device to use a Network Time Protocol (NTP) server to synchronize its system clock with a central time source. For more information about setting the managed device's clock, see [Setting System Clock on page 807](#).

## Installing Licenses

For information on licenses installation, refer to the *Aruba Mobility Master Licensing Guide*.

## Connecting the Managed Device to the Network

Connect the ports on the managed device to the appropriately-configured ports on an L2 switch or router. Make sure that you have the correct cables and that the port LEDs indicate proper connections. Refer to the *Aruba Mobility Master and VMC Installation Guide* for details on the managed device for port LED and cable descriptions.



---

In many deployment scenarios, an external firewall is situated between various Aruba devices. [External Firewall Configuration on page 626](#) describes the network ports that must be configured on the external firewall to allow proper operation of the network.

---

To verify that the managed device is accessible on the network:

- If you are using VLAN 1 to connect the managed device to the network ([Deployment Scenario #2: APs All on One Subnet Different from Managed Device Subnet on page 58](#) and [Deployment Scenario #3: APs on Multiple Different Subnets from Managed Devices on page 59](#)), ping the VLAN 1 IP address from a workstation on the network.
- If you created and configured a new VLAN ([Deployment Scenario #3: APs on Multiple Different Subnets from Managed Devices on page 59](#)), ping the IP address of the new VLAN from a workstation on the network.

## Enabling Wireless Connectivity

Wireless users can connect to the SSID but because you have not yet configured authentication, policies, or user roles, they will not have access to the network. Other chapters in the *ArubaOS 8.0.1.0 User Guide* describe how to build upon this basic deployment to configure user roles, firewall policies, authentication, authentication servers, and other wireless features.

## Configuring Your User-Centric Network

Configuring your managed device and AP is done through either the Web User Interface (WebUI) or the command line interface (CLI).

- WebUI is accessible through a standard Web browser from a remote management console or workstation. The WebUI includes configuration tasks that walk you through easy-to-follow configuration steps. Each task has embedded online help. The tasks are:
  - Provision New APs—basic AP configurations including LAN, Remote, LAN Mesh, and Remote Mesh deployment scenarios.
  - Controller—applicable only the first time the managed device is brought UP; basic managed device configuration including system settings, Control Plane security, and cluster settings
  - Create a New WLAN—creating and configuring new WLANs and LANs associated with the “default” ap-group. Includes campus-only and remote networking.




---

Clicking **Cancel** from the tasks (wizards) return you to where you launched the tasks from. Any configuration changes you entered are not saved.

---

- The command line interface (CLI) allows you to configure and manage managed device. The CLI is accessible from a local console connected to the serial port on the managed device or through a Telnet or Secure Shell (SSH) session from a remote management console or workstation.




---

By default, you can only access the CLI from the serial port or from an SSH session. To use the CLI in a Telnet session, you must explicitly enable Telnet on the managed device.

---

## Replacing a Controller

The procedures below describe the steps to replace an existing stand-alone controller and/or a redundant controller. Best practices are to replace the backup controller first, and replace the active controller only after the new backup controller is operational on the network. When you remove the active controller from the network to replace it, the new backup controller takes over the active controller role. When you add a second controller to the network, that second controller automatically assumes the role of a backup controller.

For information on the virtual mobility controller (VMC), refer to the *Aruba Mobility Master and VMC Installation Guide*.

## Replacing an RMA Device

If the controller being replaced was returned to Aruba as a Return Merchandize Authorization (RMA) device, the license keys on the RMA controller cannot be directly transferred to a new device, and must be regenerated.

To generate a new license key for a controller that is returned as an RMA:

1. Access the My Networking Portal (MNP) at <http://hpe.com/networking/mynetworking/>.
2. Log in to MNP using the HPE Passport.
3. Click **View licenses** or **Transfer licenses to new platform**. All available licenses are displayed.
4. Select the >> icon at the right end of the record to verify the license details before transferring it.
5. Click **Transfer License** at the bottom of the page.
6. Select a controller from the **AOS Controller Type** drop-down list.
7. Enter the serial number of the mobility controller in the **Serial number** text box; or enter the passphrase of the Mobility Master in the **PassPhrase** text box.
8. Select the license to be transferred.
9. Click **Transfer** at the bottom of the page. A new license key is generated, which you can apply to the controller.

## Procedure Overview

The procedure to replace a backup or active controller consists of the following tasks:

1. [Step 1: \(Optional\) Change the VRRP Priorities for a Redundant Master Pair on page 70](#)
2. [Step 2: Back Up the Flash File System on page 70](#)
3. [Step 3: Stage the New Controller on page 71](#)
4. [Step 4: Add Licenses to the New Controller on page 71](#)
5. [Step 5: Backup Newly Installed Licenses on page 71](#)
6. [Step 6: Import and Restore the Flash Backup on page 71](#)
7. [Step 7: Restore Licenses on page 72](#)
8. [Step 8: Reboot the Controller on page 72](#)
9. [Step 9. \(Optional\) Modify the Host Name on page 72](#)
10. [Step 10: Save your Configuration on page 73](#)
11. [Step 11: Remove the Existing Controller on page 73](#)



---

If your controller does not have any manually added licenses, skip steps 3, 4, and 6 of the following procedure.

---

### Step 1: (Optional) Change the VRRP Priorities for a Redundant Master Pair

If your deployment uses VRRP to define the primary Mobility Master in a pair of redundant Mobility Masters, and you are replacing only the primary Mobility Master, and you must change the VRRP priority levels of the controllers so that the primary Mobility Master has a lower priority than the backup Mobility Master. This will allow the configuration from the backup Mobility Master to be copied to the new Mobility Master, and prevent an old or inaccurate configuration from being pushed to the managed devices.

### Step 2: Back Up the Flash File System

To start the migration process, access the backup controller or Mobility Master being replaced and create a backup of the flash file system. You can create a backup file using the WebUI or command-line interfaces.

To create a flash backup from the command-line interface, access the active controller and issue the **backup flash** command. To back up the flash from the WebUI, log in to the current backup controller or active controller and create a flash backup using the procedure below.

1. In the **Mobility Master > host** node hierarchy, navigate to **Maintenance > Configuration Management > Backup**.
2. Select Flash and **Create Backup**.
3. Select **Copy Backup** to create a copy of the backup file. By default, the flash backup file is named **flashbackup.tar.gz**.
4. Next, to move the backup of the flash file system to an external server, in the **Mobility Master > host** node hierarchy, navigate to **Diagnostics > Technical Support > Copy Files**.
5. In the **Source Selection** section, select **Flash File System**.
6. In the **Destination Selection** section, select one of the server options to move the flash backup off the controller, and enter the name of the flash backup file to be exported.
7. Click **Apply**.
8. The status of the copy operation is displayed under the **Destination Selection** section.

### Step 3: Stage the New Controller

The next step in the procedure is to stage the new backup controller or active controller with basic IP connectivity. Power up the new controller, connect a laptop computer to the controller's serial port, and follow the prompts to configure basic settings, such as the controller name, role, VLAN, gateway, country code, and time zone.

### Step 4: Add Licenses to the New Controller

To replace a controller with manually added licenses, you will need to transfer those licenses to the new controller as part of the replacement process.

Use the **license add** command in the command-line interface. Alternatively, in the **Mobility Master** node hierarchy, navigate to **Configuration > System > Licensing > Controller Licenses** to add new or transferred licenses to the new controller.



---

Do not reboot the controller at the end of this step. Do not save the configuration or write it to memory. Reboot only after the flash memory and the licenses have been restored.

---

### Step 5: Backup Newly Installed Licenses

Use the **license export** command in the command-line interface to back up the newly installed licenses to the backup license database.

```
(host) [mynode] #license export <filename>
```



---

Do **not** reboot the controller at the end of this step. Do not save the configuration or write it to memory. Reboot only after the flash memory and the licenses have been restored.

---

### Step 6: Import and Restore the Flash Backup

Import and restore the backup flash file system from the original controller to the new controller.



---

Do **not** reboot the controller at the end of this step. Do not save the configuration or write it to memory. Reboot only after the flash memory and the licenses have been restored.

---

To import and restore a flash backup using the WebUI:

1. Access the new controller.
2. In the **Mobility Master > host** node hierarchy, navigate to **Diagnostics > Technical Support > Copy Files**.
3. In the **Source Selection** section, select any of the source options, or select a method for uploading the file.
4. In the **Destination Selection** section, choose **Flash File System**.
5. Enter the filename of the flash backup and click **Apply**. By default, the flash backup file is named **flashbackup.tar.gz**.
6. Next, **Mobility Master > host** node hierarchy, navigate to **Maintenance > Configuration Management > Restore**.
7. Select **Flash** and click **Restore**.
8. The status of the copy operation is displayed under the **Destination Selection** section.

To import and restore a flash backup file using the command-line interface, use the **copy** and **restore flash** commands. The following example copies a backup file from a USB drive.

```
(host) [mynode] #copy usb: Partition 1 flashbak2_3600.tar.gz flash: flashbackup.tar.gz
...File flashbak2_3600.tar.gz copied to flash successfully.
(host) [mynode] #restore flash
```

## Step 7: Restore Licenses

Execute the **license import** command in the command-line interface to import licenses from the license database to the new controller.

```
(host) [mynode] #license import <filename>
```




---

Do not save the configuration or write to memory at the end of this step.

---

## Step 8: Reboot the Controller

When all the licenses have been restored, issue the **reload** command in the command-line interface. Alternatively, in the **Mobility Master** node, navigate to **Maintenance > Software Management > Reboot** in the WebUI to reboot the new controller. After rebooting, the controller should not be on the network (or a reachable subnet) with the controller it will replace. This is to prevent a possible IP address conflict.




---

Do **not** save the configuration or write to memory at the end of this step.

---

```
(host) [mynode] #reload
Do you want to save the configuration(y/n): n
Do you really want to restart the system(y/n): y
System will now restart!
```

## Step 9. (Optional) Modify the Host Name

Execute the **hostname** command in the command-line interface to give the new controller a unique host name. (The flash restoration process gives the new controller the same name as the existing controller.)




---

Do **not** save the configuration or write to memory at the end of this step.

---



## Step 10: Save your Configuration

Now, you must save the configuration settings on the new controller. Execute the **write memory** command in the command-line interface, or in the **Managed Network** node, click the **Configuration** tab and select **Pending Changes** at the top of the WebUI page.

## Step 11: Remove the Existing Controller

If you are only replacing a backup controller, remove the existing backup controller, then connect the replacement controller to the network. If you are replacing both an active controller and a backup controller, replace the backup controller first.

When the active controller is removed from the network, the backup controller immediately assumes the role of active controller, and all active APs associate to the new active controller within a few seconds. Therefore, when you add another controller to the network, it will, by default, assume the role of a backup controller.

If you changed the VRRP priorities of your redundant Mobility Master prior to replacing the primary Mobility Master, you may wish to change them back once the new primary Mobility Master is active on the network.

ArubaOS supports secure IPsec communications between a controller and campus or remote APs using public-key self-signed certificates created by each Mobility Master. The controller certifies its APs by issuing them certificates.

If the Mobility Master has any associated managed devices, the Mobility Master sends a certificate to each managed device, which in turn sends certificates to their own associated APs. If a managed device is unable to contact the Mobility Master to obtain its own certificate, it is not be able to certify its APs, and those APs can not communicate with their managed device until Mobility Master-managed device communication has been re-established. You create an initial control plane security configuration when you first configure the controller using the initial setup wizard. The ArubaOS initial setup wizard enables control plane security by default, so it is very important that the managed device be able to communicate with the Mobility Master when it is first provisioned.

Some AP model types have factory-installed digital certificates. These AP models use their factory-installed certificates for IPsec, and do not need a certificate from the controller. Once a campus or remote AP is certified, either through a factory-installed certificate or a certificate from the controller, the AP can failover between managed devices and still stay connected to the secure network, because each AP has the same Mobility Master as a common trust anchor.

The controller maintains two separate AP whitelists; one for campus APs and one for remote APs. These whitelists contain records of all campus APs or remote APs connected to the network. You can use a campus or remote AP whitelist at any time to add a new valid campus or remote AP to the secure network, or revoke network access to any suspected rogue or unauthorized APs.

When the controller sends a certificate to the AP, that AP must reboot before it can connect to its controller over a secure channel. If you are enabling control plane security for the first time on a large network, you may experience several minutes of interrupted connectivity while each AP receives its certificate and establishes its secure connection.

Topics in this chapter include:

- [Control Plane Security Overview on page 74](#)
- [Configuring Control Plane Security on page 75](#)
- [Managing AP Whitelists on page 76](#)
- [Whitelist DB Optimization on page 82](#)
- [Configuring Networks with a Backup Mobility Master on page 83](#)
- [Replacing a Controller on a Multi-Controller Network on page 83](#)
- [Troubleshooting Control Plane Security on page 84](#)

## Control Plane Security Overview

Controllers using control plane security send certificates to APs that you have identified as valid APs on the network. If you want closer control over each AP that is certified, you can manually add individual campus and remote APs to the secure network by adding each AP's information to the whitelists when you first run the initial setup wizard. If you are confident that all APs currently on your network are valid APs, then you can use the initial setup wizard to configure automatic certificate provisioning to send certificates from the controller to each campus or remote AP, or to all campus and remote APs within specific ranges of IP addresses.

The default automatic certificate provisioning setting requires that you manually enter each campus AP's information into the campus AP whitelist, and each remote AP's information into the remote AP whitelist. If you change the default automatic certificate provisioning values to let the controller send certificates to all APs on the network, all valid APs will receive certificate, but this also increases the chance that you will certify a rogue or unwanted AP. If you configure the controller to send certificates to only those APs within a range of IP addresses, there is a smaller chance that a rogue AP receives a certificate, but any valid AP with an IP address outside the specified address ranges will not receive a certificate, and cannot communicate with the controller (except to obtain a certificate). Consider both options carefully before you complete the control plane security portion of the initial setup wizard. If your controller has a publicly accessible interface, you should identify the APs on the network by the IP address range. This prevents the controller from sending certificates to external or rogue campus APs that may attempt to access your controller through that publicly accessible interface.

## Configuring Control Plane Security

When you initially deploy the controller, you create your initial control plane security configuration using the initial setup wizard. These settings can be changed at any time using the WebUI or the command-line interfaces.

### In the WebUI

1. In the **Managed Network** node hierarchy, navigate to **Configuration > System > CPSEC** tab.
2. Select the **Control Plane Security** accordion.
3. Select the **Enable CPSEC** check box.
4. Click **Submit**.
5. Click **Pending Changes**.
6. In the **Pending Changes** window, select the check box and click **Deploy changes**.

#### To enable auto cert provisioning:

1. In the **Managed Network** node hierarchy, navigate to **Configuration > System > CPSEC** tab.
2. Select the **Control Plane Security** accordion.
3. Select the **Enable CPSEC** check box.
4. Select the **Enable Auto Cert Provisioning** check box to allow AP's from specified ranges.
5. Select the **Only accept APs from specified ranges** check box.
  - a. Click + in **Address ranges for Auto Cert Provisioning** table. The **New Address Range** window is displayed.
  - b. Enter the ipv4/ipv6 address in the Start address (ipv4/ipv6) and End address (ipv4/ipv6) fields.
  - c. Click **OK**.
6. Click **Submit**.
7. Click **Pending Changes**.
8. In the **Pending Changes** window, select the check box and click **Deploy changes**.

The Mobility Master generates its self-signed certificate and begins distributing certificates to campus APs and any managed devices on the network over a clear channel. After all APs have received a certificate and have connected to the network using a secure channel, access the **Control Plane Security** window and turn off auto certificate provisioning if that feature was enabled. This prevents the controller from issuing a certificate to any rogue APs that may appear on your network at a later time.

## In the CLI

Use the commands below to configure control plane security via the command line interface on a managed device or Mobility Master.

```
(host) [md] (config) #control-plane-security
(host) [md] (Control Plane Security Profile) #auto-cert-allow-all
(host) [md] (Control Plane Security Profile) #auto-cert-allowed-addr <start> <end>
(host) [md] (Control Plane Security Profile) #auto-cert-prov
(host) [md] (Control Plane Security Profile) #cpsec-enable
```

View the current control plane security settings using the following command:

```
(host) [md] (config)#show control-plane-security
```

## Managing AP Whitelists

Campus or remote APs appear as valid APs in the campus or remote AP whitelists when you manually enter their information into the campus or remote AP whitelists through the WebUI or CLI of a controller or after a controller sends a certificate to an AP as part of automatic certificate provisioning and the AP connects to the controller over a secure tunnel. APs that are not approved or certified on the network are included in the campus AP whitelists, but these APs appear in an unapproved state.

Use the AP whitelists to grant valid APs secure access to the network or to revoke access from suspected rogue APs. When you revoke or remove an AP from the campus or remote AP whitelists on a controller that uses control plane security, that AP will not be able to communicate with the controller again, unless the AP obtains a new certificate.

### Adding an AP to the Campus or Remote AP Whitelists

You can add an AP to the campus AP or remote AP whitelists using the WebUI or CLI.

#### In the WebUI

To add an AP to the campus AP or remote AP whitelist:

1. In the **Managed Network** node hierarchy, navigate to the **Configuration > Access Points > Whitelist** tab.
2. Click **Campus AP Whitelist / Remote AP Whitelist** tab.
3. Click **+**.
4. Define the following parameters for each AP you want to add to the AP whitelist:

**Table 18:** AP Whitelist Parameters

Parameter	Description
<b>Campus AP whitelist configuration parameters</b>	
MAC address	MAC address of campus AP that supports secure communications to and from its controller.
AP name	Name of the campus AP. If you do not specify a name, the AP uses its MAC address as AP name.
AP group	Name of the AP group to which the campus AP is assigned. If you do not specify an AP group, the AP uses default as its AP group.

**Table 18: AP Whitelist Parameters**

Parameter	Description
Description	Brief description of the campus AP.
<b>Remote AP whitelist configuration parameters</b>	
MAC address	MAC address of the remote AP, in colon-separated octets.
AP name	Name of the Remote AP. If you do not specify a name, the AP uses its MAC address as AP name.
AP group	Name of the AP group to which the Remote AP is assigned.
Description	Brief description of the Remote AP.

5. Click **Submit**.
6. Click **Pending Changes**.
7. In the **Pending Changes** window, select the check box and click **Deploy changes**.

### In the CLI

To add an AP to the campus AP whitelist:

```
(host) [mynode] (config) #whitelist-db cpsec add mac-address <address>
  ap-group <ap_group>
  ap-name <ap_name>
  description <description>
```

To add an AP to the remote AP whitelist:

```
(host) [mynode] (config) #whitelist-db rap add mac-address <mac-address>
  ap-group <ap-group>
  ap-name <ap-name>
  description <description>
  full-name <name>
  remote-ip <inner-ip-adr>
  remote-ipv6 <ipv6 address>
```

### Viewing AP Whitelist Entries

The WebUI displays the table of entries in the selected AP whitelist. The table of entries page displays a list of AP whitelist entries.

The **Configuration > Access Points > Whitelist** tab displays the list of the campus AP whitelists by default. To view the list of remote AP whitelists, click **Remote AP whitelist**.

The remote AP whitelist entries page displays only the information you can manually configure. The campus AP whitelist entries page displays both user-defined settings and additional information that is updated when the status of a campus AP changes.

**Table 19: Campus AP Parameters**

Parameter	Description
Status	Displays the status of the AP whitelist entry.
Revoke	Shows if the secure status of the AP is revoked.
Revoke text	Brief description for revoking the campus AP.
Updated	Time and date of the last AP status update.

To view information about the campus and remote AP whitelists using the CLI, use the following commands:

```
(host) [mynode] #show whitelist-db cpsec
Control-Plane Security Whitelist-entry Details
```

```
-----
MAC-Address      AP-Group  AP-Name  Enable  State  Cert-Type
Description  Revoke Text  Last Updated
-----
-----
6c:f3:7f:cc:42:25          Enabled  certified-factory-cert  factory-cert
      Thu Jul  7 03:42:21 2016
9c:1c:12:c0:7c:a6 default  san225  Enabled  certified-factory-cert  factory-cert
      Wed Aug  3 10:34:13 2016
24:de:c6:ca:94:ba          Enabled  certified-factory-cert  factory-cert
      Fri Apr 22 06:28:46 2016
94:b4:0f:c0:cc:42          Enabled  certified-factory-cert  factory-cert
      Fri Aug  5 06:54:43 2016
18:64:72:cf:e6:9c          Enabled  certified-factory-cert  factory-cert
      Tue Aug  9 07:35:41 2016
ac:a3:1e:c0:e6:82          Enabled  certified-factory-cert  factory-cert
      Wed Aug 10 09:12:23 2016
ac:a3:1e:cd:36:84          Enabled  certified-factory-cert  factory-cert
      Fri Jun 17 05:50:02 2016
ac:a3:1e:c0:e6:9a          Enabled  certified-factory-cert  factory-cert
      Thu May 26 06:31:13 2016
Total Entries: 8
```

```
(host) [mynode] #show whitelist-db cpsec-status
My Mac-Address      00:1a:1e:00:1a:b8
My IP-Address       10.15.28.16
Master IP-Address   10.15.28.16
Switch-Role        Master
Whitelist-sync is disabled
Entries in Whitelist database
Total entries:      5
Approved entries:   0
Unapproved entries: 2
Certified entries:  2
Certified hold entries: 1
Revoked entries:    0
Marked for deletion entries: 0
Current Sequence Number: 147
```

```
(host) [mynode] #show whitelist-db rap
Entries in Whitelist database
Total entries:      0
Revoked entries:    0
Marked for deletion entries: 0
```

## Modifying an AP in the Campus AP Whitelist

Use the following procedures to modify the AP group, AP name, certificate type, state, description, and revoked status of an AP in the campus AP whitelist.

### In the WebUI

To modify an AP in the campus AP whitelist:

1. In the **Managed Network** node hierarchy, navigate to the **Configuration > Access Points > Whitelist** tab.
2. Click **Campus AP Whitelist** tab.
3. Select the check box of the AP that you want to modify.
4. Modify the settings of the selected AP. Some of the following parameters are available when adding an AP to the campus AP whitelist.
  - **AP Group:** The name of the AP group to which the campus AP is assigned.
  - **AP Name:** The name of the campus AP. If you not specify a name, the AP uses its MAC address as a name.
  - **Description:** Brief description of the campus AP.
  - **Revoke:** Click the **Revoke** check box to revoke an invalid or rogue AP.
  - **Revoke Text:** Enter a brief comment describing why the AP is being revoked.
5. Click **Submit** to update the campus AP whitelist entry with its new settings.
6. Click **Pending Changes**.
7. In the **Pending Changes** window, select the check box and click **Deploy changes**.

### In the CLI

To modify an AP in the campus AP whitelist:

```
(host) #whitelist-db cpsec modify mac-address <name>
      ap-group <ap_group>
      ap-name <ap_name>
      cert-type {switch-cert|factory-cert}
      description <description>
      mode {disable|enable}
      revoke-text <revoke-text>
      state {approved-ready-for-cert|certified-factory-cert}
```

## Revoking an AP from the Campus AP Whitelist

You can revoke an invalid or rogue AP either by modifying its revoke status (as described in [Modifying an AP in the Campus AP Whitelist on page 79](#)) or by directly revoking it from the campus AP whitelist without modifying any other parameter. When revoking an invalid or rogue AP, enter a brief description why the AP is being revoked. When you revoke an AP from the campus AP whitelist, the campus AP whitelist retains the information of the AP. To revoke an invalid or rogue AP and permanently remove it from the whitelist, delete that entry.

### In the WebUI

To revoke an AP from the campus AP whitelist:

1. In the **Managed Network** node hierarchy, navigate to the **Configuration > Access Points > Whitelist** tab.
2. Click **Campus AP Whitelist** tab.

3. Click on the check box next to the AP you want to revoke and click **Revoke**. The **Revoke** window is displayed.
4. Enter a brief description of why the AP is being revoked in the **Revoke text** field.
5. Click **Submit**.
6. Click **Pending Changes**.
7. In the **Pending Changes** window, select the check box and click **Deploy changes**.

### In the CLI

To revoke an AP via the campus AP whitelist:

```
(host) [mynode] (config) #whitelist-db cpsec revoke mac-address <name> revoke-text <comment>
```

## Deleting an AP from the Campus AP Whitelist

Before deleting an AP from the campus AP whitelist, verify that auto certificate provisioning is either enabled or disabled only for IP addresses that do not include the AP being deleted. If you enable automatic certificate provisioning for an AP that is still connected to the network, you cannot delete it from the campus AP whitelist; the controller immediately re-certifies the AP and re-creates its whitelist entry.

### In the WebUI

To delete an AP from the campus AP whitelist:

1. In the **Managed Network** node hierarchy, navigate to the **Configuration > Access Points > Whitelist** tab.
2. Click **Campus AP Whitelist** tab.
3. Select the check box of the AP that you want to delete, then click **Delete**.
4. Click **Delete**.
5. Click **Pending Changes**.
6. In the **Pending Changes** window, select the check box and click **Deploy changes**.

### In the CLI

To delete an AP from the campus AP whitelist:

```
(host) [mynode] (config) #whitelist-db cpsec del mac-address <name>
```

## Purging a Campus AP Whitelist

Before adding a new managed device to a network using control plane security, purge the campus AP whitelist on the new managed device. To purge a campus AP whitelist execute the following command:

```
(host) [mynode] (config) #whitelist-db cpsec purge
```

## Offloading a Controller Whitelist to ClearPass Policy Manager

This feature allows to externally maintain AP whitelist in a ClearPass Policy Manager server. The controller, if configured to use an external server, can send a RADIUS access request to a ClearPass Policy Manager server. The MAC address of the AP is used as a username and password to construct the access request packet. The ClearPass Policy Manager server validates the RADIUS message and returns the relevant parameters for the authorized APs.

The following supported parameters are associated with the following Vendor Specific Attributes (VSAs). The ClearPass Policy Manager server sends them in the RADIUS access accept packet for authorized APs:

- ap-group: Aruba-AP-Group
- ap-name: Aruba-Location-ID



- ap-remote-ip: Aruba-AP-IP-Address

The following defaults are used when any of the supported parameters are not provided by the ClearPass Policy Manager server in the RADIUS access accept response:

- ap-group: The default ap-group is assigned to the AP.
- ap-name: The MAC address of the AP is used as the AP name.

There is no change in the RAP role assignment. The RAP is assigned the role that is configured in the VPN *default-rap* profile.

## In the WebUI

To assign a ClearPass Policy Manager server to a RAP:

1. Configure a ClearPass Policy Manager server using the WebUI:
  - a. In the **Mobility Master** node hierarchy, navigate to **Configuration > Authentication > Auth Servers** tab.
  - b. Click + in the **Server Groups** table.
  - c. In the **Add Server Group** window, enter the server group name in the **Name** field.
  - d. Click **Submit**.
  - e. Click + in the **All Server** table.
  - f. In the **New Server** window, enter appropriate values in the following fields and click **Submit**:
    - **Name**
    - **IP address / hostname**
    - **Type**
  - g. Select the server created.
  - h. In **Server Options** table, enter a value for the shared **Key** and re-enter the value in the **Retype key** field.
  - i. Click **Submit**.
  - j. Click **Pending Changes**.
  - k. In the **Pending Changes** window, select the check box and click **Deploy changes**.
  - l. Select the server group created in the previous steps. The **Server Group** table is displayed.
  - m. Click + in the **Server Group** table. A list of servers is displayed.
  - n. Select the ClearPass Policy Manager server you wish to map to the server group. Click **Submit**.
  - o. Click **Pending Changes**.
  - p. In the **Pending Changes** window, select the check box and click **Deploy changes**.
2. In the **Mobility Master** node hierarchy, navigate to **Configuration > System > Profiles**.
3. From **All profiles** select **Wireless LAN > VPN Authentication > default-rap > Server Group**.
4. Select the ClearPass Policy Manager server from the **Server Group** drop-down list.
5. Click **Save**.
6. Click **Pending Changes**.
7. In the **Pending Changes** window, select the check box and click **Deploy changes**.

To assign a ClearPass Policy Manager server to a RAP that was initially an Instant AP:

1. Make sure that a ClearPass Policy Manager server is configured on the controller.
2. In the **Mobility Master** node hierarchy, navigate to **Configuration > System > Profiles**.
3. From **All profiles** select **Wireless LAN > VPN Authentication > default-iap > Server Group**.
4. Select the ClearPass Policy Manager server from the **Server Group** drop-down list.

5. Click **Save**.
6. Click **Pending Changes**.
7. In the **Pending Changes** window, select the check box and click **Deploy changes**.

### In the CLI

To add a ClearPass Policy Manager server to a RAP:

Configure a radius server with ClearPass Policy Manager server as host address. In this example **cppm-rad** is the ClearPass Policy Manager server name and **cppm-sg** is the server group name.

```
(host) [md] (config) #aaa authentication-server radius cppm-rad
(host) [md] (RADIUS Server "test") # host 1.1.1.1
```

Add this server to a server group:

```
(host) [md] (config) #aaa server-group cppm-sg
(host) (Server Group "cppm-sg") #auth-server cppm-rad
```

Add this server group to the **default-rap** vpn profile:

```
(host) [md] (config) #aaa authentication vpn default-rap
(host) (VPN Authentication Profile "default-rap") #server-group cppm-sg
```

## Whitelist DB Optimization

In addition to the existing push-based model that syncs whitelist entries to managed devices when they are updated/deleted/revoked from Mobility Master. The Mobility Master introduces a pull-based sync mechanism for the whitelist database (whitelist-DB), in which AP whitelist entries are only synced to the managed devices that require the entry. The pull-based sync mechanism is used when a RAP/CPsec AP terminates on a managed device or if a network is down during a whitelist push, which can prevent messages from going through to the managed devices. The managed device can use this as a fallback mechanism to periodically check if it is in sync with the Mobility Master. If a mismatch is detected, the managed device pulls the new entry from Mobility Master. All whitelist entries are configured from a centralized location on the Mobility Master and synced to appropriate managed devices. Entries can also be configured directly on a managed device for debugging purposes. However, these changes are not synced back to the Mobility Master or any other managed device.

This whitelist-DB optimization provides the following enhancements on Mobility Master:

- Reduced memory footprint.
- Increased performance on the Mobility Master and managed devices.
- Scalability and support for over 1000 managed devices and 10,000 APs on a Mobility Master.
- Scalability and support for managed devices with varying AP capacities.
- Simplified debugging process, as corrupt entries are no longer synced to every managed device on a given Mobility Master.



---

Changes made to the whitelist-DB can only be applied to the postgres database (PgSQL DB) and are not backwards-compatible with ArubaOS versions 6.4.x and earlier.

---

You can view a controller's current sequence number using the CLI:

```
(host) #show whitelist-db seq-pendlist
```



---

In a Mobility Master, only a global list of whitelist entries are available. To view the entries specific to a managed device, login into the particular device to view the whitelist specific to the device.

---

## Configuring Networks with a Backup Mobility Master

This section describes the configuration with a backup Mobility Master .

If your network includes a redundant backup Mobility Master, you *must synchronize the database from the primary Mobility Master to the backup Mobility Master at least once* after all APs are communicating with the controllers over a secure channel. This ensures that all certificates, IPsec keys, and campus AP whitelist entries are synchronized to the backup controller. You should also synchronize the database any time the campus AP whitelist changes (APs are added or removed to ensure that the backup controller has the latest settings).

Mobility Master and backup Mobility Masters can be synchronized using either of the following methods:

- **Manual Synchronization:** Issue the **database synchronize** command to manually synchronize databases from your primary Mobility Master to the backup Mobility Master.
- **Automatic Synchronization:** Schedule automatic database backups using the **database synchronize period** command in configuration mode.



---

If you add a new backup Mobility Master to an existing Mobility Master, you must add the backup Mobility Master as the **lower priority** controller. If you do not add the backup Mobility Master as a lower priority controller, your control plane security keys and certificates may be lost. If you want the new backup Mobility Master to become your primary controller, increase the priority of that controller to a primary controller *after* you have synchronized your data.

---

## Replacing a Controller on a Multi-Controller Network

The procedure to replace a controller within a multi-controller network varies, depending upon the role of that controller, whether the network has a single Mobility Master or a cluster of Mobility Masters, and whether or not the controller has a backup.

### Replacing Controllers in a Single Mobility Master Network

Use the procedures in this section to replace a Mobility Master or managed device in a network environment with a single Mobility Master.

#### Replacing a Managed Device

Follow the steps below to replace a managed device in a single-Mobility Master network:

1. Disconnect the managed device from the network.
2. If you plan on moving the managed device to another location on the network, purge the campus AP whitelist on the managed device.  
Access the command-line interface on the old managed device and issue the **whitelist-db cpsec purge** command.
3. Install the new managed device, but do not connect it to the network. If the managed device has been previously installed on the network, you must ensure that the new managed device has a clean whitelist.
4. Purge the managed device whitelist by executing the **whitelist-db cpsec purge** command on the new managed device.
5. Once the managed device has a valid control plane security certificate and configuration, the managed device receives the campus AP whitelist from the Mobility Master and starts certifying approved APs.
6. APs associated with the new managed device reboots and creates new IPsec tunnels to the controller using the new certificate keys.

## Replacing a Redundant Mobility Master

The control plane security feature requires you to synchronize databases from the primary Mobility Master to the backup Mobility Master at least once after the network is up and running. This ensures that all certificates, keys, and whitelist entries are synchronized to the backup Mobility Master. Because the AP whitelist may change periodically, you should regularly synchronize these settings to the backup Mobility Master. For details, see [Configuring Networks with a Backup Mobility Master on page 83](#).

When you install a new backup Mobility Master, *you must add it as a lower priority* controller than the existing primary Mobility Master. After you install the backup Mobility Master on the network, synchronize the database from the existing primary Mobility Master to the new backup Mobility Master to ensure that all certificates, keys, and whitelist entries required for control plane security are added to the new backup Mobility Master configuration. If you want the new Mobility Master to act as the primary Mobility Master, you can increase that Mobility Master's priority *after* the settings have been synchronized.



---

The control plane security settings of a controller does not change if you upgrade the controller running ArubaOS 6.x to ArubaOS 8.0. If control plane security was already enabled, then it remains enabled after the upgrade, however if control plane security was not enabled previously and you want to use this feature after upgrading, then you must manually enable control plane security.

---

## Troubleshooting Control Plane Security

### Identifying Certificate Problems

If an AP has a problem with its certificate, check the state of the AP in the campus AP whitelist. If the AP is in either the certified-hold-factory-cert or certified-hold-switch-cert states, you may need to manually change the status of that AP before it can be certified.

- **certified-hold-factory-cert:** An AP is put in this state when the controller thinks the AP has been certified with a factory certificate, but the AP requests to be certified again. Because this is not a normal condition, the AP is not approved as a secure AP until you manually change the status of the AP to verify that it is not compromised. If an AP is in this state due to connectivity problems, then the AP recovers and is taken out of this hold state as soon as connectivity is restored.
- **certified-hold-switch-cert:** An AP is put in this state when the controller thinks the AP has been certified with a controller certificate yet the AP requests to be certified again. Because this is not a normal condition, the AP is not be approved as a secure AP until a network administrator manually changes the status of the AP to verify that it is not compromised. If an AP is in this state due to connectivity problems, then the AP recovers and is taken out of this hold state as soon as connectivity is restored.

### Verifying Certificates

If you are unable to configure the control plane security feature, verify that its Trusted Platform Module (TPM) and factory-installed certificates are present and valid by accessing the controller's command-line interface and issuing the **show tpm cert-info** command. If the controller has a valid certificate, the output of the command appears similar to the output in the example below.



---

This command works only on hardware controllers.

---

```
(host) #show tpm cert-info
=====
TPM manufacturing factory certificate
=====
subject= /CN=BA0003137::00:1a:1e:00:89:b8
issuer= /DC=com/DC=arubanetworks/DC=ca/CN=DEVICE-CA1
```

```
serial=2E1DF0D10000004C8EE7
notBefore=Aug  6 22:50:04 2013 GMT
notAfter=Sep 14 03:21:14 2032 GMT
=====
Generated Factory certificate
=====
subject= /CN=BA0003137::00:1a:1e:00:89:b8/L=SW
issuer= /CN=BA0003137::00:1a:1e:00:89:b8
serial=2E1DF0D10000004C8EE7
notBefore=Aug  6 22:50:04 2013 GMT
notAfter=Sep 14 03:21:14 2032 GMT
```

If the controller displays the following output, it may have a corrupted or missing TPM and factory certificates. Contact Aruba support.

```
(host) #show tpm cert-info
Cannot get TPM and Factory Certificate Info.
```

## Disabling Control Plane Security

If you disable control plane security on a Mobility Master or managed device, all APs connected to that controller reboot then reconnect to the controller over a clear channel.

If you disable control plane security for a managed device, APs directly connected to the managed device reboot and reconnect to the managed device over a clear channel.

## Verifying Whitelist Synchronization

To verify if the campus AP whitelist is downloaded from the Mobility Master to managed devices, check the sequence numbers on the Mobility Master and managed device whitelists.

The sequence number value on a Mobility Master should be the same as the sequence number on the managed device.

## Rogue APs

If you enable auto certificate provisioning enabled with the **Auto Cert Allow All** option, any AP that appears on the network receives a certificate. If you notice unwanted or rogue APs connecting to your controller via an IPsec tunnel, verify that automatic certificate provisioning has been disabled, then manually remove the unwanted APs by deleting their entries from the campus AP whitelist.

### Getting Started with ArubaOS WLANs

This chapter gives an overview of ArubaOS WLANs, and describes the procedures to configure a basic WLAN, define VLANs and ports, and enable advanced and optional WLAN and VLAN optimization features.

#### Learn more about ArubaOS WLANs, VLANs and Ports

Click any of the links below for information on the basic steps required to configure a campus WLAN using the WebUI or command-line interfaces, and an general overview of VLAN assignments.

- [Campus WLAN Workflow on page 86](#)
- [Configuring VLANs on page 89](#)
- [Trusted Vs. Untrusted Ports and VLANs on page 96](#)

#### Create a Basic Network Configuration

The following sections describe how to configure the basic port, VLAN and Mobility Master settings .

- [Assign an IP Address to a VLAN on page 97](#)
- [Configuring Trusted/Untrusted Ports and VLANs on page 100](#)
- [Configuring the Mobility Master IP Address on page 102](#)
- [Configuring the Loopback IP Address on page 102](#)
- [Configuring Static IP Routes on page 103](#)

#### Configure Advanced or Optional Network features

The following sections describe how to configure advanced or optional VLAN and Mobility Master settings .

- [Configuring GRE Tunnels on page 104](#)
- [GRE Tunnel Groups on page 110](#)
- [Jumbo Frame Support on page 112](#)
- [PVST+ \(Per-VLAN Spanning Tree Plus\) on page 113](#)
- [Rapid Spanning Tree Protocol \(RSTP\) on page 114](#)
- [PortFast and BPDU Guard for Spanning Tree on page 116](#)
- [Link Layer Discovery Protocol on page 118](#)

### Campus WLAN Workflow

A WLAN can be creating using the New WLAN Wizard in the WebUI, or manually defined using the WebUI or command-line interfaces.

#### Using the New WLAN Wizard in the WebUI

The simplest way to create a new WLAN is to use the **New WLAN** wizard, available in the **Configuration > WLANs** section of the WebUI (**Managed Network** node hierarchy). The wizard walks you through the steps to define and configure the SSID, VLAN, authentication and authorization settings, and default user role for the

WLAN. The configuration options that appear in the WLAN wizard will vary, depending upon the type of WLAN you choose to create.

## Manually Configuring the WLAN in the WebUI

The following workflow lists the tasks to configure a campus WLAN, with a signal SSID, that uses 802.1X authentication. Click any of the links below for details on the configuration procedures for that task.

1. [Configure your authentication servers.](#)
2. [Create an authentication server group](#), and assign the authentication servers you configured in step 1 to that server group.
3. [Configure a firewall access policy](#) for a group of users
4. [Create a user role](#), and assign the firewall access policy you created in step 3 to that user role.
5. [Create an AAA profile.](#)
  - a. Assign the user role defined in step 4 to the AAA profile's **802.1X Authentication Default Role**
  - b. Associate the server group you created in step 2 to the AAA profile.
6. [Create a new SSID profile.](#)
7. [Create a new virtual AP profile.](#)
8. [Associate the virtual AP profile](#) to the AAA profile you created in Step 5.
9. [Associate the virtual AP profile](#) to the SSID profile you created in Step 6.

## Using the CLI

The example below follows the suggested order of steps to configure a virtual AP using the command-line interface.

```
(host) [mynode] (config) #aaa server-group THR-DOT1X-SERVER-GROUP-WPA2
    auth-server Internal

(host) [mynode] (config) #ip access-list session THR-POLICY-NAME-WPA2
    user any any permit

(host) [mynode] (config) #user-role THR-ROLE-NAME-WPA2
    access-list session THR-POLICY-NAME-WPA2

(host) [mynode] (config) #aaa server-group THR-DOT1X-SERVER-GROUP-WPA2
    auth-server Internal

(host) [mynode] (config) #aaa profile THR-AAA-PROFILE-WPA2
    dot1x-default-role THR-ROLE-NAME-WPA2
    dot1x-server-group THR-DOT1X-SERVER-GROUP-WPA2

(host) [mynode] (config) #wlan ssid-profile THR-SSID-PROFILE-WPA2
    essid THR-WPA2
    opmode wpa2-aes

(host) [mynode] (config) #wlan virtual-ap THR-VIRTUAL-AP-PROFILE-WPA2
    ssid-profile THR-SSID-PROFILE-WPA2
    aaa-profile THR-AAA-PROFILE-WPA2
    vlan 60

(host) [mynode] (config) #ap-group THRHQ1-STANDARD
    virtual-ap THR-VIRTUAL-AP-PROFILE-WPA2
```

## Understanding VLAN Assignments

A client is assigned to a VLAN by one of several methods, in order of precedence. The assignment of VLANs are (from lowest to highest precedence):

1. The default VLAN is the VLAN configured for the WLAN (see [WLAN Configuration Profiles on page 410](#)).
2. Before client authentication, the VLAN can be derived from rules based on client attributes (SSID, BSSID, client MAC, location, and encryption type). A rule that derives a specific VLAN takes precedence over a rule that derives a user role that may have a VLAN configured for it.
3. After client authentication, the VLAN can be configured for a default role for an authentication method, such as 802.1X or VPN.
4. After client authentication, the VLAN can be derived from attributes returned by the authentication server (*server-derived rule*). A rule that derives a specific VLAN takes precedence over a rule that derives a user role that may have a VLAN configured for it.
5. After client authentication, the VLAN can be derived from Microsoft Tunnel attributes (Tunnel-Type, Tunnel Medium Type, and Tunnel Private Group ID). All three attributes must be present as shown below. This does not require a server-derived rule. For example:

```
Tunnel-Type="VLAN" (13)
Tunnel-Medium-Type="IEEE-802" (6)
Tunnel-Private-Group-Id="101"
```

6. After client authentication, the VLAN can be derived from Vendor Specific Attributes (VSA) for RADIUS server authentication. This does not require a server-derived rule. If a VSA is present, it overrides any previous VLAN assignment. For example:

```
Aruba-User-VLAN
Aruba-Named-User-VLAN
```

### VLAN Derivation Priorities for VLAN types

The VLAN derivation priorities for VLAN is defined below in the increasing order:

1. Default or Virtual AP VLAN
2. VLAN from Initial role
3. VLAN from User Derivation Rule (UDR) role
4. VLAN from UDR
5. VLAN from DHCP option 77 UDR role (wired clients)
6. VLAN from DHCP option 77 UDR (wired clients)
7. VLAN from MAC-based Authentication default role
8. VLAN from Server Derivation Rule (SDR) role during MAC-based Authentication
9. VLAN from SDR during MAC-based Authentication
10. VLAN from Vendor Specific Attributes (VSA) role during MAC-based Authentication
11. VLAN from VSA during MAC-based Authentication
12. VLAN from Microsoft Tunnel attributes during MAC-based Authentication
13. VLAN from 802.1X default role
14. VLAN from SDR role during 802.1X
15. VLAN from SDR during 802.1X
16. VLAN from VSA role during 802.1X
17. VLAN from VSA during 802.1X
18. VLAN from Microsoft Tunnel attributes during 802.1X
19. VLAN from DHCP options role



## 20. VLAN from DHCP options



---

A VLAN from DHCP options has highest priority for VLAN derivation. Note, however, that DHCP options are not considered for derivation if the Aruba VSA **ARUBA\_NO\_DHCP\_FINGERPRINT (14)** was sent for the user.

---

Use the following command to display user VLAN derivation debug information:

```
(host) [mynode] #show aaa debug vlan user [ip|ipv6|mac]
```

### Configuring Multiple Wired Uplink Interfaces (Active-Standby)

You can assign up to four VLAN interfaces to operate in active-standby topology. An active-standby topology provides redundancy so that when an active interface fails, the user traffic can failover to the standby interface.

To allow Mobility Master to obtain a dynamic IP address for a VLAN, enable the DHCP or PPPoE client on Mobility Master for the VLAN. For more information, see [Assign an IP Address to a VLAN](#)

## Configuring VLANs

Managed Devices operate as layer-2 switches that use a VLAN as a broadcast domain. As a layer-2 switch, the managed device requires an external router to route traffic between VLANs. The managed device can also operate as a layer-3 switch that can route traffic between VLANs defined on Mobility Master.

You can configure one or more physical ports on the managed device to be members of a VLAN. Additionally, each wireless client association constitutes a connection to a *virtual port on the managed device*, with membership in a specified VLAN. You can place all authenticated wireless users into a single VLAN or into different VLANs, depending upon your network. VLANs can remain inside the managed device, or they can extend outside the managed device through 802.1q VLAN tagging.

You can optionally configure an IP address and netmask for a VLAN. The IP address is *up* when at least one physical port in the VLAN is up. The VLAN IP address can be used as a gateway by external devices; packets directed to a VLAN IP address that are not destined for the managed device are forwarded according to the managed device's IP routing table.

This section includes the following topics:

- [Creating and Updating VLANs on page 89](#)
- [Creating a Named VLAN on page 90](#)
- [Creating a Named VLAN on page 90](#)
- [Role Derivation for Named VLAN Pools on page 91](#)
- [Adding a Bandwidth Contract to the VLAN on page 92](#)
- [Optimizing VLAN Broadcast and Multicast Traffic on page 92](#)
- [Inter-VLAN Routing on page 93](#)

### Creating and Updating VLANs

You can create and update a single VLAN or bulk VLANs.

#### In the WebUI

1. In the **Mobility Master** node hierarchy, navigate to the **Configuration > Interfaces > VLANs** page.
2. Click + to create a new VLAN. (To edit an existing VLAN, click the VLAN entry.) See [Creating Bulk VLANs In the WebUI on page 90](#) to create a range of VLANs.

- a. Enter a name for the new VLAN.
- b. In the **VLAN ID/Range** field, enter a valid VLAN ID. (Valid values are from 1 to 4094, inclusive).
- c. Click **Submit**.
3. Click **Submit**.
4. Click **Pending Changes**.
5. In the **Pending Changes** window, select the check box and click **Deploy changes**.
6. To add physical ports to the VLAN, go to the **Ports** page. To associate the VLAN with specific port-channels, select **Port-Channels**.
  - a. If you selected **Port**, select the port(s) you want to associate with the VLAN from the **Ports** table. For each port, select the new VLAN from the **VLAN** drop-down list.
  - b. If you selected **Port-Channel**, select the specific channel number you want to associate with the VLAN from the **Port Channel** table.
  - c. Click **Submit**.
7. Click **Submit**.
8. Click **Pending Changes**.
9. In the **Pending Changes** window, select the check box and click **Deploy changes**.

### In the CLI

Use the following commands:

```
(host) [mynode] (config) #vlan <id>
(host) [mynode] (config) #interface gigabitethernet <slot>/<module>/<port>
(host) [mynode] (config-if) #switchport access vlan <vlan>
```

### Creating Bulk VLANs In the WebUI

1. In the **Mobility Master** node hierarchy, navigate to the **Configuration > Interfaces > VLANs** page.
2. To add multiple VLANs at one time, click **+** on the **VLANs** page.
  - a. In the **New VLAN** pop-up window, enter a range of VLANs in the **VLAN ID/Range** field that you want to create at once. For example, to add VLAN IDs numbered 200-300 and 302-350, enter 200-300, 302-350.
  - b. Click **Submit**.
3. To add physical ports to a VLAN, select the VLAN.
  - a. In the **Port Members** table, click **Edit**.
  - b. Select and move the port(s) from the **Available** list to the **Selected** list.
  - c. Click **OK**.
4. Click **Submit**.
5. Click **Pending Changes**.
6. In the **Pending Changes** window, select the check box and click **Deploy changes**.

### In the CLI

Use the following commands:

```
(host) [mynode] (config) #vlan <id>
(host) [mynode] (config) #vlan <id> range <range>
```

### Creating a Named VLAN

Refer to the section [Address Pool Management on page 229](#).

## Role Derivation for Named VLAN Pools

You can configure Named VLANs under user rule, server derivation, user derivation, and VSA.



---

You cannot modify a VLAN name, so choose the name carefully.

---

Named VLANs (single VLAN IDs or multiple VLAN IDs) can only be assigned to tunnel mode VAP's and wired profiles. They can also be assigned to user roles, user rule derivation, server derivation, and VSA for tunnel and bridge mode.

For tunnel mode, named VLANs that have the assignment type "hash" and "even" are supported.

For bridge mode only, named VLANs with the assignment type "hash" are supported. If a named VLAN with "even" assignment is assigned to a user rule, user role, server derivation or VSA, than the "hash" assignment is applied and the following error message displays:

"named VLAN assignment type EVEN not supported for bridge. Applying HASH algorithm to retrieve vlan-id"



---

L2 roaming is not supported with an even VLAN assignment.

---

### In the CLI

To apply a named VLAN in a user rule, use the following CLI commands:

```
(host) [mynode] (config) #aaa derivation-rules user <name>
(host) [mynode] (user-rule) #set vlan condition <rule-type> <attribute> <value> set-value
{<role>|<vlan>} [description <rule description>] [position <number>]
```

To apply a named VLAN in a user role, use the following CLI commands:

```
(host) [mynode] (config) #user-role <name>
(user) [mynode] (config-role) #vlan <string>
```

To apply a named VLAN in server derivation, use the following CLI commands:

```
(host) [mynode] (config) #aaa server-group <group>
(user) [mynode] (Server Group) set vlan condition <attribute> contains|ends-with|equals|not-
equals|starts-with <string> set-value <set-value-str> [position <number>]
```

For a named VLAN derivation using VSA, configure the RADIUS server using these values:

```
Aruba-Named-UserVLAN 9 String Aruba 14823
```

### In the WebUI

To apply a named VLAN to a user rule:

1. In the **Managed Network** node hierarchy, navigate to **Configuration > Authentication > User Rules**.
2. Select a user rule from the **User Rules Summary** table.
3. Click **+** to add a new rule.
4. Select **VLAN** from the **Set Type** drop-down list.
5. Select a VLAN from the **VLAN** drop-down list.
6. Configure the remaining profile settings: **Rule Type**, **Condition**, **Value**, and **Description**. Users are assigned the selected VLAN when the rule matches.
7. Click **Submit**.
8. Click **Pending Changes**.
9. In the **Pending Changes** window, select the check box and click **Deploy changes**.

To apply a named VLAN to a user role:

1. In the **Managed Network** node hierarchy, navigate to **Configuration > Roles & Policies > Roles**.
2. Select a role from the **Roles** table, and then click **Show Advanced View**.
3. Under **More**, select a VLAN from the **VLAN** drop-down list.
4. Click **Submit**.
5. Click **Pending Changes**.
6. In the **Pending Changes** window, select the check box and click **Deploy changes**.

To apply a named VLAN to a server derivation (server group):

1. In the **Mobility Master** node hierarchy, navigate to **Configuration > Authentication > Auth Servers**.
2. Select a server group from the **Server Groups** table.
3. Under **Server Rules**, click + to add a new rule.
4. Select **set vlan** from the **Action** drop-down list.
5. Select a VLAN from the **Vlan** drop-down list.
6. Configure the remaining profile settings: **Attribute**, **Operation**, and **Operand**. Users are assigned the selected VLAN when the rule matches.
7. Click **Submit**.
8. Click **Pending Changes**.
9. In the **Pending Changes** window, select the check box and click **Deploy changes**.

## Adding a Bandwidth Contract to the VLAN

Bandwidth contracts on a VLAN can limit broadcast and multicast traffic. ArubaOS includes an internal exception list to allow broadcast and multicast traffic using the VRRP, LACP, OSPF, PVST, and STP protocols. To remove per-VLAN bandwidth contract limits on an additional broadcast or multicast protocol, add the MAC address for that broadcast/multicast protocol to the VLAN Bandwidth Contracts MAC Exception List.

The command in the example below adds the MAC address for CDP (Cisco Discovery Protocol) and VTP (Virtual Trunking Protocol) to the list of protocols that are not limited by VLAN bandwidth contracts.

```
(host) [mynode] (config) #vlan-bwcontract-explist mac <mac>
```

To show entries in the VLAN bandwidth contracts MAC exception list execute the following command:

```
(host) [mynode] (config) #show vlan-bwcontract-explist internal
```

## Optimizing VLAN Broadcast and Multicast Traffic

Broadcast and Multicast (BCMC) traffic from APs, remote APs, or distributions terminating on the same VLAN floods all VLAN member ports. This causes critical bandwidth wastage, especially when the APs are connected to an L3 cloud where the available bandwidth is limited or expensive. Suppressing the VLAN BCMC traffic to prevent flooding can result in loss of client connectivity.

To effectively prevent flooding of BCMC traffic on all VLAN member ports, use the **bcmc-optimization** parameter under the `interface vlan` command. This parameter ensures controlled flooding of BCMC traffic without compromising the client connectivity. This option is disabled by default. You must enable this parameter for the controlled flooding of BCMC traffic.




---

If you enable BCMC Optimization on uplink ports, the managed device-generated Layer-2 packets will be dropped.

---

The **bcmc-optimization** parameter has the following exemptions:

- All DHCP traffic will continue to flood VLAN member ports even if you enable the **bcmc-optimization** parameter.

- ARP broadcasts and VRRP (multicast) traffic will still be allowed.

You can configure BCMC optimization using the WebUI or CLI.

### In the WebUI

1. In the **Mobility Master** node hierarchy, navigate to **Configuration > Interfaces > VLANs**.
2. Select a VLAN from the **VLANs** table.
3. Under **Vlan Ids**, select the VLAN ID number.
4. Navigate to the **IPv4** tab for the selected VLAN ID.
5. Click **Other Option** to expand it.
6. Set the **BCMC optimization** to **Enabled** for the selected VLAN.
7. Click **Submit**.
8. Click **Pending Changes**.
9. In the **Pending Changes** window, select the check box and click **Deploy changes**.

### In the CLI

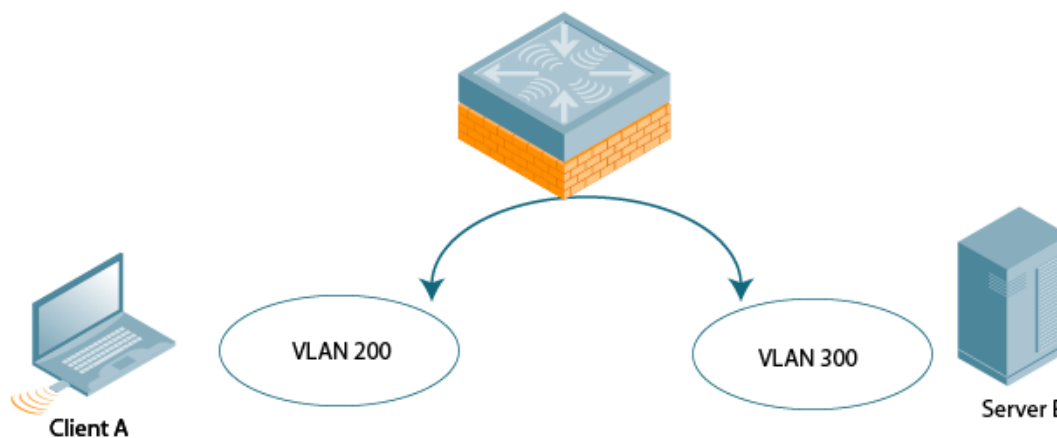
```
(host) [mynode] (config) #interface vlan <vlan>
(host) [mynode] (config-subif) #bcmc-optimization
(host) [mynode] (config-subif) #show interface vlan <vlan>
```

## Inter-VLAN Routing

On the managed device, you can map a VLAN to a layer-3 subnetwork by assigning a static IP address and a netmask, or by configuring a DHCP or PPPoE server to provide a dynamic IP address and netmask to the VLAN interface. The managed device, acting as a layer-3 switch, routes traffic between VLANs that are mapped to IP subnetworks; this forwarding is enabled by default.

In [Figure 12](#), VLAN 200 and VLAN 300 are assigned the IP addresses 2.1.1.1/24 and 3.1.1.1/24, respectively. Client A in VLAN 200 is able to access server B in VLAN 300 and vice-versa, provided that there is no firewall rule configured on the managed device to prevent the flow of traffic between the VLANs.

**Figure 12** *Default Inter-VLAN Routing*



You can optionally disable layer-3 traffic forwarding to or from a specified VLAN. When you disable layer-3 forwarding on a VLAN, the following restrictions apply:

- Clients on the restricted VLAN can ping each other, but cannot ping the VLAN interface on the managed device. Forwarding of inter-VLAN traffic is blocked.

- IP mobility does not work when a mobile client roams to the restricted VLAN. You must ensure that a mobile client on a restricted VLAN is not allowed to roam to a non-restricted VLAN. For example, a mobile client on a guest VLAN will not be able to roam to a corporate VLAN.

To disable layer-3 forwarding for a VLAN configured on the managed device:

### In the WebUI

1. In the **Mobility Master** node hierarchy, navigate to the **Configuration > Interfaces > VLANs** page.
2. Select a VLAN from the **VLANs** table.
3. Under **Vlan Ids**, select the VLAN ID number.
4. Navigate to the **IPv4** tab for the selected VLAN ID.
5. Click **IP Address Assignment** to expand it.
6. In the **IP assignment** field, configure the VLAN to either obtain an IP address dynamically (via DHCP or PPPoE) or to use a static IP address and netmask.
7. Click **Submit**.
8. Click **Other Option** to expand it.
9. Set **Inter-VLAN routing** to **Disabled**.
10. Click **Submit**.
11. Click **Pending Changes**.
12. In the **Pending Changes** window, select the check box and click **Deploy changes**.

## Configuring Source NAT to Dynamic VLAN Address

When a VLAN interface obtains an IP address through DHCP or PPPoE, a NAT pool (dynamic-srcnat) and a session ACL (dynamic-session-acl) are automatically created which reference the dynamically-assigned IP addresses. This allows you to configure policies that map private local addresses to the public address(es) provided to the DHCP or PPPoE client. Whenever the IP address on the VLAN changes, the dynamic NAT pool address also changes to match the new address.

For example, the following rule for a guest policy denies traffic to any network addresses. .

### In the WebUI

1. In the **Mobility Master** node hierarchy, navigate to the **Configuration > Roles & Policies > Policies** page. Click **+** to add the policy **guest**.
2. Select the new **guest** policy from the **Policies** table.
3. To add a rule, click **+** in the **Policies > guest** table.
  - d. Select **Deny** from the **Action** drop-down list.
  - e. Select **Any** from the **MAC address** drop-down list.
  - f. Set **Mirror** to **Disabled**.
  - g. Click **Submit**.
  - h. Click **Pending Changes**.
  - i. In the **Pending Changes** window, select the check box and click **Deploy changes**.

### In the CLI

Use the following commands:

```
(host) [mynode] (config) #ip access-list session guest
    any network any deny
```

## Configuring Source NAT for VLAN Interfaces

The example configuration in the previous section illustrates how to configure source NAT using a policy that is applied to a user role. You can also enable source NAT for a VLAN interface to perform NAT on the source address for *all* traffic that exits the VLAN.

All outbound traffic can enable NAT with the IP address of the VLAN interface as the source address; while the locally routed traffic is sent without any address translation.

Traditionally, ArubaOS supported only IP NAT Inside feature where traffic performs NAT with the desired IP address of the VLAN interface as the source address which was useful for only traffic going out of uplink VLAN interface. However, for traffic which needed local routing was also going through unnecessary address translation. Now, this feature resolves this issue by allowing only outbound traffic to perform NAT.



---

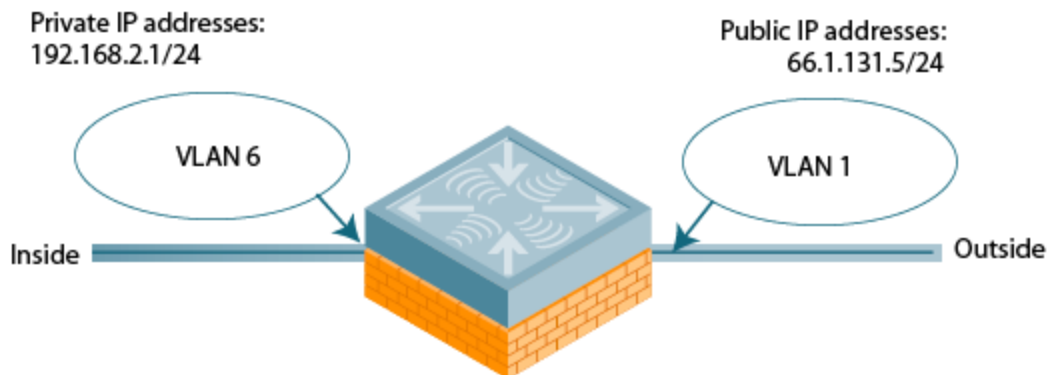
Do not enable the **NAT translation for inbound traffic** option for VLAN 1, as this will prevent IPsec connectivity between Mobility Master and its IPsec peers.

---

### Sample Configuration

In the following example, the managed device operates within an enterprise network. VLAN 1 is the outside VLAN, and traffic from VLAN 6 is source NATed using the IP address of the managed device. The IP address assigned to VLAN 1 is used as the managed device's IP address; thus traffic from VLAN 6 would be source NATed to 66.1.131.5:

**Figure 13** Example: Source NAT using the Managed Device's IP Address



### In the WebUI

1. In the **Mobility Master** node hierarchy, navigate to the **Configuration > Interfaces > VLANs** page. Click **+** to configure VLAN 6 (VLAN 1 is configured through the Initial Setup).
  - a. Enter **6** for the VLAN ID.
  - b. Click **Submit**.
2. Select VLAN 6.
  - a. Navigate to the **IPv4** tab for VLAN 6.
  - b. Click **IP Address Assignment** to expand it.
  - c. Enter **192.168.2.1** for the **IP4 address**.
  - d. Click **Submit**.
  - e. Click **Other Option** to expand it.
  - f. Set **Source NAT** to **Enabled**.
  - g. Click **Submit**.

- h. Click **Pending Changes**.
  - i. In the **Pending Changes** window, select the check box and click **Deploy changes**.
3. Select VLAN 1.
    - a. Navigate to the **IPv4** tab for VLAN 6.
    - b. Click **IP Address Assignment** to expand it.
    - c. Enter **66.1.131.5** for the **IPv4 address**.
    - d. Click **Submit**.
    - e. Click **Other Option** to expand it.
    - f. Set **Source NAT** to **Enabled**.
    - g. Click **Submit**.
    - h. Click **Pending Changes**.
    - i. In the **Pending Changes** window, select the check box and click **Deploy changes**.

### In the CLI

Use the following commands:

```
(host) [mynode] (config) #interface vlan 1
ip address 66.1.131.5 255.255.255.0
ip nat outside
(host) [mynode] (config) #interface vlan 6
ip address 192.168.2.1 255.255.255.0
ip nat inside
```

## Trusted Vs. Untrusted Ports and VLANs

Both Fast Ethernet and Gigabit Ethernet ports can be set to access or trunk mode. A port is in access mode enabled by default and carries traffic only for the VLAN to which it is assigned. In trunk mode, a port can carry traffic for multiple VLANs.

For a trunk port, specify whether the port will carry traffic for all VLANs configured on the managed device or for specific VLANs only. You can also specify the native VLAN for the port. A trunk port uses 802.1q tags to mark frames for specific VLANs, However, frames on a native VLAN are not tagged.




---

For more information on configuring trusted and untrusted ports or VLANs, see [Configuring Trusted/Untrusted Ports and VLANs on page 100](#)

---

### Classifying Traffic as Trusted or Untrusted

You can classify wired traffic based not only on the incoming physical port and channel configuration, but also on the VLAN associated with the port and channel.

#### About Trusted and Untrusted Physical Ports

Physical ports on the managed device are trusted and usually connected to internal networks by default, while untrusted ports connect to third-party APs, public areas, or other networks to which you can apply access controls. When you define a physical port as untrusted, traffic passing through that port needs to go through a predefined access control list policy.

#### About Trusted and Untrusted VLANs

You can also classify traffic as trusted or untrusted based on the VLAN interface and port or channel. This means that wired traffic on the incoming port is trusted only when the port's associated VLAN is also trusted; otherwise the traffic is untrusted. When a port and its associated VLANs are untrusted, any incoming and



outgoing traffic must pass through a predefined ACL. For example, this setup is useful if your company provides wired user guest access, and you want guest user traffic to pass through an ACL to connect to a captive portal.

You can set a range of VLANs as trusted or untrusted in trunk mode. The following table lists the port, VLAN and the trust/untrusted combination to determine if traffic is trusted or untrusted. Both the port and the VLAN have to be configured as trusted for traffic to be considered as trusted. If the traffic is classified as untrusted, then traffic must pass through the selected session access control list and firewall policies.

**Table 20:** *Classifying Trusted and Untrusted Traffic*

Port	VLAN	Traffic Status
Trusted	Trusted	Trusted
Untrusted	Untrusted	Untrusted
Untrusted	Trusted	Untrusted
Trusted	Untrusted	Untrusted

## Assign an IP Address to a VLAN

A VLAN on the managed device obtains its IP address in one of the following ways:

- You can manually configure it. This is the default method and is described in [Assign an IP Address to a VLAN on page 97](#). At least one VLAN on the managed device must be assigned a static IP address.
- Dynamically assigned from a Dynamic Host Configuration Protocol (DHCP) or Point-to-Point Protocol over Ethernet (PPPoE) server.

### Assigning a Static Address to a VLAN

You can manually assign a static IP address to a VLAN on the managed device. At least one VLAN on the managed device should have a static IP address.

#### In the WebUI

1. In the **Mobility Master** node hierarchy, navigate to the **Configuration > Interfaces > VLANs** page. Select a VLAN from the **VLANs** table, and then select a VLAN ID under **Vlan Ids**.
2. Under **IPv4**, select **Static** from the **IP assignment** drop-down list.
3. Enter the **IPv4 address** of the VLAN interface.
4. Select the type of circuit-specific information to be forwarded to the DHCP server from the **Option-82** drop-down list.
5. Enter an **MTU** value for the VLAN, between 1280 and 1500.
6. Enable or disable **Suppress ARP**. If enabled, the managed device prevents flooding of ARP broadcasts on all untrusted interfaces. This is disabled by default.
7. Click **Submit**.
8. Click **Pending Changes**.
9. In the **Pending Changes** window, select the check box and click **Deploy changes**.

#### In the CLI

```
(host) [mynode] (config) #interface vlan <vlan>
```

```
ip address <ipaddr> <ipmask>
```

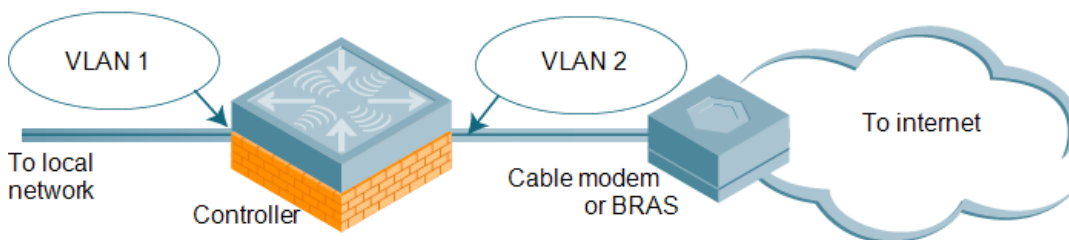
## Configuring a VLAN to Receive a Dynamic Address

In a branch office, you can connect a managed device to an uplink switch or server that dynamically assigns IP addresses to connected devices. For example, you can connect the managed device to a DSL or cable modem, or a broadband remote access server (BRAS). The following figure shows a branch office where a managed device connects to a cable modem. VLAN 1 has a static IP address, while VLAN 2 has a dynamic IP address assigned via DHCP or PPPoE from the uplink device.

The following restrictions apply when enabling the DHCP or PPPoE client on the managed device:

- You can enable the DHCP/PPPoE client multiple uplink VLAN interfaces (up to four) on the managed device; these VLANs cannot be VLAN 1.
- Only one port in the VLAN can be connected to the modem or uplink switch.
- At least one interface in the VLAN must be in the up state before the DHCP/PPPoE client requests an IP address from the server.

**Figure 14** IP Address Assignment to VLAN via DHCP or PPPoE



## Enabling the DHCP Client

The DHCP server assigns an IP address for a specified amount of time called a lease. The managed device automatically renews the lease before it expires. When you shut down the VLAN, the DHCP lease is released.

### In the WebUI

1. In the **Mobility Master** node hierarchy, navigate to the **Configuration > Interfaces > VLANs** page.
2. Select a VLAN from the **VLANs** table, and then select a VLAN ID under **Vlan Ids**.
3. Under **IPv4**, select **DHCP** from the **IP assignment** drop-down list.
4. Enter the **Client ID** and select a link from the **Uplink wired** drop-down list.
5. Enter a priority value for the VLAN ID in the **Uplink Priority** field. All wired uplink interfaces have the same priority by default. If you want to use an active-standby topology, then prioritize each uplink interface by entering a different priority value (1– 4) for each uplink interface.
6. Enter the **Uplink weight** and **MTU** value for the VLAN, between 1280 and 1500.
7. Click **Submit**.
8. Click **Pending Changes**.
9. In the **Pending Changes** window, select the check box and click **Deploy changes**.

### In the CLI

In this example, the DHCP client has the client ID name *myclient*, and the interface VLAN 62 has an uplink priority of 2:

```
(host) [mynode] (config) #interface vlan 62
(host) [mynode] (config) #uplink wired vlan 62 priority 2
```

```
(host) [mynode] (config) #interface vlan 62 ip address dhcp-client client-id myclient
```

## Enabling the PPPoE Client

To authenticate the BRAS and request a dynamic IP address, the managed device must have the following configured:

- PPPoE user name and password to connect to the DSL network
- PPPoE service name: either an ISP name or a class of service configured on the PPPoE server

When you shut down the VLAN, the PPPoE session terminates.

### In the WebUI

1. In the **Mobility Master** node hierarchy, navigate to the **Configuration > Interfaces > VLANs** page.
2. Select the previously-created VLAN.
3. Select a VLAN from the **VLANs** table, and then select a VLAN ID under **Vlan Ids**.
4. Under **IPv4**, select **PPPoE** from the **IP assignment** drop-down list.
5. Enter the **Service name**, **User name**, and **Password** for the PPPoE session.
6. Enter a priority value for the VLAN ID in the **UpLink Priority** field. All wired uplink interfaces have the same priority by default. If you want to use an active-standby topology, then prioritize each uplink interfaces by entering a different priority value (1– 4) for each uplink interface.
7. Enter an **MTU** value for the VLAN, between 1280 and 1500.
8. Click **Submit**.
9. Click **Pending Changes**.
10. In the **Pending Changes** window, select the check box and click **Deploy changes**.

### In the CLI

In this example, a PPOE service name, username, and password are assigned, and the interface VLAN 14 has an uplink priority of 3:

```
(host) [mynode] (config) #interface vlan 14
ip address pppoe
ip pppoe-service-name <service_name>
pppoe-username <username>
ip pppoe-password <password>
(host) [mynode] (config) #uplink wired vlan 14 priority 3
```

## Default Gateway from DHCP/PPPoE

You can specify that the router IP address obtained from the DHCP or PPPoE server be used as the default gateway for the managed devices.

### In the WebUI

1. In the **Mobility Master** node hierarchy, navigate to the **Configuration > Interfaces > IP Routes** page.
2. Click **Dynamic Default Gateway** to expand it. Set the following to **Enabled**:
  - **DHCP** - Use DHCP when available to obtain default gateway.
  - **PPPoE** - Use PPPOE when available to obtain default gateway.
  - **Cellular** - Use Cell interface when available to obtain default gateway.
3. Click **Submit**.
4. Click **Pending Changes**.
5. In the **Pending Changes** window, select the check box and click **Deploy changes**.

### In the CLI

```
(host) [mynode] (config) #ip default-gateway import {cell|cell-cost <cost>|dhcp|dhcp-cost <cost>|pppoe|pppoe-cost <cost>}
```

## Configuring DNS/WINS Server from DHCP/PPPoE

The DHCP or PPPoE server can also provide the IP address of a DNS server or NetBIOS name server, which can be passed to wireless clients through the managed device's internal DHCP server.

For example, the following configures the DHCP server on the managed device to assign addresses to authenticated employees; the IP address of the DNS server obtained by the managed device via DHCP/PPPoE is provided to clients along with their IP address.

### In the WebUI

1. In the **Managed Network** node hierarchy, navigate to the **Configuration > Services > DHCP Server** page.
2. Set the DHCP server to **Enabled**.
3. Under **Pool Configuration**, click **+**. The **Add New Pool Configuration** window appears.
4. For **Pool Name**, enter employee-pool.
5. For **Default Routers**, enter 10.1.1.254.
6. For **DNS Servers**, select **Import from DHCP/PPPoE**.
7. For **WINS Servers**, select **Import from DHCP/PPPoE**.
8. For **Network**, enter 10.1.1.0 for **IP address** and 255.255.255.0 for **IP mask**.
9. Click **Submit**.
10. Click **Pending Changes**.
11. In the **Pending Changes** window, select the check box and click **Deploy changes**.

### In the CLI

Use the following commands:

```
(host) [mynode] (config) #ip dhcp pool employee-pool
    default-router 10.1.1.254
    dns-server import
    netbios-name-server import
    network 10.1.1.0 255.255.255.0
```

## Configuring Trusted/Untrusted Ports and VLANs

Use the following procedures to define access ports and VLANs as trusted or untrusted.



---

For more information on trusted vs untrusted ports and VLANs, see [Trusted Vs. Untrusted Ports and VLANs on page 96](#)

---

### Configuring An Ethernet port as an Untrusted Access Port

You can configure an Ethernet port as an untrusted access port, assign VLANs and classify them as untrusted, and designate a policy through which VLAN traffic on this port must pass.

### In the WebUI

1. In the **Mobility Master** node hierarchy, navigate to the **Configuration > Interfaces > Ports** page.
2. Select the port you want to configure from the **Ports** table.
3. In the **Trust** drop-down list, select **Untrusted** to make the port untrusted. The default is **Trusted**.

4. In the **Mode** drop-down list, select **Access**.
5. From the **VLAN** drop-down list, select the **VLAN** whose traffic will be carried by this port.
6. In the **VLAN trust** drop-down list, select **Untrusted** to make the VLAN untrusted. The default is Trusted.
7. In the **VLAN policy** drop-down list, select the policy through which VLAN traffic must pass. You can select a policy for both trusted and untrusted VLANs.
8. Select whether **Tunneled node** should be **Enabled** or **Disabled**.
9. Click **Submit**.
10. Click **Pending Changes**.
11. In the **Pending Changes** window, select the check box and click **Deploy changes**.

## In the CLI

In this example,

```
(host) [mynode] (config) #interface range gigabitethernet <slot>/<module-start>/<port-start>-<module-end>/<port-end>
(host) [mynode] (config-if)#switchport access
(host) [mynode] (config-if)#no trusted
(host) [mynode] (config-if)#switchport access vlan <vlan>
(host) [mynode] (config-if)#no trusted vlan <vlan>
(host) [mynode] (config-if)#ip access-group ap-acl session vlan <vlan>
(host) [mynode] (config-if)#ip access-group validuserethacl in
(host) [mynode] (config-if)#ip access-group validuserethacl out
(host) [mynode] (config-if)#ip access-group validuser session
```

## Configuring Trusted and Untrusted Ports and VLANs in Trunk Mode

The following procedures configure a range of Ethernet ports as untrusted native trunks ports, assign VLANs and classify them as untrusted, and designate a policy through which VLAN traffic on the ports must pass.

### In the WebUI

1. In the **Mobility Master** node hierarchy, navigate to the **Configuration > Interfaces > Ports** page.
2. Select the port you want to configure from the **Ports** table.
3. For **Mode** select **Trunk**.
4. To specify the native VLAN, select a VLAN from the **Native VLAN** drop-down list.
5. Choose one of the following options from the **Allowed VLANs** drop-down list to control the type of traffic the port carries:
  - **Allow all:** The port carries traffic for all VLANs.
  - **Allow specified VLANs:** The port carries traffic for all VLANs selected. Click + to specify a **VLAN**. You can select whether the VLAN is **Trusted** or **Untrusted**.
6. Click **Submit**.
7. Click **Pending Changes**.
8. In the **Pending Changes** window, select the check box and click **Deploy changes**.

### In the CLI

Use the following examples:

```
(host) [mynode] (config) #interface gigabitethernet <slot>/<module>/<port>
(host) [mynode] (config-if)#description <string>
(host) [mynode] (config-if)#trusted {vlan <word>}
(host) [mynode] (config-range)#switchport mode trunk
(host) [mynode] (config-if)#switchport trunk native vlan <vlan>
(host) [mynode] (config-range)#ip access-group test session vlan <vlan>
```

## Configuring the Mobility Master IP Address

The Mobility Master or managed device's IP address is used to communicate with external devices such as APs.



---

IP addresses used by the Mobility Master or managed device are not limited to its own IP address.

---

You can set the IP address to the loopback interface address or to an existing VLAN ID address. This allows you to force the IP address to be a specific VLAN interface or loopback address across multiple machine reboots. Once you configure an interface to be the Mobility Master or managed device's IP address, that interface address cannot be deleted until you remove it from the IP configuration.

If the IP address is not configured, the Mobility Master or managed device's IP defaults to the current loopback interface address. If the loopback interface address is not configured then the first configured VLAN interface address is selected. Generally, VLAN 1 is the factory default setting, and thus, becomes the IP address.

### In the WebUI

1. In the **Mobility Master** or **Managed Network** node hierarchy, navigate to the **Configuration > System > General** page.
2. Expand the **Controller IP address** section.
3. Select the address you want to set as the IP address of the Mobility Master or managed device from the **IPv4 address or IPv6 address** drop-down lists. This list only contains VLAN IDs with statically assigned IP addresses. If you have previously configured a loopback interface IP address, then it will also appear in this list. Dynamically assigned IP addresses, such as DHCP/PPPOE, do not appear.
4. Click **Submit**.
5. Click **Pending Changes**.
6. In the **Pending Changes** window, select the check box and click **Deploy changes**.



---

Any change in the IP address of the Mobility Master or managed device requires a reboot.

---

7. In the **Mobility Master** node hierarchy, navigate to the **Maintenance > Software Management > Reboot** page to reboot Mobility Master and apply the IP address update.
8. Click **Yes** to save the configuration.
9. Click **Reboot**.
10. **Mobility Master** boots up with the updated IP address of the selected VLAN ID.

### In the CLI

```
(host) [mynode] (config) #controller-ip [loopback|vlan <vlan-id>]
```

## Configuring the Loopback IP Address

The loopback IP address is a logical IP interface that is used to communicate with APs. The loopback address is used as the Mobility Master or managed device's IP address for terminating VPN and GRE tunnels, originating requests to RADIUS servers, and accepting administrative communications. You configure the loopback address as a host address with a 32-bit netmask. The loopback address is not bound to any specific interface and is operational at all times. To use this interface, ensure that the IP address is reachable through one of the VLAN interfaces. It will be routable from all external networks.

You must configure a loopback address if you are not using VLAN1 to connect the Mobility Master or managed device to the network. If you do not configure the loopback interface address, then the first configured VLAN interface address is selected. Generally, VLAN 1 is the factory default setting, and thus, becomes the IP address.

## In the WebUI

1. In the **Mobility Master** or **Managed Network** node hierarchy, navigate to the **Configuration > System > General** page.
2. Expand the **Loopback Interface** section.
3. Enter an address into the **IPv4 Address** or **IPv6 Address** field, as required.
4. Click **Submit**.
5. Click **Pending Changes**.
6. In the **Pending Changes** window, select the check box and click **Deploy changes**.



---

If you are use the loopback IP address to access the WebUI, changing the loopback IP address will result in loss of connectivity. It is recommended that you use one of the VLAN interface IP addresses to access the WebUI.

---

7. In the **Mobility Master** node hierarchy, navigate to the **Maintenance > Software Management > Reboot** page to reboot Mobility Master and apply the loopback IP address update.
8. Click **Yes** to save the configuration.
9. Click **Reboot**.
10. **Mobility Master** boots up with the changed loopback IP address.

## In the CLI

Use the following commands:

```
(host) [mynode] (config) #interface loopback ip address <ipaddr>
```

## Configuring Static IP Routes

The following procedures configure a static IP route (such as a default route) on Mobility Master.

### In the WebUI

1. In the **Mobility Master** node hierarchy, navigate to the **Configuration > Interfaces > IP Routes** page.
2. Expand the **IP Routes** section.
3. Click **+** to add a static route to a destination network or host.
4. Select the **IP Version**.
5. Enter the **Destination IP address** and **Destination network mask** (255.255.255.255 for a host route)
6. Select a forwarding setting:
  - **Using Forwarding Router Address:** Enter the nexthop IP address in dotted decimal format (A.B.C.D). Optionally, enter the distance metric (cost) for this route. The cost prioritizes routing to the destination. The lower the cost, the higher the priority.
  - **Using IPsec Name Map:** Enter the IPsec map name to use a static IPsec route map.
  - **Using Null Interface:** Designate a null interface.
7. Enter the **Next hop IP address** and **Cost**.
8. Click **Submit**.
9. Click **Pending Changes**.

10. In the **Pending Changes** window, select the check box and click **Deploy changes**.

## In the CLI

Use the following example:

```
(host) [mynode] (config) #ip route <destip> <destmask> {ipsec <name> [<cost>]|null <0-0>|<nexthop> [<cost>]}
```

## Configuring GRE Tunnels

Mobility Master supports Generic Routing Encapsulation (GRE) tunnels between managed device and other network devices that support GRE tunnels.

This section contains the following information:

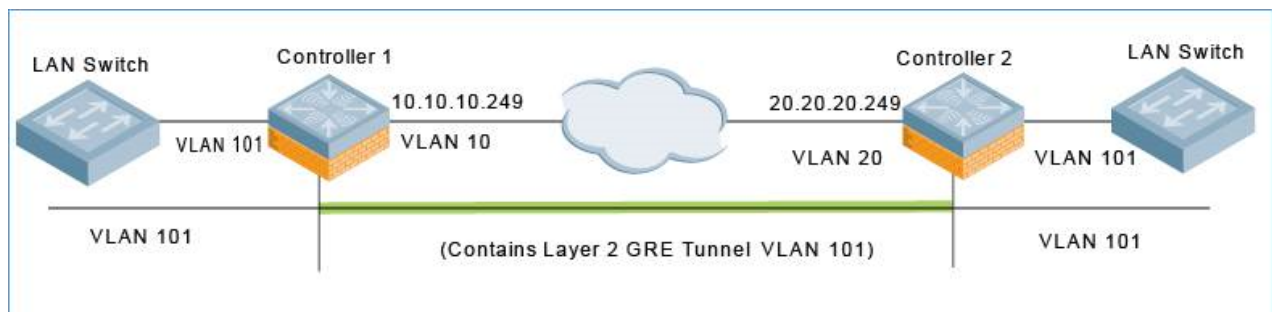
- [About Layer-2 GRE Tunnels](#)
- [About Layer-3 GRE Tunnels](#)
- [Configuring a Layer-2 GRE Tunnel](#)
- [Configuring a Layer-3 GRE Tunnel for IPv4 or IPv6](#)
- [Directing Traffic into the GRE Tunnel](#)
- [Configuring Tunnel Keepalives](#)

### About Layer-2 GRE Tunnels

Layer-2 GRE tunnels allow you to have the same VLAN in multiple locations (separated by a Layer-3 network) and be connected. The forwarding method for a Layer-2 GRE tunnel is bridging.

However, the drawback of using Layer-2 GRE tunnels is that all broadcasts are flooded through the tunnel, adding traffic load to the network and the managed devices.

**Figure 15** *Layer-2 GRE Tunnel*



The traffic flow illustrated by [Figure 15](#) is as follows:

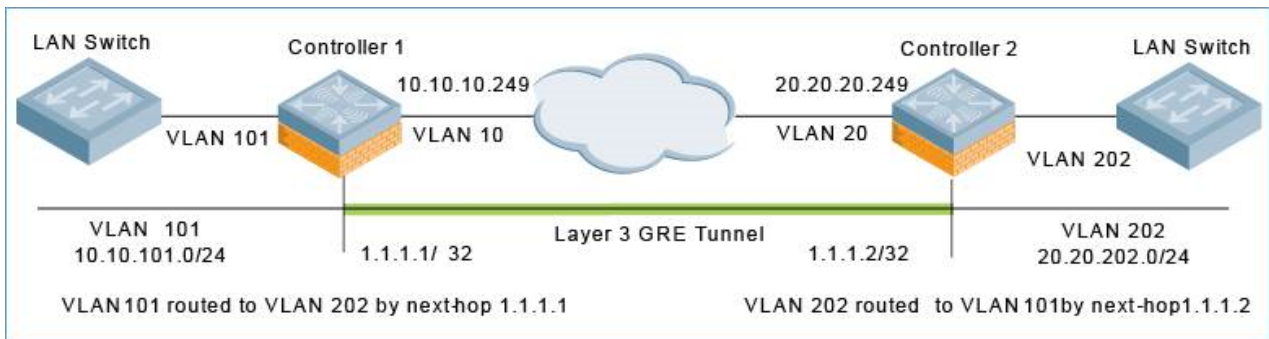
1. The frame enters the source managed device (Controller-1) on VLAN 101.  
The frame is bridged through Controller-1 into the Layer-2 GRE tunnel.
2. The frame is encapsulated in a GRE packet.
3. The GRE packet enters the network on VLAN 10, is routed across the network to the destination managed device (Controller-2), and then exits the network on VLAN 20.  
The source IP address of the GRE packet is the IP address of the interface in VLAN 10 in Controller 1.
4. The frame is de-encapsulated and bridged out of the destination managed device (Controller-2) on VLAN 101.



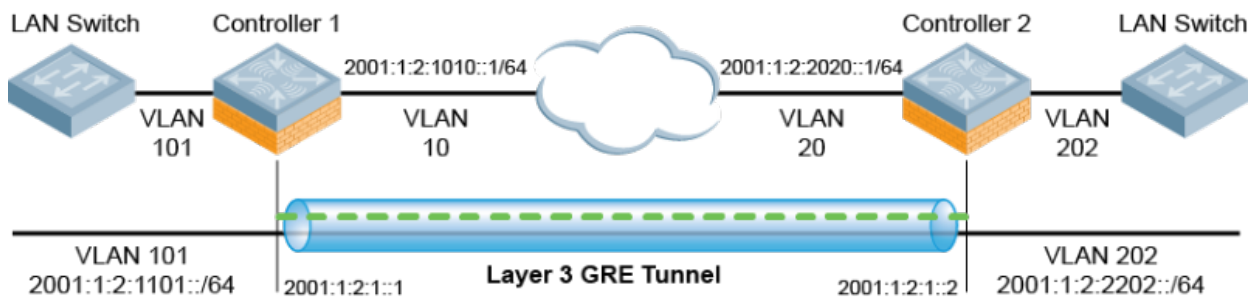
## About Layer-3 GRE Tunnels

The benefit of Layer-3 GRE tunnels is that broadcasts are not flooded through the tunnel, so there's less wasted bandwidth and less load on the managed devices. The forwarding method for a Layer-3 GRE tunnel is routing. By default, GRE tunnels are in IPv4 Layer-3 mode.

**Figure 16** IPv4 Layer-3 GRE Tunnel



**Figure 17** IPv6 Layer-3 GRE Tunnel



IPv6 encapsulated in IPv4 and IPv4 encapsulated in IPv6 are not supported. The only Layer-3 GRE modes supported are IPv4 encapsulated in IPv4 and IPv6 encapsulated in IPv6.

## Layer-3 Tunnel Traffic Flow

The traffic flow illustrated by [Figure 16](#) and [Figure 17](#) is as follows:

1. The frame enters the source managed device (Controller-1) on VLAN 101.  
The IP packet within the frame is routed through Controller-1 into the Layer-3 GRE tunnel.
2. The IP packet is encapsulated in a GRE packet.
3. The GRE packet enters the network on VLAN 10, is routed across the network to destination managed device (Controller-2), and then exits the network on VLAN 20.  
The source IP address of the GRE packet is the IP address of the interface in VLAN 10 in Controller 1.
4. The IP packet is de-encapsulated and routed out of the destination managed device (Controller-2) on VLAN 202.

## Limitations for Static IPv6 Layer-3 Tunnels

ArubaOS does not support the following functions for static IPv6 Layer-3 GRE tunnels:

- IPv6 Auto-configuration and IPv6 Neighbor Discovery mechanisms do not apply to IPv6 GRE tunnels.
- The tunnel encapsulation limit and Maximum Transmission Unit (MTU) discovery options are not supported on IPv6 GRE tunnels.

## Configuring a Layer-2 GRE Tunnel

### In the WebUI

To configure a Layer-2 GRE tunnel for a source managed device and destination managed device via the WebUI:

1. In the **Managed Network** node hierarchy, navigate to **Configuration > Interfaces > GRE Tunnels**.
2. Create a new GRE tunnel by clicking **+** below the **GRE Tunnel** table, or edit an existing GRE tunnel by selecting an entry from the **GRE Tunnel** table.
3. Enter the corresponding GRE tunnel values for this managed device.
4. (Optional) Select **Enable** from the **Enable heartbeats** drop-down list to enable tunnel keepalive heartbeats. For more information on this feature, see [Configuring Tunnel Keepalives on page 110](#)
5. Click **Submit**.
6. Click **Pending Changes**.
7. In the **Pending Changes** window, select the check box and click **Deploy changes**.
8. Next, access the destination managed device and navigate to **Configuration > Interfaces > GRE Tunnels**.
9. Select the tunnel ID of interest from the **GRE Tunnel** table.
10. Use the edit screen to configure the destination managed device.
11. (Optional) Select **Enable** from the **Enable heartbeats** drop-down list to enable tunnel keepalive heartbeats.
12. Click **Submit**.
13. Click **Pending Changes**.
14. In the **Pending Changes** window, select the check box and click **Deploy changes**.

### In the CLI

The following command example configures a Layer-2 GRE tunnel:

Referring to [Figure 15](#), the following are the required configurations to create the Layer-2 GRE tunnel between controllers named Controller-1 and Controller-2:

#### IPv4 Controller-1 Configuration

```
(host) [mynode] (config) # interface tunnel 102
description "IPv4 Layer-2 GRE 102"
trusted
tunnel
mode gre 1
source vlan 10
destination 20.20.20.249
keepalive
vlan 101
```

#### IPv4 Controller-2 Configuration

```
(host) [mynode] (config) # interface tunnel 202
description "IPv4 Layer-2 GRE 202"
trusted
tunnel
mode gre 1
source vlan 20
destination 10.10.10.249
keepalive
vlan 101
```

The following command example configures a Layer-2 GRE tunnel for IPv6:

## IPv6 Controller-1 Configuration

```
(host) [mynode] (config) # interface tunnel 102
description "IPv6 Layer-2 GRE 202"
trusted
tunnel
  destination ipv6 2001:1:2:2020::1
  keepalive
  mode gre 1
  source ipv6 vlan 10
  vlan 101
```

## IPv6 Controller-2 Configuration

```
(host) [mynode] (config) # interface tunnel 202
description "IPv6 Layer-2 GRE 202"
trusted
tunnel
  destination ipv6 2001:1:2:1010::1
  keepalive
  mode gre 1
  source ipv6 vlan 20
  vlan 101
```

## Configuring a Layer-3 GRE Tunnel for IPv4 or IPv6

### In the WebUI

The following steps describe the procedure configure an IPv4 Layer-3 GRE tunnel for Controller-1 and Controller-2 via the WebUI.

1. In the source **Managed Network** node hierarchy, navigate to **Controller-1 > Configuration > Interfaces > GRE Tunnels**.
1. Navigate to **Configuration > Interfaces > GRE Tunnels**. The **GRE Tunnels** page is displayed.
2. Create a new GRE tunnel by clicking + below the GRE Tunnel table, or edit an existing GRE tunnel by selecting that entry in the GRE Tunnel table. The **GRE Tunnel** configuration options appear.
3. Click the IP Version drop-down list and select IPv4 or IPv6.
4. Enter the corresponding GRE tunnel values for the controller.
  - To configure an IPv4 GRE tunnel , use values for Controller-1 based on the network shown in [Figure 16](#).
  - To configure an IPv6 GRE tunnel , use values for Controller-1 based on the network shown in [Figure 17](#).



---

If a VLAN interface has IPv6 addresses configured, one of them is used as the tunnel source IPv6 address. If the selected IPv6 address is deleted from the VLAN interface, then the tunnel source IP address is reconfigured with the next available IPv6 address.

---

5. (Optional for IPv4 or IPv6 GRE Tunnels) Select **Enable Heartbeats** to enable tunnel keepalive heartbeats. For more information on this feature, see [Configuring Tunnel Keepalives on page 110](#)
6. Click **Submit**.
7. Click **Pending Changes**.
8. In the **Pending Changes** window, select the check box and click **Deploy changes**
9. Next, log into Controller-2 and navigate to **Configuration > Interfaces > GRE Tunnels**.
10. Create a new GRE tunnel by clicking + below the GRE Tunnel table, or edit an existing GRE tunnel by selecting that entry in the GRE Tunnel table. The **GRE Tunnel** configuration options appear.
11. Enter the corresponding GRE tunnel values for this controller.
  - To create an IPv4 L3 GRE tunnel, use the values for Controller-2 as shown in [Figure 16](#).

- To create an IPv6 L3 GRE tunnel, use the values for Controller-2 as shown in [Figure 17](#).
- (Optional for IPv4 or IPv6 GRE Tunnels) Select **Enable Heartbeats** to enable tunnel keepalive heartbeats.
  - Click **Submit**.
  - Click **Pending Changes**.
  - In the **Pending Changes** window, select the check box and click **Deploy changes**.

## In the CLI

The following command examples configure an IPv4 Layer-3 GRE tunnel for IPv4 between two controllers. Referring to [Figure 16](#), the following are the required configurations to create the IPv4 Layer-3 GRE tunnel between controllers named Controller-1 and Controller-2:

### IPv4 Controller-1 Configuration

```
(host) [mynode] (config) # interface tunnel 104
description "IPv4 L3 GRE 104"
trusted
tunnel
mode gre ip
ip address 1.1.1.1 255.255.255.255
source vlan 10
destination 20.20.20.249
```

### IPv4 Controller-2 Configuration

```
(host) [mynode] (config) # interface tunnel 204
description "IPv4 L3 GRE 204"
trusted
tunnel
mode gre ip
ip address 1.1.1.2 255.255.255.255
source vlan 20
destination 10.10.10.249
```

The following command example configures a Layer-3 GRE tunnel for IPv6:

### IPv6 Controller-1 Configuration

```
(host) [mynode] (config) # interface tunnel 106
description "IPv6 Layer-3 GRE 106"
trusted
tunnel
tunnel mode gre ipv6
ipv6 address 2001:1:2:1::1
tunnel source ipv6 vlan 10
tunnel destination ipv6 2001:1:2:2020::1
```

### IPv6 Controller-2 Configuration

```
(host) [mynode] (config) # interface tunnel 206
description "IPv6 Layer-3 GRE 206"
trusted
tunnel
tunnel mode gre ipv6
ipv6 address 2001:1:2:1::2
tunnel source ipv6 vlan 20
tunnel destination ipv6 2001:1:2:1010::1
```

## Directing Traffic into the GRE Tunnel

You can direct traffic into a GRE tunnel by configuring a *Static route*, which directs traffic to the IP address of the tunnel, or a *Firewall policy (session-based ACL)*, that redirects traffic to the specified tunnel ID.

### About Configuring Static Routes

You can configure a static route that specifies the IP address of a tunnel as the next-hop for traffic for a specific destination. See [Configuring Static IP Routes on page 103](#) for detailed information on how to configure a static route.



---

While redirecting traffic into a Layer-3 GRE tunnel via a static route, be sure to use the tunnel IP address of the controller as the next-hop, instead of providing the tunnel IP address of the destination controller.

---

Referring to [Figure 16](#), the following are examples of the required static route configurations to direct traffic into the IPv4 Layer-3 GRE tunnel. for Controller-1 and Controller-2:

- For the controller named Controller-1:  

```
(host) [mynode] (config) # ip route 20.20.202.0 255.255.255.0 1.1.1.1
```
- For the controller named Controller-2:  

```
(host) [mynode] (config) # ip route 10.10.101.0 255.255.255.0 1.1.1.2
```

### Configuring a Firewall Policy Rule

You can configure a firewall policy rule to redirect selected traffic into a GRE tunnel.

Traffic redirected by a firewall policy rule is *not* forwarded to a tunnel that is “down” (see the next section, [Configuring Tunnel Keepalives](#), for more information on how GRE tunnel status is determined).

#### From the WebUI

To direct traffic into a GRE tunnel via a firewall policy via the WebUI:

1. On the **Managed Network** node hierarchy, navigate to the **Configuration > Roles & Policies > Policies** page.
2. Create a new firewall policy by clicking + below the **Policies** table. The **Add Policy** popup window appears.
3. Enter the **Policy Name**.
4. For **Policy Type**, specify **Session** (the default).
5. Click **Submit**.
6. Click **Pending Changes**.
7. In the **Pending Changes** window, select the check box and click **Deploy changes**
8. To create a new policy rule for that policy, select the new policy in the Policies table, then scroll to the **Add** table (below the **Policies** table) section and click +.
  - a. Select the **Rule Type** and click **OK**.
  - b. Specify the **IP Version**.
  - c. For **Action**, select **Permit** or **Deny**.
  - d. Configure any additional settings.
9. Click **Submit**.
10. Click **Pending Changes**.
11. In the **Pending Changes** window, select the check box and click **Deploy changes**

## In the CLI

To direct traffic into a GRE tunnel via a firewall policy (session-based ACL) via the CLI, use the following command:

```
(host) [mynode] (config) #ip access-list session <name>
    <source> <destination> <service> redirect tunnel <id>
```

## Configuring Tunnel Keepalives

The controller determines the status of a GRE tunnel by sending periodic keepalive frames on the Layer-2 or Layer-3 GRE tunnel. When you enable tunnel keepalives, the tunnel is considered “down” when the keepalives fail repeatedly.

If you configure a firewall policy rule to redirect traffic to the tunnel, traffic is not forwarded to the tunnel until it is "up." When the tunnel comes up or goes down, an SNMP trap and logging message is generated. The remote endpoint of the tunnel does not need to support the keepalive mechanism.

The controller sends keepalive frames at 60-second intervals by default and retries keepalives up to three times before the tunnel is considered down. You can change the default values of the intervals:

- For the **interval**, specify a value between 1 and 86400 seconds.
- For the **retries**, specify a value between 0 and 1024.
- To interoperate with Cisco network devices, use the **cisco** option.

## In the WebUI

To configure keepalives (Heartbeats) via the WebUI:

1. In the **Managed Network** node hierarchy, navigate to the **Configuration > Interfaces > GRE Tunnels** page.
2. Locate the tunnel ID for which you are enabling keepalives, and select it. The Edit GRE Tunnel screen appears.
3. To enable tunnel keepalives and display the **Heartbeat interval (secs)** and **Heartbeat Retries** fields, select **Enabled**.
  - a. Specify a value for **Heartbeat interval (secs)**.  
The default value is 10 seconds.
  - b. Specify a value for **Heartbeat Retries**.  
The default value is 3 retries.
4. Click **Submit**.
5. Click **Pending Changes**.
6. In the **Pending Changes** window, select the check box and click **Deploy changes**

## In the CLI

To configure the keepalive heartbeats, use the following commands:

```
(host) [md] (config) #interface tunnel id
    tunnel keepalive [<interval> <retries>] [cisco]
```

## GRE Tunnel Groups

ArubaOS supports redundancy of Generic Routing Encapsulation (GRE) tunnels for both Layer-2 and Layer-3 GRE tunnels. This feature enables automatic redirection of the user traffic to a standby tunnel when the primary tunnel goes down.

## GRE Tunnel Group Overview

A tunnel group is identified by a name or number. You can add multiple tunnels to a tunnel group. The order of the tunnels defined in the tunnel-group configuration specifies their standby precedence. The first member of the tunnel-group is the *primary tunnel*.

A GRE tunnel group combines two tunnels created on a managed device, where one tunnel is active and the other tunnel is the standby. Traffic forwarding can occur on the active tunnel, and the standby tunnel can become active once the active tunnel is down. When the first tunnel fails, the second tunnel carries the traffic. The third tunnel in the tunnel-group takes over if the second tunnel also fails. In the meantime, if the first tunnel comes up, it becomes the most eligible standby tunnel.

You can also enable or disable preemption as part of the tunnel-group configuration. Preemption is enabled by default. This **preemptive-failover** option automatically redirects the traffic whenever it detects an active tunnel with a higher precedence in the tunnel group. When preemption is disabled, the traffic gets redirected to a higher precedence tunnel only when the tunnel carrying the traffic fails.

When creating a tunnel group, keep in mind the following:

- When a tunnel is added to the tunnel group, the tunnel is used for data traffic only if it is the active tunnel in the group.
- Standby tunnels do not carry any data traffic. However, all tunnels in the group continue to send and receive keepalive packets.
- Only one type of tunnel can be placed into a tunnel group—either Layer-2 or Layer-3. That is, you can't have a tunnel group consisting of both Layer-2 and Layer-3 tunnels.
- The default value of tunnel group type is Layer-3.
- All tunnels in a Layer-2 tunnel group must be tunneling the same VLAN.
- A Layer-2 tunnel can only be part of one tunnel group.
- The ArubaOS Layer-2 tunnel-group is not interoperable with other vendors. You must set up Layer-2 tunnel groups between Aruba devices only.

## Configuring Tunnel Groups

### In the WebUI

To configure a Layer-2 or Layer-3 tunnel group using the WebUI:

1. In the **Mobility Master** node hierarchy, navigate to **Configuration > Interfaces > GRE Tunnels**.
2. Click + below the **Tunnel Group** table.
3. Specify a name for the tunnel-group in the **Tunnel Group Name** field.
4. In the **Tunnel Group Members** text box, click + to add one or more tunnel IDs.
5. Select the IDs and click **OK**.
6. To enable preemption, click the **Enable Preemptive-Failover Mode** drop-down list and select **Enabled**. This option is enabled by default.
7. In the **Mode** section, identify the the tunnel group type as a layer-2 or layer-3 group.
8. Click **Submit**.
9. Click **Pending Changes**.
10. In the **Pending Changes** window, select the check box and click **Deploy changes**.

### In the CLI

Use the following commands to configure a Layer-2 or Layer-3 tunnel group using the CLI:

```
(host) [mynode] (config) tunnel-group <tungrpname>
(host) [mynode] (config-tunnel-group) #
```

```
mode {L2|L3}
preemptive-failover
tunnel <tunnel-id>
```

## Jumbo Frame Support

Jumbo frames are the data frames that are larger than 1500 bytes and includes the Layer 2 header and Frame Check Sequence (FCS). Jumbo frames functionality can be configured on 7200 Series controllers to support up to 9216 bytes of payload.

In centralized deployments, frames that are more than 1500 bytes in size are generated from the AP to the managed device during encryption and enabling AMSDU. Therefore, whenever the AP associates to the managed device, jumbo frames are used to get the highest network performance. If this functionality is not supported, the data frames gets fragmented, which reduces the overall throughput of the network and makes the network slow.



---

ArubaOS supports jumbo frames between 11ac APs and 7200 Series controllers only.

---

You can enable the jumbo frame support in the following scenarios:

- **Tunnel node:** In a tunneled node deployment, the wired clients connected on the tunneled nodes can send and receive the jumbo frames.
- **L2/L3 GRE tunnels:** When you establish a GRE tunnel between two managed devices, the clients on one managed device can send and receive jumbo frames from the clients on the other managed device on enabling jumbo frames.
- **Between wired clients:** In a network where clients connect to the managed device with jumbo frames enabled ports can send and receive the jumbo frames.
- **Wi-Fi tunnel:** A Wi-Fi tunnel can support an AMSDU jumbo frame for an AP (The maximum MTU supported is up to 9216 bytes).

### Limitations for Jumbo Frame Support

This release of ArubaOS does not support the jumbo frames for the following scenarios:

- IPsec, IPIP, and xSec.
- IPv6 fragmentation/reassembly.

### Configuring Jumbo Frame Support

You can use the CLI to configure the jumbo frame support.

To enable the jumbo frame support globally and to configure the MTU value:

```
(host) [mynode] (config) #firewall jumbo mtu <1789-9216>
```

You can configure the MTU value between 1789-9216. The default MTU value is 9216.

To enable jumbo frame support on a port channel:

```
(host) [mynode] (config) #interface port-channel <id> jumbo
```

To enable jumbo frame support on a port:

```
(host) [mynode] (config) #interface gigabitethernet <slot>/<module>/<port> jumbo
```

### Viewing the Jumbo Frame Support Status

Execute the following command to view the global status of the jumbo frame support:



```
(host) [mynode] #show firewall
```

Execute the following command to view the jumbo frame status on a port:

```
(host) [mynode] #show interface gigabitethernet <slot>/module/<port>
```

Execute the following command to view the jumbo frame status on a port channel:

```
(host) [mynode] #show interface port-channel <id>
```

## PVST+ (Per-VLAN Spanning Tree Plus)

PVST+ (Per-VLAN Spanning Tree Plus) provides load-balancing of VLANs across multiple ports, resulting in optimal usage of network resources. PVST+ also ensures interoperability with industry-accepted PVST+ protocols.



---

PVST+ is disabled by default.

---

### Understanding PVST+ Interoperability and Best Practices

The interoperability between RSTP and PVST+ includes:

- When the access port on the managed device and the trunk port terminate on one Layer 2 switch running PVST+, PVST+ will send untagged STP BPDUs on the access port; it also transmits untagged STP BPDUs (in addition to the other PVST+ BPDUs) on the native VLAN trunk port. If the Aruba managed device is the root, it will detect a loop on the native VLAN.



---

If PVST+ is not on the managed device, best practices recommend disabling RSTP on the Aruba managed device to avoid a looping issue.

---

- For VLAN load balancing when managed devices are connected to armed mode, the VLAN priorities on two ports and bridge priorities must be configured so that one set of VLANs are active on one link, and the other set of VLANs are active on the other link.
- Supported instances include: 64 on the 7000 Series and 7200 Series controllers.

### Enabling PVST+ in the WebUI

1. In the **Mobility Master** node hierarchy, navigate to **Configuration > Interfaces > VLANs** and select a VLAN with one or more active interfaces in the **VLANs** table.
2. In the **Port Members** table, select the **More** option.
3. Expand the **Spanning Tree** section, and enable PVST mode.
4. Click **Submit**.
5. Click **Pending Changes**.
6. In the **Pending Changes** window, select the check box and click **Deploy changes**.

### Enabling PVST+ in the CLI

PVST+ is disabled by default. Enable PVST+, ensure a VLAN instance is configured, and then configure PVST+.

1. Enable PVST+:

```
(host) [mynode] (config) #spanning-tree mode rapid-pvst
```

2. Configure PVST+ forward time; the following command sets the time VLAN 2 spends in the listening and learning state (3 seconds):

```
(host) [mynode] (config) #spanning-tree vlan 2 forward-time 3
```

3. Configure PVST+ hello time; the following command sets the time VLAN 2 waits to transmit BPDUs to four seconds:

```
(host) [mynode] (config) #spanning-tree vlan 2 hello-time 4
```

4. Configure PVST+ max age; the following command sets the time VLAN 2 waits to receive a hello packet to 30 seconds:

```
(host) [mynode] (config) #spanning-tree vlan 2 max-age 30
```

5. Configure PVST+ priority: the following command sets the VLAN 2 priority to 10, making it more likely to become the root bridge:

```
(host) [mynode] (config) #spanning-tree vlan 2 priority 10
```

6. Configure PVST+ on a range of VLANs using the VLAN IDs (coma separated or hyphen separated):

```
(host) [mynode] (config) #spanning-tree vlan range 2-6,11
```

## Rapid Spanning Tree Protocol (RSTP)

The ArubaOS implementation of Rapid Spanning Tree Protocol (RSTP) is as specified in 802.1w, with backward compatibility to legacy Spanning Tree (STP) 802.1D. RSTP takes advantage of point-to-point links and provides rapid convergence of the spanning tree. RSTP is enabled by default on all Aruba managed devices.

### RSTP Overview

The ArubaOS RSTP implementation interoperates with PVST (Per VLAN Spanning Tree 802.1D) and Rapid-PVST (802.1w) implementation on industry-standard routers/switches. Aruba only supports global instances of STP and RSTP. Therefore, the ports on industry-standard routers/switches must be on the default or untagged VLAN for interoperability with Aruba managed devices.

ArubaOS supports RSTP on the following interfaces:

- FastEthernet IEEE 802.3: fastethernet
- GigabitEthernet IEEE 802.3: gigabitethernet
- Port Channel ID: port-channel

Since RSTP is backwards compatible with STP, it is possible to configure both bridges in the same network. However, such mixed networks may not always provide rapid convergence. RSTP provides rapid convergence when interfaces are configured as either:

- **Edge ports:** These are the interfaces/ports connected to hosts. These interfaces are immediately moved to the forwarding state. In this mode, an interface forwards frames by default until it receives a BPDU (Bridge Protocol Data Units), indicating that it should behave otherwise. It does not go through the Listening and Learning states.
- **Point-to-Point links:** These are the interfaces/ports connected directly to neighboring bridges over a point-to-point link. RSTP negotiates with the neighbor bridge for rapid convergence/transition only when the link is point-to-point.

**Table 21: Port State Comparison**

STP (802.1d) Port State	RSTP (802.1w) Port State
Disabled	Discarding
Blocking	Discarding
Listening	Discarding
Learning	Learning
Forwarding	Forwarding

In addition to port state, RSTP introduces port roles for all the interfaces (see [Table 22](#)).

**Table 22: Port Role Descriptions**

RSTP (802.1w) Port Role	Description
Root	The port that receives the best BPDU on a bridge.
Designated	The port can send the best BPDU on the segment to which it is connected.
Alternate	The port offers an alternate path, in the direction of root bridge, to that provided by bridge's root port.
Backup	The port acts as a backup for the path provided by a designated port in the direction of the spanning tree.

## Configuring RSTP

Use either the CLI or the WebUI to configure RSTP.

### In the WebUI

The RSTP port interface is designated as point-to-point, by default, in the existing port configuration screen.

1. In the **Mobility Master** node hierarchy, navigate to **Configuration > Interfaces > Ports**.
2. In the **Ports** table, click the port number for which you want to enable RSTP/STP features.
3. Select the **Show Advanced Options** link at the bottom of the **Ports** tab.
4. Scroll down to the **Spanning Tree** drop-down list and select **Enabled**.
5. (Optional) Define values for the following Spanning Tree configuration parameters:
  - **Cost:** Defines the RSTP interface path cost. The cost prioritizes routing to the destination. The lower the cost, the higher the priority.
  - **Priority:** Sets the interface's RSTP priority. The supported range is 0–255, and the default value is 128.
  - **Port Fast:** Changes from blocking to forwarding mode, enabling forwarding of traffic from the interface.
  - **Point-to-Point:** Sets the interface as a point-to-point link.

6. Click **Submit**.
7. Click **Pending Changes**.
8. In the **Pending Changes** window, select the check box and click **Deploy changes**.

## In the CLI

Change the default configurations using the following commands in the command-line interface:

```
(host) [mynode] (config) #interface gigabitethernet <slot>/<module>/<port>
(host) [mynode] (config-if) #spanning-tree
    cost <value>
    point-to-point
    port-priority <value>
    portfast
```

The following commands can be used to view settings and troubleshoot RSTP issues:

- The **show spantree** command displays the root and bridge information, verifying that they are correct. The port/interface information (e.g. state, role, etc.) is also displayed to make sure that the state and role information correspond with each other. For more details and examples on the **show spantree** command, refer to **show spantree** in the *ArubaOS CLI Reference Guide*.
- The **show spanning-tree interface** command (config-if mode) displays Tx/Rx BPDU counters. For example, if a port's role is "designated," it only transmit BPDUs but does not receive any. In this case, the Tx counter continues to increase in increments while the Rx counter remains the same. This is reversed when a port's role is "root/alternate/backup". For more details and examples on the **show spanning-tree interface** command, refer to **show spanning-tree** in the *ArubaOS CLI Reference Guide*.

## PortFast and BPDU Guard for Spanning Tree

The PortFast and Bridge Protocol Data Unit (BPDU) Guard features enhance network reliability, manageability, and security for Layer-2 Spanning Tree Protocol (STP).

Some devices and local stacks running on systems/workstations are capable of generating potential STP BPDUs that cause Denial of Service (DOS) attacks. PortFast and BPDU Guard features provide stability and security for network topologies to prevent such attacks, and can be applied either independently or together.

### PortFast

The PortFast feature is introduced to avoid network connectivity issues. These issues are caused by delays in STP enabled ports moving from blocking-state to forwarding-state after transitioning from the listening and learning states. STP enabled ports that are connected to devices such as a single switch, workstation, or a server can access the network only after passing all these STP states. Some applications need to connect to the network immediately, else they will timeout.

Enabling the PortFast feature causes a switch or a trunk port to enter the STP forwarding-state immediately or upon a linkup event, thus bypassing the listening and learning states. The PortFast feature is enabled at a port level, and this port can either be a physical or a logical port. When PortFast feature is enabled on a switch or a trunk port, the port immediately transitions to the STP forwarding state.

Though PortFast is enabled the port still participates in STP. If the port happens to be part of topology that could form a loop, the port eventually transitions into STP blocking mode. PortFast is usually configured on an edge port, which means the port should not receive any STP BPDUs. If the port receives any STP BPDU, it moves back to normal/regular mode and will participate in the listening and learning states.

In most deployments, edge ports are access ports. However, in this scenario there are no restrictions in enabling the PortFast feature. The mode of the port changes from PortFast to non-PortFast when the port receives a STP BPDU. To re-enable this feature on a port, run the **shut** command followed by a **no-shut** command at the interface/port level.



---

Configuring PortFast on a non-edge port can cause instability to the STP topology.

---

## BPDU Guard

BPDU Guard feature protects the port from receiving STP BPDUs, however the port can transmit STP BPDUs. When a STP BPDU is received on a BPDU Guard enabled port, the port is shutdown and the state of the port changes to **ErrDis** (Error-Disable) state. The port remains in the **ErrDis** state until the port status is manually changed by using the configuration command **shut** followed by a **no-shut** applied on the interface. In most deployments, BPDU Guard feature is configured over the PortFast enabled STP ports, but in this implementation the BPDU Guard feature can be enabled on any of the STP ports, with or without PortFast feature being enabled on these ports.



---

It is recommended not to enable the BPDU Guard feature on a trunk port that forms the STP topology.

---

## Scenarios Supported on PortFast and BPDU Guard

PortFast and BPDU Guard features are applied at the port/interface level. These features can also be applied in the following scenarios:

- RSTP and PVST modes
- Access and Trunk ports
- Physical and Logical ports

In the global RSTP mode, there is only one RSTP instance running in the entire Mobility Master. If the port that is enabled with PortFast and BPDU Guard receives any STP BPDU, it affects all ports, as the global RSTP runs on a port basis.

In the PVST mode, there can be multiple instances of RSTP running, as they are based per VLAN. Though it is based per VLAN, it will still behave in the same way as it does in the global RSTP mode. For example, if there are five VLANs and each VLAN has a separate RSTP instance running, then any STP BPDU received on any of these five ports effects all ports.

If an STP BPDU is received from any one of the five RSTP instances running, the port that is enabled with BPDU Guard shuts down and goes to **ErrDis** state. In other words, both PortFast and BPDU Guard features are applied on a port basis for both global RSTP and PVST modes, even though the PVST runs on a per VLAN basis.

## Enabling PortFast and BPDU Guard on a Port

The following section guides you to enable the PortFast and BPDU Guard features on a port. BPDU Guard is configurable only via the command-line interface.

### In the Web UI

Follow the steps below to enable PortFast features on a port using the WebUI:

1. In the **Mobility Master** node hierarchy, navigate to **Configuration > Interfaces > Ports**.
2. In the **Ports** table, click the port number for which you want to enable PortFast and BPDU Guard.
3. Select the **Show Advanced Options** link at the bottom of the **Ports** tab .
4. Select the **PortFast** check box.

5. Click **Submit**.
6. Click **Pending Changes**.
7. In the **Pending Changes** window, select the check box and click **Deploy changes**.



---

It is recommended to enable PortFast only on access port types. However, PortFast can be enabled on the trunk ports by selecting the **Trunk** check box in the WebUI.

---

## In the CLI

Execute the following commands at the command prompt to enable PortFast and BPDU Guard:

```
(host) [mynode] (config) #interface gigabitinternet <slot>/<module>/<port>
(host) [mynode] (config-if) #spanning-tree portfast
(host) [mynode] (config-if) #spanning-tree bpduguard
```

To disable PortFast

```
(host) [mynode] (config-if) #no spanning-tree portfast
(host) [mynode] (config-if) #no spanning-tree bpduguard
```

Execute the following command to enable PortFast on trunk ports:

```
(host) [mynode] (config) #interface gigabitethernet <slot>/<module>/<port>
(host) [mynode] (config-if) #spanning-tree portfast trunk
```

Execute the following show command to display the status of the STP ports ,

```
(host) [mynode] (config-if) #show spanning-tree interface gigabitethernet
<slot>/<module>/<port>
```

## Link Layer Discovery Protocol

Link Layer Discovery Protocol (LLDP), defined in the IEEE 802.1AB standard, is a Layer 2 protocol that allows network devices to advertise their identity and capabilities on a LAN. ArubaOS supports a simple one-way neighbor discovery protocol with periodic transmissions of LLDP PDUs, allowing managed devices to advertise identity information and capabilities to other nodes on the network and store the information discovered about the neighbors.

### Getting Started with ArubaOS LLDP

This chapter describes ArubaOS LLDP features, and lists the procedures to configure an LLDP solution.

#### Learn more about LLDP Features

The [LLDP Overview on page 118](#) contains details about the ArubaOS implementation of the LLDP protocol, including supported TLVs, and known issues and limitations.

#### Configure and Monitor an LLLDP Solution

[Configuring and Monitoring LLDP on page 119](#) describes the commands to configure LLDP and monitor existing LLDP neighborhood data.

### LLDP Overview

LLDP supported devices use attributes known as TLVs to receive and send information such as configuration information, device capabilities, and device identity to their neighbors. These TLVs contain type, length, and value descriptions, use the destination MAC address 01:80:c2:00:00:0e, and are constrained to a local link. SNMP support is available for LLDP MIBs.

## Supported TLVs

ArubaOS supports the following basic management TLVs, all of which are enabled by default:

- MAC Phy configuration TLV
- Management address TLV
- Maximum frame size TLV
- Port-description TLV
- Port VLAN ID TLV
- System capabilities TLV
- System description TLV
- System name TLV
- VLAN name TLV

## LLDP-MED

LLDP-MED (media endpoint devices) is an extension to LLDP that supports interoperability between VoIP devices and other networking clients. LLDP-MED network policy discovery lets end-points and network devices advertise their VLAN IDs (for example, voice VLAN), priority levels, and DSCP values. ArubaOS supports a maximum of eight LLDP -MED Network Policy profiles.

Creating an LLDP MED network policy profile does not apply the configuration to any AP or AP interface or interface group. To apply the LLDP-MED network policy profile, you must associate it to an LLDP profile, then apply that LLDP profile to an AP wired port profile.

You can use the command, **ap lldp med-network-policy-profile** to define an LLDP MED network policy profile that defines DSCP values and L2 priority levels for a voice or video application.



---

When you use the default LLDP configuration, the **LLDP RX** and **LLDP TX** parameters are disabled. You must explicitly enable them for LLDP to work.

---

## Feature Restrictions and Limitations

- Inventory-management and Location TLVs are not currently supported.
- Aggregation-management and Power-management TLVs are not supported.
- Cisco Discovery Protocol (CDP) proprietary is not supported.
- The maximum number of neighbors that can be learned on the managed device (including all the per port neighbors) is 250.

## Configuring and Monitoring LLDP

Configure LLDP using the following commands in the command-line interface. For detailed information on the LLDP commands, refer to the **interface fastethernet | gigabitethernet**, **show lldp** and **show ap lldp** command in the ArubaOS *CLI Reference Guide*.

### Configuring LLDP

The following commands configure LLDP on a specific managed device interface.

```
(host) [mynode] (config) #interface gigabitethernet <slot>/<module>/<port>
(host) [mynode] (config-if) #lldp
    fast-transmit-counter <1-8>
    fast-transmit-interval <1-3600>
    med
    receive
    transmit
    transmit-hold <1-100>
```

```
transmit-interval <1-3600>
```



If you use the default LLDP configuration, the **transmit** and **Receive** parameters are disabled. You must explicitly enable them for LLDP to work.

## Configuring LLDP-MED

When you create an LLDP MED network policy profile, you must associate it to an LLDP profile, then apply that LLDP profile to an AP wired port profile.

The following commands create a LLDP MED network policy profile for streaming video applications and marks streaming video as high-priority traffic.

```
(host) [mynode] (config) #ap lldp med-network-policy-profile vid-stream
(host) [mynode] (AP LLDP-MED Network Policy Profile "vid-stream") #dscp 48

(host) [mynode] (AP LLDP-MED Network Policy Profile "vid-stream") #l2-priority 6
(host) [mynode] (AP LLDP-MED Network Policy Profile "vid-stream") #tagged
(host) [mynode] (AP LLDP-MED Network Policy Profile "vid-stream") #vlan 10
```

Next, the LLDP MED network policy profile is assigned to an LLDP profile, and the LLDP profile is associated with an AP wired-port profile.

```
(host) [mynode] (config) #ap lldp profile video1
(host) [mynode] (AP LLDP Profile "video1") #lldp-med-network-policy-profile vid-stream
(host) [mynode] (config) #ap wired-port-profile corp2

(host) [mynode] (AP wired port profile "corp2") #lldp-profile video1
```

## Monitoring LLDP Data and Configurations

The following show commands display aggregate and per-interface information about LLDP configurations and neighborhood data.

**Table 23: LLDP Show Commands**

Command	Description
<code>show lldp interface <b>gigabitethernet</b> &lt;slot&gt;/&lt;module&gt;/&lt;port&gt;</code>	Displays LLDP information for all interfaces, or include the optional <b>gigabitethernet &lt;slot&gt;/&lt;module&gt;/&lt;port&gt;</b> parameters to display LLDP information for a specific interface.
<code>show lldp neighbor <b>gigabitethernet</b> &lt;slot&gt;/&lt;module&gt;/&lt;port&gt; [details]</code>	This command displays information about LLDP peers, including the neighbor's name, MAC address and the capabilities of the peer to operate as a router, bridge, access point, phone or other network device. Include the optional <b>gigabitethernet &lt;slot&gt;/&lt;module&gt;/&lt;port&gt;</b> parameters to display detailed information about LLDP neighbors for a specific interface, or include the <b>details</b> parameter to display additional details about the device type, and LLDP-MED (Media Endpoint Discovery), if applicable.
<code>show lldp statistics <b>gigabitethernet</b> &lt;slot&gt;/&lt;module&gt;/&lt;port&gt;</code>	Displays information about LLDP TLVs sent and received on all interfaces, or include the optional <b>gigabitethernet &lt;slot&gt;/&lt;module&gt;/&lt;port&gt;</b> parameters to display LLDP TLV statistics for a specific interface.
<code>show ap lldp med-network-policy-profile</code>	Displays a list of LLDP-MED Network Policy profiles, or display the current configuration settings of an individual profile.



Command	Description
show ap lldp counters	Shows LLDP counters for a specific AP, or all APs sending or receiving LLDP Protocol Data Units (PDUs).
show ap lldp [<profile>]	Displays a list of LLDP-MED Network Policy profiles, or display the current configuration settings of an individual profile.

This chapter describes ArubaOS support for IPv6 features:

- [Understanding IPv6 Notation on page 122](#)
- [Enabling IPv6 on page 122](#)
- [Enabling IPv6 Support for Mobility Master and APs on page 123](#)
- [Filtering an IPv6 Extension Header on page 131](#)
- [Configuring a Captive Portal over IPv6 on page 132](#)
- [Working with IPv6 Router Advertisements on page 132](#)
- [RADIUS Over IPv6 on page 145](#)
- [TACACS Over IPv6 on page 146](#)
- [DHCPv6 Server on page 147](#)
- [IPsec Support](#)
- [Understanding ArubaOS Supported Network Configuration for IPv6 Clients on page 150](#)
- [Understanding IPv6 Exceptions and Best Practices on page 157](#)

## Understanding IPv6 Notation

The IPv6 protocol is the next generation of large-scale IP networks, it supports addresses that are 128 bits long. This allows  $2^{128}$  possible addresses (versus  $2^{32}$  possible IPv4 addresses).

Typically, the IP address assigned on an IPv6 host consists of a 64-bit subnet identifier and a 64-bit interface identifier. IPv6 addresses are represented as eight colon-separated fields of up to four hexadecimal digits each. The following are examples of IPv6 addresses:

```
2001:0000:0eab:DEAD:0000:00A0:ABCD:004E
```

The use of the "::" symbol is a special syntax that you can use to compress one or more group of zeros or to compress leading or trailing zeros in an address. The "::" can appear only once in an address.

For example, the address, 2001:0000:0dea:C1AB:0000:00D0:ABCD:004E can also be represented as:

```
2001:0:eab:DEAD:0:A0:ABCD:4E - leading zeros can be omitted
2001:0:0eab:dead:0:a0:abcd:4e - not case sensitive
2001:0:0eab:dead::a0:abcd:4e - valid
2001::eab:dead::a0:abcd:4e - invalid
```

IPv6 uses a "/" notation which describes the no: of bits in netmask, similar to IPv4.

```
2001:eab::1/128 - single Host
2001:eab::/64 - network
```

## Enabling IPv6

You must enable the IPv6 option on the managed device before using any of the IPv6 functions. You can use the `ipv6 enable` command to enable the IPv6 packet/firewall processing on the managed device. The IPv6 option is disabled by default.

You can also use the WebUI to enable the IPv6 option:

1. In the **Mobility Master** node hierarchy, navigate to the **Configuration > Services > Firewall** page.
2. Select the **Global Settings** accordion.

3. Select **Enabled** from **IPv6 enable** drop-down list to enable the IPv6 option.
4. Click **Submit**.
5. Click **Pending Changes**.
6. In the **Pending Changes** window, select the check box and click **Deploy changes**.

## Enabling IPv6 Support for Mobility Master and APs

This release of ArubaOS provides IPv6 support for a Mobility Master and access points. You can now configure the Mobility Master with an IPv6 address to manage the managed devices and APs. Both IPv4 and IPv6 APs can terminate on the IPv6 managed device. You can provision an IPv6 AP in the network only if the managed device interface is configured with an IPv6 address. An IPv6 AP can serve both IPv4 and IPv6 clients.



---

You must manually configure an IPv6 address on the managed device interface to enable IPv6 support.

---

You can perform the following IPv6 operations on the Mobility Master:

- [Configuring IPv6 Addresses on page 125](#)
- [Configuring IPv6 Static Neighbors on page 126](#)
- [Configuring IPv6 Default Gateway and Static IPv6 Routes on page 126](#)
- [Configuring Prefix Delegation on page 127](#)
- [Managing IP Addresses on page 128](#)
- [Configuring Multicast Listener Discovery on page 128](#)
- [Debugging IPv6 on page 130](#)
- [Provisioning an IPv6 AP on page 131](#)

You can also view the IPv6 statistics on the managed device using the following commands:

- `show datapath ip-reassembly ipv6` — View the IPv6 contents of the IP reassembly statistics table.
- `show datapath route ipv6` — View datapath IPv6 routing table.
- `show datapath route-cache ipv6` — View datapath IPv6 route cache.
- `show datapath tunnel ipv6` — View the tcp tunnel table filtered on IPv6 entries.
- `show datapath user ipv6` — View datapath IPv6 user statistics such as current entries, pending deletes, high water mark, maximum entries, total entries, allocation failures, invalid users, and maximum link length.
- `show datapath session ipv6` — View datapath IPv6 session entries and statistics such as current entries, pending deletes, high water mark, maximum entries, total entries, allocation failures, invalid users, and maximum link length.

Additionally, you can view the IPv6 AP information on the managed device using the following show commands:

- `show ap database`
- `show ap active`
- `show user`
- `show ap details ip6-addr`
- `show ap debug`

The following table lists IPv6 features:

**Table 24: IPv6 APs Support Matrix**

Features	Supported on IPv6 APs?
Forward Mode - Tunnel	Yes
Forward Mode - Decrypt Tunnel	No
Forward Mode - Bridge	No
Forward Mode - Split Tunnel	No
AP Type - CAP	Yes
AP Type - RAP	Yes
AP Type - Mesh Node	No
CPsec	Yes
Wired-AP/Secure-Jack	Yes
Fragmentation/Reassembly	Yes
MTU Discovery	Yes
Provisioning Through Static IPv6 Addresses	Yes
Provisioning Through IPv6 FQDN Master Name	Yes
Provisioning From WebUI	Yes
AP Boot by Flash	Yes
AP Boot by TFTP	No
WMM QoS	No
AP Debug and Syslog	Yes
ARM & AM	Yes
WIDS	Yes (Limited)
CLI Support for Users and Datapath	Yes

## Configuring IPv6 Addresses

You can configure IPv6 addresses for the management interface, VLAN interface, and the loopback interface of the Mobility Master and managed device. Upto three IPv6 addresses can be configured for each VLAN interface. The IPv6 address configured on the loopback interface or the first VLAN interface becomes the default IPv6 address of the device.



---

If only one IPv6 address is configured on the managed device, it becomes the default IPv6 address of the managed device. With this release of ArubaOS, you can delete this IPv6 address.

---

You can configure the IPv6 interface address using the WebUI or CLI. As per Internet Assigned Numbers Authority (IANA), a managed device supports the following ranges of IPv6 addresses:

- Global unicast—2000::/3
- Unique local unicast—fc00::/7
- Link local unicast—fe80::/10

### In the WebUI

#### To Configure Link Local Address

1. In the **Managed Device** node hierarchy, navigate to the **Configuration > Interfaces > VLANs** tab.
2. Select a Vlan from the **VLANs** table.
3. Select the corresponding Vlan Id from the **VLANs <Vlan name>** table.
4. Select the **IPv6** tab and enter the local link address in the **Local link address** field.
5. Click **Submit**.
6. Click **Pending Changes**.
7. In the **Pending Changes** window, select the check box and click **Deploy changes**.

#### To Configure Global Unicast Address

1. Select a Vlan from the **VLANs** table.
2. Select the corresponding Vlan Id from the **VLANs <Vlan name>** table.
3. Enter the prefix-length in the **Global unicast address 1** field and optionally, select the **EUI64Format** check box, if applicable.
4. Click **Submit**.
5. Click **Pending Changes**.
6. In the **Pending Changes** window, select the check box and click **Deploy changes**.

#### To Configure Loopback Interface Address

1. In the **Managed Network** node hierarchy, navigate to the **Configuration > System > General** tab.
2. Select **Loopback Interface** accordion and enter the loopback address in the **IPv6 address** field.
3. Click **Submit**.
4. Click **Pending Changes**.
5. In the **Pending Changes** window, select the check box and click **Deploy changes**.



---

You cannot configure the management interface address using the WebUI.

---

### In the CLI

To configure the link local address:

```
(host) [md] (config)#interface vlan <id>
(host) [md] (config-submode)#ipv6 address link-local <ipv6-address>
```

To configure the global unicast address:

```
(host) [md] (config)#interface vlan <id>
(host) [md] (config-submode)#ipv6 address <ipv6-prefix>/<prefix-length>
```

To configure the global unicast address (EUI 64 format):

```
(host) [md] (config)#interface vlan <id>
(host) [md] (config-submode)#ipv6 address <ipv6-prefix/prefix-length> eui-64
```

To configure the management interface address:

```
(host) [md] (config)#interface mgmt
(host) [md] (config-submode)#ipv6 address <ipv6-prefix/prefix-length>
```

To configure the loopback interface address:

```
(host) [md] (config)#interface loopback
(host) [md] (config-submode)#ipv6 address <ipv6-prefix>
```

## Configuring IPv6 Static Neighbors

You can configure a static neighbor on a VLAN interface either using the WebUI or the CLI.

### In the WebUI

1. In the **Managed Device** node hierarchy, navigate to the **Configuration > Interfaces > IPv6 Neighbors** tab.
2. Click **+** and enter the following details:
  - IPv6 address
  - Link-layer addr
  - VLAN nterface
3. Click **Submit**.
4. Click **Pending Changes**.
5. In the **Pending Changes** window, select the check box and click **Deploy changes**.

### In the CLI

To configure a static neighbor on a VLAN interface:

```
(host) [md] (config)#ipv6 neighbor <ipv6addr> vlan <vlan#> <mac>
```

## Configuring IPv6 Default Gateway and Static IPv6 Routes

You can configure IPv6 default gateway and static IPv6 routes using the WebUI or CLI.

### In the WebUI

#### To configure IPv6 Default Gateway

1. In the **Managed Device** node hierarchy, navigate to the **Configuration > Interfaces** and select the **IP Routes** tab.
2. Click **+** under the **Static Default Gateway** accordion.
3. Select IPv6 as **IP version**, and enter the IPv6 address in the **IP address** field.
4. Click **Submit** to add the address to the IPv6 default gateway table.
5. Click **Pending Changes**.
6. In the **Pending Changes** window, select the check box and click **Deploy changes**.

## To Configure Static IPv6 Routes

1. Click + under the **IP Routes** accordion.
2. Select IPv6 as **IP version**.
3. Enter the **Destination IP address** and the **Forwarding settings**.
4. Click **Submit** to add the static route to the IPv6 routes table.
5. Click **Pending Changes**.
6. In the **Pending Changes** window, select the check box and click **Deploy changes**.

## In the CLI

To configure the IPv6 default gateway:

```
(host) [md] (config)#ipv6 default-gateway <ipv6-address> <cost>
```

To configure static IPv6 routes:

```
(host) [md] (config)#ipv6 route <ipv6-prefix/prefix-length> <ipv6-next-hop> <cost>  
<ipv6-next-hop> = X:X:X:X::X
```

## Configuring Prefix Delegation

Prefix delegation can be used to assign a network address prefix to a customer site, as defined in IPv6 prefix delegation protocol (RFC 3769). The hosts at the customer site use this prefix to derive a unique IPv6 address using RA and SLAAC. Prefix delegation client uses DHCPv6 IA\_PD to request and assign prefixes.

As part of addition of prefix delegation, the following features are supported on the managed device:

- IPv6 address can be assigned using DHCPv6 IA\_NA. For DHCPv6 stateful address assignment, DHCP client process is started for the interface VLAN to retrieve and manage the address.
- PD client is supported to retrieve the prefix from ISP using DHCPv6 IA\_PD, PD client process is started for interface VLAN to retrieve and manage the IA\_PD lease.
- A PD-based address, based on the prefix obtained on uplink VLAN using PD client can be configured on other interface VLANs. When a PD-based address is configured, that prefix is advertised using RA on that VLAN. This RA helps the host to derive a unique SLAAC address from the prefix advertised.



---

PD client and DHCPv6 client are not allowed to be configured in different VLANs. PD-based address cannot be configured on an interface that is configured to run PD/DHCPv6 clients.

---

## In the CLI

Execute the following command in the CLI to automate prefix delegation, and stateful IPv6 address configuration:

### IPv6 address configuration under interface vlan

```
(host) [md] (config)#interface vlan 101  
(host) [md] (config-submode)#ipv6 address  
    dhcp6-client  
    link-local  
    pd  
    X:X:X:X::X/<0-128>  
(host) [md] (config-submode)#ipv6 address dhcp6-client
```

### Prefix delegation configuration under interface vlan

```
(host) [md] (config-submode)#ipv6 dhcp  
    pdclient  
    server  
(host) [md] (config-submode)#ipv6 dhcp pdclient  
    <pd_name>
```

## IPv6 PD-based address configuration under interface vlan

```
(host) [md] (config)#interface vlan 101
(host) [md] (config-submode)#ipv6 address
                dhcp6-client
                link-local
                pd
                X:X:X:X::X/<0-128>
(host) [md] (config-submode)#ipv6 address pd <pd_name> ::X:X:X:X:X
```

## IPv6 PD status

```
(host) [md] #show ipv6 pd status
DHCPv6 PD Client is enabled
Uplink VLAN      : 100
Label           : sitel
Prefix          : 2001:0:3::/48
65536 unique /64 prefixes are derivable from the acquired IA PD lease
Preferred lifetime 604800s, Valid lifetime 2592000s
Last request/renewal for the lease done at Thu Apr 14 04:46:15 2016
Lease expires at Sat May 14 04:46:15 2016
Downlink VLANs
-----
VlanId  Prefix
-----  -----
101     2001:0:3:12:1:2:3:4/64
```

## Managing IP Addresses

You can change the default managed device IP address by assigning a different VLAN interface address or the loop back interface address. You can also turn on Syslog messaging for IPv6 (similar to IPv4 logging) using the `logging <ipv6 address>` command. For more information on logging, see [Configuring Logging on page 786](#). You can use the WebUI or CLI to change the default managed device IP address.

### In the WebUI

1. In the **Managed Device** node hierarchy, navigate to the **Configuration > System > General** tab.
2. Select the **Controller IP address** accordion, select the VLAN Id or the loopback interface Id from the **IPv6 address** drop-down.
3. Click **Submit**.
4. Click **Pending Changes**.
5. In the **Pending Changes** window, select the check box and click **Deploy changes**.

### In the CLI

To configure an IPv6 address to the managed device:

```
(host) [md] (config)#controller-ipv6 loopback
(host) [md] (config)#controller-ipv6 vlan <id> address <ipv6 address>
```

To enable logging over IPv6:

```
(host) [md] (config)#logging <ipv6 address>
```

## Configuring Multicast Listener Discovery

You can enable the IPv6 multicast snooping on the managed device by using the WebUI or CLI and configure Multicast Listener Discovery (MLD) parameters such as query interval, query response interval, robustness variable, and ssm-range.



The Source Specific Multicast (SSM) supports delivery of multicast packets that originate only from a specific source address requested by the receiver. You can forward multicast streams to the clients if the source and group match the client subscribed source group pairs (S,G).

The managed device supports the following IPv6 multicast source filtering modes:

- **Include** - In Include mode, the reception of packets sent to a specified multicast address is enabled only from the source addresses listed in the source list. The default IPv6 SSM address range is FF3X::4000:1 – FF3X::FFFF:FFFF, and the hosts subscribing to SSM groups can only be in the Include mode.
- **Exclude** - In Exclude mode, the reception of packets sent to a specific multicast address is enabled from all source addresses. If there is a client in the Exclude mode, the subscription is treated as an MLDv1 join.

For more information on MLD feature, see **RFC 3810** and **RFC 4604**,

MLD snooping does not add IPv6 Solicited-Node multicast address or groups to the multicast table. A Solicited-Node multicast address is an IPv6 multicast address valid within the local-link (example, an Ethernet segment or a Frame Relay cloud). Every IPv6 host has at least one such address per interface. Solicited-Node multicast addresses are used in Neighbor Discovery Protocol for obtaining the layer 2 link-layer addresses of other nodes.

## In the WebUI

To modify IPv6 MLD Snooping:

1. In the **Managed Device** node hierarchy, navigate to the **Configuration > Interfaces > VLANs** tab.
2. Click a VLAN name under **VLANs** and click the corresponding VLAN id under **Vlan Ids**.
3. Select **IPv6** tab and **Multicast Listener Discovery (MLD)** accordion.
4. Select **Enabled** from the **MLD snooping** drop-down list to enable IPv6 MLD snooping.
5. Click **Submit**.
6. Click **Pending Changes**.
7. In the **Pending Changes** window, select the check box and click **Deploy changes**.

To modify IPv6 MLD parameters execute the following in a managed device:

1. In the **Managed Device** node hierarchy, navigate to the **Configuration > Interfaces > Multicast** tab.
2. Under the **MLD** accordion, enter the required values in the following fields:
  - **Robustness variable**: default value is 2
  - **Query interval**: default value is 125 seconds
  - **Query response interval**: default value is 100 (1/10 seconds).
3. Click **Submit**.
4. Click **Pending Changes**.
5. In the **Pending Changes** window, select the check box and click **Deploy changes**.

To configure the SSM Range execute the following in a managed device:

1. In the **Managed Device** node hierarchy, navigate to **Configuration > Interfaces** page and select the **Multicast** tab.
2. In the **MLD** accordion, use the **SSM range start-ip** and **SM range mask-ip** fields to configure the SSM Range.
3. Click **Submit** to save your changes.
4. Click **Pending Changes**.
5. In the **Pending Changes** window, select the check box and click **Deploy changes**.

## In the CLI

To enable IPv6 MLD snooping:

```
(host) [md] (config) #interface vlan 1  
  
(host) [md] (config-submode)#ipv6 mld snooping
```

To view if IPv6 MLD snooping is enabled:

```
(host) [md] (config-submode)#show ipv6 mld interface
```

To view the MLD Group information:

```
(host) [md] (config)#show ipv6 mld group
```

To modify IPv6 MLD parameters:

```
(host) [md] (config)#ipv6 mld  
(host) [md] (config-mld) # query-interval <time in seconds (1-65535)>|query-response-interval  
<time in 1/10th of seconds (1-65535)|robustness-variable <value (2-10)>
```

To view MLD configuration:

```
(host) [md] (config-submode)#show ipv6 mld config
```



---

When you enter the SSM range ensure that the upstream router has the same range, else the multicast stream would be dropped.

---

## Dynamic Multicast Optimization

When multiple clients are associated to an AP and when one client is subscribed for a multicast stream, all the clients associated to the AP receive the stream, as the packets are directed to the multicast MAC address. To restrict the multicast stream to only the subscribed clients, Dynamic Multicast Optimization (DMO) sends the stream to the unicast MAC address of the subscribed clients. DMO is currently supported for both IPv4 and IPv6.

To configure DMO, execute the following command:

```
(host) [md] (config) #wlan virtual-ap default  
(host) [md] (Virtual AP profile "default") #dynamic-mcast-optimization
```

To verify the DMO configuration, execute the following command:

```
(host) #show wlan virtual-ap
```

## Limitations

The following are the MLDv2 limitations:

- Managed Device cannot route multicast packets.
- For mobility clients mld proxy should be used.
- VLAN pool scenario stream is forwarded to clients in both the VLANs even if the client from one of the VLANs is subscribed.
- DMO is applicable for wired clients in managed device.

## Debugging IPv6

ArubaOS provides the following debug commands for IPv6:

- `show ipv6 global` — displays if IPv6 is enabled globally or not
- `show ipv6 interface` — displays the configured IPv6 address, and any duplicate addresses
- `show ipv6 route/show datapath route ipv6` — displays the IPv6 routing information
- `show ipv6 ra status` — displays the Router Advertisement status

- `show Datapath session ipv6` — displays the IPv6 sessions created, and the sessions that are allowed
- `show datapath frame` — displays the IPv6 specific counters

You can also use the debug options such as ping and tracepath for IPv6 hosts. You can either use the WebUI or the CLI to use the ping and tracepath options.

### In the WebUI

1. To ping an IPv6 host, in the **Mobility Master** node hierarchy, navigate to **Diagnostics > Tools > Ping** tab, enter an IPv6 address, and click **Ping**.
2. To trace the path of an IPv6 host, in the **Mobility Master** node hierarchy, navigate to **Diagnostics > Tools > Tracepath** tab, enter an IPv6 address, and click **Trace**.

### In the CLI

To ping an IPv6 host:

```
(host)#ping ipv6 <global-ipv6-address>
(host)#ping ipv6 interface vlan <vlan-id> <linklocal-address>
```

To trace the path of an IPv6 host:

```
(host)#tracepath <global-ipv6-address>
```

## Provisioning an IPv6 AP

You can provision an IPv6 AP on an IPv6 Mobility Master. You can either configure a static IP address or obtain a dynamic IPv6 address via stateless-autoconfig. The managed device can act as the default gateway for the IPv6 clients, if static IPv6 routes are set on the managed device.




---

A wired client can now connect to the Ethernet interface of an IPv6 enabled AP.

---

To provision a static IPv6 address using the CLI:

```
(host) [mynode](config)# provision-ap
```

### Enhancements to IPv6 Support on AP

ArubaOS provides the following IPv6 enhancements on the AP:

- DNS based IPv6 master discovery
- FTP support for image upgrade in an IPv6 network
- DHCPv6 client support

## Filtering an IPv6 Extension Header

ArubaOS firewall is enhanced to process the IPv6 Extension Header (EH) to enable IPv6 packet filtering. You can now filter the incoming IPv6 packets based on the EH type. You can edit the packet filter options in the default EH, using the CLI. The default EH alias permits all EH types.

Execute the following commands to permit or deny IPv6 packets matching an EH type:

```
(host) [md](config) #netexthdr default
(host) [md](config-exthdr) #eh <eh-type> permit | deny
```

To view the EH types denied:

```
(host) [md](config-exthdr) #show netexthdr default
```

## Configuring a Captive Portal over IPv6

IPv6 is now enabled on the captive portal for user authentication on the Aruba managed device. For user authentication, use the internal captive portal that is initiated from the managed device. A new parameter `captive` has been added to the IPv6 captive portal session ACL:

```
(host) [md] (config)#ipv6 user alias controller 6 svc-https captive
```



---

This release does not support external captive portal for IPv6. The captive portal authentication, customization of pages, and other attributes are same as IPv4.

---

You can configure captive portal over IPv6 (similar to IPv4) using the WebUI or CLI. For more information on configuration, see [Configuring Captive Portal in the Base Operating System on page 288](#).

## Working with IPv6 Router Advertisements

ArubaOS enables the managed device to send router advertisements (RA) in an IPv6 network. Each host auto generates a link local address when you enable `ipv6` on the host. The link local address allows the host to communicate between the nodes attached to the same link.

The IPv6 stateless autoconfiguration mechanism allows the host to generate its own addresses using a combination of locally available information and information advertised by the routers. The host sends a router solicitation multicast request for its configuration parameters in the IPv6 network. The source address of the router solicitation request can be an IP address assigned to the sending interface, or an unspecified address if no address is assigned to the sending interface.

The routers in the network respond with an RA. The RAs can also be sent at periodic intervals. The RA contains the network part of the Layer 3 IPv6 address (IPv6 Prefix). The host uses the IPv6 prefix provided by the RA; it generates the universally unique host part of the address (interface identifier), and combines the two to derive the complete address. To establish continuous connectivity to the default router, the host starts the neighbor reachability state machine for the router.



---

ArubaOS uses `Radvd`, an open source Linux IPv6 RA daemon maintained by Litech Systems Design.

---

You can perform the following tasks on the managed device to enable, configure, and view the IPv6 RA status on a VLAN interface:

- Configure IPv6 RA on a VLAN
- Configure Optional Parameters for RA
  - Configure neighbor discovery reachable time
  - Configure neighbor discovery retransmit time
  - Configure RA DNS
  - Configure RA hop-limit
  - Configure RA interval
  - Configure RA lifetime
  - Configure RA managed configuration flag
  - Configure RA MTU
  - Configure RA other configuration flag
  - Configure RA Preference
  - Configure RA prefix
- View IPv6 RA Status

## Configuring an IPv6 RA on a VLAN

You must configure the IPv6 RA functionality on a VLAN for it to send solicited/unsolicited RAs on the IPv6 network. You must configure the following for the IPv6 RA to be operational on a VLAN:

- IPv6 global unicast address
  - enable IPv6 RA
  - IPv6 RA prefix
- 
- The advertised IPv6 prefix length must be 64 bits for the stateless address autoconfiguration to be operational.
  - You can configure up to three IPv6 prefixes per VLAN interface.
  - Each IPv6 prefix must have an on-link interface address configured on the VLAN.
  - Ensure you configure the upstream routers to route the packets back to Aruba managed device.
- 



You can use the WebUI or CLI to configure the IPv6 RA on a VLAN.

### In the WebUI

1. In the **Managed Device** node hierarchy, navigate to the **Configuration > Interfaces > VLANs** tab.
2. Select a VLAN name under the **VLANs** tab.
3. Select the corresponding VLAN ID from the **VLANs <name>** table and click **IPv6** tab.
4. To configure an IPv6 global unicast address, follow the steps below:
  - a. Enter IPv6 address and prefix-length in the **Global unicast address1** field. (Optional) Select the **EUI64 Format** check box, if applicable.
  - b. Click **Submit** to add the address to the global address list.
5. To enable an IPv6 RA on a VLAN, select **Enabled** from the **Router advertisements (ra)** drop-down under **Neighbor Discovery** accordion.
6. To configure an IPv6 RA prefix for a VLAN, follow the steps below:
  - a. Click **+** in the **RA prefixes** table in the **Neighbor Discovery** accordion.
  - b. Enter a value in the **IPv6 RA** field.
  - c. Click **OK**.You can add up to three IPv6 prefixes per VLAN interface.
7. Click **Submit**.
8. Click **Pending Changes**.
9. In the **Pending Changes** window, select the check box and click **Deploy changes**.

### In the CLI

Execute the following commands to configure router advertisements on a VLAN:

```
(host) [md] (config) #interface vlan <vlanid>
(host) [md] (config-subif) #ipv6 address <prefix>/<prefix-length>
(host) [md] (config-subif) #ipv6 nd ra enable
(host) [md] (config-subif) #ipv6 nd ra prefix X:X:X:X::X/64
```

## Configuring Optional Parameters for RAs

In addition to enabling the RA functionality, you can configure the following IPv6 neighbor discovery and RA options on a VLAN:

- Neighbor discovery reachable time – the time, in milliseconds, that a node assumes a neighbor is reachable after receiving a reachability confirmation.

- Neighbor discovery retransmit time – the time, in milliseconds, between retransmitted Neighbor Solicitation messages.
- RA DNS – the IPv6 recursive DNS Server for the VLAN.



- 
- On Linux systems, clients must run the open `rndssd` daemon to support the DNS server option.
  - Windows 7 does not support the DNS server option.
- 

- RA hop-limit – the IPv6 RA hop-limit value. It is the default value to be placed in the Hop Count field of the IP header for outgoing (unicast) IP packets.
- RA interval – the maximum and minimum time interval between sending unsolicited multicast router advertisements from the interface, in seconds.
- RA lifetime – the lifetime associated with the default router in seconds. A value of zero indicates that the router is not a default router and will not appear on the default router list. The router lifetime applies only to the router's usefulness as a default router; it does not apply to information contained in other message fields or options.
- RA managed configuration flag (Enable DHCP for address) – a flag that indicates that the hosts can use the DHCP server for address autoconfiguration besides using RAs.
- RA maximum transmission unit (MTU) – the maximum transmission unit that all the nodes on a link use.
- RA other configuration flag (Enable DHCP for other information – a flag that indicates that the hosts can use the administered (stateful) protocol for autoconfiguration of other (non-address) information.
- RA preference – the preference associated with the default router.

You can use the WebUI or CLI to configure these options.




---

It is recommended that you retain the default value of the RA interval to achieve better performance.

---




---

If you enable RAs on more than 100 VLAN interfaces, some of the interfaces may not send out the RAs at regular intervals.

---

## In the WebUI

1. In the **Managed Device** node hierarchy, navigate to the **Configuration > Interfaces** page and select the **VLANs** tab.
2. Select a VLAN name under the **VLANs** tab.
3. Select the corresponding VLAN ID from the **VLANs <name>** table and click **IPv6** tab.
4. Under **Neighbor Discovery** accordion, configure the following neighbor discovery and RA options for the VLAN based on your requirements:
  - a. Enter a value in the **Reachable time (ms)** field. The allowed range is 0-3,600,000 msec. The default value is zero.
  - b. Enter a value in the **Retransmit time (ms)** field. The allowed range is 0-3,600,000 msec. The default value is zero.
  - c. Enter a DNS server name in the **Recursive DNS servers** field.
  - d. Enter a hop-limit value in the **RA hop limit** field. The allowed range is 1-255. The default value is 64.
  - e. Enter a value in the **RA interval minimum (sec)** field. Allowed range is 3-0.75 times the maximum RA interval value in seconds. The default minimum value is 0.33 times the maximum RA interval value
  - f. Enter a value in the **RA lifetime (sec)** field. A value of zero indicates that the router is not a default router. Apart from a zero value, the allowed range for the lifetime value is the RA interval time to 9,000 seconds. The default and minimum value is three times the RA interval time.

- g. Select **Enabled** from the **DHCP for address** drop-down list to enable the hosts to use the DHCP server for address autoconfiguration apart from any addresses auto configured using the RA.
  - h. Enter a value in the **RA MTU option** field. The allowed range is 1,280-maximum MTU allowed for the link.
  - i. Select Enabled from the **DHCP for other info** drop-down list to enable the hosts to use the DHCP server for autoconfiguration of other (non-address) information.
  - j. Select the **Router preference** as **High, Medium, or Low**.
5. Click **Submit**.
  6. Click **Pending Changes**.
  7. In the **Pending Changes** window, select the check box and click **Deploy changes**.

## In the CLI

Execute the following CLI commands to configure the neighbor discovery and RA options for a VLAN interface:

To configure neighbor discovery reachable time:

```
(host) [md] (config) #interface vlan <vlan-id>
(host) [md] (config-subif)#ipv6 nd reachable-time <value>
```

To configure neighbor discovery retransmit time:

```
(host) [md] (config-subif)#ipv6 nd retransmit-time <value>
```

To configure IPv6 recursive DNS server:

```
(host) [md] (config-subif)#ipv6 nd ra dns X:X:X:X::X
```

To configure RA hop-limit:

```
(host) [md] (config-subif)#ipv6 nd ra hop-limit <value>
```

To configure RA interval:

```
(host) [md] (config-subif)#ipv6 nd ra interval <value> <min-value>
```

To configure RA lifetime:

```
(host) [md] (config-subif)#ipv6 nd ra life-time <value>
```

To enable hosts to use DHCP server for stateful address autoconfiguration:

```
(host) [mynode] (config-subif)#ipv6 nd ra managed-config-flag
```

To configure maximum transmission unit for RA:

```
(host) [md] (config-subif)#ipv6 nd ra mtu <value>
```

To enable hosts to use DHCP server for other non-address stateful autoconfiguration:

```
(host) [md] (config-subif)#ipv6 nd ra other-config-flag
```

To specify a router preference:

```
(host) [md] (config-subif)#ipv6 nd ra preference [High | Low | Medium]
```

To view the IPv6 RA status on the VLAN interfaces:

```
(host) [md]#show ipv6 ra status
```

## IPsec Support

IPsec support is enhanced to accommodate IPv6 which includes overlay networks across IPv4 and IPv6 IPsec Tunnels. IPsec is the base for security features like Site-to-Site VPNs, CPsec, RAP, and Master-Local deployments. The control plane handles the configuration of these features and translation to IPsec Security

Association. The data plane handles encryption / decryption, encapsulation / decapsulation, tunneling, session setup, management, and routing of IPsec data.

In this release, IKEv2/IPsec support is extended to IPv6 for the following topologies:

- [Mobility Master-Managed Devices](#)
- [Control Plane Security \(Tunnel Mode and D-Tunnel Mode\)](#)
- [RAP \(Tunnel Mode and D-Tunnel Mode\)](#)
- [Site-to-Site Crypto Map \(Tunnel Mode and Transport Mode\)](#)

## Mobility Master-Managed Devices

This topology is used to secure all control plane traffic exchanged between Mobility Master and a managed device. This is specifically used by **CFGM** process to push configuration from Mobility Master to the managed device.

While configuring IPv6 local and master addresses, assign and use an IPv4 address to accommodate all the other applications that are yet to be enhanced to support IPv6 addresses. For example, License Manager still listens on IPv4 address and this needs to be accommodated by Mobility Master- Managed Devices IPv6 deployment.

### Configuring the Mobility Master IPv6 Address

You can configure the master IPv6 address used for pre-shared key authentication on the managed device, using the WebUI and CLI.



---

The initial IPv6 masteripv6 configuration on local needs to be done using the CLI. Once configured, any change in masteripv6 can be done through WebUI/CLI. This change in masteripv6 should remain in the same IP address family. Change from masteripv6 to masterip (vice-versa) requires a write erase on the managed device.

---

#### In the WebUI

Execute the following steps in the WebUI to configure the master IPv6 address for pre-shared key authentication:

1. In the **Managed Device** node hierarchy, navigate to the **Configuration > Controllers** menu.
2. Select a controller from the **Controllers** table.
3. Select **PSK** from the **Authentication** drop-down list.
4. Enter the **Mobility master IPV4 address**, **Mobility master IPV6 address**, and **Passphrase**.
5. Click **Submit**.
6. Click **Pending Changes**.
7. In the **Pending Changes** window, select the check box and click **Deploy changes**.

#### In the CLI

Execute the following command in the CLI to configure the master IPv6 address for pre-shared key authentication:

```
(host) [md] (config) #masteripv6 <masteripv6>
    ipsec <key> [fqdn <local-fqdn>] [interface|{vlan <id>}] [masteripv4 <masteripv4>]
```

You can configure the master IPv6 address used for certificate-based authentication on the managed device.

#### In the WebUI

Execute the following steps in the WebUI to configure the master IPv6 address for certificate-based authentication:

1. In the **Managed Device** node hierarchy, navigate to the **Configuration > Controllers** menu.



2. Select a controller from the **Controllers** table.
3. Select **Certificate** from the **Authentication** drop-down list.
4. Select **Custom/Factory** from the **Certificate type** drop-down list.
5. Enter the **Mobility master IPV4 address** and **Mobility master IPV6 address**.
6. Click **Submit**.
7. Click **Pending Changes**.
8. In the **Pending Changes** window, select the check box and click **Deploy changes**.

### In the CLI

Execute the following command in the CLI to configure the master IPv6 address for certificate-based authentication:

```
(host) [myd] (config) #masteripv6 <masteripv6>
ipsec-custom-cert master-mac-1-c <mac-1-c> ca-cert <ca> server-cert [fqdn-v <local-fqdn-v>]
[interface-c {uplink-v <uplink-v> | vlan-c <id-c>} masteripv4 {fqdn-v|interface-
c|masteripv4|suite-b} suite-b {fqdn-v|interface-c|masteripv4|suite-b}
ipsec-factory-cert master-mac-1 <MAC> [fqdn-c <local-fqdn-c>][interface-v {uplink-v
<uplink-v> | vlan-c <id-c>} [master-mac-2 <MAC>] [masteripv4 <masteripv4>]
```

### Configuring IPv4/IPv6 Address for PSK Authentication

On Mobility Master, you can configure the IPv4/IPv6 address of the managed device, to be used for pre-shared key authentication:

#### In the WebUI

Execute the following steps in the WebUI to configure the IPv6 address of the managed device for pre-shared key authentication:

1. In the **Mobility Master** node hierarchy, navigate to the **Configuration > Controllers** menu.
2. Click + under **Local Controllers IPsec Keys** table.
3. Select **IPsec Key** from the **Authentication** drop-down list.
4. Enter the **Local controller IPv4 address**, **Local controller IPv6 address**, and the **IPsec key** in the **Add New IPsec Controller** table.
5. Retype the IPsec key.
6. Click **Submit**.
7. Click **Pending Changes**.
8. In the **Pending Changes** window, select the check box and click **Deploy changes**.

#### In the CLI

Execute the following command in the CLI to configure the IPv6 address of the managed device for pre-shared key authentication:

```
(host) [mynode] (config) #localipv6 <local-switch-ipv6> ipsec <pre-shared-key> localipv4 <local-
switch-ipv4>
```

You can configure the certificate-based authentication on the managed device.

### Configuring IPv4/IPv6 Address for Certificate-Based Authentication

On Mobility Master, you can configure the IPv4/IPv6 address of the managed device, to be used for certificate-based authentication:

## In the WebUI

Execute the following steps in the WebUI to configure the IPv6 address of the managed devices for certificate-based authentication:

1. In the **Mobility Master** node hierarchy, navigate to the **Configuration > Controllers** menu.
2. Click + under **Local Controllers IPsec Keys** table.
3. Select **Certificate** from the **Authentication** drop-down list.
4. Enter the **Mac address** of the managed device.
5. Select **Factory** from the **Certificate type** drop-down list.
6. Click **Submit**.
7. Click **Pending Changes**.
8. In the **Pending Changes** window, select the check box and click **Deploy changes**.

## In the CLI

Execute the following steps in the CLI to configure certificate-based authentication on the managed device:

```
(host) [mynode] (config) #local-custom-cert local-mac <MAC> ca-cert <ca-cert-name> server-cert <server-cert-name> suite-b <gcm128/gcm256> load-balance
```

## Monitoring and Managing Master Local IPv6 Settings

Execute the following command in the CLI, on Mobility Master to check the ipv6 address of the managed device:

```
(host) [mynode] (config) #show localipv6
Local Switches configured by Local Switch IPv6
-----
Switch IPv6 address of the Local  Corres IPv4 address of the Local  Key
-----
2002::1                          1.1.1.1                          *****
```

Execute the following command in the CLI to check the IKE security associations:

```
(host) [mynode] #show crypto isakmp sa
ISAKMP SA Active Session Information
-----
Initiator IP      Responder IP      Flags            Start Time        Private IP
-----
ISAKMP SA Active Session Information
-----
Initiator IP      Responder IP      Flags            Start Time        Private IP
-----
2002::1           2002::3           r-v2-p          Dec  4 15:15:31   -
Flags: i = Initiator; r = Responder
m = Main Mode; a = Agressive Mode; v2 = IKEv2
p = Pre-shared key; c = Certificate/RSA Signature; e = ECDSA Signature
x = XAuth Enabled; y = Mode-Config Enabled; E = EAP Enabled
3 = 3rd party AP; C = Campus AP; R = RAP; Ru = Custom Certificate RAP;

I = IAP
V = VIA; S = VIA over TCP
Total ISAKMP SAs: 1
```

Execute the following command in the CLI to check the IPsec security associations:

```
(host) [mynode] #show crypto ipsec sa
IPSEC SA (V2) Active Session Information
-----
Initiator IP      Responder IP      SPI(IN/OUT)      Flags Start Time        Inner IP
-----
2002::1           2002::3           cdb5f100/d533c500 T2    Dec  4 14:53:42    -
Flags: T = Tunnel Mode; E = Transport Mode; U = UDP Encap
```

L = L2TP Tunnel; N = Nortel Client; C = Client; 2 = IKEv2  
 Total IPSEC SAs: 1

Execute the following command in the CLI to retrieve the statistics of communication between Mobility Master and the managed device:

```
(host) [mynode] #show master-local stats 2002::1
Missed -> HB Req from Local(s)
-----
IP Address  HB Req      HB Resp      Cfg Terminate  Peer Reset  Total Missed
-----
32.2.0.0    35155       35155        0               0           0

Last Sent Missed  Last Synced/First Missed
-----
0                 Pending
```

Execute the following command in the CLI to check the progress of the configuration update:

```
(host) [mynode] #show switches state [complete|incomplete|inprogress|required]

(host) [mynode] (config) #show switches state complete
All Switches
-----
IP Address  IPv6 Address  Name          Location      Type  Model          Version
-----
1.1.1.1     2002::1       abhi_vmc_61.122  Building1.floor1  LC    VMC-TACTICAL  8.0.0.0-svcs-ctrl_0000

Status      Configuration State  Config Sync Time (sec)  Config ID
-----
up          UPDATE SUCCESSFUL    0                        22
Total Switches:1

(host) [mynode] (config) #show switches state incomplete
All Switches
-----
IP Address  IPv6 Address  Name  Location  Type  Model  Version  Status  Configuration State
-----

Config Sync Time (sec)  Config ID
-----
Total Switches:0

(host) [mynode] (config) #show switches state inprogress
All Switches
-----
IP Address  IPv6 Address  Name  Location  Type  Model  Version  Status  Configuration State
-----

Config Sync Time (sec)  Config ID
-----
Total Switches:0

(host) [mynode] (config) #show switches state required
All Switches
-----
IP Address  IPv6 Address  Name  Location  Type  Model  Version  Status  Configuration State
-----

Config Sync Time (sec)  Config ID
-----
Total Switches:0
```

## Control Plane Security (Tunnel Mode and D-Tunnel Mode)

Control Plane security (CPSec) feature enables communication between an IPsec enabled AP (in CPsec mode) and a Mobility Master. The configuration traffic between the Mobility Master and AP (in CPsec mode) is routed through an IPsec tunnel, whereas the client traffic served by the AP is communicated to the Mobility Master in clear. Heartbeats go in a GRE tunnel, even though they are locally generated.

### Enabling a Range of IPv6 Addresses

An AP can terminate on a Mobility Master, if Auto Cert Provisioning is enabled in the CPsec profile or if a range of IPv6 addresses are enabled under CPsec profile, and if Auto Cert Provisioning is disabled.

#### In the WebUI

Execute the following steps in the WebUI to enable a range of IPv6 addresses:

1. In the **Managed Device** node hierarchy, navigate to the **Configuration > System > CPSEC** tab.
2. Click **Control Plane Security** accordion.
3. Select the **Enable CPSEC** check box.
4. Select the **Enable Auto Cert Provisioning** check box.
5. Select the **Only accept APs from specified ranges** check box.
6. Click **+** in the **Address ranges for Auto Cert Provisioning** table.
7. Enter the **Start address (Ipv4/Ipv6)** and **End address (IPv4/IPv6)** in the **New Address Range** dialogue box.
8. Click **OK**.
9. Click **Submit**.
10. Click **Pending Changes**.
11. In the **Pending Changes** window, select the check box and click **Deploy changes**.

#### In the CLI

Execute the following command in the CLI to enable a range of IPv6 addresses:

```
(host) [md] (config) #control-plane-security
(host) [md] (Control Plane Security Profile) #auto-cert-allowed-addr <startv6> <endv6>
```

Execute the following command in the CLI to accept cert-provisioning for all the IPv6 addresses:

```
(host) [md] (config) #control-plane-security
(host) [md] (Control Plane Security Profile) #auto-cert-allow-all
```

You can check if the control plane security is enabled by executing the following command:

```
(host) [md] (Control Plane Security Profile) #show control-plane-security
```

## RAP (Tunnel Mode and D-Tunnel Mode)

An AP terminating with an IPv6 address can be provisioned as a RAP using certs only. IPv6 L2TP pool is provisioned to assign IPv6 inner-ip address to AP. When a configuration request is initiated, the AP requests for IPv6 inner IP as the peer switch-ip.



---

In this release, only certificate-based RAP in forward-mode and decrypt mode tunnel is supported.

---

## Provisioning an Inner IPv6 Address to a RAP

You can provision an inner IPv6 address to a RAP, by configuring L2TP IPv6 Pool address range.

### In the WebUI

Execute the following steps in the WebUI to provision an inner IPv6 address to a RAP, by configuring L2TP IPv6 Pool address range:

1. In the **Mobility Master** node hierarchy, navigate to the **Configuration > Services > VPN** tab.
2. Click **General Vpn**.
3. Click + in the **Address Pools** table.
4. Enter the **Pool Name**, **Start address**, and **End address** in the **Add New Address Pool** table.
5. Click **Submit**.
6. Click **Pending Changes**.
7. In the **Pending Changes** window, select the check box and click **Deploy changes**.

### In the CLI

Execute the following command in the CLI to provision an inner IPv6 address to a RAP, by configuring L2TP IPv6 Pool address range:

```
(host) [mynode] (config) #ipv6 local pool <pool_name_v6> <pool_start_addressv6> <pool_end_addressv6>
```

Execute the following command in the CLI to view the total number of IPs in each pool and the IPs assigned from each pool:

```
(host) [mynode] (config) #show vpdn l2tp local pool
```

Execute the following command in the CLI to view the pools configured:

```
(host) [mynode] (config) #show vpdn l2tp configuration
```

You can provision an inner IPv6 address to a RAP, by configuring remote IP to the whitelist-db entry.

### In the CLI

Execute the following command in the CLI to provision an inner IPv6 address to a RAP, by configuring remote-ipv6 address in the whitelist DB entry:

```
(host) [mynode] (config) #whitelist-db rap add mac-address <mac address> ap-group <ap_group> remote-ipv6 <remote_ipv6>
```

## Site-to-Site Crypto Map (Tunnel Mode and Transport Mode)

A Virtual Private Network (VPN) consists of multiple remote peers transmitting private data securely to one another over an unsecured network, such as the Internet. Site-to-site VPNs use tunnels to encapsulate data packets within normal IP packets for forwarding over IP-based networks; encryption ensures that privacy and authentication to ensure integrity of data. Listed below are the types of deployments supported in this release:

- IPv6 networks over IPv6 IPsec tunnel
- IPv6 networks over IPv4 IPsec tunnel
- IPv4 networks over IPv6 IPsec tunnel
- IPv4 and IPv6 networks over IPv4 IPsec tunnel
- IPv4 and IPv6 networks over IPv6 IPsec tunnel
- Static IPv6 Route to IPsec crypto-map
- IP compression support for IPv6 inner traffic



---

All IPv6 IPsec crypto maps are supported with IKE version v2 only.

---

## Configuring Site-to-Site VPN

You can configure a site-to-site VPN protecting IPv6 networks over an IPv6 IPsec tunnel.

### In the WebUI

Execute the following steps in the WebUI to configure a site-to-site VPN protecting IPv6 and IPv4 networks over an IPv6 IPsec tunnel:

1. In the **Mobility Master** node hierarchy, navigate to the **Configuration > Services > VPN** tab.
2. Click **Site to Site**.
3. Click + in the **IPSec Maps** table.
4. Enter the **IPv6 source network**, **IPv6 source prefix**, **Destination network**, **IPv6 destination prefix**, **Peer gateway v4/v6** details in the **Create New IPSec** table.
5. Click **Submit**.
6. Click **Pending Changes**.
7. In the **Pending Changes** window, select the check box and click **Deploy changes**.

### In the CLI

Execute the following command in the CLI to configure a site-to-site VPN protecting IPv6 networks over an IPv6 IPsec tunnel:

```
(host) [mynode] (config) #crypto-local ipsec-map <map name> <priority>
    version v2
    peer-ipv6 <IPv6 address>
    vlan 1
    src-net-ipv6 <IPv6 address> <Prefix length>
    dst-net-ipv6 <IPv6 address> <Prefix length>
    src-net <IPv4 address> <mask>
    dst-net <IPv4 address> < mask>
```

## Adding a New IPv6 Static Route

You can add a new IPv6 static route to an existing crypto-map.

### In the WebUI

Execute the following steps in the WebUI to add a new IPv6 static route to an existing crypto-map:

1. In the **Managed Device** node hierarchy, navigate to the **Configuration > Interfaces > IP Routes** tab.
2. Click **IP Routes**.
3. Click + symbol in the **IP Routes** table.
4. Select **Using IPsec Name Map** from the **Forwarding Settings** drop-down list.
5. Click **Submit**.
6. Click **Pending Changes**.
7. In the **Pending Changes** window, select the check box and click **Deploy changes**.

### In the CLI

Execute the following command in the CLI to add a new IPv6 static route to an existing crypto-map:

```
(host) [md] (config) #ipv6 route <ipv6-network/prefix> ipsec <name>
```

## Associating a Pre-shared Key

You can associate a pre-shared-key to the site-to-site crypto-map.



---

Hex based pre-shared key is supported.

---

### In the WebUI

Execute the following steps in the WebUI to associate a pre-shared-key to the site-to-site crypto-map:

1. In the **Managed Device** node hierarchy, navigate to the **Configuration > Services > VPN** tab.
2. Click **Site to Site** accordion.
3. Click + in the **IPSec Maps** table and enter the following details in the **Create New Isec** table.
  - a. Select **Text-Based** or **Hex-based** from the **Representation type** drop-down list.
  - b. Enter the **IKE shared secret** and **Retype shared secret**.
4. Click **Submit**.
5. Click **Pending Changes**.
6. In the **Pending Changes** window, select the check box and click **Deploy Changes**.

### In the CLI

Execute the following command in the CLI to associate a pre-shared-key to the site-to-site crypto-map:

```
(host) [md] (config) #crypto-local isakmp key <key> addressv6 <IPv6 address> <prefix length>
(host) [md] (config) #crypto-local isakmp key-hex <key> addressv6 <IPv6 address> <prefix length>
```



---

Hex based pre-shared key is supported.

---

## Associating a Certificate Based Authentication

You can configure certificate based authentication for the site-to-site crypto-map.

### In the WebUI

Execute the following steps in the WebUI to associate a pre-shared-key to the site-to-site crypto-map:

1. In the **Managed Device** node hierarchy, navigate to the **Configuration > Services > VPN** tab.
2. Click **Site to Site** accordion.
3. Click + symbol in the **IPSec Maps** table and enter the following details in the **Create New Isec** table.
  - a. Select **Certificate** from the **Authentication method** drop-down list.
  - b. Select values for **Server certificate** and **CA certificate** from the drop-down list.
  - c. Enter a value for the **Peer certificate subject name** field.
4. Click **Submit**.
5. Click **Pending Changes**.
6. In the **Pending Changes** window, select the check box and click **Deploy changes**.

### In the CLI

Execute the following command in the CLI to associate a pre-shared-key to the site-to-site crypto-map:

```
(host) [md] (config) #crypto-local ipsec-map <map name> <priority>
(host) [md] (config) #set ca-certificate <ca-certificate>
(host) [md] (config) #set server-certificate <server-certificate>
```



---

If you configure your Mobility Master to use IKEv2 and custom-installed certificates, you can optionally use Suite-B cryptographic algorithms for IPsec encryption. Select either **gcm-128 Use 128-bit AES-GCM Suite-B encryption** or **gcm-256 Use 256-bit AES-GCM Suite-B encryption**.

---

## Monitoring and Managing Site-to-Site Settings

Execute the following command in the CLI to view the crypto Internet Security Association and Key Management Protocol (ISAKMP) for an IPv6 peer:

```
(host) [md] #show crypto isakmp sa peer v6 2002::1
Initiator IP: 2002::1
Responder IP: 2002::3
Initiator: No
Initiator cookie:4ab9d9805eb16f73 Responder cookie:93f1c4dbec0ee92b
SA Creation Date: Fri Dec 4 23:14:33 2015
Life secs: 28800
Initiator Phase1 ID: 2002::1
Responder Phase1 ID: 2002::3
Exchange Type: IKE_SA (IKEV2)
Phase1 Transform:EncrAlg:AES128 HashAlg:HMAC_SHA1_96 DHGroup:2
Authentication Method: Pre Shared Key
IPSEC SA Rekey Number: 1
Ipssec-map name: default-local-master-ipsecmap2002::1
```

Execute the following command in the CLI to view the IPsec security association for an IPv6 peer:

```
(host) [md] #show crypto ipsec sa peer v6 2002::1
Initiator IP: 2002::1
Responder IP: 2002::3
Initiator: No
SA Creation Date: Sat Dec 5 00:50:01 2015
Life secs: 7200
Exchange Type: IKE_SA (IKEV2)
Phase2 Transform:Encryption Alg: 3DES Authentication Alg: SHA1
Encapsulation Mode Tunnel
IP Compression Disabled
PFS: no
IN SPI: 1C514500, OUT SPI: 14F61800
Ipssec-map name: default-local-master-ipsecmap2002::1
Responder IP: 2002::3
```

Execute the following command in the CLI to view IKE transports:

```
(host) [md] #show crypto isakmp transports
transport 0x33cfb40 flags 0 refcnt 1
UDP-NATT Transport: fd 11 ikev2-id:0 src 1.1.1.10:4500 dst 1.1.1.4:4500
transport 0x2b3d660 flags 0 refcnt 1
UDP-500 Transport: fd 10 ikev2-id:0 src 1.1.1.10:500 dst 1.1.1.4:4500
transport 0x3292bb0 flags 0 refcnt 1
transport 0x298ea20 flags 1 refcnt 1
UDP-NATT Transport: fd 11 ikev2-id:0 src 0.0.0.0:4500 dst *:0
transport 0x298e940 flags 1 refcnt 1
UDP-500 Transport: fd 10 ikev2-id:0 src 0.0.0.0:500 dst
```

Execute the following command in the CLI to view IPv6 Switch address:

```
(host) [md] #show crypto isakmp stats
Switch IP = 1.1.1.10
Main Mode Initiator exchanges started/completed = 0/0
Main Mode Responder exchanges started/completed = 0/0
Aggr Mode Initiator exchanges started/completed = 0/0
Aggr Mode Responder exchanges started/completed = 104034/0
Quick Mode Initiator exchanges started/completed = 0/0
Quick Mode Responder exchanges started/completed = 0/0
XAuth Typel Responder exchanges started/completed = 0/0
```



```

XAuth Type2 Responder exchanges started/completed = 0/0
XAuth Authentication Pass/Fail = 0/0
Mode-Config Responder exchanges started/completed = 0/0
Mode-Config Authentication Pass/Fail = 0/0
XAuth Protocol Errors Bad-Packets/Quick-mode-fail = 0/0
IP Pool Alloc/Free/Free-NoSa Alloc-Error/Free-Error = 0/0/0/0/0
IP External Pool Alloc/Alloc-Error = 0/0
Authentication State Errors No-SA/No-Msg/No-Exch = 0/0/0
Auth Msgs Reqs/Rcvd/AP-Down/Idle-timeout/IP-down = 0/0/0/0/0
Auth Msg Errors Not-Ready/Reqs-Throttled/IP-UP-err/Recv-err/Rcv-NoState = 0/0/0/0/0
IKE->Auth Msgs IP-up/IP-down = 0/0
Cert-Revocation Msgs Reqs/Rcvd/Pass/Revoked = 0/0/0/0
Cert-Revocation Msg Errors Reqs-Throttled/Send-err/Recv-err/Rcv-NoState = 0/0/0/0
UDB Msgs Reqs-Throttled/Req-sent/Req-send-errors/Resp-rcvd/Rcv-NoState = 0/0/0/0/0
ACR License Msgs Request/Delete/Req-errors/Resp-rcvd/Resp-error = 0/0/0/0/0 Allow/Fail 0/0
Limit:1000
...

```

Execute the following commands in the CLI to clear IPsec and ISAKMP state security associations:

```

(host) [md] (config) #clear crypto isakmp sa peer v6 <>
(host) [md] (config) #clear crypto ipsec sa peer v6 <>

```

## IP Compression Support for IPv6 Traffic Inside an IPsec Tunnel

Support for IP Compression is extended to IPv6 traffic inside an IPsec tunnel to minimize the size of the packets crossing a public network where ISP charges are calculated based on the number of bytes transferred.

IP Compression is supported for IPv6 traffic in an IPv4 IPsec Tunnel as well as IPv6 IPsec Tunnel.

### In the CLI

Execute the following command in the CLI to enable/disable IP compression per crypto-map:

```

(host) [md] (config) #crypto-local ipsec-map test 9988
(host) [md] (config-submode) #ip-compression
(host) [md] (config-submode) #no ip-compression

```

Execute the following command in the CLI to verify if IP compression is enabled at the global level:

```

(host) [md] (config) #show crypto-local isakmp disable-ipcomp
IP Compression is Enabled

```

## RADIUS Over IPv6

ArubaOS provides support for RADIUS authentication server over IPv6. You can configure an IPv6 host or specify an FQDN that can resolve to an IPv6 address for RADIUS authentication. The RADIUS server is in IPv4 mode by default. You must enable the RADIUS server in IPv6 mode to resolve the specified FQDN to IPv6 address.




---

You can only configure the global IPv6 address as the host for the Radius server in IPv6 mode.

---

You can configure the IPv6 host for the RADIUS server using the WebUI or CLI.

### In the CLI

You must enable the `enable-ipv6` parameter to configure the RADIUS server in IPv6 mode.

```

(host) [mynode] (config) #aaa authentication-server radius IPv6
(host) [mynode] (RADIUS Server "IPv6") #enable-ipv6

```

Configure an IPv6 address as the host for RADIUS server using the following command:

```

(host) [mynode] (RADIUS Server "IPv6") #host <ipv6-address>

```

The <host> parameter can also be a fully qualified domain name that can resolve to an IPv6 address.



---

To resolve FQDN, you must configure the DNS server name using the `ip name-server <ip4addr>` command.

---

You can configure an IPv6 address for the NAS-IP parameter using the following CLI command:

```
(host) [mynode] (RADIUS Server "Ipv6") #nas-ip6 <IPv6 address>
```

You can configure an IPv6 address for the Source Interface parameter using the following CLI command:

```
(host) [mynode] (RADIUS Server "Ipv6") # source-interface vlan <vlan-id> ip6addr <ip6addr>
```

Use the following CLI command to configure an IPv6 address for the global NAS IP which the managed device uses to communicate with all the RADIUS servers:

```
(host) [mynode] (config) #ipv6 radius nas-ip6 <IPv6 address>
```

You can also configure an IPv6 global source-interface for all the RADIUS server requests using the following commands:

```
(host) [mynode] (config) #ipv6 radius source-interface loopback
```

```
(host) [mynode] (config) #ipv6 radius source-interface vlan <vlan-id> <ip6addr>
```

## In the WebUI

To configure an IPv6 host for a RADIUS server:

1. In the **Mobility Master** node hierarchy, navigate to the **Configuration > Authentication > Auth Servers** tab.
2. Select the RADIUS server to display the RADIUS server list.
3. Select the required RADIUS server from the list to go to the RADIUS server page.
4. To enable the RADIUS server in IPv6 mode select Enabled from the **Enable IPv6** drop-down list.
5. To configure an IPv6 host for the selected RADIUS server specify an IPv6 address or an FQDN in the **IP address** field.
6. Click **Submit**.
7. Click **Pending Changes**.
8. In the **Pending Changes** window, select the check box and click **Deploy changes**.

To configure an IPv6 address for the NAS-IP:

1. Specify an IPv6 address in the **NAS IPv6** field.
2. Click **Submit**.
3. Click **Pending Changes**.
4. In the **Pending Changes** window, select the check box and click **Deploy changes**.

## Radius Accounting for IPv6 Clients

Customers can now monitor bandwidth usage by clients/hosts with IPv6 addresses, over RADIUS protocol. The **Framed-IPv6-Address** attribute is used in accounting start, stop, and interim packets. A host can have multiple IPv6 addresses and all of them are tracked to check the usage, for billing purpose.

## TACACS Over IPv6

ArubaOS provides support for TACACS authentication server over IPv6. You can configure the global IPv6 address as the host for TACACS authentication using CLI or WebUI.

## In the CLI

```
(host) [mynode] (config) #aaa authentication-server tacacs IPv6
(host) [mynode] (TACACS Server "IPv6") #host <ipv6-address>
```

## In the WebUI

1. In the **Mobility Master** node hierarchy, navigate to the **Configuration > Authentication** page and select **Auth Servers** tab.
2. Select **TACACS Server** from **All Servers** table, to display the server list.
3. To configure an IPv6 host for the selected server, specify an IPv6 address in the **Host** field.
4. Click **Submit**.
5. Click **Pending Changes**.
6. In the **Pending Changes** window, select the check box and click **Deploy changes**.

## DHCPv6 Server

The DHCPv6 server enables network administrators to configure stateful/stateless options and manage dynamic IPv6 users connecting to a network. You can also configure domain name server using DHCPv6.

You can configure IPv6 pools with various configurations such as lease duration, DNS server, vendor specific options, and user defined options using DHCPv6. You can also exclude IPv6 addresses from subnets. Managed Device IPv6 addresses, VLAN interface IPv6 addresses, and DNS server addresses are excluded from use by default.

Similar to DHCPv4, a DHCPv6 server pool is associated with a VLAN only through the IPv6 address configured in that VLAN interface. A VLAN interface can have a maximum of three global unicast addresses, but only one DHCPv6 pool.

DHCPv6 server supports stateless configuration of clients with options apart from the network addresses described in RFC 3736.

### Points to Remember

- Similar to IPv4, the default router configuration is not required for IPv6 pools as IPv6 compliant routers will send RAs. The RA source address will be the default-gateway for the clients.
- ArubaOS does not support DHCPv6 relay and Hospitality feature on DHCPv6.

### DHCP Lease Limit

The following table provides the maximum number of DHCP leases (both v4 and v6) supported per platform:



---

There is a new enforcement to the existing DHCP limit during configuration.

---

**Table 25: DHCP Lease Limits**

Platform	DHCP Lease Limit
Virtual Mobility Master	512
Virtual Mobility Controller - 32	512
Virtual Mobility Controller - 50	1024
Virtual Mobility Controller - 250	2048
Virtual Mobility Controller - 1K	4096
7005	512
7008	512
7010	1024
7024	1024
7030	2048
7205	4096
7210	5120
7220	10240
7240	15360
7240XM	15360

## Configuring DHCPv6 Server

You must enable the global DHCPv6 knob for the DHCPv6 functionality to be operational. You can enable and configure DHCPv6 server using the WebUI or CLI.

### In the WebUI

1. In the **Managed Device** node hierarchy, navigate to **Configuration > Services > DHCP Server** tab.
2. Select **Enable** from the **IPv6 DHCP Server** drop-down list to enable DHCPv6 globally.
3. If there are addresses that should not be assigned in the subnetwork:
  - a. Under **IPv6 Excluded Address Range** table, click **+** to create a list of IPv6 excluded address.
  - b. Enter the excluded IPv6 address range in **IPv6 excluded range** and click **Apply**. The specified address range gets added to the **IPv6 Excluded Address** list box. The starting IP address in the **Exclude Address Range** should always contain a unique value, if the IP address is already present, then the existing IP address is replaced with a new one, and a warning is displayed.

4. Under **Pool Configuration**, click **+** to create a new DHCP server pool or click **Edit** to modify an existing DHCP server pool.



---

To enable the DHCPv6 Server functionality on an interface, select the **IP Interfaces** tab, edit the VLAN interface, and select a DHCP pool from the drop-down list under the **DHCP server** section. Ensure that the IP version of the VLAN interface is IPv6.

---

5. Select **IP version** as **IPv6** to create a DHCPv6 pool.
6. Enter a name in **Pool name** to configure an IPv6 pool name.
7. Enter an IPv6 address in **DNS servers** to configure an IPv6 DNS server.



---

To configure multiple DNS servers, enter the IPv6 addresses separated by space.

---

8. Enter a value in **Domain name** to configure the domain name.
9. Enter the number of days, hours, minutes, and seconds in **Lease days, Lease hours, Lease minutes, and Lease seconds** to configure the lease time. The default value is 12 hours.
10. Specify an IPv6 prefix in **Network IP Address** to configure an IPv6 network.
11. Enter the following details under **Option** to configure client specific DHCPv6 options.
  - a. Specify the option code in **Option**.
  - b. Select **IP** or **text** from the **IP/Text** drop-down list.
  - c. Enter a value in **Value**. If you selected *IP* in *step b*, then you must enter a valid IPv6 address in this field.
  - d. Click **OK**.
12. Click **Submit**.
13. Click **Pending Changes**.
14. In the **Pending Changes** window, select the check box and click **Deploy changes**.

## In the CLI

To enable the DHCPv6 service you can use the following command:

```
(host) [md] (config)#service dhcpv6
```

To configure a domain name server, execute the following commands:

```
(host) [md] (config)#ipv6 dhcp pool <pool-name>
(host) [md] (config-dhcpv6)#dns-server <ipv6-address>
```

To configure a domain name, use the following command:

```
(host) [md] (config-dhcpv6)#domain-name <domain>
```

To configure DHCPv6 lease time, use the following command:

```
(host) [md] (config-dhcpv6)#lease <days> <hours> <minutes> <seconds>
```

The default value is 12 hours.

To configure a DHCP network, use the following command:

```
(host) [md] (config-dhcpv6)#network <network-prefix>
```

To configure a client specific option, use the following command:

```
(host) [md] (config-dhcpv6)#option <code> [ip <ipv6-address> | text <string>]
```

To configure DHCP server preference, use the following command:

```
(host) [md] (config-dhcpv6)#preference <value>
```

To enable DHCPv6 Server functionality on an interface, use the following command:

```
(host) [md] (config) #interface vlan <vlan-id>
(host) [md] (config-subif) #ipv6 dhcp server <pool-name>
```



---

The configured DHCPv6 pool subnet must match the interface prefix for DHCPv6 Server to be active.

---

To configure the IPv6 excluded address range for the DHCPv6 server, use the following command:

```
(host) [md] (config)#ipv6 dhcp excluded-address <low-address> [<high-address>]
```

You can view the DHCPv6 server settings, statistics, and binding information using the CLI.

To view the DHCPv6 database, use the following command:

```
(host) [md] #show ipv6 dhcp database
```

You can also view the DHCPv6 database for a specific pool, use the following command:

```
(host) [md] #show ipv6 dhcp database [pool <pool-name>]
(host) [md] #show ipv6 dhcp database pool DHCPv6
```

To view the DHCPv6 binding information, use the following command:

```
(host) [md]# show ipv6 dhcp binding
```

To clear all the DHCPv6 bindings, use the following command:

```
(host) [md] # clear ipv6 dhcp binding
```

To view the DHCPv6 server statistics, use the following command:

```
(host) [md](config) #show ip dhcp statistics
```

To view the DHCPv6 active pools, use the following command:

```
(host) [md] #show ipv6 dhcp active-pools
```

## Understanding ArubaOS Supported Network Configuration for IPv6 Clients

ArubaOS provides wired or wireless clients using IPv6 addresses with services such as firewall functionality, layer-2 authentication, and, with the installation of the Policy Enforcement Firewall Next Generation (PEFNG), identity-based security. The Managed Device does not provide routing or Network Address Translation to IPv6 clients (see [Understanding IPv6 Exceptions and Best Practices on page 157](#)).

### Supported Network Configuration

Clients can be wired or wireless and use IPv4 and/or IPv6 addresses. An external IPv6 router is recommended for a complete routing experience (dynamic routing). You can use the WebUI or CLI to display IPv6 client information.

Managed Device can be configured with both IPv4 and IPv6 client addresses on the same VLAN.

### Understanding the Network Connection Sequence for Windows IPv6 Clients

This section describes the network connection sequence for Windows Vista/XP clients that use IPv6 addresses, and the actions performed by the AP and the Managed Device.

1. The IPv6 client sends a Router Solicit message through the AP. The AP passes the Router Solicit message from the IPv6 client through the GRE tunnel to the Managed Device.
2. The Managed Device removes the 802.11 frame and creates an 802.3 frame for the Router Solicit message.
  - a. The Managed Device authenticates the user, applies firewall policies, and bridges the 802.3 frame to the IPv6 router.
  - b. The Managed Device creates entries in the user and session tables.

3. The IPv6 router responds with a Router Advertisement message.
4. The Managed Device applies firewall policies, then creates an 802.11 frame for the Router Advertisement message. The Managed Device sends the Router Advertisement through the GRE tunnel to the AP.
5. The IPv6 client sends a Neighbor Solicitation message.
6. The IPv6 router responds with a Neighbor Advertisement message.
7. If the DHCP is required to provide IPv6 addresses, the DHCPv6 process is started.
8. The IPv6 client sends data.
9. The Managed Device removes the 802.11 frame and creates an 802.3 frame for the data.  
The Managed Device authenticates the user, applies firewall policies and bridges the 802.3 frame to the IPv6 router. The Managed Device creates entries in the user and session tables.




---

A client can have an IPv4 address and an IPv6 address, but the Managed Device does not relate the states of the IPv4 and the IPv6 addresses on the same client. For example, if an IPv6 user session is active on a client, the Managed Device will delete an IPv4 user session on the same client if the idle timeout for the IPv4 session is reached.

---

## Understanding ArubaOS Authentication and Firewall Features that Support IPv6

This section describes ArubaOS features that support IPv6 clients.

### Understanding Authentication

This release of ArubaOS only supports 802.1X authentication for IPv6 clients. You cannot configure layer-3 authentications to authenticate IPv6 clients.

**Table 26:** *IPv6 Client Authentication*

Authentication Method	Supported for IPv6 Clients
802.1X	Yes
Stateful 802.1X (with non-Aruba APs)	Yes
Local database	Yes
Captive Portal	Yes
VPN	Yes
xSec	No (not tested)
MAC-based	Yes

You configure 802.1X authentication for IPv6 clients in the same way as for IPv4 client configurations. For more information about configuring 802.1X authentication on the Mobility Master, see [802.1X Authentication on page 235](#).




---

This release does not support authentication of management users on IPv6 clients.

---

## Working with Firewall Features

If you installed a Policy Enforcement Firewall Next Generation (PEFNG) license in the Mobility Master, you can configure firewall functions for IPv6 client traffic. While these firewall functions are identical to firewall functions for IPv4 clients, you need to explicitly configure them for IPv6 traffic. For more information about firewall policies, see [Understanding Global Firewall Parameters on page 383](#).



---

Voice-related and NAT firewall functions are not supported for IPv6 traffic.

---

**Table 27:** IPv6 Firewall Parameters

Parameter	Description
Monitor Ping Attack (per 30 seconds)	Number of ICMP pings per 30 second, which if exceeded, can indicate a denial of service attack. Valid range is 1-16384 pings per 30 seconds.  Recommended value is 120.  Default: No default
Monitor TCP SYN Attack rate (per 30 seconds)	Number of TCP SYN messages per 30 second, which if exceeded, can indicate a denial of service attack. Valid range is 1-16384 pings per 30 seconds.  Recommended value is 960.  Default: No default
Monitor IP Session Attack (per 30 seconds)	Number of TCP or UDP connection requests per 30 second, which if exceeded, can indicate a denial of service attack. Valid range is 1-16384 requests per 30 seconds.  Recommended value is 960.  Default: No default
Deny Inter User Bridging	Prevents the forwarding of Layer-2 traffic between wired or wireless users. You can configure user role policies that prevent Layer-3 traffic between users or networks but this does not block Layer-2 traffic. This option can be used to prevent traffic, such as Appletalk or IPX, from being forwarded.  Default: Disabled
Deny All IP Fragments	Drops all IP fragments.  <b>NOTE:</b> Do not enable this option unless instructed to do so by an Aruba representative.  Default: Disabled
Enforce TCP Handshake Before Allowing Data	Prevents data from passing between two clients until the three-way TCP handshake has been performed. This option should be disabled when you have mobile clients on the network, as enabling this option will cause mobility to fail. You can enable this option if there are no mobile clients on the network.  Default: Disabled



**Table 27: IPv6 Firewall Parameters**

Parameter	Description
Prohibit IP Spoofing	Enables detection of IP spoofing (where an intruder sends messages using the IP address of a trusted client). When you enable this option, IP and MAC addresses are checked for each ARP request/response. Traffic from a second MAC address using a specific IP address is denied, and the entry is not added to the user table. Possible IP spoofing attacks are logged and an SNMP trap is sent.  Default: Disabled
Prohibit RST Replay Attack	When enabled, closes a TCP connection in both directions if a TCP RST is received from either direction. You should not enable this option unless instructed to do so by an Aruba representative.  Default: Disabled
Session Mirror Destination	Destination (IPv4 address or managed device port) to which mirrored session packets are sent. You can configure IPv6 flows to be mirrored with the session ACL "mirror" option. This option is used only for troubleshooting or debugging.  Default: N/A
Session Idle Timeout	Set the time, in seconds, that a non-TCP session can be idle before it is removed from the session table. Specify a value in the range 16–259 seconds. You should not set this option unless instructed to do so by an Aruba representative.  Default: 30 seconds
Per-packet Logging	Enables logging of every packet if logging is enabled for the corresponding session rule. Normally, one event is logged per session. If you enable this option, each packet in the session is logged. You should not enable this option unless instructed to do so by an Aruba representative, as doing so may create unnecessary overhead on the managed device.  Default: Disabled (per-session logging is performed)
IPv6 Enable	Enables IPv6 globally.

The following examples configure attack rates and the session timeout for IPv6 traffic.

To configure the firewall function via the WebUI:

1. In the **Mobility Master** node hierarchy, navigate to the **Configuration > Services > Firewall** tab.
2. Click **Global Setting** accordion.
3. Under the **IPv6** column, enter the following:
  - For **Monitor ping attack (per 30 sec)**, enter **15**
  - For **Monitor IP sessions attack (per 30 sec)**, enter **25**
  - For **Session idle timeout (sec)**, enter **60**
4. Click **Submit**.
5. Click **Pending Changes**.
6. In the **Pending Changes** window, select the check box and click **Deploy changes**.

To configure firewall functions using the command line interface, issue the following commands in config mode:

```
(host) [mynode] (config)#ipv6 firew all attack-rate ping 15
(host) [mynode] (config)#ipv6 firewall attack-rate session 25
```

```
(host) [mynode] (config)#ipv6 firewall session-idle-timeout 60
```

## Understanding Firewall Policies

A user role, which determines a client's network privileges, is defined by one or more firewall policies. A firewall policy consists of rules that define the source, destination, and service type for specific traffic, and whether you want the managed device to permit or deny traffic that matches the rule.

You can configure firewall policies for IPv4 traffic or IPv6 traffic, and apply IPv4 and IPv6 firewall policies to the same user role. For example, if you have employees that use both IPv4 and IPv6 clients, you can configure both IPv4 and IPv6 firewall policies and apply them both to the "employee" user role.

The procedure to configure an IPv6 firewall policy rule is similar to configuring a firewall policy rule for IPv4 traffic, but with some differences. [Table 18](#) describes the required and optional parameters for an IPv6 firewall policy rule.

**Table 28: IPv6 Firewall Policy Rule Parameters**

Field	Description
Source (required)	<p>Source of the traffic:</p> <ul style="list-style-type: none"><li>● <b>any</b>: Acts as a wildcard and applies to any source address.</li><li>● <b>user</b>: This refers to traffic from the wireless client.</li><li>● <b>host</b>: This refers to traffic from a specific host. When this option is chosen, you must configure the IPv6 address of the host. For example, 2002:d81f:f9f0:1000:c7e:5d61:585c:3ab.</li><li>● <b>network</b>: This refers to a traffic that has a source IP from a subnet of IP addresses. When you chose this option, you must configure the IPv6 address and network mask of the subnet. For example, 2002:ac10:fe::ffff:ffff:ffff::</li><li>● <b>alias</b>: This refers to using an alias for a host or network.</li></ul> <p><b>NOTE:</b> This release does not support IPv6 aliases. You cannot configure an alias for an IPv6 host or network.</p>
Destination (required)	Destination of the traffic, which you can configure in the same manner as source.
Service (required)	<p><b>NOTE:</b> Voice over IP services are unavailable for IPv6 policies.</p> <p>Type of traffic:</p> <ul style="list-style-type: none"><li>● <b>any</b>: This option specifies that this rule applies to any type of traffic.</li><li>● <b>tcp</b>: Using this option, you configure a range of TCP port(s) to match the rule to be applied.</li><li>● <b>udp</b>: Using this option, you configure a range of UDP port(s) to match the rule to be applied.</li><li>● <b>service</b>: Using this option, you use one of the pre-defined services (common protocols such as HTTPS, HTTP, and others) as the protocol to match the rule to be applied. You can also specify a network service that you configure by navigating to the <b>Configuration &gt; Advanced Services &gt; Stateful Firewall &gt; Network Services</b> page.</li><li>● <b>protocol</b>: Using this option, you specify a different layer 4 protocol (other than TCP/UDP) by configuring the IP protocol value.</li></ul>
Action (required)	The action that you want the managed device to perform on a packet that matches the specified criteria.

**Table 28: IPv6 Firewall Policy Rule Parameters**

Field	Description
	<ul style="list-style-type: none"> <li><b>permit:</b> Permits traffic matching this rule.</li> <li><b>drop:</b> Drops packets matching this rule without any notification.</li> </ul> <p><b>NOTE:</b> The only actions for IPv6 policy rules are permit or deny; in this release, the managed device cannot perform network address translation (NAT) or redirection on IPv6 packets. You can specify options such as logging, mirroring, or blacklisting (described below).</p>
Log (optional)	Logs a match to this rule. This is recommended when a rule indicates a security breach, such as a data packet on a policy that is meant only to be used for voice calls.
Mirror (optional)	Mirrors session packets to a datapath or remote destination specified in the IPv6 firewall function (see "Session Mirror Destination" in <a href="#">Table 27</a> ). If the destination is an IP address, it must be an IPv4 IP address.
Queue (optional)	The queue in which a packet matching this rule should be placed. Select <b>High</b> for higher priority data, such as voice, and <b>Low</b> for lower priority traffic.
Time Range (optional)	Time range for which this rule is applicable. You configure time ranges in the <b>Configuration &gt; Security &gt; Access Control &gt; Time Ranges</b> page.
Black List (optional)	Automatically blacklists a client that is the source or destination of traffic matching this rule. This option is recommended for rules that indicate a security breach where the blacklisting option can be used to prevent access to clients that are attempting to breach the security.
TOS (optional)	Value of type of service (TOS) bits to be marked in the IP header of a packet matching this rule when it leaves the managed device.
802.1p Priority (optional)	Value of 802.1p priority bits to be marked in the frame of a packet matching this rule when it leaves the managed device.

The following example creates a policy "ipv6-web-only" that allows only web (HTTP and HTTPS) access for IPv6 clients and assigns the policy to the user role "web-guest."



The user role "web-guest" can include both IPv6 and IPv4 policies, although this example only shows configuration of an IPv6 policy.

### Creating an IPv6 Firewall Policy

Follow the procedure below to create an IPv6 firewall policy using the WebUI.

1. In the **Managed Device** node hierarchy, navigate to the **Configuration > Roles & Policies > Policies** tab.
2. Click **+** to create a new policy.
3. Enter **ipv6-web-only** for the **Policy name**.
4. To configure a firewall policy, select **Session** for Policy type.
5. Click **Submit**.
6. Select the **ipv6-web-only** policy.

7. Select **Access Control** option in the **Rule Type** field and click **OK**.
8. Select **IPv6** from the **IP version** drop-down list.
9. Select **Network** from the **Source** drop-down list and enter the following values:
  - a. For **IP**, enter **2002:d81f:f9f0:1000::**.
  - b. For **Netmask**, enter **64** as the prefix-length.
  - c. Under **Service/app**, select **service** from the drop-down list.
  - d. Under **Service alias**, select **svc-http** from the drop-down list.
  - e. Click **Submit**.
10. Click **+** to add a rule that allows HTTPS traffic.
  - a. Under **IP Version** column, select **IPv6**.
  - b. Select **Network** from the **Source** drop-down list.
  - c. For **IP**, enter **2002:d81f:f9f0:1000::**.
  - d. For **Netmask**, enter **64** as the prefix-length.
  - e. Under **Service/app**, select **service** from the drop-down list.
  - f. Select **Ssvc-https** from the scrolling list.
  - g. Click **Submit**.




---

Rules can be reordered using the up and down arrow buttons provided for each rule.

---

11. Click **Pending Changes**.
12. In the **Pending Changes** window, select the check box and click **Deploy changes**.

To create an IPv6 firewall policy using the command-line interface, issue the following commands in config mode:

```
(host) [md] (config)#ip access-list session ipv6-web-only
(host) [md] (config-submode)#ipv6 network 2002:d81f:f9f0:1000::/64 any svc-http permit
(host) [md] (config-submode)#ipv6 network 2002:d81f:f9f0:1000::/64 any svc-https permit
```

### Assigning an IPv6 Policy to a User Role

To assign an IPv6 policy using the WebUI:

1. In the **Managed Device** node hierarchy, navigate to the **Configuration > Roles & Policies > Roles** tab.
2. Click **+** to create a new user role.
3. Enter **web-guest** in the **Name** field.
4. Click **Submit**.
5. Select **web-guest** role.
6. Click **Show Advanced View**.
7. Click **+** in **Roles > web-guest** table.
8. Select **Add an existing session policy** option, in the **Add Policy** popup.
9. Select a policy from the **Policy name** drop-down list.
10. Click **Submit**.
11. Click **Pending Changes**.
12. In the **Pending Changes** window, select the check box and click **Deploy changes**.

To assign an IPv6 policy to a user role via the command-line interface, issue the following command in config mode:

```
(host) [md] (config)#user-role web-guest
(host) [md] (config-submode)#access-list session ipv6-web-only position 1
```

## Understanding DHCPv6 Passthrough/Relay

The managed device forwards DHCPv6 requests from IPv6 clients to the external IPv6 router. On the external IPv6 router, you must configure the managed device's IP address as the DHCP relay. You do *not* need to configure an IP helper address on the managed device to forward DHCPv6 requests.

## Understanding IPv6 Exceptions and Best Practices

The IPv6 best practices are provided below:

- Ensure that you enable IPv6 globally.
- The uplink port must be trusted. This is the same behavior as IPv4.
- Ensure that the `validuser` session ACL does not block IPv6 traffic.
- There must not be any ACLs that drop ICMPv6 or DHCPv6 traffic. It is acceptable to drop DHCPv6 traffic if the deployment uses Stateless Address Auto Configuration (SLAAC) only.
- If an external device provides RA:
  - It is not recommended to advertise too many prefixes in RA.
  - The managed device supports a maximum of four IPv6 user entries in the user table. If a client uses more than four IPv6 addresses at a time, the user table is refreshed with the latest four active entries without disrupting the traffic flow. However, this may have some performance impact.
- Enable **BCMC Optimization** under interface VLAN to drop any random IPv6 multicast traffic. DHCPv6, ND, NS, and RA traffic are not dropped when you enable this option.



---

It is recommended to enable **BCMC Optimization** only if mDNS traffic is not used in the network, as mDNS traffic gets dropped if this option is enabled.

---

- While selecting a source address, the number of common bits between each source address in the list, is checked from the left most bit. This is followed by selection of the source address that has the maximum number of matching bits with the destination address. If more than one source addresses has the same number of matching bits with the destination address, the kernel selects that source address that is most recently configured on the system. It is essential that the administrator/user configures the network appropriately, if a particular VLAN interface needs to be selected as the source. For example, in case of Dot1x authentication the administrator/user can configure the source interface appropriately so that it is selected for authentication process. For more information on IPv6 source address selection, see **RFC 3848**.

ArubaOS does not support the following functions for IPv6 clients:

- The managed device offers limited routing services to IPv6 clients, so it is recommended to use an external IPv6 router for a complete routing experience (dynamic routing).
- VoIP ALG is not supported for IPv6 clients.
- Remote AP supports IPv6 clients in tunnel forwarding mode only. The Remote AP bridge and split-tunnel forwarding modes do not support IPv6 clients. Secure Thin Remote Access Point (STRAP) cannot support IPv6 clients.
- IPv6 Auto configuration and IPv6 Neighbor Discovery mechanisms does not apply to IPv6 tunnels.
- Tunnel Encapsulation Limit, Tunnel-group, and MTU discovery options on IPv6 tunnels are not supported.

The ArubaOS implementation of Link Aggregation Control Protocol (LACP) is based on the standards specified in 802.3ad. LACP provides standardized means for exchanging information with partner systems, to form a Link Aggregation Group (LAG). LACP avoids port channel misconfiguration.

## LACP Overview

Two devices (actor and partner) exchange LACP Data Units (DUs) when forming a port-channel group (LAG). Once multiple ports in the system have the same actor system ID, actor key, partner system ID, and partner key, they belong to the same LAG.

The maximum number of supported port-channels is eight. With the introduction of LACP, this number remains the same.

Two LACP configured devices exchange LACPDUs to form a link aggregation group (LAG). A device is configurable as an active or passive participant. In active mode, the device initiates DUs irrespective of the partner state; passive mode devices respond only to the incoming DUs sent by the partner device. Hence, to form a LAG group between two devices, one device must be an active participant. For detailed information on the LACP commands, see the *ArubaOS 8.0 Command-Line Interface Reference Guide*.

LACPDUs exchange their corresponding system identifier/priority along with their port's key/priority. This information determines the LAG of a given port. The LAG for a port is selected based on its keys. The port is placed in that LAG only when its system ID/key and partner's system ID/key matches the other ports in the LAG (if the group has ports).

## LACP Best Practices and Exceptions

- LACP is disabled by default.
- LACP depends on periodical Tx/Rx of LACP Data Units (LACPDUs). Any failure detected at a port can be removed from the LAG. Failure detection period depends on the configured timeout which can either be short or long.
- The maximum LAG supported per system is eight groups; each group can be created statically or through LACP.
- Each LAG can have up to eight member ports.
- The LAG group identification (ID) range is 0–7 for both static (port-channel) and LACP groups.
- When a port is added to a LACP LAG, it inherits the port-channel's properties such as, VLAN membership, trunk status, and so on.
- When a port is added to a LACP LAG, the port's property (like speed) is compared to the existing port property. If there is a mismatch, the command is rejected.
- The LACP commands cannot be configured on a port that is already a member of a static port-channel. Similarly, if the group assigned in the command **lACP group <number>** already contains static port members, the command is rejected.
- The port uses the group number as its actor admin key.
- All ports use the **long**(90 seconds) timeout value by default.
- The output of the command **show interface port-channel <port-channel ID>** indicates if the LAG is created by LACP (dynamic) or static configuration. If the LAG is created through LACP, you cannot add or delete any ports under that port channel. All other commands are allowed.

# Configuring LACP

## Configuring LACP

### In the CLI

1. Enable LACP and configure the per-port specific LACP.

```
(host) [mynode] (config) #interface gigabitethernet <slot>/<module>/<port>
```

2. Configure LACP group and mode.

```
(host) [mynode] (config-submode) #lACP group <id> mode {active | passive}
```

- **group <id>** range is 0–7.
- **Active mode**—the interface is in an active negotiating state. LACP runs on any link that is configured to be in the active state. The port in an active mode also automatically initiates negotiations with other ports by initiating LACP packets.
- **Passive mode**—the interface is *not* in an active negotiating state. LACP runs on any link that is configured in a passive mode. The port in a passive mode responds to negotiations requests from other ports that are in an active mode. Ports in passive mode respond to LACP packets.



---

A port in passive mode cannot set up a port channel (LAG group) with another port in a passive mode.

---

3. Set the timeout for the LACP session. The timeout value is the amount of time that a port-channel interface waits for a LACPDU from the remote system before terminating the LACP session. The default long timeout value is 90 seconds; short is 3 seconds.

```
(host) [mynode] (config-submode) #lACP timeout {long | short}
```

4. Set the port priority.

```
(host) [mynode] (config-submode) #lACP port-priority <value>
```

The higher the priority value the lower the priority. The range is 1-65535 and the default is 255.

5. Save the configuration.

```
(host) [mynode] (config-submode) #write memory
```

6. View your LACP neighbor.

The port uses the group number +1 as the “actor admin key”. All the ports use the long timeout value (90 seconds) by default.

```
(host) [mynode] (config-submode) #show lACP <id> neighbor
```

When a port in a LAG is misconfigured (the partner device is different than the other ports), or it the neighbor timesout or if it cannot exchange LACPDUs with the partner, the port status is displayed as “DOWN” (see the following example):

```
(host) [mynode] (config-submode) #show lACP <id> internal
```

### In the WebUI

1. In the **Managed Network** node hierarchy, navigate to the **Configuration > Interfaces > Ports** page. In the **Port Channel** table, click **+** to open the **New Port Channel** dialog.
2. In the **New Port Channel** dialog, select a port channel ID from the drop-down list and click **OK**.
3. In the **Port ID** section, select **LACP** from the **Protocol** drop-down list.
4. Select **Active** in **LACP mode**.
5. Click **Submit**.

6. Click **Pending Changes**.

7. In the **Pending Changes** window, select the check box and click **Deploy changes**.



---

For information on configuring LACP on 220 Series and 270 Series access points, see [Link Aggregation Support on page 549](#)

---

## LACP Sample Configuration

The following sample configuration is for gigabitethernet port/slot 0/1:

```
(host)[mynode] (config) #interface gigabitethernet 0/0/4
(host)[mynode] (config-submode)#lACP group 1 mode active
(host)[mynode] (config-submode)#lACP timeout long
(host)[mynode] (config-submode)#lACP port-priority 2
(host)[mynode] (config-submode)#write memory
```

Saving Configuration...

Partial configuration for /mm/mynode

```
-----
Contents of : /flash/config/partial/0/p=sc=mynode.cfg
interface gigabitethernet 0/0/4
lACP group 1 mode active
lACP port-priority 2
lACP timeout long
!
Configuration Saved
```



OSPFv2 (Open Shortest Path First) is a dynamic Interior Gateway routing Protocol (IGP) based on IETF RFC 2328. The OSPF uses the shortest or fastest routing path. Aruba's implementation of OSPFv2 allows Aruba Mobility Master and managed devices to deploy effectively in a Layer 3 topology. Aruba Mobility Master and managed devices can act as default gateway for all clients and forward user packets to the upstream router. The OSPF on the Mobility Master can be used to redistribute branch routes into corporate OSPF domain. The information on this chapter is in the following sections:

- [Understanding OSPF Deployment Best Practices and Exceptions on page 161](#)
- [Understanding OSPFv2 by Example using a WLAN Scenario on page 162](#)
- [Understanding OSPFv2 by Example using a Branch Scenario on page 163](#)
- [Configuring OSPF on page 165](#)
- [Sample Topology and Configuration on page 166](#)

## Understanding OSPF Deployment Best Practices and Exceptions

OSPF is a robust routing protocol addressing various link types and deployment scenarios. The Aruba implementation applies to two main use cases; WLAN Scenarios and Branch Scenario.

- OSPF is disabled by default.
- Aruba Mobility Master supports only one OSPF instance.
- Convergence takes between 5 and 15 seconds.
- All area types are supported.
- Multiple configured areas are supported.
- An Aruba Mobility Master can act as an ABR (Area border router).
- OSPF supports VLAN and GRE tunnel interfaces.
- To run OSPF over IPsec tunnels, a Layer 3 GRE tunnel is configured between two routers with GRE destination addresses as the inner address of the IPsec tunnel. OSPF is enabled on the Layer 3 GRE tunnel interface, and all of the OSPF control packets undergo GRE encapsulation before entering the IPsec tunnels. The default MTU value for a Layer 3 GRE tunnel in an Aruba Mobility Master is 1100. When running OSPF over a GRE tunnel between an Aruba Mobility Master and another vendor's router, the MTU values must be the same on both sides of the GRE tunnel.

The following table provides information on the maximum OSPF routes supported for various platforms:

**Table 29:** Maximum OSPF Routes

Platform	Branches	Routes
7005	4K	4K
7008	4K	4K
7210	8K	8K

Platform	Branches	Routes
7220	16K	16K
7240	32K	32K

Below are some guidelines regarding deployment and topology for this release of OSPFv2.

- In the WLAN scenario upstream router, configure only the interface connected to the stand-alone controller or the managed device in the same area. This will minimize the number of local subnet addresses advertised by the upstream router to the stand-alone controller or the managed device.
- Use the upstream router as the designated router (DR) for the link/interface between the stand-alone controller or the managed device and the upstream router.
- The default MTU value for a Layer 3 GRE tunnel in an Aruba Mobility Master, managed device or stand-alone controller is 1100. When running OSPF over a GRE tunnel between an Aruba device and another vendor's router, the MTU values must be the same on both sides of the GRE tunnel.
- Do not enable OSPF on any uplink/WAN interfaces on the managed device. Enable OSPF only on the Layer 3 GRE tunnel connecting the Mobility Master.
- Use only one physical port in the uplink VLAN interface that is connecting to the upstream router. This will prevent broadcasting the protocol PDUs to other ports and hence limit the number of adjacencies on the uplink interface to only one.

## Understanding OSPFv2 by Example using a WLAN Scenario

In the WLAN scenario, the Aruba Mobility Master acts as a default gateway for all the clients, and talks to one or two upstream routers for redundancy. Mobility Master advertises all the user subnet addresses as stub addresses to the routers via LSAs.




---

Totally stub areas see only default route and to the areas themselves.

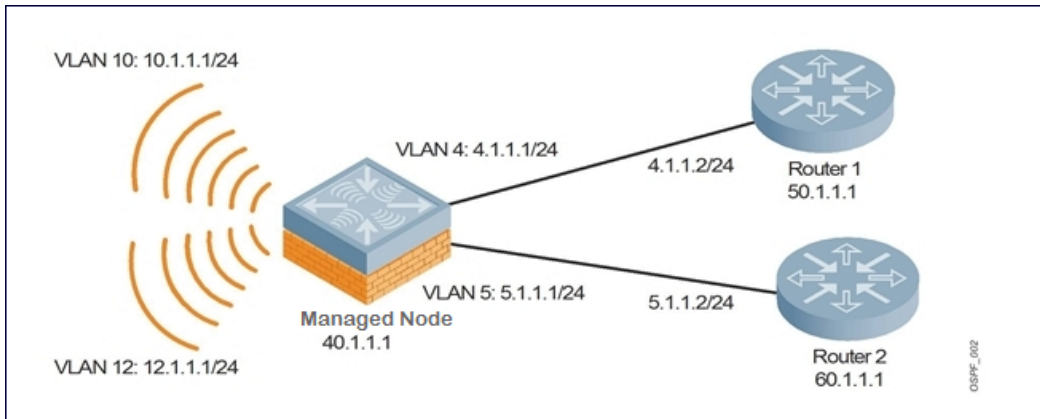
---

### WLAN Topology

Mobility Master ([Figure 18](#)) is configured with VLAN 10 and VLAN 12 as user VLANs. These VLANs have clients on the subnets, and Mobility Master is the default router for those clients. VLAN 4 and VLAN 5 both have OSPF enabled. These interfaces are connected to upstream routers (Router 1 and Router 2). The OSPF interface cost on VLAN 4 is configured lower than VLAN 5. The IDs are:

- Aruba managed device— 40.1.1.1
- Router 1— 50.1.1.1
- Router 2— 60.1.1.1

**Figure 18** WLAN OSPF Topology



Based on the cost of the uplink interface, the default route from one of the upstream routers is installed in the forwarding information base (FIB) by the routing information base/route table manager (RIB/RTM) module.

## WLAN Routing Table

View the Mobility Master routing table using the **show ip route** command:

```
(host) [mynode] #show ip route

Codes: C - connected, O - OSPF, R - RIP, S - static
       M - mgmt, U - route usable, * - candidate default
```

Below is the routing table for Router 1:

```
(router1) #show ip route

O    10.1.1.0/24 [1/0] via 4.1.1.1
O    12.1.1.0/24 [1/0] via 4.1.1.1
C    4.1.1.0 is directly connected, VLAN4
```

Below is the routing table for Router 2:

```
(router2) #show ip route

O    10.1.1.0/24 [2/0] via 5.1.1.1
O    12.1.1.0/24 [2/0] via 5.1.1.1
C    5.1.1.0 is directly connected, VLAN5
```

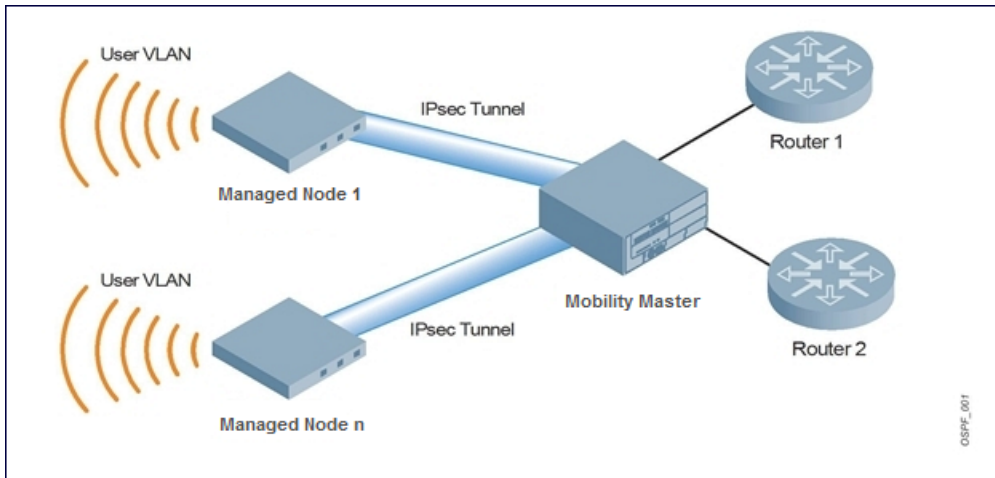
## Understanding OSPFv2 by Example using a Branch Scenario

The branch office scenario has a number of remote branch offices with managed devices talking to a central office via a Mobility Master using site-to-site VPN tunnels or IPsec tunnels. The central office Mobility Master is in turn talking to the upstream routers (see [Figure 19](#)). In this scenario, the default route is normally pointed to the uplink router, in many cases the ISP. Configure the area as stub so that inter-area routes are also advertised enabling the managed device in the branch office to reach the corporate subnets.

## Branch Topology

All the OSPF control packets exchanged between the managed devices and Mobility Master undergo GRE encapsulation before entering the IPsec tunnels. The managed devices in the branch offices advertise all the user subnet addresses to Mobility Master as stub addresses in router LSA. Mobility Master in turn forwards those router LSAs to the upstream routers.

**Figure 19** Branch OSPF Topology



All the managed devices in the branch office, Mobility Master in the central office, and the upstream routers are part of a stub area. Since the OSPF packets follow GRE encapsulation over IPsec tunnels, Mobility Master can be any vendor's VPN concentrator. Regardless, the managed devices in the branch office will operate with other vendors seamlessly.

In [Figure 19](#), the managed device is configured using VLAN 14 and VLAN 15. Layer 3 GRE tunnel is configured with IP address 20.1.1.1/24 and OSPF is enabled on the tunnel interface.

In the Central office Mobility Master, OSPF is enabled on VLAN interfaces 4, 5, and the Layer 3 GRE tunnel interface (configured with IP address 20.1.1.2/24). OSPF interface cost on VLAN 4 is configured lower than VLAN 5.

## Branch Routing Table

View the branch office managed device routing table using the **show ip route** command:

```
(host) [md] #show ip route

Codes: C - connected, O - OSPF, R - RIP, S - static
       M - mgmt, U - route usable, * - candidate default
```

The routing table for Mobility Master is below:

```
(host) [mynode] #show ip route

Gateway of last resort is 4.1.1.2 to network 0.0.0.0

O*   0.0.0.0/0 [1/0] via 4.1.1.2*
O    14.1.1.0/24 [1/0] via 30.1.1.1*
O    15.1.1.0/24 [1/0] via 30.1.1.1*
C    4.1.1.0 is directly connected, VLAN4
C    5.1.1.0 is directly connected, VLAN5
C    20.1.1.0 is directly connected, Tunnel 1
```

The routing table for Router 1 is below:

```
(router1) #show ip route

O    14.1.1.0/24 [1/0] via 4.1.1.1
O    15.1.1.0/24 [1/0] via 4.1.1.1
C    4.1.1.0 is directly connected, VLAN4
```

The routing table for Router 2 is below:

```
(router2) #show ip route
```

```
O 14.1.1.0/24 [1/0] via 5.1.1.1
O 15.1.1.0/24 [1/0] via 5.1.1.1
C 5.1.1.0 is directly connected, VLAN5
```

## Configuring OSPF

To configure general OSPF settings from the OSPF tab, perform the following steps:

1. In the **Mobility Master** node hierarchy, navigate to the **Configuration > Interfaces > OSPF** page.
2. To enable OSPF, Select **Enabled** in the **Enable OSPF** field.
3. Configure the other OSPF interface settings in the respective fields.
4. To add an OSPF area, click the **+** icon in the **Area** table and specify the appropriate values.
5. To add an excluded subnet in the **Excluded Subnet** table, click the **+** icon and specify the appropriate values.
6. Click **Submit**.
7. Click **Pending Changes**.
8. In the **Pending Changes** window, select the check box and click **Deploy changes**.

OSPF monitoring is available from an IP Routing sub-section (**Controllers > Interfaces > IP Routes**). Select the **IP Routes** accordion to view both Static and OSPF routes .

## Exporting VPN Client Addresses to OSPF

You can configure VPN client addresses so that they can be exported to OSPF and be advertised as host routes (/32). Exporting applies to any VPN client address regardless of how it is assigned.

### In the WebUI

1. In the **Mobility Master** node hierarchy, navigate to the **Configuration > System > Profiles > Wireless LAN > VPN Authentication > default** page.



---

For Instant AP, RAP and CAP, you can edit the respective default profiles (default-iap, default-rap, and default-cap)

---

2. (Optional) Select the **Export VPN IP address as a route** check box. Regardless of how an authentication server is contacted, selecting this option causes any VPN client address to be exported to OSPF using IPC. Note that the Framed-IP-Address attribute is assigned the IP address as long as any server returns the attribute. The Framed-IP-Address value always has a higher priority than the local address pool.
3. Click **Save**.
4. Click **Pending Changes**.
5. In the **Pending Changes** window, select the check box and click **Deploy changes**.

### In the CLI

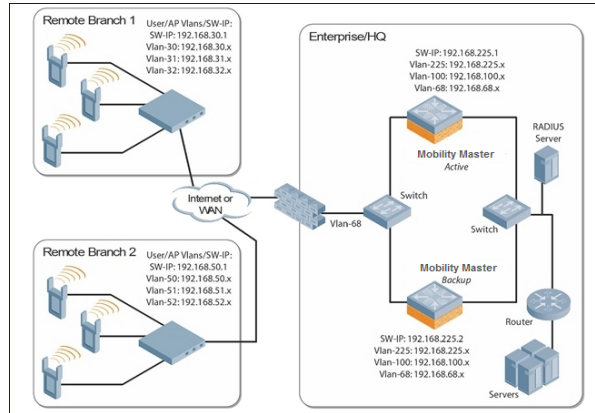
```
(host) [mynode] (config) #aaa authentication vpn default
(host) [mynode] (VPN Authentication Profile "default") #
(host) [mynode] (VPN Authentication Profile "default") # export-route
```

Use the **show ip ospf** database command to show LSA types that are generated.

## Sample Topology and Configuration

The figure below displays a sample OSPF topology followed by sample configurations of the Remote Branch 1, Remote Branch 2, and the Central Office Mobility Master (Active and Backup).

**Figure 20** Sample OSPF Topology



### Remote Branch 1

```
controller-ip vlan 30
vlan 16
vlan 30
vlan 31
vlan 32
interface gigabitethernet 0/0/1
    description "GE0/0/1"
    trusted
    switchport access vlan 16
!
interface gigabitethernet 0/0/2
    description "GE0/0/2"
    trusted
    switchport access vlan 30
!
interface gigabitethernet 0/0/3
    description "GE0/0/3"
    trusted
    switchport access vlan 31
!
interface gigabitethernet 0/0/4
    description "GE0/0/4"
    trusted
    switchport access vlan 32
!
interface vlan 16
    ip address 192.168.16.251 255.255.255.0
!
interface vlan 30
    ip address 192.168.30.1 255.255.255.0
!
interface vlan 31
    ip address 192.168.31.1 255.255.255.0
```

```

!
interface vlan 32
    ip address 192.168.32.1 255.255.255.0
!
uplink wired priority 202
uplink cellular priority 201
uplink wired vlan 16
interface tunnel 2003
    description "Tunnel Interface"
    ip address 2.0.0.3 255.0.0.0
    tunnel source 192.168.30.1
    tunnel destination 192.168.68.217
    trusted
    ip ospf area 10.10.10.10
!
ip default-gateway 192.168.16.254
ip route 192.168.0.0 255.255.0.0 null 0
!
router ospf
router ospf router-id 192.168.30.1
router ospf area 10.10.10.10 stub
router ospf redistribute vlan 30-32

```

## Remote Branch 2

```

controller-ip vlan 50
!
vlan 20
vlan 50
vlan 51
vlan 52
!
interface gigabitethernet 0/0/1
    description "GE0/0/1"
    trusted
    switchport access vlan 20
!
interface gigabitethernet 0/0/2
    description "GE0/0/2"
    trusted
    switchport access vlan 50
!
interface gigabitethernet 0/0/3
    description "GE0/0/3"
    trusted
    switchport access vlan 51
!
interface gigabitethernet 0/0/4
    description "GE10/0/4"
    trusted
    switchport access vlan 52
!
interface vlan 20
    ip address 192.168.20.1 255.255.255.0
!
interface vlan 50
    ip address 192.168.50.1 255.255.255.0
!
interface vlan 51
    ip address 192.168.51.1 255.255.255.0
!
interface vlan 52

```

```

        ip address 192.168.52.1 255.255.255.0
    !
    uplink wired priority 206
    uplink cellular priority 205
    uplink wired vlan 20
    interface tunnel 2005
        description "Tunnel Interface"
        ip address 2.0.0.5 255.0.0.0
        tunnel source 192.168.50.1
        tunnel destination 192.168.68.217
        trusted
        ip ospf area 10.10.10.10
    !
    ip default-gateway 192.168.20.254
    ip route 192.168.0.0 255.255.0.0 null 0
    !
    router ospf
    router ospf router-id 192.168.50.1
    router ospf area 10.10.10.10 stub
    router ospf redistribute vlan 50-52

```

## Mobility Master—Active

```

localip 0.0.0.0 ipsec db947e8dlb383813a4070ab0799fa6246b80fc5cfcc3268f
controller-ip vlan 225
vlan 68
vlan 100
vlan 225
!
interface gigabitethernet 0/0/1
    description "GE0/0/1"
    trusted
    switchport access vlan 225
!
interface gigabitethernet 0/0/2
    description "GE0/0/2"
    trusted
    switchport access vlan 100
!
interface gigabitethernet 10/0/31
    description "GE0/0/4"
    trusted
    switchport access vlan 68
!
interface vlan 68
    ip address 192.168.68.220 255.255.255.0
!
interface vlan 100
    ip address 192.168.100.1 255.255.255.0
!
interface vlan 225
    ip address 192.168.225.2 255.255.255.0
!
interface tunnel 2003
    description "Tunnel Interface"
    ip address 2.1.0.3 255.0.0.0
    tunnel source 192.168.225.2
    tunnel destination 192.168.30.1
    trusted
    ip ospf area 10.10.10.10
!
interface tunnel 2005

```



```

        description "Tunnel Interface"
        ip address 2.1.0.5 255.0.0.0
        tunnel source 192.168.225.2
        tunnel destination 192.168.50.1
        trusted
        ip ospf area 10.10.10.10
    !
master-redundancy
    master-rrp 2
    peer-ip-address 192.168.68.221 ipsec password123
!
vrrp 1
    priority 120
    authentication password123
    ip address 192.168.68.217
    vlan 68
    preempt
    tracking vlan 68 sub 40
    tracking vlan 100 sub 40
    tracking vlan 225 sub 40
    no shutdown
!
vrrp 2
    priority 120
    ip address 192.168.225.9
    vlan 225
    preempt
    tracking vlan 68 sub 40
    tracking vlan 100 sub 40
    tracking vlan 225 sub 40
    no shutdown
!
ip default-gateway 192.168.68.1
ip route 192.168.0.0 255.255.0.0 null 0

router ospf
router ospf router-id 192.168.225.1
router ospf area 10.10.10.10 stub
router ospf redistribute vlan 100,225
!

```

## Mobility Master—Backup

```

localip 0.0.0.0 ipsec db947e8d1b383813a4070ab0799fa6246b80fc5cfcc3268f
controller-ip vlan 225
!
interface gigabitethernet 0/0/1
    description "GE0/0/1"
    trusted
    switchport access vlan 225
!
interface gigabitethernet 0/0/2
    description "GE0/0/2"
    trusted
    switchport access vlan 100
!
interface gigabitethernet 0/0/31
    description "GE0/0/3"
    trusted
    switchport access vlan 68
!
interface vlan 68

```

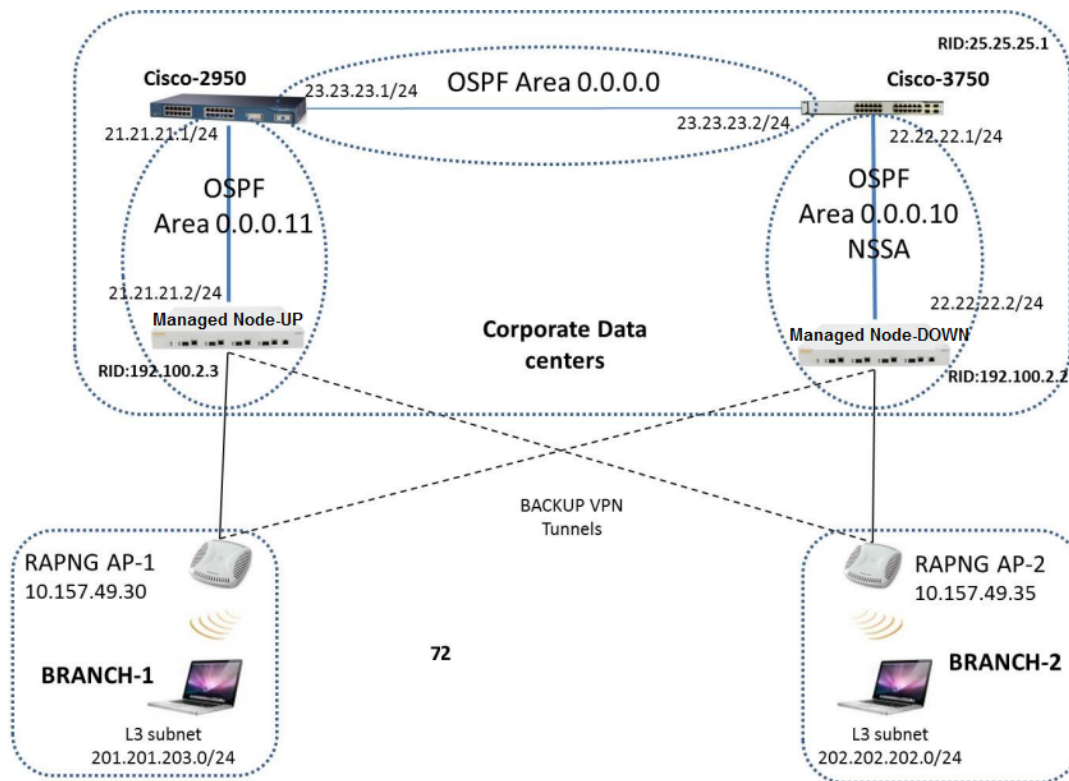
```

        ip address 192.168.68.221 255.255.255.224
    !
interface vlan 100
    ip address 192.168.100.5 255.255.255.0
    !
interface vlan 225
    ip address 192.168.225.1 255.255.255.0
    !
interface tunnel 2003
    description "Tunnel Interface"
    ip address 2.1.0.3 255.0.0.0
    tunnel source 192.168.225.1
    tunnel destination 192.168.30.1
    trusted
    ip ospf area 10.10.10.10
    !
interface tunnel 2005
    description "Tunnel Interface"
    ip address 2.1.0.5 255.0.0.0
    tunnel source 192.168.225.1
    tunnel destination 192.168.50.1
    trusted
    ip ospf area 10.10.10.10
    !
master-redundancy
    master-rrrp 2
    peer-ip-address 192.168.68.220 ipsec password123
    !
vrrp 1
    priority 99
    authentication password123
    ip address 192.168.68.217
    vlan 68
    tracking vlan 68 sub 40
    tracking vlan 100 sub 40
    tracking vlan 225 sub 40
    no shutdown
    !
vrrp 2
    priority 99
    ip address 192.168.225.9
    vlan 225
    tracking vlan 68 sub 40
    tracking vlan 100 sub 40
    tracking vlan 225 sub 40
    no shutdown
    !
ip default-gateway 192.168.68.1
ip route 192.168.0.0 255.255.0.0 null 0
    !
router ospf
router ospf router-id 192.168.225.1
router ospf area 10.10.10.10 stub
router ospf redistribute vlan 100,225
    !

```

The following figure displays how the managed device is configured for Instant AP VPN for different OSPF cases.

**Figure 21** Managed Device Not-So-Stubby-Area (NSSA) and Normal Area



## Topology

- Area-10 is NSSA (Not-So-Stubby Area)
- Area-11 is Normal area.
- RAPNG AP-1 is configured to have a UP managed device as its primary managed device and a DOWN as secondary managed device.
- RAPNG AP-2 is configured to have a DOWN as its primary managed device and a UP as secondary managed device.
- RAPNG AP-1 is configured to have a 201.201.203.0/24 L3-distributed network.
- RAPNG AP-2 is configured to have a 202.202.202.0/24 L3-distributed network.

## Observation

- UP managed device will send Type-5 LSA (External LSA) of VPN route 201.201.203.0/24 to its upstream router, Cisco-3750.
- DOWN managed device will send Type-7 LSA (NSSA) of VPN route 202.202.202.0/24 to its upstream router, Cisco-2950.
- UP managed device will send a Type-4 asbr-summary LSA.

## Configuring UP Managed Device

```
interface vlan 21
ip address 21.21.21.2 255.255.255.0
ip ospf area 0.0.0.11
!
router ospf
router ospf area 0.0.0.11
router ospf redistribute rapng-vpn
!
```

The following commands display the configuration and run time protocol details on the UP managed device:

**(host) [mynode]#show ip route**

```
Codes: C - connected, O - OSPF, R - RIP, S - static
M - mgmt, U - route usable, * - candidate default, V - RAPNG VPN
Gateway of last resort is Imported from DHCP to network 0.0.0.0 at cost 10
Gateway of last resort is Imported from CELL to network 0.0.0.0 at cost 10
Gateway of last resort is Imported from PPPOE to network 0.0.0.0 at cost 10
Gateway of last resort is 10.15.231.185 to network 0.0.0.0 at cost 1
S*   0.0.0.0/0 [1/0] via 10.15.231.185*
O    10.15.228.0/27 [333/0] via 21.21.21.1*
O    12.12.12.0/25 [0/0] via 21.21.21.1*
O    22.22.22.0/24 [3/0] via 21.21.21.1*
O    23.23.23.0/24 [2/0] via 21.21.21.1*
O    25.25.25.0/24 [333/0] via 21.21.21.1*
S    192.100.3.0/24 [1/0] via 192.100.2.1*
S    192.100.4.0/24 [1/0] via 192.100.2.1*
S    192.100.5.0/24 [1/0] via 192.100.2.1*
S    192.100.6.0/24 [1/0] via 192.100.2.1*
S    192.100.7.0/24 [1/0] via 192.100.2.1*
S    192.100.8.0/24 [1/0] via 192.100.2.1*
S    192.100.9.0/24 [1/0] via 192.100.2.1*
S    192.100.10.0/24 [1/0] via 192.100.2.1*
S    192.100.11.0/24 [1/0] via 192.100.2.1*
S    192.100.12.0/24 [1/0] via 192.100.2.1*
S    192.100.13.0/24 [1/0] via 192.100.2.1*
S    192.100.14.0/24 [1/0] via 192.100.2.1*
S    192.168.1.0/24 [1/0] via 192.100.2.1*
S    192.169.1.0/24 [1/0] via 192.100.2.1*
S    192.170.1.0/24 [1/0] via 192.100.2.1*
S    192.171.1.0/24 [1/0] via 192.100.2.1*
S    192.172.1.0/24 [1/0] via 192.100.2.1*
S    192.173.1.0/24 [1/0] via 192.100.2.1*
S    192.174.1.0/24 [1/0] via 192.100.2.1*
S    192.175.1.0/24 [1/0] via 192.100.2.1*
S    192.176.1.0/24 [1/0] via 192.100.2.1*
S    192.177.1.0/24 [1/0] via 192.100.2.1*
S    192.178.1.0/24 [1/0] via 192.100.2.1*
S    192.179.1.0/24 [1/0] via 192.100.2.1*
V    201.201.203.0/26 [10/0] ipsec map
O    202.202.202.0/29 [0/0] via 21.21.21.1*
C    192.100.2.0/24 is directly connected, VLAN2
C    10.15.231.184/29 is directly connected, VLAN1
C    172.16.0.0/24 is directly connected, VLAN3
C    21.21.21.0/24 is directly connected, VLAN21
C    5.5.0.2/32 is an ipsec map 10.15.149.30-5.5.0.2
```

**(host) [mynode]#show ip ospf database**

OSPF Database Table

Area ID	LSA Type	Link ID	Adv Router	Age	Seq#	Checksum
0.0.0.11	ROUTER	21.21.21.1	21.21.21.1	178	0x80000017	0xca50
0.0.0.11	ROUTER	192.100.2.3	192.100.2.3	1406	0x80000007	0x2253
0.0.0.11	NETWORK	21.21.21.1	21.21.21.1	178	0x80000003	0xdf6d
0.0.0.11	IPNET_SUMMARY	22.22.22.0	21.21.21.1	178	0x80000003	0x7e38
0.0.0.11	IPNET_SUMMARY	23.23.23.0	21.21.21.1	178	0x80000003	0x5064
0.0.0.11	ASBR_SUMMARY	25.25.25.1	21.21.21.1	178	0x80000003	0xefbc
0.0.0.11	ASBR_SUMMARY	192.100.2.3	192.100.2.3	1412	0x80000002	0xa85d
N/A	AS_EXTERNAL	10.15.228.0	25.25.25.1	1014	0x8000000e	0xea43
N/A	AS_EXTERNAL	12.12.12.0	25.25.25.1	268	0x80000003	0x433a

N/A	AS_EXTERNAL	25.25.25.0	25.25.25.1	1761	0x80000005	0x3d8d
N/A	AS_EXTERNAL	201.201.203.0	10.15.231.186	3600	0x80000001	0x6690
N/A	AS_EXTERNAL	201.201.203.0	192.100.2.3	1104	0x80000002	0xe4a2
N/A	AS_EXTERNAL	202.202.202.0	25.25.25.1	268	0x80000003	0x4385

(host) [mynode]#show ip ospf neighbor

OSPF Neighbor Table

```

-----
Neighbor ID  Pri  State      Address      Interface
-----
21.21.21.1  1    FULL/DR    21.21.21.1  Vlan

```

## Configuring DOWN Managed Device

```

interface vlan 22
ip address 22.22.22.2 255.255.255.0
ip ospf area 0.0.0.10
!
router ospf
router ospf area 0.0.0.10 nssa
router ospf redistribute rapng-vpn
!

```

The following commands display the configuration and run time protocol details on the DOWN managed device:

(host) [mynode]#show ip route

```

Codes: C - connected, O - OSPF, R - RIP, S - static
M - mgmt, U - route usable, * - candidate default, V - RAPNG VPN
Gateway of last resort is Imported from DHCP to network 0.0.0.0 at cost 10
Gateway of last resort is Imported from CELL to network 0.0.0.0 at cost 10
Gateway of last resort is Imported from PPPOE to network 0.0.0.0 at cost 10
O   0.0.0.0/0 [1/0] via 22.22.22.1*
S   10.0.0.0/8 [1/0] via 10.15.231.177*
O   10.15.228.0/27 [333/0] via 22.22.22.1*
V   12.12.12.0/25 [10/0] ipsec map
O   21.21.21.0/24 [3/0] via 22.22.22.1*
O   23.23.23.0/24 [2/0] via 22.22.22.1*
O   25.25.25.0/24 [333/0] via 22.22.22.1*
V   202.202.202.0/29 [10/0] ipsec map
C   192.100.2.0/24 is directly connected, VLAN2
C   10.15.231.176/29 is directly connected, VLAN1
C   22.22.22.0/24 is directly connected, VLAN22
C   4.4.0.2/32 is an ipsec map 10.15.149.35-4.4.0.2
C   4.4.0.1/32 is an ipsec map 10.17.87.126-4.4.0.1

```

(host) [mynode]#show ip ospf neighbor

OSPF Neighbor Table

```

-----
Neighbor ID  Pri  State      Address      Interface
-----
25.25.25.1  1    FULL/BDR    22.22.22.1  Vlan 22

```

(host) [mynode]#show ip ospf database

OSPF Database Table

```

-----
Area ID      LSA Type      Link ID      Adv Router    Age    Seq#          Checksum
-----
0.0.0.10     ROUTER        25.25.25.1   25.25.25.1   1736   0x800000021   0xb732
0.0.0.10     ROUTER        192.100.2.2  192.100.2.2   500    0x800000005   0x9ad9
0.0.0.10     NETWORK      22.22.22.2   192.100.2.2   500    0x800000004   0x8aeb

```

0.0.0.10	IPNET_SUMMARY	21.21.21.0	25.25.25.1	1990	0x80000003	0xe7bf
0.0.0.10	IPNET_SUMMARY	23.23.23.0	25.25.25.1	1990	0x80000003	0x950d
0.0.0.10	NSSA	0.0.0.0	25.25.25.1	725	0x80000002	0xaab9
0.0.0.10	NSSA	10.15.228.0	25.25.25.1	1228	0x80000010	0xca5f
0.0.0.10	NSSA	12.12.12.0	192.100.2.2	352	0x80000005	0xe8cb
0.0.0.10	NSSA	25.25.25.0	25.25.25.1	1485	0x80000006	0x1fa8
0.0.0.10	NSSA	202.202.202.0	192.100.2.2	352	0x80000005	0xe817
N/A	AS_EXTERNAL	12.12.12.0	192.100.2.2	352	0x80000005	0x28d8
N/A	AS_EXTERNAL	202.202.202.0	192.100.2.2	352	0x80000005	0x2824

## Viewing the Status of Instant AP VPN

### RAPNG AP-1

```
(host) [mynode]# show vpn status
profile name:default
```

```
-----
current using tunnel                :primary tunnel
ipsec is preempt status              :disable
ipsec is fast failover status        :disable
ipsec hold on period                 :600
ipsec tunnel monitor frequency (seconds/packet) :5
ipsec tunnel monitor timeout by lost packet cnt :2
ipsec primary tunnel crypto type     :Cert
ipsec primary tunnel peer address    :10.15.231.186
ipsec primary tunnel peer tunnel ip  :192.100.2.3
ipsec primary tunnel ap tunnel ip    :5.5.0.2
ipsec primary tunnel current sm status :Up
ipsec primary tunnel tunnel status   :Up
ipsec primary tunnel tunnel retry times :2
ipsec primary tunnel tunnel uptime   :1 hour 24 minutes 50 seconds
ipsec backup tunnel crypto type      :Cert
ipsec backup tunnel peer address     :10.15.231.178
ipsec backup tunnel peer tunnel ip   :0.0.0.0
ipsec backup tunnel ap tunnel ip     :0.0.0.0
ipsec backup tunnel current sm status :Init
ipsec backup tunnel tunnel status    :Down
ipsec backup tunnel tunnel retry times :0
ipsec backup tunnel tunnel uptime    :0
```

```
(host)# show datapath route
```

```
Route Table Entries
```

```
-----
Flags: L - Local, P - Permanent, T - Tunnel, I - IPsec, M - Mobile, A - ARP, D - Drop
```

IP	Mask	Gateway	Cost	VLAN	Flags
0.0.0.0	0.0.0.0	10.15.149.25	0	0	
0.0.0.0	128.0.0.0	192.100.2.3	0	0	T
128.0.0.0	128.0.0.0	192.100.2.3	0	0	T
192.168.10.0	255.255.254.0	192.168.10.1	0	3333	D
201.201.203.0	255.255.255.192	0.0.0.0	0	103	LP
10.15.149.24	255.255.255.248	10.15.149.30	0	1	L
10.15.231.186	255.255.255.255	10.15.149.25	0	0	

```
Route Cache Entries
```

```
-----
Flags: L - local, P - Permanent, T - Tunnel, I - IPsec, M - Mobile, A - ARP, D - Drop
```

IP	MAC	VLAN	Flags
202.202.202.6	00:00:00:00:00:00		0 T
192.100.2.3	00:00:00:00:00:00		0 PT
192.168.10.51	10:40:F3:98:80:94		1 PA
192.168.10.1	00:24:6C:C9:27:A3		3333 LP
201.201.203.8	00:26:C6:52:6B:14		103

```

201.201.203.1    00:24:6C:C9:27:A3          103 LP
10.1.1.50       00:00:00:00:00:00          0 T
5.5.0.2         00:24:6C:C9:27:A3          1 LP
10.15.149.30    00:24:6C:C9:27:A3          1 LP
10.15.149.25    00:0B:86:40:93:00          1 A
(host)# show clients
Client List
-----
Name IP Address      MAC Address      OS Network Access Point      Channel Type Role
Signal Speed (mbps)
-----
201.201.203.8  00:26:c6:52:6b:14      149.30  00:24:6c:c9:27:a3  48-      AN      149.30  43
(good) 6(poor)
Info timestamp      :80259

```

## RAPNG AP-3

(host) [mynode]# show vpn status

```

profile name:default
-----
current using tunnel                :primary tunnel
ipsec is preempt status              :disable
ipsec is fast failover status        :disable
ipsec hold on period                 :600
ipsec tunnel monitor frequency (seconds/packet) :5
ipsec tunnel monitor timeout by lost packet cnt :2
ipsec primary tunnel crypto type     :Cert
ipsec primary tunnel peer address    :10.15.231.178
ipsec primary tunnel peer tunnel ip  :192.100.2.2
ipsec primary tunnel ap tunnel ip    :4.4.0.2
ipsec primary tunnel current sm status :Up
ipsec primary tunnel tunnel status   :Up
ipsec primary tunnel tunnel retry times :13
ipsec primary tunnel tunnel uptime   :1 hour 55 minutes 6 seconds
ipsec backup tunnel crypto type      :Cert
ipsec backup tunnel peer address     :10.15.231.186
ipsec backup tunnel peer tunnel ip   :0.0.0.0
ipsec backup tunnel ap tunnel ip     :0.0.0.0
ipsec backup tunnel current sm status :Init
ipsec backup tunnel tunnel status    :Down
ipsec backup tunnel tunnel retry times :0
ipsec backup tunnel tunnel uptime    :0

```

(host) [mynode]# show datapath route

```

Route Table Entries
-----
Flags: L - Local, P - Permanent, T - Tunnel, I - IPsec, M - Mobile, A - ARP, D - Drop
IP          Mask          Gateway          Cost  VLAN  Flags
-----
0.0.0.0     0.0.0.0       10.15.149.33    0     0
0.0.0.0     128.0.0.0     192.100.2.2     0     0 T
128.0.0.0   128.0.0.0     192.100.2.2     0     0 T
192.168.10.0 255.255.254.0 192.168.10.1    0     3333 D
10.15.149.32 255.255.255.248 10.15.149.35    0     1 L
202.202.202.0 255.255.255.248 0.0.0.0         0     203 LP
10.15.231.178 255.255.255.255 10.15.149.33    0     0

Route Cache Entries
-----
Flags: L - local, P - Permanent, T - Tunnel, I - IPsec, M - Mobile, A - ARP, D - Drop
IP          MAC          VLAN          Flags
-----

```

```

-----
202.202.202.1    00:24:6C:C0:41:F2          203 LP
202.202.202.6    08:ED:B9:E1:51:7B          203
192.100.2.2      00:00:00:00:00:00          0 PT
192.168.10.1     00:24:6C:C0:41:F2          3333 LP
201.201.203.8    00:00:00:00:00:00          0 T
10.1.1.50         00:00:00:00:00:00          0 T
192.168.11.7     00:26:C6:52:6B:14          1 PA
4.4.0.2           00:24:6C:C0:41:F2          1 LP
10.13.6.110      00:00:00:00:00:00          0 T
10.15.149.38     00:24:6C:C9:27:CC          1 A
10.15.149.35     00:24:6C:C0:41:F2          1 LP
10.15.149.33     00:0B:86:40:93:00          1 A

```

**(host) [mynode]# show clients**

Client List

```

-----
Name IP Address      MAC Address      OS Network Access Point Channel Type Role
Signal Speed (mbps)
-----
-----
202.202.202.6 08:ed:b9:e1:51:7b 149.35 00:24:6c:c0:41:f2 48- AN 149.35 53
(good) 48(poor)
Info timestamp :80748

```



This chapter describes how to configure an Aruba tunneled node, also known as a wired tunneled node. Aruba tunneled nodes provide access and security using an overlay architecture.

This chapter describes the following topics:

- [Understanding Tunneled Node Configuration on page 177](#)
- [Configuring a Wired Tunneled Node Client on page 178](#)

## Understanding Tunneled Node Configuration

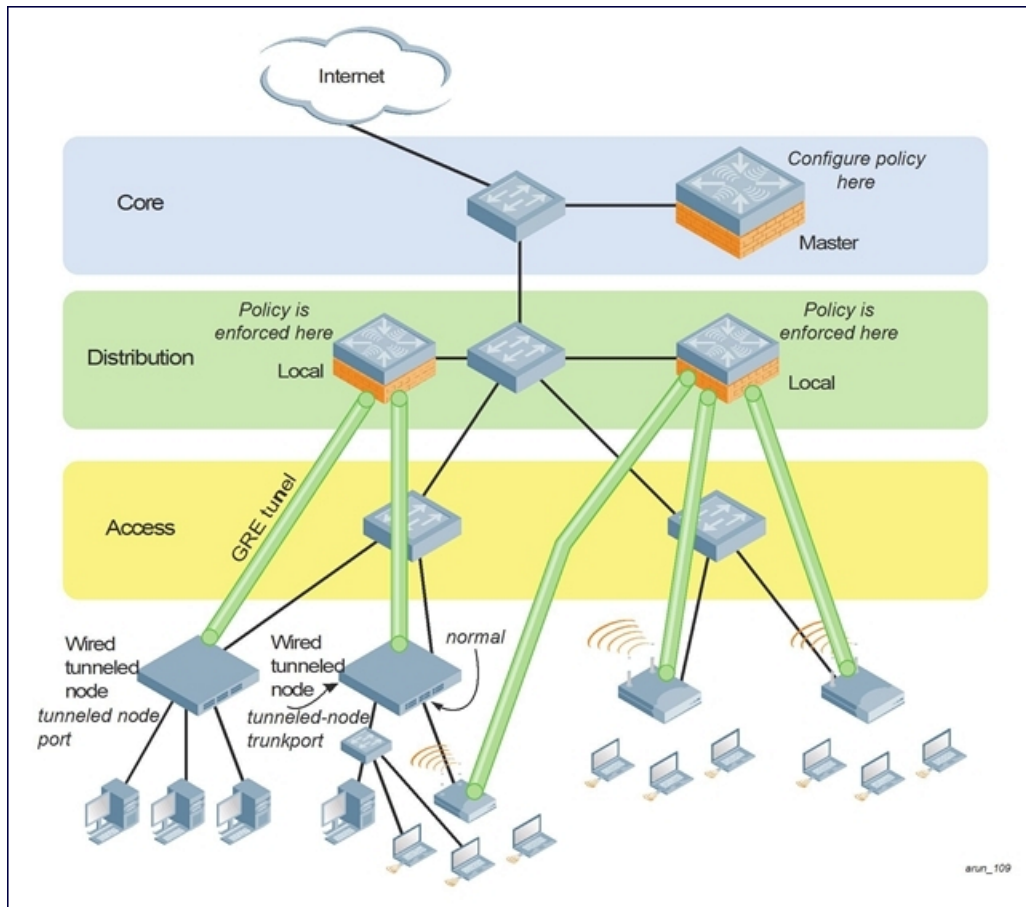
The Aruba tunneled node connects to one or more client devices at the edge of the network and then establishes a secure GRE tunnel to the controlling concentrator server. This approach allows the managed device to support all the centralized security features, such as 802.1X authentication, captive-portal authentication, and stateful firewall. The Aruba tunneled node is required to handle only the physical connection to clients and support for its end of the GRE tunnel.

To support the wired concentrator, the managed device must have a license to terminate access points (APs). No other configuration is required. To configure the Aruba tunneled node, you must specify the IP address of the managed device and identify the ports that are to be used as active tunneled node ports. Tunnels are established between the managed device and each active tunneled node port on the tunneled node. All tunneled node units must be running the same version of software. The tunneled node port can also be configured as a trunk port. This allows customers to have multiple clients on different VLANs that come through the trunk port instead of having clients on a single VLAN.

[Figure 22](#) shows how the tunneled node fits into network operations. Traffic moves through GRE tunnels between the active tunneled node ports and the managed device. Policies are configured on the managed device and enforced on the managed device can run on the same or different systems.

On the managed device, you can assign the same policy to tunneled node user traffic as you would to any untrusted wired traffic. The profile specified by the `aaa authentication wired` command determines the initial role, which contains the policy. The VLAN setting on the concentrator port must match the VLAN that will be used for users at the managed device.

**Figure 22** *Tunneled Node Configuration Operation*



## Configuring a Wired Tunneled Node Client

ArubaOS does not allow a tunneled-node client and tunneled-node server to co-exist on the same managed device at the same time. The managed device must be configured as either a tunneled-node client or a tunneled-node server. By default, the managed device behaves as a tunneled-node server. However, once tunneled-node-server xxx.xxx.xxx.xxx is configured on the managed device, the managed device becomes a tunneled-node client. To remove the tunneled-node client function, use the command **tunneled-node-server 0.0.0.0** to disable the tunneled-node client on the managed device.



This section describes how to configure a tunneled node client. You can use the CLI to complete the configuration steps.

1. Access the Wired tunneled node CLI according to the instructions provided in the Aruba installation guide that shipped with your tunneled node. Console access (9600 8N1) and SSH access are supported.
2. Specify the IP address of the managed device and specify tunnel loop prevention.

```
(host) (mynode) (config) #tunneled-node-address <tnode-ip-address>  
(host) (mynode) (config) #tunnel-loop-prevention
```

3. Access each interface that you want to use, and assign it as a tunneled node port.

```
(host) [mynode] (config) #interface gigabitethernet <slot/module/port>  
(host) [mynode] (config-submode) #tunneled-node-port
```

4. Verify the configuration.

```
(host) [mynode] (config-submode) #exit  
(host) [mynode] (config) #show tunneled-node config
```

## Configuring an Access Port as a Tunneled Node Port

You can configure any port on any managed device as a tunneled node port using the **tunneled-node-port** command. Set the **tunneled-node-address** as the managed device to act as the tunneled node termination point. The **tunneled-node-port** command tells the physical interface to tunnel that traffic to the managed device.

1. Enable portfast on the wired tunneled node.

```
(host) (mynode) (config) #interface gigabitethernet <slot/module/port>
(host) (mynode) (config) #spanning-tree portfast
```

2. Assign a VLAN to the tunneled node port.

```
(host) [mynode] (config-submode) #switchport mode access
(host) [mynode] (config-submode) #switchport access vlan <id>
```

## Configuring a Trunk Port as a Tunneled Node Port

- To enable switchport on the wired tunneled node execute the following commands:

```
(host) [mynode] (config-submode) #switchport mode trunk
```

```
(host) [mynode] (config-submode) #switchport trunk allowed vlan <WORD>
```

- To verify the status of the wired tunneled node execute the following commands:

```
(host) [mynode] (config-submode) #show tunneled-node state
```

```
(host) [mynode] (config-submode) #show tunneled-node config
```

- To check the current usage on the managed device execute the following command:

```
(host) [mynode] #show license-usage ap
```

Each tunneled-node client uses one AP license. Attaching an additional wired client on the tunneled node client does not increment the AP license usage on the managed device.

The ArubaOS software allows you to use an external authentication server or the Mobility Master's internal user database to authenticate clients who need to access the wireless network.

### Authentication Server Overviews

The following sections provide a general overview of the Mobility Master authentication server management:

- [Understanding Authentication Server Best Practices and Exceptions on page 180](#)
- [Understanding Servers and Server Groups on page 180](#)

### Configuring Authentication Servers and Server Groups

The following topics describe the procedures to create and manage external and internal authentication servers and server groups.

- [Configuring Authentication Servers on page 181](#)
- [Managing the Internal Database on page 190](#)
- [Configuring Server Groups on page 191](#)
- [Assigning Server Groups on page 197](#)
- [Configuring Authentication Timers on page 201](#)
- [Authentication Server Load Balancing on page 203](#)

## Understanding Authentication Server Best Practices and Exceptions

- For an external authentication server to process requests from Mobility Master, you must configure the server to recognize the Mobility Master. Refer to the vendor documentation for information on configuring the authentication server.
- To configure Microsoft's IAS and Active Directory, see the following links:
  - <http://technet2.microsoft.com/windowsserver/en/technologies/ias.msp>
  - <http://www.microsoft.com/en-us/server-cloud/windows-server/active-directory.aspx>

## Understanding Servers and Server Groups

Mobility Master supports the following external authentication servers:

- RADIUS (Remote Authentication Dial-In User Service)
- LDAP (Lightweight Directory Access Protocol)
- TACACS+ (Terminal Access Controller Access Control System)
- Windows (For stateful NTLM authentication)



---

A maximum of 128 LDAP, RADIUS, and TACACS servers, each can be configured on a managed device.

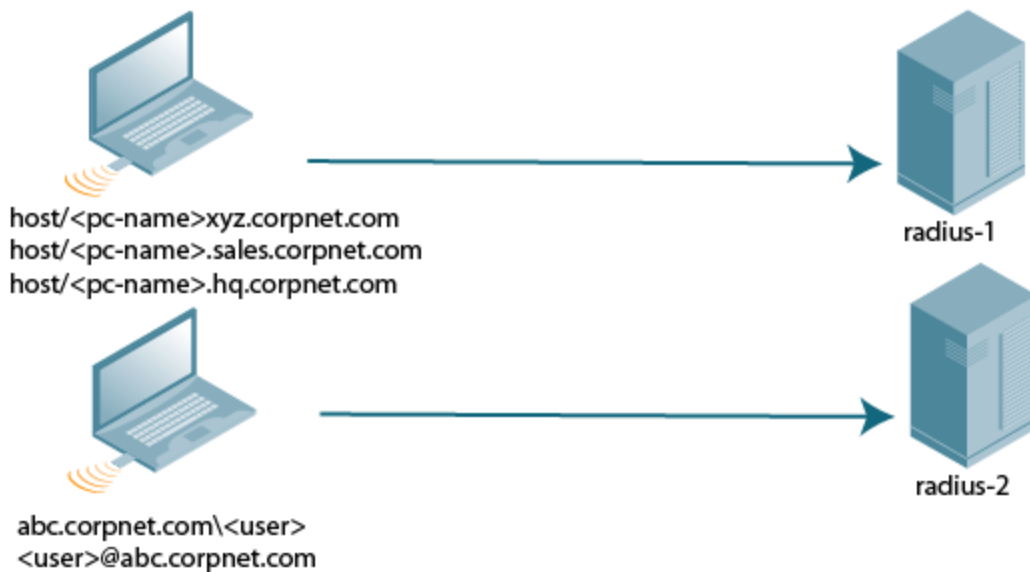
---

Additionally, you can use the internal database to authenticate users by creating entries for users, their passwords, and their default role.

You can create *groups* of servers for specific types of authentication. For example, you can specify one or more RADIUS servers to be used for 802.1X authentication. The list of servers in a server group is an ordered list. This means that the first server in the list is always used unless it is unavailable, in which case the next server in the list is used. You can configure servers of different types in one group. For example, you can include the internal database as a backup to a RADIUS server.

[Figure 23](#) represents a server group named “Radii” that consists of two RADIUS servers, Radius-1 and Radius-2. The server group is assigned to the server group for 802.1X authentication.

**Figure 23** Server Group



Server names are unique. You can configure the same server in multiple server groups. You must configure the server before you can add it to a server group.



---

If you use the internal database for user authentication, use the predefined “Internal” server group.

---

You can also include conditions for server-derived user roles or VLANs in the server group configuration. The server derivation rules apply to all servers in the group.

## Configuring Authentication Servers

This section describes how to configure RADIUS, LDAP, TACACS+ and Windows external authentication servers and the internal database.

This section includes the following information:

- [Configuring a RADIUS Server on page 182](#)
- [RADIUS Service-Type Attribute on page 183](#)
- [Enabling Radsec on RADIUS Servers on page 184](#)
- [Configuring Username and Password for ClearPass Policy Manager Authentication on page 186](#)
- [Configuring an RFC-3576 RADIUS Server on page 186](#)
- [Configuring an LDAP Server on page 187](#)
- [Configuring a TACACS+ Server on page 188](#)
- [Configuring a Windows Server on page 190](#)

## Configuring a RADIUS Server

Follow the procedures below to configure a RADIUS server using the WebUI or CLI.

### Using the WebUI

1. In the **Mobility Master** node hierarchy, navigate to the **Configuration > Authentication > Auth Servers** tab.
2. In the **All Servers** table, click **+** to add a new server.
3. Enter a name for the new server.
4. Enter the IP address for the new server.
5. Select **RADIUS** from the **Type** drop-down list.
6. Click **Apply**.
7. In the **All Servers** table, select the name of the new RADIUS server to configure server parameters.
8. Enter the parameters as described in [Table 30](#). Set **Mode** to **Enabled** to activate the authentication server.
9. Click **Submit**.
10. Click **Pending Changes**.
11. In the **Pending Changes** window, select the check box and click **Deploy changes**.



---

The configuration does not take effect until you perform this step.

---

### Using the CLI

```
(host) [mynode] (config) #aaa authentication-server radius <name>
    host <ipaddr>
    key <psk>
    enable
```

**Table 30: RADIUS Server Configuration Parameters**

Parameter	Description
IP address	IP address or fully qualified domain name (FQDN) of the authentication server. The maximum supported FQDN length is 63 characters. Default: N/A
Auth Port	Authentication port of this server. Default: 1812
Acct Port	Accounting port of this server. Default: 1813
Shared key	Shared secret between the managed device and the authentication server. The maximum length is 128 characters. Default: N/A
Timeout	Maximum time, in seconds, that the managed device waits before timing out the request and resending it. Default: 5 seconds

Parameter	Description
Retransmits	Maximum number of retries sent to the server by the managed device before the server is marked as down. Default: 3
NAS ID	Network Access Server (NAS) identifier to use in RADIUS packets.
NAS IP	The NAS IP address to be sent in RADIUS packets from that server. <b>NOTE:</b> If you define a local NAS IP using the <b>Configuration &gt; Security &gt; Authentication &gt; Servers</b> page and also define a global NAS IP using the <b>Configuration &gt; Security &gt; Authentication &gt; Advanced</b> page, the global NAS IP address takes precedence.
Enable IPv6	Enable or disable IPv6 for this server. Default: Disabled
NAS IPv6	The NAS IPv6 address to be sent in RADIUS packets.
Use MD5	Use MD5 hash of cleartext password. Default: Disabled
Mode	Enables or disables the server. Default: Enabled
Lowercase MAC addresses	Send MAC address with lowercase in the authentication and accounting requests to this server. Default: Disabled
Use IP address for calling station ID	Enables or disables using the IP address for the calling station ID. Default: Disabled
MAC address delimiter	Send MAC address with the following delimiters in the authentication and accounting requests of this server: <ul style="list-style-type: none"> <li>● <b>colon:</b> Send MAC address as XX:XX:XX:XX:XX:XX</li> <li>● <b>dash:</b> Send MAC address as XX-XX-XX-XX-XX-XX</li> <li>● <b>none:</b> Send MAC address as XXXXXXXXXXXX</li> <li>● <b>oui-nic:</b> Send MAC address as XXXXXX-XXXXXX</li> </ul> Default: none
Service-type of FRAMED-USER	Send the service-type as FRAMED-USER instead of LOGIN-USER. For more information, see <a href="#">RADIUS Service-Type Attribute on page 183</a> . Default: Disabled

## RADIUS Service-Type Attribute

Managed devices send the following Service-Type attribute values for RADIUS authentication requests.

**Table 31: RADIUS Service-Type Attributes**

RADIUS Attribute	Authentication Type	Attribute Value
Service-Type	MAC	Call-Check
	802.1X	Framed
	Captive Portal	Login

The service-type-framed-user configuration of the RADIUS server overwrites all the attribute values to Framed irrespective of the authentication type. Existing deployments that depend upon this attribute for their third-party RADIUS integrations should make changes to support these new service types.

## Enabling Radsec on RADIUS Servers

Conventional RADIUS protocol offers limited security. This level of limited security is not sufficient for authentication that takes place across unsecured networks such as the Internet. To address this, the RADIUS over TLS or Radsec enhancement is introduced to ensure RADIUS authentication and accounting data is transmitted safely and reliably across insecure networks. The default destination port for RADIUS over TLS is TCP/2083. Separate ports are not used for authentication, accounting, and dynamic authorization changes.

In a TLS connection, both the managed device (TLS client) and the Radsec server (TLS server) need to authenticate each other using certificates. For the managed device to authenticate the Radsec server:

- The Certificate Authority (CA) certificate should be uploaded as a **Trusted CA** if the Radsec server uses a certificate signed by a CA.
- Self-signed certificates should be uploaded as a **PublicCert** if the Radsec server uses a self-signed certificate.



---

If neither of these certificates are configured, the managed device does not try to establish any connection with the Radsec server, even if Radsec is enabled.

---

The managed device must also send a TLS client certificate to the Radsec server by uploading a certificate on Mobility Master as **ServerCert** and configuring Radsec to accept and use the certificate. If a certificate is not configured, Mobility Master uses the device certificate in its Trusted Platform Module (TPM). In this case, the Aruba device CA that signed the certificate should be configured as a Trusted CA on the Radsec server.



---

When Radsec support is enabled, the default RADIUS shared key is **radsec** and remains the same even if the user configures a different shared key.

---

## In the CLI

```
(host) [mynode] (config) #aaa authentication-server radius <rad_server_name>
enable-radsec
radsec-client-cert-name <name>
radsec-port <radsec-port>
radsec-trusted-cacert-name <radsec-trusted-ca>
radsec-trusted-servercert-name <name>
```

To upload certificates through the CLI, see [Importing Certificates](#).



---

To configure a Radsec server as RFC 3576 server for dynamic authorization (CoA), see [Configuring an RFC-3576 RADIUS Server on page 186](#).

---



## RADIUS Server VSAs

Vendor-Specific Attributes (VSAs) are a method for communicating vendor-specific information between Network Access Servers and RADIUS servers, allowing vendors to support their own extended attributes. You can use Aruba VSAs to derive the user role and VLAN for RADIUS-authenticated clients; however the VSAs must be present on your RADIUS server. This requires that you update the RADIUS dictionary file with the vendor name (Aruba) and/or the vendor-specific code (14823), the vendor-assigned attribute number, and the attribute format (such as string or integer) for each VSA. For more information on VSA-derived user roles, see [Configuring a VSA-Derived Role on page 383](#)

For the current and complete list of all RADIUS VSAs available in the version of ArubaOS currently running on your Mobility Master, access the command-line interface and issue the command **show aaa radius-attributes**.

## RADIUS Server Authentication Codes

A configured RADIUS server returns the following standard response codes.

**Table 32:** RADIUS Authentication Response Codes

Code	Description
0	Authentication OK.
1	Authentication failed : user/password combination not correct.
2	Authentication request timed out : No response from server.
3	Internal authentication error.
4	Bad Response from RADIUS server : verify shared secret is correct.
5	No RADIUS authentication server is configured.
6	Challenge from server. (This does not necessarily indicate an error condition.)

## RADIUS Server Fully Qualified Domain Names

If you define a RADIUS server using the FQDN of the server rather than its IP address, the managed device periodically generates a DNS request and caches the IP address returned in the DNS response. To view the IP address that currently correlates to each RADIUS server FQDN, access the command-line interface in config mode and issue the **show aaa fqdn-server-names** command.

## DNS Query Intervals

If you define a RADIUS server using the FQDN of the server rather than its IP address, the managed device periodically generates a DNS request and caches the IP address returned in the DNS response. DNS requests are sent every 15 minutes by default.

You can use either the WebUI or the CLI to configure how often a DNS request is generated to cache the IP address for a RADIUS server identified via its fully qualified domain name (FQDN).

### Using the WebUI

1. In the **Mobility Master** node hierarchy, navigate to the **Configuration > Authentication > Advanced** page.

2. Under **DNS Query Interval**, enter a new DNS query interval, from 1-1440 minutes, in the **DNS Query Interval** (min) field.
3. Click **Submit**.
4. Click **Pending Changes**.
5. In the **Pending Changes** window, select the check box and click **Deploy changes**.

### Using the CLI

```
(host) [mynode] (config) #aaa dns-query-interval <minutes>
```

## Configuring Username and Password for ClearPass Policy Manager Authentication

Authentication to ClearPass Policy Manager is enhanced to use configurable usernames and passwords instead of a support password. The support password is vulnerable to attacks as the server certificate presented by ClearPass Policy Manager server is not validated.

## Configuring an RFC-3576 RADIUS Server

You can configure a RADIUS server to send user disconnect, change-of-authorization (CoA), and session timeout messages as described in RFC 3576, "Dynamic Authorization Extensions to Remote Dial In User Service (RADIUS)."



---

For Remote AP, RADIUS CoA is supported on tunnel and split-tunnel forwarding modes only.

---

---

For Campus AP, RADIUS CoA is supported on tunnel and decrypt-tunnel forwarding modes only.

---

The disconnect, session timeout, and change-of-authorization messages sent from the server to a managed device contains information to identify the user for which the message is sent. Mobility Master supports the following attributes for identifying the users who authenticate with an RFC 3576 server:

- **user-name**: name of the user to be authenticated
- **framed-ip-address**: user's IP address
- **calling-station-id**: phone number of a station that originated a call
- **accounting-session-id**: unique accounting ID for the user session.

If the authentication server sends both supported and unsupported attributes to a managed device, the unknown or unsupported attributes are ignored. If no matching user is found, a *503: Session Not Found* error message is sent back to the RFC 3576 server.

### Using the WebUI

1. In the **Mobility Master** node hierarchy, navigate to the **Configuration > Authentication > Auth Servers** page.
2. To define a new RFC 3576 RADIUS server click **+** under **All Servers**. Set the **Type** to **RFC** and enter the **IP address** for the server. Click **Apply**.
3. Select the server from the **All Servers** list to configure server parameters.
4. Enter the server authentication key into the **Key** and **Retype key** fields.
5. Click **Submit**.
6. Click **Pending Changes**.
7. In the **Pending Changes** window, select the check box and click **Deploy changes**.



---

The configuration does not take effect until you perform this step.

---

## Using the CLI

```
(host) [mynode] (config) #aaa rfc-3576-server <ipaddr>
    clone <source>
    key <psk>
    no ...
```

## Configuring an RFC-3576 RADIUS Server with Radsec

### Using the CLI

```
(host) [mynode] (config) #aaa rfc-3576-server <ipaddr>
    enable-radsec
    no ...
```

## Configuring an LDAP Server

[Table 33](#) describes the parameters you configure for an LDAP server.

**Table 33:** LDAP Server Configuration Parameters

Parameter	Description
Host	IP address of the LDAP server. Default: N/A
Admin-DN	Distinguished name for the admin user who has read/search privileges across all the entries in the LDAP database (the user does need write privileges, but will be able to search the database, and read attributes of other users in the database).
Admin Password	Password for the admin user. Default: N/A
Allow Clear-Text	Allows clear-text (unencrypted) communication with the LDAP server. Default: disabled
Authentication Port	Port number used for authentication. Default: 389
Base-DN	Distinguished Name of the node that contains the entire user database. Default: N/A
Filter	A string searches for users in the LDAP database. The default filter string is: <b>(objectclass=*)</b> . Default: N/A
Key Attribute	A string searches for a LDAP server. For Active Directory, the value is sAMAccountName.

Parameter	Description
	Default: sAMAccountName
Timeout	Timeout period of a LDAP request, in seconds. Default: 20 seconds
Mode	Enables or disables the server. Default: enabled
Preferred Connection Type	Preferred type of connection between a managed device and the LDAP server. The default order of connection type is: <ul style="list-style-type: none"> <li>1. ldap-s</li> <li>2. start-tls</li> <li>3. clear-text</li> </ul> The managed device first attempts to contact the LDAP server using the preferred connection type, and only attempts to use a lower-priority connection type if the first attempt is not successful.  <b>NOTE:</b> If you select <b>clear-text</b> as the preferred connection type, you must also enable the <b>allow-cleartext</b> option.
Maximum number of non-admin connections	Configure the maximum number of non-admin connections to the server. Default: 4

## Using the WebUI

1. In the **Mobility Master** node hierarchy, navigate to the **Configuration > Authentication > Auth Servers** page.
2. To configure an LDAP server, click **+** under **All Servers**. Set the **Type** to **Ldap**, enter the **Name** for the server, and enter the **IP address**. Click **Apply**.
3. Select the name to configure server parameters. Enter parameters as described in [Table 33](#). Set **Mode** to **Enabled** to activate the authentication server.
4. Click **Submit**.
5. Click **Pending Changes**.
6. In the **Pending Changes** window, select the check box and click **Deploy changes**.




---

The configuration does not take effect until you perform this step.

---

## Using the CLI

```
(host) [mynode] (config) #aaa authentication-server ldap <name>
host <ipaddr>

(enter parameters as described in Table 33)
enable
```

## Configuring a TACACS+ Server

[Table 34](#) defines the TACACS+ server parameters.

**Table 34: TACACS+ Server Configuration Parameters**

Parameter	Description
Host	IP address of the server. Default: N/A
Key	Shared secret to authenticate communication between the TACACS+ client and server. Default: N/A
TCP Port	TCP port used by server. Default: 49
Retransmits	Maximum number of times a request is retried. Default: 3
Timeout	Timeout period for TACACS+ requests, in seconds. Default: 20 seconds
Mode	Enables or disables the server. Default: enabled
Session Authorization	Enables or disables session authorization. Session authorization turns on the optional authorization session for admin users. Default: disabled

### Using the WebUI

1. In the **Mobility Master** node hierarchy, navigate to the **Configuration > Authentication > Auth Servers** page.
2. To configure a TACACS+ server, click **+** under **All Servers**. Set the **Type** to **Tacacs**, enter the **Name** for the server, and enter the **IP address**. Click **Apply**.
3. Select the name to configure server parameters. Enter parameters as described in [Table 34](#). Set the **Mode** to **Enabled** to activate the authentication server.
4. Click **Submit**.
5. Click **Pending Changes**.
6. In the **Pending Changes** window, select the check box and click **Deploy changes**.




---

The configuration does not take effect until you perform this step.

---

### Using the CLI

The following command configures, enables a TACACS+ server and enables session authorization:

```
(host) [mynode] (config) #aaa authentication-server tacacs <name>
    clone default
    host <ipaddr>
    key <psk>
    enable
```

## Configuring a Windows Server

[Table 35](#) defines parameters for a Windows server used for stateful NTLM authentication.

**Table 35:** *Windows Server Configuration Parameters*

Parameter	Description
Host	IP address of the server. Default: N/A
Mode	Enables or disables the server. Default: enabled
Windows Domain	Name of the Windows Domain assigned to the server.

### Using the WebUI

1. In the **Mobility Master** node hierarchy, navigate to the **Configuration > Authentication > Auth Servers** page.
2. To configure a Windows server, click **+** under **All Servers**. Set the **Type** to **Windows**, enter the **Name** for the server, and enter the **IP address**. Click **Apply**.
3. Select the name of the server to configure its parameters. Enter the parameters as described in [Table 35](#).
4. Set the **Mode** to **Enabled** to activate the authentication server.
5. Click **Submit**.
6. Click **Pending Changes**.
7. In the **Pending Changes** window, select the check box and click **Deploy changes**.




---

The configuration does not take effect until you perform this step.

---

### Using the CLI

```
(host) [mynode] (config) #aaa authentication-server windows <windows-server-name>
    host <ipaddr>
    enable
```

## Managing the Internal Database

You can create entries in the internal database to authenticate clients. The internal database contains a list of clients, along with the password and default role for each client. When you configure the internal database as an authentication server, client information is checked in incoming authentication requests against the internal database.

### Configuring the Internal Database

Mobility Master uses the internal database for authentication by default. You can choose to use the internal database in a managed device by entering the CLI command **aaa authentication-server internal use-local-switch**. If you use the internal database in a managed device, you need to add clients on the managed device.

## Using the CLI

Enter the following command in enable mode:

```
(host) [mynode] #local-userdb add {generate-username|username <name>}{  
generate-password|password <password>}
```

## Managing Internal Database Files

Mobility Master allows you to import and export user information tables to and from the internal database. These files should not be edited once they are exported. Mobility Master only supports the importing of database files that were created during the export process. Note that importing a file into the internal database overwrites and removes all existing entries.

## Exporting and Importing Files in the CLI

Enter the following command in enable mode:

```
(host) [mynode] #local-userdb export <filename>  
(host) [mynode] #local-userdb import <filename>
```

## Configuring Server Groups

You can create *groups* of servers for specific types of authentication – for example, you can specify one or more RADIUS servers to be used for 802.1X authentication. You can configure servers of different types in one group. For example, you can include the internal database as a backup to a RADIUS server.

## Configuring Server Groups

Server names are unique. You can configure the same server in more than one server group. You must configure the server before you can include it in a server group.

## Using the WebUI

1. In the **Mobility Master** node hierarchy, navigate to the **Configuration > Authentication > Auth Servers** page.
2. The **Server Groups** table displays the server group list.
3. Click **+**. Enter the name of the new server group and click **Apply**.
4. Select the new server group.
5. Under **All Servers**, click **+** to add a server to the group.
  - a. To add an existing server, select **Add existing server** and choose a server from the list. Click **Apply**.
  - b. To add a new server, select **Add new server**. Specify a server type from the **Type** drop-down list, and enter a name and IP address for the server. Click **Apply**.
  - c. Repeat the above step(s) to add other servers to the group.
6. Click **Submit**.
7. Click **Pending Changes**.
8. In the **Pending Changes** window, select the check box and click **Deploy changes**.

## Using the CLI

```
(host) [mynode] (config) #aaa server-group <name>  
auth-server <name>
```

## Configuring Server List Order and Fail-Through

The servers in a server group are part of an ordered list. The first server in the list is always used by default, unless it is unavailable, in which case the next server in the list is used. You can configure the order of servers in the server group through the WebUI using the **up** or **down** arrows (the top server is the first server in the list). In the CLI, the **position** parameter specifies the relative order of servers in the list (the lowest value denotes the first server in the list).

As mentioned previously, the first available server in the list is used for authentication. If the server responds with an authentication failure, there is no further processing for the user or client for which the authentication request failed. You can also enable *fail-through* authentication for the server group so that if the first server in the list returns an authentication deny, the managed device attempts authentication with the next server in the ordered list. The managed device attempts to authenticate with each server in the list until there is a successful authentication or the list of servers in the group is exhausted. This feature is useful in environments where there are multiple, independent authentication servers; users may fail authentication on one server but can be authenticated on another server.

Before enabling fail-through authentication, note the following:

- This feature is not supported for 802.1X authentication with a server group that consists of external EAP-compliant RADIUS servers. You can, however, use fail-through authentication when the 802.1X authentication is terminated on a managed device (AAA FastConnect).
- Enabling this feature for a large server group list may cause excess processing load on the managed device. It is recommended that you use server selection based on domain matching whenever possible (see [Configuring Dynamic Server Selection on page 193](#)).
- Certain servers, such as the RSA RADIUS server, lock out the managed device if there are multiple authentication failures. Therefore, you should not enable fail-through authentication with these servers.

In the following example, you create a server group "corp-serv" with two LDAP servers (ldap-1 and ldap-2), each containing a subset of the usernames and passwords used in the network. When you enable fail-through authentication, users that fail authentication with the first server on the list will be authenticated with the second server.

### Using the WebUI

1. In the **Mobility Master** node hierarchy, navigate to the **Configuration > Authentication > Auth Servers** page.
2. The **All Servers** table displays the LDAP server list.
3. Click **+**. Enter **ldap-1** for the server name, enter the IP address for the server, and select **Ldap** from the **Type** drop-down list. Click **Apply**.
4. Click **+**. Enter **ldap-2** for the server name, enter the IP address for the server, and select **Ldap** from the **Type** drop-down list. Click **Apply**.
5. Under **All Servers**, select **ldap-1** to configure server parameters. Set the **Mode** to **Enabled** to activate the authentication server.
6. Click **Submit**.
7. Repeat [step 5 on page 192](#) to configure **ldap-2**.
8. Click **+** under the **Server Groups** table to add a new server group. Set the server group name to **corp-serv**, and then click **Apply**.
9. Select **corp-serv** from the **Server Groups** table to configure the server group settings.
10. Navigate to the **Options** tab.
11. Set **Fail through** to **Enabled**.
12. Click **Submit**.



13. Navigate to the **Servers** tab.
14. Click **+** to add a server to the group.
  - a. Select **ldap-1**, and then click **Apply**.
  - b. Repeat the step above to add **ldap-2** to the server group.
15. Click **Submit**.
16. Click **Pending Changes**.
17. In the **Pending Changes** window, select the check box and click **Deploy changes**.

## Using the CLI

```
(host) [mynode] (config) #aaa authentication-server ldap ldap-1
    host 10.1.1.234
(host) [mynode] (config) #aaa authentication-server ldap ldap-2
    host 10.2.2.234
(host) [mynode] (config) #aaa server-group corp-serv
    auth-server ldap-1 position 1
    auth-server ldap-2 position 2
    allow-fail-through
```

## Configuring Dynamic Server Selection

Managed devices can dynamically select an authentication server from a server group based on the user information sent by the client in an authentication request. For example, an authentication request can include client or user information in one of the following formats:

- **<domain>\<user>** : for example, corpnet.com\darwin
- **<user>@<domain>** : for example, darwin@corpnet.com
- **host/<pc-name>.<domain>** : for example, host/darwin-g.finance.corpnet.com (this format is used with 802.1X machine authentication in Windows environments)

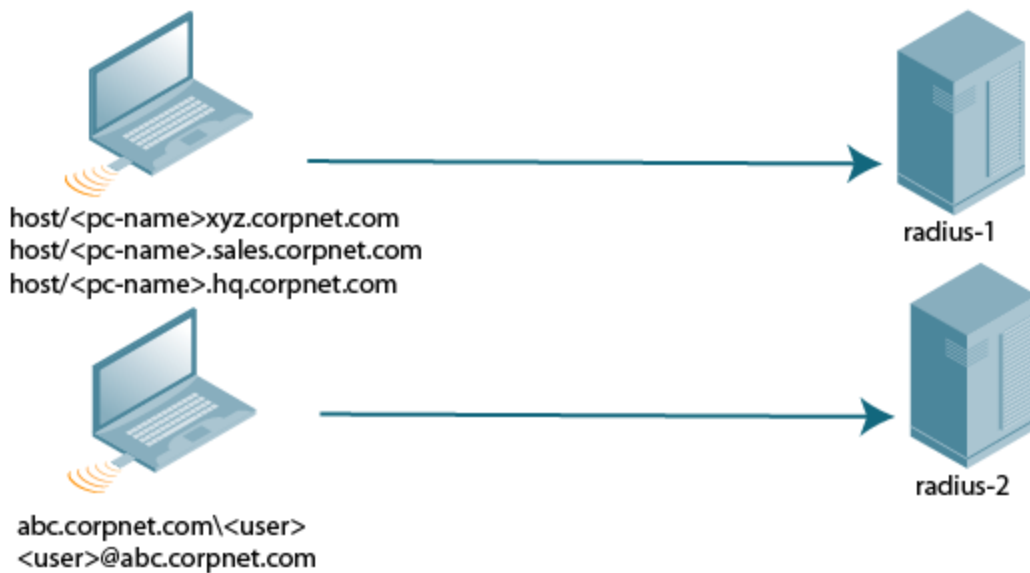
When you configure a server in a server group, you have the option to associate the server with one or more match rules. A match rule for a server can be one of the following:

- The server is selected if the client/user information *contains* a specified string.
- The server is selected if the client/user information *begins* with a specified string.
- The server is selected if the client/user information *exactly* matches a specified string.

You can configure multiple match rules for the same server. Managed devices compare the client/user information with the match rules configured for each server, starting with the first server in the server group. If a match is found, the managed device sends the authentication request to the server with the matching rule. If no match is found before the end of the server list is reached, an error is returned, and no authentication request for the client/user is sent.

[Figure 24](#) depicts a network consisting of several subdomains in corpnet.com. The server radius-1 provides 802.1X machine authentication to PC clients in xyz.corpnet.com, sales.corpnet.com, and hq.corpnet.com. The server radius-2 provides authentication for users in abc.corpnet.com.

**Figure 24** Domain-Based Server Selection Example



### Using the WebUI

1. In the **Mobility Master** node hierarchy, navigate to the **Configuration > Authentication > Auth Servers** page.
2. Under the **Server Groups** table, select a server group.
3. Under the **Server Group > [server group name] > Server Rules** tab, click **+**.
  - a. Select an attribute from the **Attribute** drop-down list.
  - b. Select an **Operation** to apply a condition to the attribute.
  - c. Set the **Operand** value to the client or user information.
  - d. Click **Apply**.
4. Click **Submit**.
5. Click **Pending Changes**.
6. In the **Pending Changes** window, select the check box and click **Deploy Changes**.

### Using the CLI

```
(host) [mynode] (config) #aaa server-group <group>  
  auth-server <name> [match-authstring contains|equals|starts-with <string>] [match-fqdn  
  <string>] [position <number>] [trim-fqdn]
```

### Configuring Match FQDN Option

You can also use the “match FQDN (domain name)” option for a server rule. With this rule, the server is selected if the <domain> portion of the user information in the formats **<domain>\<user>** or **<user>@<domain>** matches a specified string *exactly*. Note the following caveats when using a match FQDN rule:

- This rule does *not* support client information in the host/<pc-name>.<domain> format, so it is not useful for 802.1X machine authentication.
- The match FQDN option performs matches on only the <domain> portion of the user information sent in an authentication request. The match-authstring option (described previously) allows you to match all or a portion of the user information sent in an authentication request.

## Using the WebUI

1. In the **Mobility Master** node hierarchy, navigate to the **Configuration > Authentication > Auth Servers** page.
2. Under the **Server Groups** table, select a server group.
3. Under the **Server Group > [server group name] > Server Rules** tab, click +.
  - a. Select **Domain-Name** from the **Attribute** drop-down list.
  - b. Set the **Operation** to **equals**.
  - c. Set the **Operand** value to the client or user information.
  - d. Click **Apply**.
4. Click **Submit**.
5. Click **Pending Changes**.
6. In the **Pending Changes** window, select the check box and click **Deploy Changes**.

## Using the CLI

```
(host) [mynode] (config) #aaa server-group <group>
auth-server <name> match-fqdn <string>
```

## Trimming Domain Information from Requests

Before a managed device forwards an authentication request to a specified server, it can truncate the domain-specific portion of the user information. This is useful when user entries on the authenticating server do not include domain information. You can specify this option with any server match rule. This option is only applicable when the user information is sent to the managed device in the following formats:

- **<domain>\<user>** : the <domain>\ portion is truncated
- **<user>@<domain>** : the @<domain> portion is truncated



---

This option does not support client information sent in the format `host/<pc-name>.<domain>`

---

## Using the WebUI

1. In the **Mobility Master** node hierarchy, navigate to the **Configuration > Authentication > Auth Servers** page.
2. Under the **Server Groups** table, select a server group.
3. Under **Server Group > [server group name] > Servers**, select a server or click + to add a new server to the group.
  - a. To add an existing server, select **Add existing server** and choose a server from the list. Click **Apply**.
  - b. To add a new server, select **Add new server**. Specify a server type from the **Type** drop-down list, and enter a name and IP address for the server. Click **Apply**.
4. Click **Server Group Trim FQDN**.
5. Set **Trim FQDN** to **Enabled**.
6. Click **Submit**.
7. Click **Pending Changes**.
8. In the **Pending Changes** window, select the check box and click **Deploy Changes**.

## Using the CLI

```
(host) [mynode] (config) #aaa server-group <group>
auth-server <name> trim-fqdn
```

## Configuring Server-Derivation Rules

When you configure a server group, you can set the VLAN or role for clients based on attributes returned for the client by the server during authentication. The server derivation rules apply to all servers in the group. The user role or VLAN assigned through server derivation rules takes precedence over the default role and VLAN configured for the authentication method.



The authentication servers must be configured to return the attributes for the clients during authentication. For instructions on configuring the authentication attributes in a Windows environment using IAS, refer to the documentation at <http://technet2.microsoft.com/windowsserver/en/technologies/ias.mspx>

The server rules are applied based on the first match principle. The first rule that is applicable for the server and the attribute returned is applied to the client, and would be the only rule applied from the server rules. These rules are applied uniformly across all servers in the server group.

[Table 36](#) describes the server rule parameters you can configure.

**Table 36:** *Server Rule Configuration Parameters*

Parameter	Description
Attribute	This is the attribute returned by the authentication server that is examined for <i>Operation</i> and <i>Operand</i> match.
Operation	This is the match method by which the string in <i>Operand</i> is matched with the attribute value returned by the authentication server. <ul style="list-style-type: none"><li>contains : The rule is applied if and only if the attribute value contains the string in parameter <i>Operand</i>.</li><li>starts-with : The rule is applied if and only if the attribute value returned starts with the string in parameter <i>Operand</i>.</li><li>ends-with : The rule is applied if and only if the attribute value returned ends with the string in parameter <i>Operand</i>.</li><li>equals : The rule is applied if and only if the attribute value returned equals the string in parameter <i>Operand</i>.</li><li>not-equals : The rule is applied if and only if the attribute value returned is not equal to the string in parameter <i>Operand</i>.</li><li>value-of : This is a special condition. What this implies is that the role or VLAN is set to the value of the attribute returned. For this to be successful, the role and the VLAN ID returned as the value of the attribute selected must already be configured on the managed device when the rule is applied.</li></ul>
Operand	This is the string to which the value of the returned attribute is matched.
Action	Defines whether to assign a role or a VLAN to the user when the rule is matched.
Role or VLAN	The server derivation rules apply to either user role or VLAN assignment. With Role assignment, a client can be assigned a specific role based on the attributes returned. In VLAN assignment, the client can be placed in a specific VLAN based on the attributes returned.

## Using the WebUI

1. In the **Mobility Master** node hierarchy, navigate to the **Configuration > Authentication > Auth Servers** page.
2. Under the **Server Groups** table, select a server group.
3. Under **Server Group > [server group name] > Servers**, select a server or click + to add a new server to the group.
  - a. To add an existing server, select **Add existing server** and choose a server from the list. Click **Apply**.
  - b. To add a new server, select **Add new server**. Specify a server type from the **Type** drop-down list, and enter a name and IP address for the server. Click **Apply**.
4. Under the **Server Rules** tab, click + to add server derivation rules for assigning a user role or VLAN.
  - a. Select the **Attribute**.
  - b. Select the **Operation** from the drop-down list.
  - c. Enter the **Operand**.
  - d. To set a role, select **set role** from the **Action** drop-down list. Select the role to be assigned from the **Role** drop-down list.
  - e. To set a vlan, select **set vlan** from the **Action** drop-down list. Select the VLAN name or ID from the **Vlan** drop-down list.
  - f. Click **Apply**.
  - g. Repeat the above steps to add other rules for the server group.
5. Click **Submit**.
6. Click **Pending Changes**.
7. In the **Pending Changes** window, select the check box and click **Deploy Changes**.

## Using the CLI

```
(host) [mynode] (config) #aaa server-group <name>
(host) [mynode] (Server Group name) #set {role|vlan} condition <attribute> contains|ends-
with|equals|not-equals|starts-with <operand> set-value <set-value-str> position <number>
```

## Configuring a Role Derivation Rule for the Internal Database

When you add a user entry to the internal database, you can specify a user role (see [Managing the Internal Database on page 190](#)). The role specified in the internal database entry to be assigned to the authenticated client, you must configure a server derivation rule as shown in the following:

## Using the CLI

```
(host) [mynode] (config) #aaa server-group internal
    set role condition Role value-of
```

## Assigning Server Groups

You can create server groups for the following purposes:

- user authentication
- management authentication
- accounting

You can configure all types of servers for user and management authentication (see [Table 37](#)). Accounting is only supported with RADIUS and TACACS+ servers when RADIUS or TACACS+ is used for authentication.

**Table 37: Server Types and Purposes**

	RADIUS	TACACS+	LDAP	Internal Database
User authentication	Yes	Yes	Yes	Yes
Management authentication	Yes	Yes	Yes	Yes
Accounting	Yes	Yes	No	No

## User Authentication

For information about assigning a server group for user authentication, refer to the *Roles and Policies* chapter of the *ArubaOS User Guide*.

## Management Authentication

Users who need to access Mobility Master to monitor, manage, or configure the Aruba user-centric network can be authenticated with RADIUS, TACACS+, or LDAP servers or the internal database.



---

Only user record attributes are returned upon successful authentication. Therefore, to derive a management role other than the default mgmt auth role, set the server derivation rule based on the user attributes.

---

## Using the CLI

```
(host) [mynode] (config) #aaa authentication mgmt
  server-group <group>
  enable
```

## Accounting

You can configure accounting for RADIUS and TACACS+ server groups.



---

RADIUS or TACACS+ accounting is only supported when RADIUS or TACACS+ is used for authentication.

---

## RADIUS Accounting

RADIUS accounting allows user activity and statistics to be reported from managed devices to RADIUS servers:

1. The managed device generates an Accounting Start packet when a user logs in. The code field of transmitted RADIUS packet is set to 4 (Accounting-Request). Note that sensitive information, such as user passwords, are not sent to the accounting server. The RADIUS server sends an acknowledgement of the packet.
2. The managed device sends an Accounting Stop packet when a user logs off; the packet information includes various statistics such as elapsed time, input and output bytes, and packets. The RADIUS server sends an acknowledgment of the packet.

The following attributes can be sent to a RADIUS accounting server:

- **Acct-Status-Type:** This attribute marks the beginning or end of accounting record for a user. Current values are Start, Stop, and Interim Update.
- **User-Name:** Name of user.
- **Acct-Session-Id:** A unique identifier to facilitate matching of accounting records for a user. It is derived from the user name, IP address, and MAC address. This is set in all accounting packets.

- **Acct-Authentic:** This indicates how the user was authenticated. Current values are 1 (RADIUS), 2 (Local), and 3 (LDAP).
- **Acct-Session-Time:** The elapsed time, in seconds, that the client was logged in to the managed device. This is only sent in Accounting-Request records, where the Acct-Status-Type is Stop or Interim Update.
- **Acct-Terminate-Cause:** Indicates how the session was terminated and is sent in Accounting-Request records where the Acct-Status-Type is Stop. Possible values are:
  - 1: User logged off
  - 4: Idle Timeout
  - 5: Session Timeout. Maximum session length timer expired.
  - 7: Admin Reboot: Administrator is ending service, for example prior to rebooting the Mobility Master.
- **NAS-Identifier:** This is set in the RADIUS server configuration.
- **NAS-IP-Address:** IP address of the managed device. You can configure a “global” NAS IP address:
  - In the **Mobility Master** node hierarchy of the WebUI, navigate to the **Configuration > Authentication > Advanced** page. Under **RADIUS Client**, enter the IPv4 or IPv6 address.
  - In the CLI, use the, **ip radius nas-ip** command.
- **NAS-Port:** Physical or virtual port (tunnel) number through which the user traffic is entering the managed device.
- **NAS-Port-Type:** Type of port used in the connection. This is set to one of the following:
  - 5: admin login
  - 15: wired user type
  - 19: wireless user
- **Framed-IP-Address:** IP address of the user.
- **Calling-Station-ID:** MAC address of the user.
- **Called-station-ID:** MAC address of the managed device.

The following attributes are sent in Accounting-Request packets when Acct-Status-Type value is Start:

- Acct-Status-Type
- User-Name
- NAS-IP-Address
- NAS-Port
- NAS-Port-Type
- NAS-Identifier
- Framed-IP-Address
- Calling-Station-ID
- Called-station-ID
- Acct-Session-ID
- Acct-Authentic

The following attributes are sent in Accounting-Request packets when Acct-Status-Type value is Stop:

- Acct-Status-Type
- User-Name
- NAS-IP-Address
- NAS-Port
- NAS-Port-Type
- NAS-Identifier

- Framed-IP-Address
- Calling-Station-ID
- Called-station-ID
- Acct-Session-ID
- Acct-Authentic
- Terminate-Cause
- Acct-Session-Time

The following attributes are sent only in Accounting Stop packets (they are not sent in Accounting Start packets):

- Acct-Input-Octets
- Acct-Output-Octets
- Acct-Input-Packets
- Acct-Output-Packets

Remote APs in split-tunnel mode now support RADIUS accounting. If you enable RADIUS accounting in a split-tunnel Remote AP's AAA profile, the managed device sends a RADIUS accounting start record to the RADIUS server when a user associates with the remote AP, and sends a stop record when the user logs out or is deleted from the user database. If interim accounting is enabled, the managed device sends updates at regular intervals. Each interim record includes cumulative user statistics, including received bytes and packets counters.

You can use either the WebUI or CLI to assign a server group for RADIUS accounting.

### Using the WebUI

1. In the **Managed Network** node hierarchy, navigate to the **Configuration > Authentication > AAA Profiles** page.
2. Under **AAA Profiles** select the **AAA** profile instance.
3. (Optional) In the **Profile Details** pane, select **RADIUS Interim Accounting** to allow the managed device to send Interim-Update messages with current user statistics to the server at regular intervals. This option is disabled by default, allowing the managed device to send only *start* and *stop* messages RADIUS accounting server.
4. Select a AAA profile, and then scroll down to select the **Radius Accounting Server Group** for the AAA profile. Select the server group from the drop-down list.

You can add additional servers to the group or configure server rules.

5. Click **Save**.
6. Click **Pending Changes**.
7. In the **Pending Changes** window, select the check box and click **Deploy Changes**.

### Using the CLI

```
(host) [mynode] (config) #aaa profile <profile>
    radius-accounting <group>
    radius-interim-accounting
```

## RADIUS Accounting on Multiple Servers

ArubaOS provides support to send RADIUS accounting to multiple RADIUS servers. Mobility Master notifies all the RADIUS servers to track the status of authenticated users. Accounting messages are sent to all the servers configured in the server group in a sequential order.

You can enable multiple server account functionality by using the WebUI and CLI:



## Using the WebUI

1. In the **Managed Network** node hierarchy, navigate to the **Configuration > Authentication > AAA Profiles** page.
2. Under **AAA Profiles** select the AAA profile instance.
3. Select the **Multiple Server Accounting** check box.
4. Click **Save**.
5. Click **Pending Changes**.
6. In the **Pending Changes** window, select the check box and click **Deploy Changes**.

## Using the CLI

To enable RADIUS Accounting on Multiple Servers functionality, use the following CLI:

```
(host) [mynode] (config) # aaa profile <profile_name>
    multiple-server-accounting
```

## TACACS+ Accounting

TACACS+ accounting allows commands issued on a Mobility Master or managed device to be reported to TACACS+ servers. You can specify which types of commands are reported (action, configuration, or show commands), or report all commands.

You can only configure TACACS+ accounting through the CLI:

```
(host) [mm] (config) #aaa tacacs-accounting
(host) ^[mm] (config-submode) #command {action|all|configuration|show}
(host) ^[mm] (config-submode) #server-group <name of the TACACS server>
(host) ^[mm] (config-submode) #write memory
```

## Configuring Authentication Timers

[Table 38](#) describes the timers you can configure for all clients and servers. These timers can be left at their default values for most implementations.

**Table 38: Authentication Timers**

Timer	Description
User Idle Timeout	<p>Maximum period after which a client is considered idle if there is no wireless traffic from the client. The timeout period is reset if there is wireless traffic. If there is no wireless traffic in the timeout period, the client is aged out. Once the timeout period has expired, the user is removed. If the keyword <b>seconds</b> is not specified, the value defaults to minutes at the command line.</p> <p>Range: 1–255 minutes (30–15300 seconds) Default: 5 minutes (300 seconds)</p>
Authentication Server Dead Time	<p>Maximum period, in minutes, that the managed device considers an unresponsive authentication server to be “out of service.”</p> <p>This timer is only applicable if there are two or more authentication servers configured on a managed device. If there is only one authentication server configured, the server is never considered out of service, and all requests are sent to the server.</p> <p>If one or more backup servers are configured and a server is unresponsive, it is marked as out of service for the dead time; subsequent requests are sent to the next server on the priority list for the duration of the dead time. If the server is responsive after the dead time has elapsed, it can take over servicing requests from a lower-priority server; if the server continues to be unresponsive, it is marked as down for the dead time.</p> <p>Range: 0–50 minutes Default: 10 minutes</p>
Logon User Lifetime	<p>Maximum time, in minutes, unauthenticated clients are allowed to remain logged on.</p> <p>Range: 0–255 minutes Default: 5 minutes</p>
User Interim stats frequency	<p>Sets the timeout value for user stats, reporting in minutes or seconds.</p> <p>Range: 300–600 seconds, or 5–10 minutes Default: 600 seconds</p>

## Setting an Authentication Timer

To set an authentication timer, complete one of the following procedures:

### Using the WebUI

1. In the **Mobility Master** node hierarchy, navigate to the **Configuration > Authentication > Advanced** page.
2. Configure the timers as described above.
3. Click **Submit**.
4. Click **Pending Changes**.
5. In the **Pending Changes** window, select the check box and click **Deploy Changes**.

## Using the CLI

The commands below configure timers you can apply to clients. If the optional seconds keyword is not specified for the **idle-timeout** and **stats-timeout** parameters, the value defaults to minutes.

```
(host) [mynode] (config) #aaa timers
  dead-time <minutes>
  idle-timeout <time> [seconds]
  logon-lifetime <0-255>
  stats-timeout <time> [seconds]
```

## Authentication Server Load Balancing

Load balancing of authentication servers ensures that the authentication load is split across multiple authentication servers, thus avoiding any one particular authentication server from being overloaded. Authentication Server Load Balancing functionality enables Mobility Master to perform load balancing of authentication requests destined for external authentication servers (Radius/LDAP etc). This prevents any one authentication server from having to handle the full load during heavy authentication periods, such as at the start of the business day.

Previously, the controller used the first authentication server in the server group list. The remaining servers in that group would be used in sequential order only when an authentication server was down. Thus, the controllers performed fail-over instead of load balancing of authentication servers.

The load balancing algorithm computes the expected time taken to authenticate a new client for each authentication server and chooses that authentication server with the shortest expected authentication time. The load balancing algorithm maintains re-authentication stickiness, meaning that at the time of re-authentication, the request is forwarded to the same server where it was originally authenticated.

### Enabling Authentication Server Load Balancing Functionality

Use the **aaa server-group** command to enable authentication server load balancing functionality.

```
(host) [mynode] (config) #aaa server-group <group>
  load-balance
  auth-server s1
  auth-server s2
```

You can use the following command to disable load balancing:

```
(host) [mynode] (config) #aaa server-group <group>
  no load-balance
```



---

If you configure an internal server in the server group, load balancing is not applicable to the internal server. The internal server will be used as a fall-back when all other servers in the group are down.

---

This chapter describes how to configure MAC-based authentication on the Mobility Master using the WebUI or the CLI.

Use MAC-based authentication to authenticate devices based on their physical Media Access Control (MAC) address. Although this not the most secure and scalable method, MAC-based authentication implicitly provides an additional layer of security to authenticate devices. MAC-based authentication is often used to authenticate and allow network access through certain devices while denying access to the rest. For example, if clients are allowed access to the network through station A, then one method of authenticating station A is MAC-based. Clients may be required to authenticate themselves using other methods depending on the network privileges required.

MAC-based authentication can also be used to authenticate Wi-Fi phones as an additional layer of security to prevent other devices from accessing the voice network using what is normally an insecure SSID.

This chapter describes the following topics:

- [Configuring MAC-Based Authentication on page 204](#)
- [Configuring Clients on page 206](#)

## Configuring MAC-Based Authentication

Before configuring MAC-based authentication, you must configure the following options:

- **User role**—The user role that will be assigned as the default role for the MAC-based authenticated clients. (See [Roles and Policies on page 367](#) for information on firewall policies to configure roles.)  
Configure the default user role for MAC-based authentication in the AAA profile. If derivation rules exist or if the client configuration in the internal database has a role assigned, these values take precedence over the default user role.
- **Authentication server group**—The authentication server group that the managed device uses to validate the clients. The internal database can be used to configure the clients for MAC-based authentication. See [Configuring Clients on page 206](#) for information on configuring the clients on the local database. For information on configuring authentication servers and server groups, see [Authentication Servers on page 180](#).

### Configuring the MAC Authentication Profile

You can configure MAC-based authentication on the Mobility Master using the WebUI or the CLI.

#### In the WebUI

To configure MAC-based authentication, perform the following steps:

1. In the **Mobility Master** node hierarchy, select a managed device.
2. Navigate to **Configuration > Authentication > L2 Authentication**.
3. Click **MAC Authentication** under L2 Authentication section.
4. In the **MAC Authentication Profile: New Profile** section, click the + icon.
5. Enter a profile name in the **Profile name** text box.
6. Configure the parameters, as described in [Table 39](#).
7. Click **Save** at the bottom of the page.

8. Click **Pending Changes** at the top of the page.
9. In the **Pending Changes** window, select the check box indicating the pending change and click **Deploy Changes**.

[Table 39](#) describes the parameters you can configure for MAC-based authentication.

**Table 39: MAC Authentication Profile Configuration Parameters**

Parameter	Description
Profile name	Name of the MAC authentication profile.
Delimiter	Delimiter used in the MAC string: <ul style="list-style-type: none"> <li>• colon specifies the format XX:XX:XX:XX:XX:XX</li> <li>• dash specifies the format XX-XX-XX-XX-XX-XX</li> <li>• none specifies the format XXXXXXXXXXXXX</li> <li>• oui-nic specifies the format XXXXXX-XXXXXX</li> </ul> Default: none
Case	The case (upper or lower) used in the MAC string. Default: lower
Max Authentication failures	Number of times a station can fail to authenticate before it is blacklisted. A value of zero disables blacklisting. Default: zero (0)
Reauthentication	Select the <b>Reauthentication</b> check box if you want to enable Reauthentication; Default: disable.
Reauthentication Interval	Time duration between reauthentication attempts. Configure a value in the range of 60–86,400. Reauthentication timer is configured in terms of seconds.
Use Server provided Reauthentication Interval	Select the <b>Use Server provided Reauthentication Interval</b> check box to use the interval provided by the server; Default: disable.

### In the CLI

Execute the following command from the Mobility Master node (although this is not the most secure and scalable method) to configure a MAC authentication profile:

```
(host) [mynode] (config) #aaa authentication mac <profile>
(host) [mynode] (MAC Authentication Profile "profile") #case {lower|upper}
(host) [mynode] (MAC Authentication Profile "profile") #clone {default|<source>}
(host) [mynode] (MAC Authentication Profile "profile") #delimiter {colon|dash|none|oui-nic}
(host) [mynode] (MAC Authentication Profile "profile") #max-authentication-failures <max-authentication-failures-number>
(host) [mynode] (MAC Authentication Profile "profile") #reauthentication
(host) [mynode] (MAC Authentication Profile "profile") #timer reauth-period <reauth period>
```

## Configuring Clients

You can create entries in the Mobility Master's internal database to authenticate client MAC addresses. The internal database contains a list of clients along with the password and default role for each client. To configure entries in the internal database for MAC authentication, enter the the username and password for each client.

### In the WebUI

Perform the following steps to configure the clients:

1. In the **Mobility Master** node, navigate to **Configuration > Authentication > Auth Servers**.
2. In the **All Servers** section, click **Internal**. The **Server > Internal** section is displayed below the **All Servers** section.
3. In the **Server > Internal > Users** section, click the + icon.
4. In the **Internal Server > Add New User** section, for automatic username and password generation, click **Generate** beside the corresponding text boxes. Otherwise, enter the username and password in the text boxes.
5. Select the role from the **Role** drop-down list.
6. Select **Enabled** from the drop-down list to activate the user entry on creation.
7. Select the expiration duration mode from the **Expiration** drop-down list. Expiration represents the maximum time duration that a guest account is valid for.
  - a. If you selected duration, set the time for expiration in minutes.
  - b. If you selected time, set the date (mm/dd/yyyy format) and time (hh:mm format) in the **Date** and **Time** boxes.
8. Click **Submit** at the bottom of the page.
9. Click **Pending Changes** at the top of the page.
10. In the **Pending Changes** window, select the check box indicating the pending change and click **Deploy Changes**.

### In the CLI

Execute the following command from the Mobility Master node:

```
(host)[mynode] #local-userdb add generate-username generate-password role <user-role> mode {disable} expiry {duration <1+> | time <mm/dd/yyyy> <hh:mm>}
```

Many distributed enterprises with branch and remote offices and locations use cost-effective hybrid WAN connectivity solutions that include low-cost DSL, 4G and LTE technologies, rather than relying solely on traditional E1/T1 or T3/E3 dedicated circuits. 7000 Series Cloud Services Controllers are optimized for these types of locations, which are more likely to use cloud security architectures instead of dedicated security appliances, and where clients are likely to access applications in the cloud, rather than on local application servers.

## Provision and Configure Managed Devices

This chapter describes ArubaOS features designed to optimize the configuration and performance of managed devices in branch and remote offices, and lists the procedures to configure these features

### Learn more about Managed Device Optimization

Select any of the links below to view detailed information about ArubaOS features for managed device configuration and management, and examples of deployment topologies that support these features.

- [Managed Device Feature Overview](#)
- [Zero-Touch Provisioning Overview](#)
- [WAN Authentication Survivability Overview](#)

### Provision and Configure a Managed Device

The following sections describe the procedures to configure your network for zero-touch managed device provisioning, and to define configuration settings for a group of managed devices.

- [Using ZTP to Provision a Managed Device on page 216](#)
- [Health Check Services for Managed Devices on page 220](#)
- [WAN Optimization through IP Payload Compression on page 221](#)
- [WAN Interface Bandwidth Priorities on page 222](#)
- [Uplink Monitoring and Load Balancing on page 223](#)
- [Policy Based Routing on page 226](#)
- [Uplink Routing using Nexthop Lists on page 227](#)
- [Address Pool Management on page 229](#)
- [Configuring WAN Authentication Survivability on page 232](#)
- [Preventing WAN Link Failure on Virtual APs](#)

## Managed Device Feature Overview

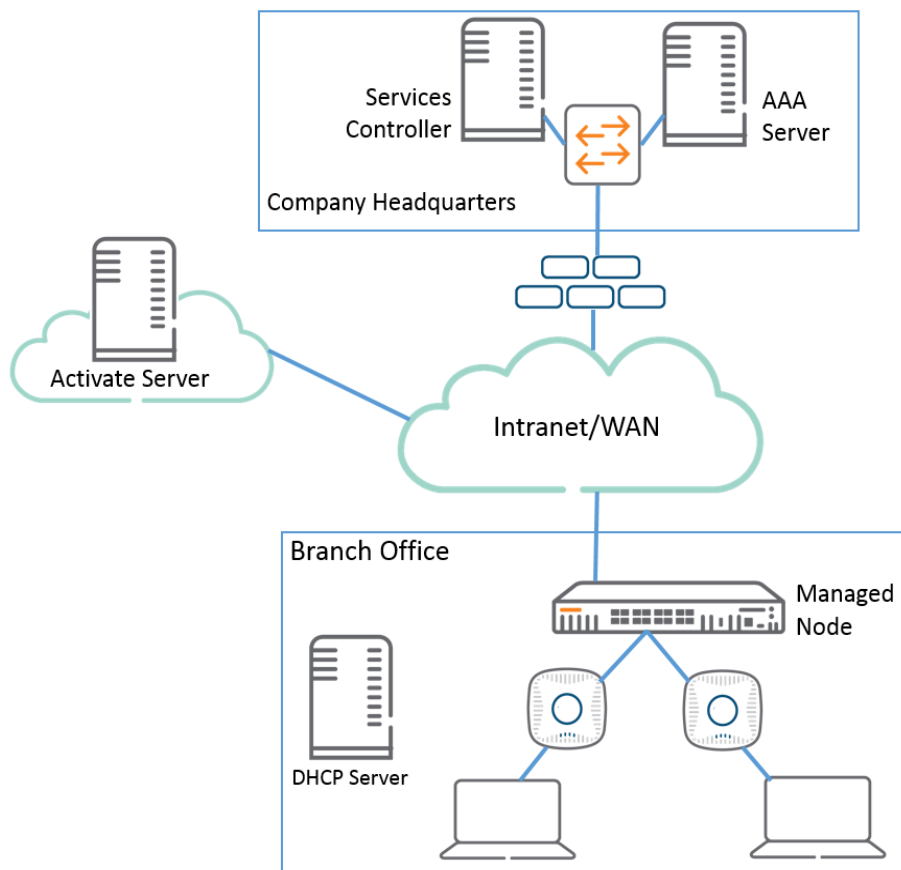
ArubaOS supports these distributed enterprises through the following features designed specifically for managed devices in branch and remote offices:

- Authentication survivability allows managed devices to store user access credentials and key reply attributes whenever clients are authenticated with external RADIUS servers or LDAP authentication servers, providing authentication and authorization survivability when remote authentication servers are not accessible.

- Integration with existing Palo Alto Networks Firewalls, like WildFire™ anti-virus and anti-malware detection services. In deployments with multiple Palo Alto Networks (PAN) firewalls, managed devices can select the best PAN firewall based on priority and availability.
- Policy-based routing on each uplink interface, which allows you specify the next hop to which packets are routed. ArubaOS supports multiple next-hop lists, to ensure connectivity in the event that a device on the list becomes unreachable.
- Uplink and VPN redundancy, and per-interface bandwidth contracts to limit traffic for individual applications (or categories of applications) either sent from or received by a selected interface.
- Packet compression between Aruba devices (such as devices at the branch and main office), to maximize the amount of data that can be carried by the network.
- A WAN health-check feature that uses ping-probes to measure WAN availability and latency on each uplink.

The following diagram depicts a managed device topology where a managed device in the branch office learns the address, routing information, and other provisioning information from the Mobility Master.

**Figure 25** *Managed Device Topology*



## Scalable Site-to-Site VPN Tunnels

ArubaOS supports site-to-site IPsec tunnels based on a Fully Qualified Domain Name (FQDN). When you identify the remote peer for a managed device using an FQDN, that node configuration can be applied across multiple branch managed devices, as the configured FQDN can resolve to different IP addresses for each local branch, based on local DNS settings.

Crypto maps for site-to-site VPNs support a VLAN ID as the identifier for the source network. When the VPN settings are pushed to a managed device, the IKE negotiation process uses the IP address range for the VLAN. This feature allows multiple managed devices to use a single group of configuration settings defined at a



configuration node, as each managed device negotiates a different source source network IP for its VLAN, based on the IP pool for the managed devices defined for that configuration node.

## WAN Health Check

The health-check feature uses ping-probes to measure WAN availability and latency on selected uplinks. Based upon the results of this health-check information, the managed device can continue to use its primary uplink, or failover to a backup link. Latency is calculated based on the round-trip time (RTT) of ping responses. The results of this health check appear in the **WAN** section of the [Monitoring Dashboard](#).

## Zero-Touch Provisioning Overview

Traditionally, the deployment of controllers was a multiple step process where the master controller information and local configurations were first pre-provisioned. After the managed device connected to the network, it established a secure tunnel to the master and downloaded the global configuration. Zero touch provisioning automates deployment of managed devices plug-n-play. The managed device now learns the required information from the network and provisions itself automatically. ArubaOS allows a managed device to automatically get its local and global configuration and license limits from Mobility Master.

This section includes the following topics:

- [Why use ZTP? on page 209](#)
- [Managed Device Provisioning Modes on page 210](#)
- [Managed Device Address Pools on page 210](#)
- [Zero-Touch Provisioning Workflows on page 211](#)



---

For more information about the procedures to prepare your network for ZTP, see [Using ZTP to Provision a Managed Device on page 216](#).

---

### Why use ZTP?

ZTP offers the following advantages over a standard managed device configuration:

- simple deployment
- reduced operational cost
- limits to provisioning errors

A managed device configured using ZTP automatically discovers the Mobility Master, downloads its local configuration from that Mobility Master, and is provisioned with its device role, and country code.



---

The local configuration is the configuration that is specific to a managed device. That is, not the global configuration shared by a network of managed devices. This includes, but is not limited to, IP addresses and VLANs.

---

Once the managed node is provisioned, it is ready to obtain its global configuration in either of two ways:

- The administrator enters the global configuration via the WebUI or CLI of the Mobility Master.
- The managed device retrieves its global configuration from the Mobility Master.

Device-specific configurations that are common across multiple devices can be modified from a central location using the bulk edit feature. Users can apply common device configurations to a group of devices without having to update each device individually. Bulk edit supports, but is not limited to, the following configurations:

- Time zone
- Daylight savings time setting
- VLANs
- Managed device IP addresses
- DHCP pools

## Managed Device Provisioning Modes

The administrator has the choice of provisioning modes that select how the managed device is supplied with its own IP address, role, country code, and configuration settings.

Once the managed device learns the IP address of the primary Mobility Master, the managed device contacts that Mobility Master and retrieves its configuration from its assigned configuration node.




---

Before you deploy a managed device, you must create a configuration for that device at a configuration node on Mobility Master. Mobility Master pushes this configuration to the managed device when the device becomes active on the network.

---

ArubaOS supports the following provisioning modes for managed devices:

- **auto:** In this mode, the managed device:
  - obtains its IP address from DHCP
  - obtains its role, country code, and the IP addresses of the Mobility Master and any defined secondary Mobility Master from a provisioning rule in Activate
  - retrieves its configuration from a configuration node on Mobility Master
- **mini-setup:** In this mode, the managed device:
  - has its role set to local (local) when mini-setup is initiated
  - obtains its IP address from DHCP
  - is configured through the console with its country code and the IP address of the primary Mobility Master and (optionally) the secondary Mobility Master IP
  - retrieves its local config group from the primary Mobility Master
- **full-setup:** In this mode, the managed device:
  - is configured with its role set to local (local) through the console
  - is configured to obtain its IP address through manual configuration of a static IP, DHCP, or PPPoE
  - is configured through the console with its country code and the IP address of the primary Mobility Master and (optionally) the secondary Mobility Master IP
  - retrieves its configuration from a configuration node on the primary Mobility Master

## Managed Device Address Pools

Each managed device needs a pool of addresses it can dynamically assign to APs or users on each of its VLANs, and a separate IP address that managed device uses to create a GRE tunnel to Mobility Master. Mobility Master can assign IP these addresses to managed devices using dynamic address pools. These pools allow network administrators to create a generic configuration that provisions managed device interfaces with individual settings that are unique across branch offices. If managed devices are also serving as DHCP servers for other devices at that location, smaller DHCP pools for those individual branches can be dynamically carved out from a larger DHCP pool.

ArubaOS 8.0 supports three different types of address pools that can be applied to a hierarchy node

- **NAT Pools:** A NAT pool is used to assign IP addresses to a VLAN interface on a managed device . The range of addresses in this pool is available for use for any DHCP-enabled managed device when it is added to that specific node in the configuration hierarchy. When you add a managed device, a group of IP addresses is removed from the NAT pool on that hierarchy node and is and leased to the device. The IP addresses in a NAT pool are dynamic (leased) rather than static (permanently assigned), so addresses no longer in use are automatically returned to the pool for reallocation.
- **Tunnel pools:** A tunnel pool defines a range of IP addresses that can be used by the managed devices to create a GRE tunnel to the Mobility Master. When you add a managed device controller, an IP address is removed from the tunnel pool on that hierarchy node and is and leased to that device. Addresses no longer in use are automatically returned to the pool for reallocation.
- **VLAN pools:** A VLAN pool allocates a block of IP addresses for each managed device. The managed device acts as a DNS proxy server and dynamically assigns IP addresses from its allocated pool to each AP or client on the VLAN. A VLAN pool allocates multiple addresses to each managed device VLAN, unlike the tunnel pool, which assigns a single tunnel IP address to each managed device.

## Zero-Touch Provisioning Workflows

The managed device obtains its IP address through DHCP by sending a DHCP discover on the default uplink port. The default uplink port is configured as an access port in VLAN 4094.

Next it will attempt to retrieve the provisioning parameters from Activate. If the managed device is unsuccessful in retrieving the provisioning parameters from Activate, it will retry in 30 seconds. The managed device keeps trying to retrieve the provisioning parameters from Activate every 30 seconds until it is successful or the administrator interrupts Auto-Provisioning by initiating mini-setup or full-setup.

To interrupt the auto provisioning process, enter the string **mini-setup** or **full-setup** at the initial setup dialog prompt shown below.

```
Auto-provisioning is in progress. Choose one of the following options to override or debug...
'enable-debug' : Enable auto-provisioning debug logs
'disable-debug': Disable auto-provisioning debug logs
'mini-setup'   : Stop auto-provisioning and start mini setup dialog for smart-local role
'full-setup'   : Stop auto-provisioning and start full setup dialog for any role
Enter Option (partial string is acceptable):_
```

## WAN Authentication Survivability Overview

Authentication survivability is critical to managed device WLANs since most managed devices use geographically remote authentication servers to provide authentication and authorization services. When those authentication servers are not accessible, clients can't access the WLAN because the managed device can't authenticate them. ArubaOS authentication survivability allows managed devices to provide client authentication and authorization survivability when remote authentication servers are not accessible. When this feature is enabled, ArubaOS stores user access credentials and key reply attributes whenever clients are authenticated with external RADIUS servers or LDAP authentication servers. When external authentication servers are not accessible, the managed device uses its internal survival server to continue providing authentication and authorization functions by using the user access credentials and key reply attributes that were stored earlier.

When authentication survivability is enabled, a internal survival server on the manged node performs authentication functions, as well as EAP-termination using the RADIUS protocol. The survival server performs authentication or query requests when authentication survivability is enabled, *and* one of the following is true:

1. All servers are out of service in the server group if fail-through is disabled
2. All in-service servers failed the authentication and at least one server is out of service when fail-through is enabled.

All access credentials and key reply attributes saved in the local survival server remain in the system until they expire. The system-wide lifetime parameter **auth-survivability cache-lifetime** has a range from 1 to 72 hours, and a default value of 24 hours. Expired user credential attributes and key reply attributes stored in the survival server cache are purged every 10 minutes.



Best practices is to import a customer server certificate into the managed device and assign it to the local survival server.

The survival server can store the following types of client data:

- Client username
- Encrypted Passwords. For Password Authentication Protocol (PAP) authentication, the survival server receives the password provided by the client and then stores the encrypted SHA-1 hashed value of the password.
- EAP indicator: When employing 802.1X with disabled termination using EAP-TLS, the EAP indicator is stored.
- The CN lookup *EXIST* indicator

## Supported Client and Authentication Types

The the following combination of clients and authentication types are supported with the authentication survivability feature (see):

**Table 40:** *Clients and Supported Authentication Types*

Clients	Authentication Methods
Captive Portal clients	Password Authentication Protocol (PAP)
802.1X clients	<ul style="list-style-type: none"> <li>• <i>Termination disabled:</i> Extensible Authentication Protocol-Transport Layer Security (EAP-TLS) with an external RADIUS server</li> <li>• <i>Termination enabled:</i> EAP-TLS with Common Name (CN) lookup with an external authentication server</li> </ul>
External Captive Portal clients using the XML-API	PAP
MAC-based Authentication clients	PAP
VPN clients	<ul style="list-style-type: none"> <li>• PAP with an external authentication server</li> <li>• CN lookup with an external authentication server</li> </ul>
VIA and other VPN clients	PAP method and CN lookup
Wireless Internet Service Provider roaming (WISPr) clients	PAP

## Supported Key Reply Attributes

The following key reply attributes are supported:

- ARUBA\_NAMED\_VLAN
- ARUBA\_NO\_DHCP\_FINGERPRINT

- ARUBA\_ROLE
- ARUBA\_VLAN
- MS\_TUNNEL\_MEDIUM\_TYPE
- MS\_TUNNEL\_PRIVATE\_GROUP\_ID
- MS\_TUNNEL\_TYPE
- PW\_SESSION\_TIMEOUT
- PW\_USER\_NAME

## Feature Restrictions and Limitations

The authentication survivability feature has the following support restrictions:

- The Survival Server cache database is station-based (thus, the MAC address is the key), so authentication survivability is not supported for any station with a zero MAC address.
- For a client using EAP-TLS, you must install the issuer certificate of the Survival Server certificate as a TrustedCA certificate in the client station.
- For an 802.1X client using EAP-TLS that does not terminate at the managed device, the issuer certificate for the client certificate must be imported as a TrustedCA or an intermediateCA certificate at the managed device—just as the same certificate must be installed at the terminating External RADIUS server.
- The Survival Server does not support the Online Certificate Status Protocol (OCSP) nor the Certificate Revocation List (CRL) for EAP-TLS.
- Authentication survivability will not activate if Authentication Server Dead Time is configured as 0.

To configure Authentication Server Dead Time, on the managed device, navigate to: **Configuration > SECURITY > Authentication > Advanced > Authentication Timers > Authentication ServerDeadTime (min)**.

## Captive Portal Authentication Workflow

This section describes the authentication procedures for Captive Portal clients, both when the branch's authentication servers are available and when they are not available. When the authentication servers are not available, the Survival Server takes over the handling of authentication requests.

### Captive Portal Client Authentication Using PAP

[Table 41](#) describes what occurs for Captive Portal clients using PAP as the authentication method.

**Table 41:** *Captive Portal Authentication Using PAP*

When Authentication Servers Are Available	When Authentication Servers Are Not Available
<ul style="list-style-type: none"> <li>• If authentication succeeds, the associated access credential with an encrypted SHA-1 hash of the password and Key Reply attributes are stored in the Survival Server database.</li> <li>• If authentication fails, the associated access credential and Key Reply attributes associated with the PAP method (if they exist) are deleted from the Survival Server database.</li> </ul>	<p>When no in-service server in the associated server group is available, the Survival Server is used to authenticate the Captive portal client using PAP.</p> <p>The Survival Server uses the previously stored unexpired access credential to perform authentication and, upon successful authentication, returns the previously stored Key Reply attributes.</p>

## External Captive Portal Client Authentication Using the XML-API

Table 42 describes the authentication procedures for External Captive Portal clients using the XML-API, both when the branch's authentication servers are available and when they are not available. When the authentication servers are not available, the Survival Server takes over the handling of authentication requests.

**Table 42:** *Captive Portal Authentication Using XML-API*

When Authentication Servers Are Available	When Authentication Servers Are Not Available
<p>For authentication requests from an External Captive Portal using the XML-API, PAP is used to authenticate these requests with an external authentication server.</p> <ul style="list-style-type: none"><li>• If authentication succeeds, the associated access credential with an encrypted SHA-1 hash of the password and Key Reply attributes are stored in the Survival Server database.</li><li>• If authentication fails, the associated access credential and Key Reply attributes associated with the PAP method (if they exist) are deleted from the Survival Server database.</li></ul>	<p>When no in-service server in the associated server group is available, the Survival Server is used to authenticate the Captive portal client using PAP.</p> <p>The Survival Server uses the previously stored unexpired access credential to perform authentication and, upon successful authentication, returns the previously stored Key Reply attributes.</p>

## 802.1X Authentication Workflow

This section describes the authentication procedures for 802.1X clients with termination at an External RADIUS server, or at the controller.

**Table 43:** *802.1X Authentication Terminating at an External Server*

When Authentication Servers Are Available	When Authentication Servers Are Not Available
<p>For an 802.1X client that terminates at an external RADIUS server using EAP-TLS:</p> <ul style="list-style-type: none"><li>• If authentication is accepted, the associated access credential with the <i>EAP-TLS</i> indicator, in addition to the Key Reply attributes, are stored in the Survival Server database.</li><li>• If authentication is rejected, the associated access credential and Key Reply attributes associated with the EAP-TLS method (if they exist) are deleted from the Survival Server database.</li></ul>	<p>When there is no available in-service server in the associated server group, the Survival Server terminates and authenticates 802.1X clients using EAP-TLS.</p> <p>The Survival Server uses the previously stored unexpired access credential to perform authentication and, upon successful authentication, returns the previously stored Key Reply attributes.</p> <p>In this case, the client station must be configured to accept the server certificate assigned to the Survival Server.</p>

For an 802.1X client for which termination is enabled at the managed device using EAP-TLS with Common Name (CN) lookup, a query request about the Common Name is sent to the external authentication server.



---

The external authentication server can be either a RADIUS server or an LDAP server.

---

**Table 44:** 802.1X Client Authentication Using EAP\_TLS with CN Lookup

When Authentication Servers Are Available	When Authentication Servers Are Not Available
<ul style="list-style-type: none"><li>• If the query succeeds, the associated access credential with a returned indicator of <i>EXIST</i>, plus the Key Reply attributes, are stored in the Survival Server database.</li><li>• If the query fails, the associated access credential and Key Reply attributes associated with the Query method (if they exist) are deleted from the Survival Server database.</li></ul>	<p>When there is no available in-service server in the associated server group, the Survival Server performs CN lookup for 802.1X clients for which termination is enabled at the managed device using EAP-TLS.</p> <p>The Survival Server returns previously stored Key Reply attributes as long as the client with the <i>EXIST</i> indicator is in the Survival Server database.</p>

## MAC Authentication Workflow

This section describes the authentication procedures for clients.

**Table 45:** MAC-Based Client Authentication Using PAP

When Authentication Servers Are Available	When Authentication Servers Are Not Available
<ul style="list-style-type: none"><li>• If authentication succeeds, the associated access credential, along with an encrypted SHA-1 hash of the password and Key Reply attributes, are stored in the Survival Server database.</li><li>• If authentication fails, the associated access credential and Key Reply attributes associated with the PAP method (if they exist) are deleted from the Survival Server database.</li></ul>	<p>When there is no available in-service server in the associated server group, the Survival Server authenticates the MAC-based authentication client using PAP.</p> <p>The Survival Server returns previously stored Key Reply attributes as long as the client with the <i>EXIST</i> indicator is in the Survival Server database.</p>

## WISPr Authentication

This section describes the authentication procedures for Wireless Internet Service Provider roaming (WISPr) clients, both when the branch's authentication servers are available and when they are not available. When the authentication servers are not available, the Survival Server takes over the handling of authentication requests.



---

The external authentication server can be either a RADIUS server or an LDAP server.

---

**Table 46:** WISPr Authentication Using PAP

When Authentication Servers Are Available	When Authentication Servers Are Not Available
<p>For a WISPr client authenticated by an external server using PAP:</p> <ul style="list-style-type: none"><li>• If authentication succeeds, the associated access credential, along with an encrypted SHA-1 hash of the password and Key Reply attributes, are stored in the Survival Server database.</li><li>• If authentication fails, the associated access credential and Key Reply attributes (if they exist) associated with the PAP method are deleted from the Survival Server database.</li></ul>	<p>When there is no available in-service server in the associated server group, the Survival Server authenticates the WISPr client using PAP.</p> <p>Upon successful authentication, the Survival Server uses the previously stored unexpired credential to perform authentication, and returns the previously stored Key Reply attributes .</p>

## Using ZTP to Provision a Managed Device

When a factory-default controller boots, it starts the auto-provisioning process. The following sections describe the provisioning workflow, and the process to prepare your network for zero-touch provisioning (ZTP) for a managed device.

When a managed device establishes an HTTPS connection to the Activate server and requests provisioning information, the Activate server authenticates the managed device and provides that device with provisioning information, including the IP address of its Mobility Master and secondary Mobility Master, and its country code. If the managed device is unsuccessful in retrieving the provisioning parameters from Activate, it will retry in 30 seconds. The managed device will keep trying to retrieve the provisioning parameters from Activate until it is successful, or the administrator initiates Mini-Setup or Full-Setup provisioning.

Before you can use Activate to associate a managed device to Mobility Master, you must configure Activate with additional device settings for each managed device and Mobility Master, create a folder for those local devices, then assign a provisioning rule to that folder that associates the managed devices to a specified master and configuration node. Use the following procedures to configure device details for the Mobility Master and managed devices, create folders, and define the provisioning rule.

### Configuring Device details for a Managed Device

When you place an order for a controller, that device appears in the Activate **Devices** list displaying the preconfigured settings for its serial number, MAC address, and software image. Before you can add a managed device to a whitelist, you must use the Activate interface to assign a name to each managed device, and use the Activate interface to identify the Mobility Master in a managed device deployment.

Follow the steps below to use Activate to configure managed device or Mobility Master device settings

1. Click the **Devices** icon at the top of the page to display the **Devices** page.
2. Select a managed device or Mobility Master from the **Devices** list. If the list is very large, you can click the **filter** icon by any **Devices** list column heading and choose which entries to display, then select the managed device from the smaller, filtered list.
3. If the device will be used as the Mobility Master, select the **Master Controller** check box.
4. In the **Device Detail** section of the **Devices** page, enter the following values:
  - **Device name:** (Required) an IP address or fully-qualified domain name for the managed device or Mobility Master
  - **Full name:** (Optional) a user-friendly name for the device
  - **Description:** (Optional) a short text string describing the device



5. Click **Done** to save your settings.

**Figure 26** *Device Details for a Managed Device*

**Device Detail: 00:0B:86:D7:D0:D7**

^ **Device Detail:**

Serial Number: CG00037086  
MAC Eth0: 00:0B:86:D7:D0:D7  
Controller: bc1.lab1.local  
Provisioning Image: 1.0.2.0  
JSON Data: Not-Configured  
Status: provisioned  
First Seen: 12/31/2014 1:16 PM  
Folder: default  
Master Controller:   
Device-Name: bc1.lab1.local  
Full Name:  
Description:

∨ **Order Detail**

Done Cancel

## Creating a New Managed Device Folder

Associate multiple managed devices to the same Mobility Master by moving those managed devices into a single Activate folder.



---

A folder can contain only one model of managed device, using the same country code and mapping to the same configuration node. Different folders need to be created for managed devices of different model types, or that use a different country code or local config group.

---

Follow the steps below to add a new folder to the **Folders** list:

1. Click the **Setup** icon to display the **Setup** page.
2. Click the **New** link in the title bar of the Folders list. The **Create a New Folder** window appears.
3. Enter the following information for the folder:
  - **Name:** Name of the new managed device folder. The folder name must be 100 characters or less, and cannot include the characters **?**, **#** or **&**.
  - **Parent:** The new folder's parent folder. The new folder will be created under the selected parent.
  - **Notes:** (Optional) Use this field to add any additional notes about the folder.
4. Click **Done** to save the new folder.

## Configuring the Provisioning Rule

A folder can only have one provisioning profile configured within it and the provisioning profile can only reference one configuration node. Consequently, it is necessary to create a folder and associate the provisioning rule for each group of managed devices that share a common configuration node.

Follow the steps below to create a new provisioning rule for the new managed device folder

1. Click the **Setup** icon to display the **Setup** page.
2. In the folders section of the **Setup** page, select the new managed device folder.
3. Click the **New** link in the title bar of the **Rules** list. The **Create a New Rule** window appears at the bottom of the page. Enter a value for each required field, then click **Done** to save your settings.

**Figure 27** *New Provisioning Rule*

**Table 47:** *Provisioning Rule Configuration Settings*

Provisioning Rule Setting	Description
Rule Type	Click the <b>Rule Type</b> drop-down list, and select <b>Provisioning Rule</b> .
Parent Folder	Select the folder to which this provisioning rule applies.
Provision Type	Select the <b>Managed Node to Master Controller</b> rule type.
Redundancy Level	Select <b>No Redundancy</b> to configure just a single Mobility Master, choose <b>L2</b> redundancy to define a local backup at the same site as the Mobility Master or select <b>L3</b> to define an additional primary and backup Mobility Master at a different location than the main primary and backup Mobility Master pair.  <b>NOTE:</b> If you select the L3 option, you must configure a , Master Mobility Master and Secondary Mobility Master for Site 1 and Site 2.
Primary Controller	MAC address of the primary Mobility Master. Activate sends a managed device whitelist with information about the managed devices in this folder to the Mobility Master with this MAC address.
Master Controller IP	Enter the IP address used to access Mobility Master or the primary/backup Mobility Master pair.
Secondary Controller	(Optional for Layer-2 or Layer-3 redundancy) MAC address of a backup Mobility Master, for deployments that require layer-2 or Layer-3 redundancy.
VPN Concentrator MAC	The MAC address of the managed device (or other device) that terminates VPN tunnels to the datacenter.

Provisioning Rule Setting	Description
VPN Concentrator IP	The IP address of the managed device (or other device) that terminates VPN tunnels to the datacenter.
Country Code	Select a country code to be assigned to the managed devices in this folder.
Local Config Group	Enter the name of a local config group to assign that group of local configuration settings to the managed devices in this folder.

## Moving a Managed Device to the New Folder

Follow the steps below to assign one or more managed devices to a folder:

1. Click the **Devices** icon at the top of the page to display the **Devices** page.
2. Click the **filter** icon by any Devices list column heading and choose which entries to display. You can repeat this step and filter the list by multiple criteria types until the **Devices** list shows only those devices you want to move to a new folder.
3. Click the **Move to Folder** button at the top of the **Devices** page. A drop-down window appears, displaying with all folder names.
4. Select the destination folder for the devices.
5. A confirmation window appears, showing the total number of devices that will be moved.
6. Click **OK** to confirm the change, or click **Cancel** to cancel the move.

You can also assign an individual device to a new folder by selecting that device from the **Devices** list and manually changing its parent folder in the **Device Details** window.

## Retrieval of a Managed Device Whitelist from Activate

Activate may be configured to supply the list of managed devices to the Mobility Master to be added to the whitelist.

The Mobility Master sends a query to Activate every hour. To initiate an immediate query to Activate, access the Mobility Master CLI in enable mode and issue the command “activate sync.”

When the Mobility Master sends the query to Activate, Activate searches for all provisioning rules of the type **managed node to master controller** that include the MAC address of this Mobility Master in the primary controller field.

## Activate Interface Communication

The managed device and the Mobility Master interact with the Activate server to receive information about each other. Once the Activate server is properly configured with the appropriate folders and provisioning rules, Activate automatically manages the relationship between Mobility Master and all the managed devices associated with that master.

The Mobility Master regularly contacts the Activate server to get a list of its associated managed devices. Managed devices interact with the Activate server to learn about their role, Mobility Master information, and their regulatory domain. The Mobility Master sends its own information and not managed device information. Activate reuses information in the AP-information field for controller interactions between Mobility Master and managed devices.

The following steps describe the how Mobility Master retrieves the whitelist database from the Activate server.

1. The Mobility Master sends an initial post with a keepalive connection type that includes the following information:
  - type = Provision update
  - mode = controller
  - a session ID
  - AP information that includes <serial number>, <mac-address>, <model>
2. Activate responds with the following information:
  - type = provision update
  - an Activate-assigned session ID
  - status
  - connection = keep alive.
3. The Mobility Master then sends a second POST with 'close' connection type with the following information:
  - type = provision update,
  - the session ID received from Activate,
  - Device information that includes <serial number>, <mac-address>, <model>
  - certificate length
  - signed certificate
  - device certificate
4. Activate then responds with the following information:
  - type = provision update,
  - the same session ID that Activate assigned in the first response
  - status = success or failure
  - mode = master
  - the list of managed devices from the whitelist database, where each list entry contains a <mac-address>,<serial number>,<model>,<mode>,<hostname>, and <config group>

## Health Check Services for Managed Devices

The health-check feature uses ping-probes to measure WAN availability and latency on selected uplinks. Based upon the results of this health-check information, the managed device can continue to use its primary uplink, or failover to a backup link. Latency is calculated based on the round-trip time (RTT) of ping responses. You must define an uplink interface via the [uplink manager](#) and enable the health check feature before the results of this health check appear in the **WAN** section of the Monitoring Dashboard.



---

For more information on the WAN Dashboard, see [WAN on page 720](#).

---

ArubaOS supports policy-based routing on each uplink interface, which allows you specify the next hop to which packets are routed. ArubaOS supports multiple next-hop lists, to ensure connectivity in the event that a device on the list becomes unreachable. If you are using [Policy Based Routing](#), you can define global ping settings for all next-hop list destinations.

The **Health Check** section of the **Configuration > Services > WAN** tab allows you to configure probe measurement settings ping probe settings for the primary **WAN** uplink on the managed device, as well as for next hop links used by the policy-based routing (**PBR**) feature

**Table 48: WAN Health Check Settings**

Parameter	Description
Health Check	Click this check box to enable the health check features.
Remote Host IP/FQDN	IP address or fully qualified domain name (FQDN) of a remote host to which the managed device is connected. The WAN health check feature will check the connectivity to the managed device uplink to this device.
<b>WAN</b>	
Probe Mode	Click the <b>Probe Mode</b> drop-down list and select <b>ping</b> or <b>UDP</b> to enable this feature.
Probe Interval (sec)	The <b>Probe Interval</b> field specifies the probe interval, in seconds. The WAN health-check feature sends the number of probes defined by the <b>Pocket Burst per Probe</b> parameter during each probe interval. To change the default interval of 10 seconds, enter a new value into this field.
Packet Burst Per Probe	The <b>Pocket Burst per Probe</b> field specifies the number of probes to be sent during the probe interval. To change the default value of 5 probes, enter a new value into this field.
Probe Retries	The number of times the managed device will attempt to resend a probe.
Jitter Measurement	If the health check feature is configured to use <b>UDP</b> probe mode, the WAN health-check feature can measure jitter on the connection to the remote host by sending and measuring packets at fixed intervals.
<b>PBR</b>	
Probe Mode	Click the <b>Probe Mode</b> drop-down list and select <b>ping</b> to enable this feature.
Probe Interval (sec)	The <b>Probe Interval</b> field specifies the probe interval, in seconds. The WAN health-check feature sends the number of probes defined by the <b>Pocket Burst per Probe</b> parameter during each probe interval. To change the default interval of 10 seconds, enter a new value into this field.
Packet Burst Per Probe	The <b>Pocket Burst per Probe</b> field specifies the number of probes to be sent during the probe interval. To change the default value of 5 probes, enter a new value into this field.
Probe Retries	The number of times the managed device will attempt to resend a probe.

## WAN Optimization through IP Payload Compression

Data compression reduces the size of data frames that are transmitted over a network link, thereby reducing the time required to transmit the frame across the network. IP payload compression is one of the key features of the WAN bandwidth optimization solution, which is comprised of the following elements:

- IP Payload Compression

- Traffic Management and QoS
- Caching



---

WAN optimization through IP payload compression is not supported in a 7205 controller.

---

The managed device can send traffic to destinations other than the corporate headquarters on the same link, so payload compression is enabled on the IPsec tunnel between the managed device and Mobility Master. Dynamic compression is used for the IP payload to achieve a high compression ratio. No compression is applied to data such as an embedded image file that might already be in a compressed format. Such data does not compress well, and may even increase in size.

To enable payload compression:

1. In the **Managed Network** node hierarchy, navigate to the **Configuration > Services > WAN** tab.
2. Expand the **WAN Optimization** section.
3. Select the **Compression** option.
4. Click **Submit**.
5. Click **Pending Changes**.
6. In the **Pending Changes** window, select the check box and click **Deploy Changes**.

## WAN Interface Bandwidth Priorities

ArubaOS supports minimum bandwidth guarantees per traffic class, and allows critical delay-sensitive applications like voice and video to use more bandwidth and/or be scheduled with higher priority. Each interface can be associated with a scheduler profile, that supports four queues with different priority levels. If you use session ACLs to define traffic policies on the managed device, you can use the scheduler profile to automatically associate these different priority levels assigned by these policies to a scheduler profile queue.



---

For information on creating a traffic policy that assigns 802.1p priority levels to a specific application or application type, see [Configuring Firewall Policies on page 367](#)

---

Each scheduler profile queue is assigned a priority level and one of the following scheduler discipline types:

- **Strict priority:** The queue service is based exclusively on the priority of the queue, where the lower priority queues are not serviced until the higher priority queue is clear. With this option, the highest level priority is guaranteed as much bandwidth as possible, but there can be phases where the 2nd, 3rd and 4th priority queues may receive little or no bandwidth.
- **Deficit Round Robin (DRR) Weight:** The queue is assigned a percentage of available bandwidth.



---

You can define both strict priority and DRR Weight discipline types for a single scheduler profile.

---

## Using the WebUI

Use the following procedure to enable WLAN interface bandwidth priorities using the WAN scheduler feature,

1. In the **Managed Network** node hierarchy, navigate to **Configuration > Services > WAN**.
2. Expand the **WAN Scheduler** accordion.
3. Click + below the **WAN Scheduler Profiles** table to define a new scheduler profile.
  - a. In the **Priority** fields, enter one or more 802.1p priority levels (0-7) for each queue type. Each of the seven priority levels must be supported by one of the four queues.

- b. For each queue, click the **Scheduler Discipline** drop-down list and select the **Strict Priority** or **DDR Weight** discipline type. If you select the **DDR weight** option, enter the percentage of available bandwidth that should be made available to traffic in the selected queue. This field appears to the right of the **DDR weight** option.



---

If you configure both of strict priority and DRR weighted queues, the strict priority queues should be specified together continuously, followed by the DRR weighted queues. For example, if you want to specify two strict priority queues and two DRR weighted queues, configure queue 0 and 1 with the strict priority type, then configure queues 2 and 3 with a DRR priority type. You cannot alternate between strict priority and DRR weighted queues.

---

4. To assign the scheduler profile to a cellular or Gigabit Ethernet interface, click + below the **Assignments** table.
  - a. Click the **Ports** drop-down list to select an interface.
  - b. In the **Transmit Rate** field, enter the maximum transmit rate for the selected interface, in Mbps.
5. Create a firewall session policy that assigns a priority level to an application or application group. For details, see [Configuring Firewall Policies on page 367](#)

## Using the CLI

```
(host) [node] (config) #scheduler-profile <map-name> {priority-map <q0-q3> <que0-prio-list>} |
{queue-weights <q0-q3> <percentage_weight>}
```

```
(host) [node] (config) #interface cellular|gigabitethernet <slot/module/port> transmit max-rate
rate mbits <mbps> scheduler-profile <profile>
```

```
(host) [node] (config) #ip access-list session any any app salesforce permit priority 3
```

## Uplink Monitoring and Load Balancing

The ArubaOS Uplink Manager prioritizes cellular and wired uplinks, and checks and monitors the availability and quality of the connection to a remote host with specified FQDN or IP address. The status of these monitored uplinks appears on the [WAN](#) section of the WebUI dashboard.

By default, the cellular uplink is a lower priority than the wired uplink; making the wired link the primary link and the cellular link the secondary or backup link. A controller supports multiple 3G cellular uplinks in addition to its standard wired ports, providing redundancy in the event of a connection failure. If wired link cannot access the internet, the controller can fail over to a secondary cellular link and continue routing traffic.

### Uplink Load Balancing

WAN traffic can be balanced across two or more active uplinks from a managed device to a VPN concentrator (VPNC). The uplink load balancing feature supports both active and standby uplinks, so the traffic load is balanced across two wired uplinks, while the backup cellular uplink remains idle.

When a managed device has multiple active uplinks, uplink load balancing can modify the Internet Key Exchange (IKE) parameters for the managed device to create multiple managed device/VPNc IPsec tunnels, one on each uplink. Once multiple uplinks and IPsec tunnels are up, Layer-3 traffic can be load-balanced across these uplinks using specially created internal routing ACLs and nexthop lists.

### Load Balancing ACLs

When uplink load balancing is enabled, any Layer-3 traffic session that is not associated to a manually defined routing ACL will be managed by two specially created, internal ACLs placed at the bottom of the routing ACL table; the editable ACL **uplink-lb-cfg-racl**, followed by the non-editable ACL **uplink-lb-sys-racl**.

## Load Balancing Nexthop Lists

The uplink load balancing feature uses three special internally created nexthop lists:

**Load-balance-gateways** is used for load-balancing internet-bound traffic, and **load-balance-ipsecs** for managing encrypted traffic headed to the corporate headquarters. These nexthop lists include information about one nexthop gateway and one managed device / VPNC IPsec tunnel for each uplink, which are added to these lists so all nexthops are considered active and are available for routing.

The third nexthop list created by this feature is **traditional-ipsecs**, which is created by the load balancing feature, and used by uplinks in active-standby mode to send control plane traffic from the managed device to the VPNC.

## Configuring the Uplink Manager

Use the following procedure to disable or enable the uplink manager, and manage priorities for the wired and cellular connections. The uplink manager is enabled by default on managed device uplinks.

### In the WebUI

1. In the **Managed Network** node hierarchy, navigate to the **Configuration > Services > WAN** tab
2. Expand the **Uplinks** menu.
3. Select **Enable uplink** to enable the uplink manager.
4. Define a non-default priority for a wired and cellular connections in the **Default Wired Priority** and **Default Cellular Priority** fields. The default priority for a wired connection is 200, and the default priority for a cellular connection is 100.
5. (Optional) If you are configuring an uplink to a VPN concentrator, select **Load Balancing** to balance session traffic across multiple active uplinks. Do not enable this feature if the managed device has uplinks that connect directly to Mobility Master.
6. Click the **Mode** drop-down list and choose one of the following load balancing modes:
  - **Hash based:** Hash-based load balancing uses information from the packets being sent, (e.g. the source IP address, destination IP address, protocol and port numbers to determine how to load balance that traffic)
  - **Round Robin:** Traffic is equally distributed to all the active uplinks
  - **Session Count:** Traffic is balanced between the uplinks based upon the number of sessions managed by each link, so that the load for each active uplink stays within 5% of the other active uplinks.
7. In the **Max sessions per uplink (%)** field, enter the maximum percentage of total sessions that can be managed by any active uplink. The default value is 25%.
8. (Optional) Check the **Media Mode** option to reevaluate the selected uplink for the session if it is identified as a media session. By default, all sessions use the load-balance mode specified in [step 6 on page 224](#) . When you select this option, any time a session is identified as a media session, the uplink is reassigned to the optimal uplink for media sessions, based upon a separate media load-balancing algorithm.
9. (Optional) Enter a value into the **Latency threshold (ms)** field to optimize media sessions by defining the maximum latency allowed for media sessions in media mode. The supported range is 1 - 400 milliseconds, and the default is 20 ms.
10. (Optional) Enter a value into the **Jitter threshold (ms)** field to optimize media sessions by defining the maximum jitter allowed for media sessions in media mode. The supported range is 1 - 300 milliseconds, and the default is 5 ms.
11. Click + in the **Uplink VLANs** table and enter the following values to define a uplink VLAN for an uplink interface on the managed device.
  - **Link:** Link to which the VLAN is assigned
  - **VLAN ID:** VLAN ID number



- **Description:** Text string describing the VLAN
- **Enabled:** Select this drop-down list to disable or reenable the VLAN. New VLANs created on **Configuration > Services > WAN > Uplinks** are enabled by default.
- **Priority:** If load balanced is not enabled, this value defines the priority for the uplink in a active/standby uplink scenario.
- **Weight:** If the uplink is using load balancing in **session** mode, this value defines the weight given to the uplink in a active/active uplink scenario. An uplink with a higher weight will be assigned more session traffic than a uplink with a lower weigh. The supported range of values is 1-100.

12. Click **Submit**.

13. Click **Pending Changes**.

14. In the **Pending Changes** window, select the check box and click **Deploy Changes**.

## In the CLI

The following examples configure an uplink load-balancing solution via the Mobility Master command-line interface.

### Step 1: Configure the VPN concentrator

If a managed device terminates a secure tunnel on a VPN concentrator, you can issue the **vpn-peer peer-mac** command on the VPN concentrator configuration to enable load balancing on secure uplinks between the VPN concentrator and a managed device.

The following example enables load balancing on the uplinks between a managed device with the MAC address 01:00:5E:00:00:FF and a VPN concentrator:

```
(host) [node] (config) #vpn-peer peer-mac 01:00:5E:00:00:FF cert-auth factory-cert load-balance
```



If the peer device is an x86 server, then configure the MAC address of the management interface of the managed device. However, if the peer device is a hardware platform, you must provide the MAC address of the VLAN interface of the managed device

### Step 2: Enable the Uplink Manager

Issue the following command to enable the uplink manager:

```
(host) [node] (config) #uplink enable
```

### Step 3: Enable the Load Balancing

Issue the **uplink load-balance** command without any additional parameters to enable uplink load balancing:

```
(host) [node] (config) #uplink load-balance
```

### Step 4: (Optional) Configure Load Balancing Settings

Use the **uplink load-balance** command with the following parameters to configure additional uplink load-balancing settings. You cannot define load balancing settings unless the uplink manager and uplink load balancing features are already enabled.

```
(host) [node] (config) #uplink load-balance ?
mode                load-balancing mode
media-mode          load-balancing media mode
vlan                uplink vlan
```



To disable uplink load balancing between a managed device and VPN concentrator, disable the load balancing feature on the managed device (**no uplink load-balance**) *before* you disable load balancing on the VPN concentrator (**no vpn-peer peer-mac**).

## Policy Based Routing

A policy-based routing (PBR) rule is an ACL that can forward traffic as normal, or route traffic over a VPN tunnel specified by an IPsec map, routed to a nexthop router on a nexthop list, or redirected over an L3 GRE tunnel or tunnel group.



---

A Policy Based Routing (PBR) rule does not become active until it is applied to a VLAN interface or user role.

---

To associate a policy based routing rule with a managed device:

1. In the **Managed Network** node hierarchy, navigate to **Configuration > Interfaces > IP Routes**.
2. Expand the **Policy-Based Routing** menu.
3. Click + below the **Policies** table to create a new policy. When you add a new policy, the **Add Policy** window appears and prompts you to name the new policy. The policy type (route) is predefined in this window.
4. Select the policy in the **Policies** table. The **Policies > (policy name)** table appears.
5. Click + to add a new policy.
6. The **New Rule** window opens. Select a rule type
  - Access Control: Applies the rule to all traffic, or traffic using a specific service, protocol, or TCP/UDP port or range of ports.
  - Application: Applies a rule to an traffic for an application or application category.
7. Configure the rule parameters.

**Table 49:** Policy Based Routing ACL Rule Parameters

Field	Description
IP version	Specifies whether the policy applies to IPv4 or IPv6 traffic.
Source (required)	Source of the traffic, which can be one of the following: <ul style="list-style-type: none"><li>• any: Acts as a wildcard and applies to any source address.</li><li>• user: This refers to traffic from the wireless client.</li><li>• host: This refers to traffic from a specific host. When this option is chosen, you must configure the IP address of the host.</li><li>• network: This refers to a traffic that has a source IP from a subnet of IP addresses. When this option is chosen, you must configure the IP address and network mask of the subnet.</li><li>• alias: This refers to using an alias for a host or network. You configure the alias by navigating to the <b>Configuration &gt; Advanced Services &gt; Stateful Firewall &gt; Destination</b> page.</li></ul>
Destination (required)	Destination of the traffic, which can be configured in the same manner as Source.
Service/AP P	If you are creating an <b>access control</b> rule, select a type of traffic, which can be one of the following: <ul style="list-style-type: none"><li>• protocol: Using this option, you specify a different layer 4 protocol (other than TCP/UDP) by configuring the IP protocol value.</li><li>• any: This option specifies that this rule applies to any type of traffic.</li></ul>

Field	Description
	<ul style="list-style-type: none"> <li>service: Using this option, you use one of the pre-defined services (common protocols such as HTTPS, HTTP, and others) as the protocol to match for the rule to be applied. You can also specify a network service that you have manually configured. For details, see <a href="#">Creating a Network Service Alias on page 372</a>.</li> <li>tcp: A range of TCP port(s) that must be used by the traffic in order for the rule to be applied.</li> <li>udp: A range of UDP port(s) that must be used by the traffic in order for the rule to be applied.</li> </ul>
Scope	<p>If you are creating an <b>application</b> rule, select a type of traffic, which can be one of the following:</p> <ul style="list-style-type: none"> <li>application: Create a rule that applies to a specific application type. Click the <b>Application</b> drop-down list and select an application type.</li> <li>application category: Create a rule that applies to a specific application category. Click the <b>Application Category</b> drop-down list and select a category type.</li> </ul>
Action (required)	<p>The action that you want the controller to perform on a packet that matches the specified criteria. This can be one of the following:</p> <ul style="list-style-type: none"> <li>Forward Regularly: Packets are forwarded to their next destination without any changes.</li> <li>Forward to ipsec-map: Packets are forwarded through an IPsec tunnel defined by the specified IPsec map. You must specify the position of the forwarding or routing rule. (1 is first, default is last)</li> <li>Forward to next-hop-list: packets are forwarded to the highest priority active device on the selected next hop list. You must also specify the position of the forwarding or routing rule (1 is first, default is last). For more information on next-hop lists, see <a href="#">Uplink Routing using Nexthop Lists on page 227</a></li> <li>Forward to tunnel: Packets are forwarded through the tunnel with the specified tunnel ID. You must also specify the position of the forwarding or routing rule (1 is first, default is last). For more information on GRE tunnels, see <a href="#">Configuring GRE Tunnels on page 104</a>.</li> <li>Forward to tunnel group: Packets are forwarded through the active tunnel in a GRE tunnel group. You must also specify the position of the forwarding or routing rule (1 is first, default is last). For more information on tunnel groups, see <a href="#">GRE Tunnel Groups on page 110</a>.</li> </ul>
Position	<p>(Optional) Define a position for the rule in the ACL. Rules processed according to their position numbers, and new Rules are added at the end of an ACL by default. A position of 1 puts the rule at the top of the list.</p>

8. Click **Submit**.

9. Click **Pending Changes**.

10. In the **Pending Changes** window, select the check box and click **Deploy Changes**.

### Targets for PBR Rules

Use the command `routing-policy-map` to associate a routing ACL with a specific user role on a managed device.

- If you selected the VLAN type, click the **Target** drop-down list and select a VLAN ID to apply the rule to the VLAN interface's inbound traffic.

## Uplink Routing using Nexthop Lists

If the controller uses policy-based routing to forward packets to a next hop device, a next-hop list ensures that if the primary next-hop device becomes unreachable, the packets matching the policy can still reach their destination. For more information on nexthop devices, see [Policy Based Routing on page 226](#).

To define a next-hop list:

1. In the **Managed Network** node hierarchy, navigate to **Configuration > Interfaces > IP Routes**.
2. Expand the **Next Hop Configuration** menu.
3. (Optional) In the **Health check probe interval** field, specify the probe interval, in seconds. The WAN health-check feature sends the number of probes defined by the **Packet Burst per Probe** parameter during each probe interval. To change the default interval of 10 seconds, enter a new value into this field.
4. (Optional) In the **Packet Burst per Probe** field, specify the number of probes to be sent during the probe interval. To change the default value of 5 probes, enter a new value into this field.
5. Click + below the **NextHop Table** to open a pop-up window that allows you to configure the following next-hop settings:

**Figure 28** Managed Device Next-Hop Settings

Parameter	Description
NextHop-list name	Name for the new nextHop list.
NextHop IP / DHCP	<p>IP address of the nextHop device or the VLAN ID of the VLAN used by the nextHop device. If the VLAN gets an IP address using DHCP, and the default gateway is determined by the VLAN interface, the gateway IP is used as the nextHop IP address. When you click + to define a NextHop IP or DHCP value, a pop-up list appears and field requires you to select either the <b>IP</b> or <b>DHCP</b> option.</p> <ul style="list-style-type: none"> <li>• If you selected <b>IP</b>, enter the IP address and priority of the nextHop device in the <b>NextHop Value</b> and <b>Priority</b> fields.</li> <li>• If you selected <b>DHCP</b>, enter the VLAN ID and priority of the nextHop device in the <b>VLAN IP</b> and <b>Priority</b> fields.</li> </ul>
IPsec map	A nextHop list may require policy-based redirection of traffic to different VPN tunnels. Click the IPsec map drop-down list to select an IPsec map to redirect traffic through IPsec tunnels.
Preemptive-Failover	If preemptive failover is disabled and the highest-priority device on the nextHop list is disabled, the new primary nextHop device remains the primary even when the original device comes back online.

6. Click **Submit**.
7. Click **Pending Changes**.
8. In the **Pending Changes** window, select the check box and click **Deploy Changes**.

### Targets for PBR Rules

A Policy Based Routing (PBR) rule does not become active until it is applied to a VLAN interface or user role. To define a target for a PBR rule:

1. In the **Managed Network** node hierarchy, navigate to **Configuration > Interfaces > IP Routes**.
2. Select the **PBR** sub-tab.
3. Click the **Add** button below the **Target** table.
4. Click the PBR Rule Name drop-down list and select the rule to be applied to the target.
5. Select the target type: **VLAN** or **User Role**.

- If you selected the VLAN type, click the **Target** drop-down list and select a VLAN ID to apply the rule to the VLAN interface's inbound traffic.
  - If you selected the **User Role** type, click the **Target** drop-down list and select a user role. The rule will be applied to traffic from clients with the selected user role.
6. Click **Done**.
  7. Click **Submit**.
  8. Click **Pending Changes**.
  9. In the **Pending Changes** window, select the check box and click **Deploy Changes**.

## Address Pool Management

Each managed device supports one or more client DHCP pools; a pool of IP addresses that can be assigned to clients associated to that managed device, or to the node itself. In addition to the DHCP pool, the Mobility Master also allows you to create separate pools of addresses a managed device can use to dynamically assign to its uplink VLANs, use for NAT translation, or use to create a GRE tunnel to the Mobility Master. These address pools are pushed out to each managed node when it comes up on the network. If a managed node is removed from the master, the IP addresses allocated to that managed device can be reused and reassigned to a new managed node.

ArubaOS supports the following pool types:

- **DHCP pools:** When you create DHCP pool for a configuration group, that pool defines a set of IP addresses that can be assigned to client associated to managed devices in that group.
- **VLAN Pools:** Mobility Master must have a separate VLAN pool defined for each VLAN used by its managed device. A VLAN pool allocates a static, continuous block of multiple IP addresses to each managed device. The managed device acts as a DNS proxy server and dynamically assign IP addresses from its allocated pool to each AP or client on the VLAN.
- **Tunnel Pools:** The tunnel pool on a managed node defines a range of IP addresses that the managed node uses to create a GRE tunnel within the IPsec tunnel back to the Mobility Master. Unlike VLAN pools, which allocates multiple addresses to each managed node VLAN, the tunnel DHCP pool assigns a single tunnel IP address to each managed node.
- **NAT Pools:** Used by the managed device for source NAT translation. You can use a NAT pool to create a firewall policy rule to perform network address translation (NAT) on packets matching the rule.
- **VPN Pools:** The VPN pool defines a group of IP addresses assigned to VPN clients.

### DHCP Address Pools

Use the **Configuration > Services > DHCP Server** page to configure a pool of DHCP addresses. The managed device can use one of the addresses from this pool for its own IP address, and/or assign addresses in the pool to clients associating to that node. To configure a DHCP address pool:

1. In the **Managed Network** node hierarchy, navigate to **Configuration > Services > DHCP Server**.
2. Click + below the **Pool Configuration** table.
3. Define the following values for the pool, then click **Submit**.
4. Click **Pending Changes**.
5. In the **Pending Changes** window, select the check box and click **Deploy Changes**.

**Figure 29** DHCP Pool Configuration Parameters

Parameter	Description
IP version	Assign IPv4 or IPv6 addresses
Pool Name	Give a name to the new address pool
Default router	IP address of the default router for the DHCP client. The client should be on the same subnetwork as the default router. You can specify up to eight IP addresses.
DNS Server	IP address of the DNS server. You can specify up to eight IP addresses. Multiple IP addresses must be separated by spaces.
Import from DHCP/PPPoE	Select this option to use the DNS server address obtained through PPPoE or DHCP.
Domain Name	Domain name to which the client belongs.
WINS	IP address of a NetBIOS Windows Internet Naming Service (WINS) server. You can specify up to eight IP addresses. Multiple IP addresses must be separated by spaces.
Import from DHCP/PPPoE	Use the NetBIOS name server address obtained through PPPoE or DHCP.
Lease Days	The number of days that the assigned IP address is valid for the client.
Lease Hours	The number of hours that the assigned IP address is valid for the client.
Lease Minutes	The number of minutes that the assigned IP address is valid for the client.
Network IP Address Type	Choose <b>Static</b> to add a static IP address and netmask to the pool, or select <b>Dynamic</b> to define a range of addresses that the DHCP server may assign to clients. <ul style="list-style-type: none"><li>• If you select <b>Static</b>, enter an IP address and netmask.</li><li>• If you select <b>Dynamic</b>, enter the starting and ending IP address for the address range, as well as the maximum number of hosts to be supported by the pool.</li></ul>
Option	Click <b>Option</b> to apply a client-specific option code and IP address or text string. See RFC 2132, "DHCP Options and BOOTP Vendor Extensions".

To assign a DHCP address pool to a VLAN:

1. In the **Managed Network** node hierarchy, navigate to **Configuration > interfaces > VLANs**.
2. In the **VLANs** table, select the name of the VLAN to which you want to assign the DHCP pool. A **VLANs > (selected VLAN)** table appears
3. Select the VLAN ID of the VLAN to use the address pool. The **Port Members** table opens.
4. In the **Port Members** table, select the IPv4 subtab.
5. Click the **IP assignment** field, and select DHCP Pool.
6. Click the **DHCP pool** drop-down list and select a DHCP to associate to the VLAN.
7. Click **Submit**.

8. Click **Pending Changes**.
9. In the **Pending Changes** window, select the check box and click **Deploy Changes**.

## VLAN Pools

To create a VLAN pool for uplink interfaces on a managed device:

1. In the **Managed Network** node hierarchy, navigate to **Configuration > Interfaces > Pool Management**.
1. Expand the **VLAN Pools** section
2. Click + below the **VLAN Pools** table to create a new VLAN pool
3. In the **Pool name** field, enter a name to the new pool.
4. In the **Start IP address** field, enter the IP address at the start of the range of addresses.
5. In the **End IP address** field, enter the IP address at the end of the range of addresses.
6. Click **Submit**.
7. Click **Pending Changes**.
8. In the **Pending Changes** window, select the check box and click **Deploy Changes**.

To assign a VLAN address pool to a VLAN:

1. Navigate to **Configuration > interfaces > VLANs**.
2. In the **VLANs** table, select the name of the VLAN to which you want to assign the DHCP pool. A **VLANs > (selected VLAN)** table appears
3. Select the VLAN ID of the VLAN to use the address pool. The **Port Members** table opens.
4. In the **Port Members** table, select the IPv4 subtab.
5. Click the **IP assignment** field, and select VLAN Pool.
6. Click the **VLAN Pool** drop-down list and select a DHCP to associate to the VLAN.

## NAT Pools

To create a pool of addresses the managed device can use for Network Address Translation:

1. In the **Managed Network** node hierarchy, navigate to **Configuration > Interfaces > Pool Management**.
1. Expand the **VLAN Pools** section
2. Click + below the **VLAN Pools** table to create a new VLAN pool
3. In the **Pool name** field, enter a name to the new pool.
4. In the **Start IP address** field, enter the IP address at the start of the range of addresses.
5. In the **End IP address** field, enter the IP address at the end of the range of addresses.
6. Click **Submit**.
7. Click **Pending Changes**.
8. In the **Pending Changes** window, select the check box and click **Deploy Changes**.

Nat pools can associated to firewall policy rules and VPN configurations.

- For information on creating a firewall policy rule that uses the NAT pool to performs NAT translation on matching packets. see [Configuring Firewall Policies on page 367](#).
- To apply network address translation to VPN clients , navigate to **Configuration > Services > VPN > General VPN**, enable the **source-nat** option, then click the **NAT** drop-down list and select the NAT pool you just created.

## Tunnel Pools

Use tunnel pools to create a pool of IP addresses used by the managed device to create a GRE tunnel to the Mobility Master. Each managed device uses a single IP address from this pool.

1. In the **Managed Network** node hierarchy, navigate to **Configuration > Interfaces > Pool Management**.
2. Expand the **Tunnel Pools** section
3. Click + below the **Tunnel Pools** table to create a new VLAN pool
4. In the **Pool name** field, enter a name to the new pool.
5. In the **Start IP address** field, enter the IP address at the start of the range of addresses.
6. In the **End IP address** field, enter the IP address at the end of the range of addresses.
7. Click **Submit**.
8. Click **Pending Changes**.
9. In the **Pending Changes** window, select the check box and click **Deploy Changes**.

To associate a tunnel pool to a GRE tunnel:

1. In the **Managed Network** node hierarchy, navigate to **Configuration > Interfaces > GRE Tunnels**.
2. Select an entry in the **GRE Tunnels** table to associate a tunnel pool to that GRE tunnel.
3. In the **IPv4 Address Type** field, select the **Dynamic** option.
4. Click the **Dynamic IP Address Pool** drop-down list and select a tunnel pool.
5. Click **Submit**.
6. Click **Pending Changes**.
7. In the **Pending Changes** window, select the check box and click **Deploy Changes**.

## VPN Pools

To create a pool of addresses used by VPN clients :

1. In the **Managed Network** node hierarchy, navigate to **Configuration > Services > VPN**.
1. Expand the **General VPN** section
2. Click + below the **Address Pools** table to create a new VPN address pool
3. In the **Pool name** field, enter a name to the new pool.
4. In the **Start IP address** field, enter the IP address at the start of the range of addresses.
5. In the **End IP address** field, enter the IP address at the end of the range of addresses.
6. Click **Submit**.
7. Click **Pending Changes**.
8. In the **Pending Changes** window, select the check box and click **Deploy Changes**.

## Configuring WAN Authentication Survivability

Enable WAN survivability for managed devices on your network by navigating to the **Configuration > Authentication > Advanced** tab, then selecting the Survivability tab.

The survivability settings on this tab are described in [Table 50](#).



---

For additional information on WAN Authentication Survivability, including authentication workflows and supported client and authentication types see the [WAN Authentication Survivability Overview on page 211](#).

---



**Table 50: WAN Authentication Survivability for a Managed Device**

Parameter	Description
Enable Auth-Survivability	<p>This parameter controls whether to use the Survival Server when no other authentication servers in the server group are in-service.</p> <p>This parameter also controls whether to store the user access credential in the Survival Server when it is authenticated by an external RADIUS or LDAP server in the server group. Authentication Survivability is enabled or disabled at each controller. This parameter is disabled by default.</p> <p><b>NOTE:</b> Authentication Survivability will not activate if Authentication Server Dead Time is configured as 0. For more information on configuring Authentication Server Dead Time, see <a href="#">Configuring Authentication Timers on page 201</a>.</p>
Authentication Server Certificate	<p>This parameter allows you to view the name of the server certificate used by the local Survival Server. The local Survival Server is provided with a default server certificate from ArubaOS . The customer server certificate must be imported into the managed device first, and then you can assign the server certificate to the local Survival Server.</p>
Cache Lifetime (hrs)	<p>This parameter specifies the lifetime in hours for the cached access credential in the local Survival Server. When the specified cache-lifetime expires, the cached access credential is deleted from the managed device.</p> <p>Configured authentication servers are put into the out-of-service (OOS) state when authentication requests time out. The managed device picks the next server from the server group when the previous server times out or fails.</p> <p>When there are no more servers available from the server group, the local Survival Server processes the authentication request. When the client is authenticated with the local Survival Server, the previously stored Key Reply attributes are included in the RADIUS response.</p> <p>The Cache Lifetime range is from 1 to 72 hours. The default is 24 hours.</p>
Certificate Type	<p>Select the certificate to be used for client authentication.</p>

## Preventing WAN Link Failure on Virtual APs

In managed device deployments, the managed devices are connected across the WAN link from the Mobility Master to the RADIUS server. A WAN link outage will result in service outage as new users cannot be authenticated to 802.1X Virtual APs. This feature provides limited connectivity to managed devices even when the WAN link is down. To provide connectivity when the WAN link is down, open and PSK SSID Virtual APs (VAPs) are available at all times and the user can connect to these VAPs instead of the main 802.1X Virtual AP.




---

Currently, this feature is targeted for Campus APs in managed device deployments.

---

When all the WAN links are down, an AP management module in the controller updates the link state using the notification it receives from the health check manager. Depending on the link state, the new set of Virtual APs are made available to the users, ensuring minimum service depending on the deployment. The VAPs for WAN link failure feature can be configured using the Mobility Master WebUI or command-line interface.

### In the WebUI

1. In the **Managed Network** node hierarchy, navigate to **Configuration > System > Profiles** page.
2. In the **All Profiles** pane, expand the **Wireless LAN** menu.
3. Expand the Virtual AP menu.

4. Select a existing virtual AP profile.
5. Expand the **Advanced** section.
6. The **WAN Operation Mode** drop-down list supports the **Primary**, **Always**, and **Backup** WAN modes. To enable WAN link failure, set this mode to **backup**.
7. Click **Submit**.
8. Click **Pending Changes**.
9. In the **Pending Changes** window, select the check box and click **Deploy Changes**.

802.1X is an Institute of Electrical and Electronics Engineers (IEEE) standard that provides an authentication framework for WLANs. 802.1X uses the Extensible Authentication Protocol (EAP) to exchange messages during the authentication process. The authentication protocols that operate inside the 802.1X framework that are suitable for wireless networks include EAP-Transport Layer Security (EAP-TLS), Protected EAP (PEAP), and EAP-Tunneled TLS (EAP-TTLS). These protocols allow the network to authenticate the client while also allowing the client to authenticate the network.

This chapter describes the following topics:

- [Understanding 802.1X Authentication on page 235](#)
- [Configuring 802.1X Authentication on page 238](#)
- [Sample Configurations on page 248](#)
- [Performing Advanced Configuration Options for 802.1X on page 266](#)

Other types of authentication not discussed in this section can be found in the following sections of this guide:

- Captive portal authentication: [Configuring Captive Portal Authentication Profiles on page 301](#)
- VPN authentication: [Planning a VPN Configuration on page 338](#)
- MAC authentication: [Configuring MAC-Based Authentication on page 204](#)
- Stateful 802.1X, stateful NTLM, and WISPr authentication: [Stateful and WISPr Authentication on page 271](#)

## Understanding 802.1X Authentication

802.1X authentication consists of three components:

- The *supplicant*, or client, is the device attempting to gain access to the network. You can configure the Aruba user-centric network to support 802.1X authentication for wired users and wireless users.
- The *authenticator* is the gatekeeper to the network and permits or denies access to the supplicants.
- The *Aruba managed device* acts as the authenticator, relaying information between the authentication server and supplicant. The EAP type must be consistent between the authentication server and supplicant, and is transparent to the managed device.

The authentication server provides a database of information required for authentication, and informs the authenticator to deny or permit access to the supplicant.

The 802.1X authentication server is typically an EAP-compliant Remote Access Dial-In User Service (RADIUS) server which can authenticate either users (through passwords or certificates) or the client computer.

An example of an 802.1X authentication server is the Internet Authentication Service (IAS) in Windows (see [http://technet.microsoft.com/en-us/library/cc759077\(WS.10\).aspx](http://technet.microsoft.com/en-us/library/cc759077(WS.10).aspx)).

In Aruba user-centric networks, you can terminate the 802.1X authentication on the managed device. The managed device passes user authentication to its internal database or to a “backend” non-802.1X server. This feature, also called *AAA FastConnect*, is useful for deployments where an 802.1X EAP-compliant RADIUS server is not available or required for authentication.

## Supported EAP Types

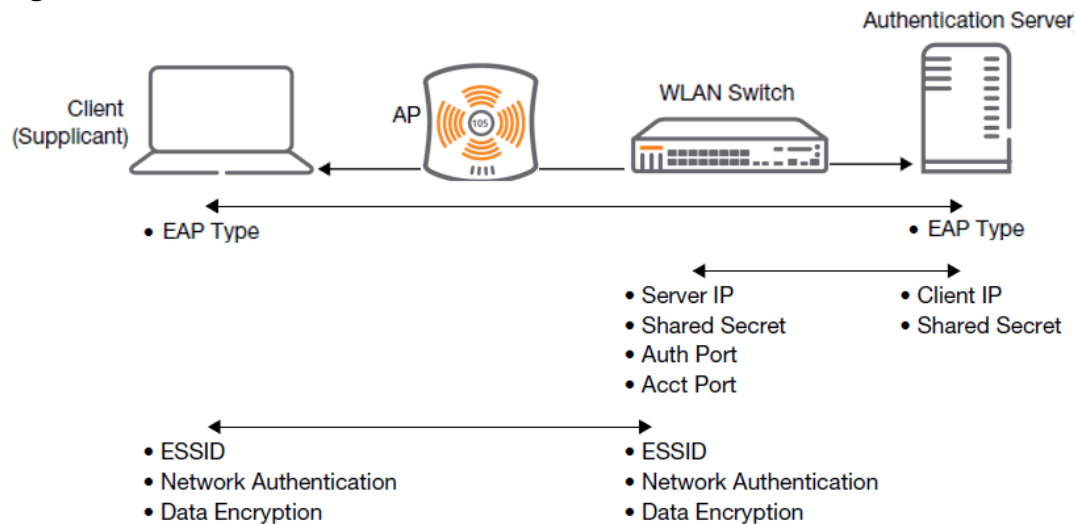
Following is the list of supported EAP types:

- PEAP — Protected EAP (PEAP) is an 802.1X authentication method that uses server-side public key certificates to authenticate clients with the server. The PEAP authentication creates an encrypted SSL / TLS tunnel between the client and the authentication server. The exchange of information is encrypted and stored in the tunnel to ensure that the user credentials are kept secure.
- EAP-GTC—The EAP-GTC (Generic Token Card) type uses clear text method to exchange authentication controls between the client and the server. Since the authentication mechanism uses the one-time tokens (generated by the card), this method of credential exchange is considered safe. In addition, EAP-GTC is used in PEAP or TTLS tunnels in wireless environments. The EAP-GTC is described in RFC 2284.
- EAP-AKA—The EAP-AKA (Authentication and Key Agreement) authentication mechanism is typically used in mobile networks that include Universal Mobile Telecommunication Systems (UMTS) and CDMA 2000. This method uses the information stored in the Subscriber Identity Module (SIM) for authentication. The EAP-AKA is described in RFC 4187.
- EAP-FAST—The EAP-FAST (Flexible Authentication via Secure Tunneling) is an alternative authentication method to PEAP. This method uses the Protected Access Credential (PAC) for verifying clients on the network. The EAP-FAST is described in RFC 4851.
- EAP-MD5—The EAP-MD5 method verifies MD5 hash of a user password for authentication. This method is commonly used in a trusted network. The EAP-MD5 is described in RFC 2284.
- EAP-POTP—The EAP type 32 is supported. Complete details are described in RFC 4793.
- EAP-SIM—The EAP-SIM (Subscriber Identity Module) uses Global System for Mobile Communication (GSM) Subscriber Identity Module (SIM) for authentication and session key distribution. This authentication mechanism includes network authentication, user anonymity support, result indication, and fast re-authentication procedure. Complete details about this authentication mechanism is described in RFC 4186.
- EAP-TLS—The EAP-TLS (Transport Layer Security) uses Public key Infrastructure (PKI) to set up authentication with a RADIUS server or any authentication server. This method requires the use of a client-side certificate for communicating with the authentication server. The EAP-TLS is described in RFC 5216.
- EAP-TLV—The EAP-TLV (type-length-value) method allows you to add additional information in an EAP message. Often this method is used to provide more information about an EAP message such as status information or authorization data. This method is always used after a typical EAP authentication process.
- EAP-TTLS—The EAP-TTLS (Tunneled Transport Layer Security) method uses server-side certificates to set up authentication between clients and servers. The actual authentication is, however, performed using passwords. Complete details about EAP-TTLS is described in RFC 5281.
- LEAP—Lightweight Extensible Authentication Protocol (LEAP) uses dynamic WEP keys and mutual authentication between the client and the RADIUS server.
- ZLXEAP—ZoneLabs EAP is an EAP method that has been allocated EAP Type 44 by IANA. For more information, visit <http://tools.ietf.org/html/draft-bersani-eap-synthesis-sharedkeymethods-00#page-30>.

## Configuring Authentication with a RADIUS Server

See [Table 51](#) for an overview of the parameters that you need to configure on authentication components when the authentication server is an 802.1X EAP-compliant RADIUS server.

**Figure 30** 802.1X Authentication with a RADIUS Server



The supplicant and the authentication server must be configured to use the same EAP type. The managed device does not need to know the EAP type used between the supplicant and authentication server.

For the managed device to communicate with the authentication server, you must configure the IP address, authentication port, and accounting port of the server on the managed device. The authentication server must be configured with the IP address of the RADIUS client, which is the managed device in this case. Both the managed device and the authentication server must be configured to use the same shared secret.



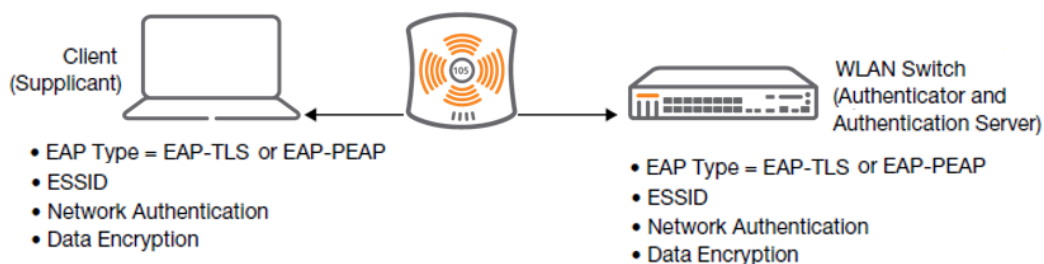
Additional information on EAP types supported in a Windows environment, Microsoft supplicants, and authentication servers, is available at [http://technet.microsoft.com/en-us/library/cc782851\(WS.10\).aspx](http://technet.microsoft.com/en-us/library/cc782851(WS.10).aspx).

The client communicates with the managed device through a GRE tunnel to form an association with an AP and to get authenticated in the network. Therefore, the network authentication and encryption configured for an ESSID must be the same on both the client and the managed device.

### Configuring Authentication Terminated on managed device

User authentication is performed either via the managed device's internal database or a non-802.1X server. See [802.1X Authentication Profile WebUI Parameters on page 239](#) for an overview of the parameters that you need to configure on 802.1X authentication components when 802.1X authentication is terminated on the managed device (AAA FastConnect).

**Figure 31** 802.1X Authentication with Termination on Managed device



In this scenario, the supplicant is configured for EAP-Transport Layer Security (TLS) or EAP-Protected EAP (PEAP).

- EAP-TLS is used with smart card user authentication. A smart card holds a digital certificate which, with the user-entered personal identification number (PIN), allows the user to be authenticated on the network. EAP-TLS relies on digital certificates to verify the identities of both the client and the server.  
EAP-TLS requires that you import server and certification authority (CA) certificates onto the managed device (see [Configuring and Using Certificates with AAA FastConnect on page 244](#)). The client certificate is verified on the managed device (the client certificate must be signed by a known CA) before the username is checked on the authentication server.
- EAP-PEAP uses TLS to create an encrypted tunnel. Within the tunnel, one of the following “inner EAP” methods is used:
  - EAP-Generic Token Card (GTC): Described in RFC 2284, this EAP method permits the transfer of unencrypted usernames and passwords from client to server. The main uses for EAP-GTC are one-time token cards such as SecureID and the use of an LDAP or RADIUS server as the user authentication server. You can also enable caching of user credentials on the managed device as a backup to an external authentication server.
  - EAP-Microsoft Challenge Handshake Authentication Protocol version 2 (MS-CHAPv2): Described in RFC 2759, this EAP method is widely supported by Microsoft clients. A RADIUS server must be used as the backend authentication server.

If you use the managed device’s internal database for user authentication, you need to add the names and passwords of the users to be authenticated. If you use an LDAP server for user authentication, you need to configure both the LDAP server and the user IDs and passwords on the managed device. If you use a RADIUS server for user authentication, you need to configure the RADIUS server on the managed device.

## Configuring 802.1X Authentication

On the managed device, use the following steps to configure a wireless network that uses 802.1X authentication:

1. Configure the VLANs to which the authenticated users will be assigned. See [Network Configuration Parameters on page 86](#).
2. Configure policies and roles. You can specify a default role for users who are successfully authenticated using 802.1X. You can also configure server derivation rules to assign a user role based on attributes returned by the authentication server; server-derived user roles take precedence over default roles. For more information about policies and roles, see [Roles and Policies on page 367](#).




---

The Policy Enforcement Firewall Virtual Private Network (PEFV) module provides identity-based security for wired and wireless users and must be installed on the managed device. The stateful firewall allows user classification based on user identity, device type, location, and time of day to provide differentiated access for different classes of users. For information about obtaining and installing licenses, refer to the *Aruba Mobility Master Licensing Guide*.

---

3. Configure the authentication server(s) and server group. The server can be an 802.1X RADIUS server or, if you use AAA FastConnect, a non-802.1X server or the managed device’s internal database. If you use EAP-GTC within a PEAP tunnel, configure an LDAP or RADIUS server as the authentication server (see [Authentication Servers on page 180](#)). If you use EAP-TLS, import server and CA certificates on the managed device (see [Configuring and Using Certificates with AAA FastConnect on page 244](#)).
4. Configure the AAA profile:
  - Select the 802.1X default user role.
  - Select the server group you previously configured for the 802.1X authentication server group.
5. Configure the 802.1X authentication profile. See [In the WebUI on page 261](#).
6. Configure the virtual AP profile for an AP group or for a specific AP:
  - Select the AAA profile you previously configured.

- In the SSID profile, configure the WLAN for 802.1X authentication.

For details on how to complete the above steps, see [Sample Configurations on page 248](#).

## In the WebUI

This section describes how to create and configure a new instance of an 802.1X authentication profile in the WebUI or the CLI.

1. In a **Managed Network** node hierarchy, navigate to the **Configuration > Authentication > L2 Authentication** tab.
2. In the **L2 Authentication** table, select **802.1X Authentication** Profile.
3. Click + in the **802.1X Authentication Profile: New Profile**.
4. Change the settings described in [Table 51](#) as desired, then click **Save As**.
5. Enter a name for the new profile in the **Profile Name** field.

**Table 51:** 802.1X Authentication Profile WebUI Parameters

Parameter	Description
Max authentication failures	Number of times a user can try to log in with wrong credentials after which the user is blacklisted as a security threat. Set to 0 to disable blacklisting, otherwise enter a non-zero integer to blacklist the user after the specified number of failures. Range: 0-5 failures. Default: 0 failure. <b>NOTE:</b> This option may require a license.
Enforce Machine Authentication	Select the Enforce Machine Authentication option to require machine authentication. This option is also available on the <b>Basic</b> settings tab. <b>NOTE:</b> This option may require a license.
Machine Authentication Default Machine Role	Default role assigned to the user after 802.1X authentication. The default role for this setting is the "guest" role.
Machine Authentication Cache Timeout	The timeout, in hours, for machine authentication. The allowed range of values is 1-1000 hours, and the default value is 24 hours.
Blacklist on Machine Authentication Failure	Select this check box to blacklist a client if machine authentication fails. This setting is disabled by default.
Machine Authentication Default User Role	Default role assigned to the user after completing only machine authentication. The default role for this setting is the "guest" role.
Interval between Identity Requests	Interval, in seconds, between identity request retries. Range: 1-65535 seconds. Default: 30 seconds.

**Table 51: 802.1X Authentication Profile WebUI Parameters**

Parameter	Description
Quiet Period after Failed Authentication	The enforced quiet period interval, in seconds, following failed authentication. Range: 1-65535 seconds. Default: 30 seconds.
Reauthentication Interval	Interval, in seconds, between reauthentication attempts. Range: 60-864000 seconds. Default: 86400 seconds (1 day).
Use Server provided Reauthentication Interval	Select this option to override any user-defined reauthentication interval and use the reauthentication period defined by the authentication server.
Multicast Key Rotation Time Interval	Interval, in seconds, between multicast key rotation. Range: 60-864000 seconds. Default: 1800 seconds.
Unicast Key Rotation Time Interval	Interval, in seconds, between unicast key rotation. Range: 60-864000 seconds. Default: 900 seconds.
Authentication Server Retry Interval	Server group retry interval, in seconds. Range: 5-65535 seconds. Default: 30 seconds.
Authentication Server Retry Count	Maximum number of authentication requests that are sent to server group. Range: 0-3 requests. Default: 2 requests.
Framed MTU	Sets the framed Maximum Transmission Unit (MTU) attribute sent to the authentication server. Range: 500-1500 bytes. Default: 1100 bytes.
Max number of requests sent during an Auth attempt	Maximum number of times ID requests are sent to the client. Range: 1-10 retries. Default: 3 retries.
Maximum Number of Reauthentication Attempts	Number of times a user can try to log in with wrong credentials after which the user is blacklisted as a security threat. Set to 0 to disable blacklisting, otherwise enter a value from 0-5 to blacklist the user after the specified number of failures. <b>NOTE:</b> If changed from its default value, this option may require a license.



**Table 51: 802.1X Authentication Profile WebUI Parameters**

Parameter	Description
Maximum number of times Held State can be bypassed	<p>Number of consecutive authentication failures which, when reached, causes the managed device to not respond to authentication requests from a client while the managed device is in a held state after the authentication failure. Before this number is reached, the managed device responds to authentication requests from the client even while the managed device is in its held state.</p> <p>(This parameter is applicable when 802.1X authentication is terminated on the managed device, also known as AAA FastConnect.) The allowed range of values for this parameter is 0-3 failures, and the default value is 0.</p>
Dynamic WEP Key Message Retry Count	<p>Set the Number of times WPA/WPA2 Key Messages are retried.</p> <p>Range: 1-5 retries.</p> <p>Default: 3 retries.</p>
Dynamic WEP Key Size	<p>The default dynamic WEP key size is 128 bits, If desired, you can change this parameter to 40 bits.</p>
Interval between WPA/WPA2 Key Messages	<p>Interval, in milliseconds, between each WPA key exchanges.</p> <p>Range: 1000-5000 ms.</p> <p>Default: 1000 ms.</p>
Delay between EAP-Success and WPA2 Unicast Key Exchange	<p>Interval, in milliseconds, between EAP-Success and unicast key exchanges.</p> <p>Range: 0-2000 ms.</p> <p>Default: 0 ms (no delay).</p>
Delay between WPA/WPA2 Unicast Key and Group Key Exchange	<p>Interval, in milliseconds, between unicast and multicast key exchange. Time interval in milliseconds.</p> <p>Range: 0-2000.</p> <p>Default: 0 (no delay).</p>
Time interval after which the PMKSA will be deleted	<p>The time interval after which the PMKSA (Pairwise Master Key Security Association) cache is deleted. Time interval in Hours.</p> <p>Range: 1-2000.</p> <p>Default: 8.</p>
WPA/WPA2 Key Message Retry Count	<p>Number of times WPA/WPA2 key messages are retried.</p> <p>Range: 1-5 retries.</p> <p>Default: 3 retries.</p>
Multicast Key Rotation	<p>Select this check box to enable multicast key rotation. This feature is disabled by default.</p>
Unicast Key Rotation	<p>Select this check box to enable unicast key rotation. This feature is disabled by default.</p>

**Table 51: 802.1X Authentication Profile WebUI Parameters**

Parameter	Description
Reauthentication	<p>Select the Reauthentication check box to force the client to do a 802.1X reauthentication after the expiration of the default timer for reauthentication. (The default value of the timer is 24 hours.) If the user fails to reauthenticate with valid credentials, the state of the user is cleared. If derivation rules are used to classify 802.1X-authenticated users, then the reauthentication timer per role overrides this setting.</p> <p>This option is disabled by default.</p>
Opportunistic Key Caching	<p>By default, the 802.1X authentication profile enables a cached pairwise master key (PMK) which is derived through a client and an associated AP. This key is used when the client roams to a new AP. This allows clients faster roaming without a full 802.1X authentication. Uncheck this option to disable this feature.</p> <p><b>NOTE:</b> Make sure that the wireless client (the 802.1X supplicant) supports this feature. If the client does not support this feature, the client will attempt to renegotiate the key whenever it roams to a new AP. As a result, the key cached on the managed device can be out of sync with the client's key.</p>
Validate PMKID	<p>This parameter instructs the managed device to check the pairwise master key (PMK) ID sent by the client. When you enable this option, the client must send a PMKID in the associate or reassociate frame to indicate that it supports OKC or PMK caching; otherwise, full 802.1X authentication takes place.</p> <p><b>NOTE:</b> This feature is optional, since most clients that support OKC and PMK caching do not send the PMKID in their association request.</p>
Termination	<p>Select this check box to allow 802.1X authentication to terminate on the managed device. This option is disabled by default.</p>
Termination EAP-Type	<p>If you enable termination, click either EAP-PEAP or EAP-TLS to select a Extensible Authentication Protocol (EAP) method.</p>
Termination Inner EAP-Type	<p>If you use EAP-PEAP as the EAP method, specify one of the following inner EAP types:</p> <ul style="list-style-type: none"> <li>• <b>eap-gtc:</b> Described in RFC 2284, this EAP method permits the transfer of unencrypted usernames and passwords from client to server. The main uses for EAP-GTC are one-time token cards such as SecureID and the use of LDAP or RADIUS as the user authentication server. You can also enable caching of user credentials on the managed device as a backup to an external authentication server.</li> <li>• <b>eap-mschapv2:</b> Described in RFC 2759, this EAP method is widely supported by Microsoft clients.</li> </ul>
Enforce Suite-B 128 bit or more security level Authentication	<p>Configure Suite-B 128 bit or more security level authentication enforcement.</p>
Enforce Suite-B 192 bit or more security level Authentication	<p>Configure Suite-B 192 bit security level authentication enforcement.</p>

**Table 51: 802.1X Authentication Profile WebUI Parameters**

Parameter	Description
Termination	Select the <b>Termination</b> check box to allow 802.1X authentication to terminate on the managed device. This option is disabled by default.
Termination EAP-Type	If you enable termination, click either EAP-PEAP or EAP-TLS to select a Extensible Authentication Protocol (EAP) method.
Termination Inner EAP-Type	If you use EAP-PEAP as the EAP method, specify one of the following inner EAP types: <ul style="list-style-type: none"> <li>• <b>eap-gtc</b>: Described in RFC 2284, this EAP method permits the transfer of unencrypted usernames and passwords from client to server. The main uses for EAP-GTC are one-time token cards such as SecureID and the use of LDAP or RADIUS as the user authentication server. You can also enable caching of user credentials on the managed device as a backup to an external authentication server.</li> <li>• <b>eap-mschapv2</b>: Described in RFC 2759, this EAP method is widely supported by Microsoft clients.</li> </ul>
Token Caching	If you select EAP-GTC as the inner EAP method, you can select the <b>Token Caching</b> check box to enable the managed device to cache the username and password of each authenticated user. The managed device continues to reauthenticate users with the remote authentication server. However, if the authentication server is unavailable, the managed device will inspect its cached credentials to reauthenticate users.  This option is disabled by default.
Token Caching Period	If you select EAP-GTC as the inner EAP method, you can specify the timeout period, in hours, for the cached information. The default value is 24 hours.
CA-Certificate	Click the <b>CA-Certificate</b> drop-down list and select a certificate for client authentication. The CA certificate needs to be loaded in the managed device before it will appear on this list.
Server-Certificate	Click the <b>Server-Certificate</b> drop-down list and select a server certificate the managed device will use to authenticate itself to the client.  <b>NOTE:</b> By default, the <b>default-self-signed</b> certificate is used as server certificate. For more details on <b>default-self-signed</b> certificate, see <a href="#">Managing Certificates on page 776</a> .
TLS Guest Access	Select <b>TLS Guest Access</b> to enable guest access for EAP-TLS users with valid certificates. This option is disabled by default.
TLS Guest Role	Click the <b>TLS Guest Role</b> drop-down list and select the default user role for EAP-TLS guest users. This option may require a license.
Ignore EAPOL-START after authentication	Select <b>Ignore EAPOL-START</b> after authentication to ignore EAPOL-START messages after authentication. This option is disabled by default.

**Table 51: 802.1X Authentication Profile WebUI Parameters**

Parameter	Description
Handle EAPOL-Logoff	Select <b>Handle EAPOL-Logoff</b> to enable handling of EAPOL-LOGOFF messages. This option is disabled by default.
Ignore EAP ID during negotiation	Select <b>Ignore EAP ID during negotiation</b> to ignore EAP IDs during negotiation. This option is disabled by default.
WPA-Fast-Handover	Select this option to enable WPA-fast-handover on phones that support this feature. WAP fast-handover is disabled by default.
Check certificate common name against AAA server	If you use client certificates for user authentication, enable this option to verify that the certificate's common name exists in the server. This parameter is enabled by default in the default-cap and default-rap VPN profiles, and disabled by default on all other VPN profiles.
Disable rekey and reauthentication for clients on call	This feature disables rekey and reauthentication for VoWLAN clients. It is disabled by default, meaning that rekey and reauthentication is enabled. <b>NOTE:</b> This option may require a license

### In the CLI

The following command configures settings for an 802.1X authentication profiles. Individual parameters are described in the previous table.

```
(host) [mynode] (config) # aaa authentication dot1x {<profile>|countermeasures}
```

## Configuring and Using Certificates with AAA FastConnect

The managed device supports 802.1X authentication using digital certificates for AAA FastConnect.

- **Server Certificate**—A server certificate installed in the managed device verifies the authenticity of the managed device for 802.1X authentication. Aruba managed device ship with a demonstration digital certificate. Until you install a customer-specific server certificate in the managed device, this demonstration certificate is used by default for all secure HTTP connections (such as the WebUI and captive portal) and AAA FastConnect. This certificate is included primarily for the purposes of feature demonstration and convenience, and is not intended for long-term use in production networks. Users in a production environment are urged to obtain and install a certificate issued for their site or domain by a well-known certificate authority (CA). You can generate a Certificate Signing Request (CSR) on the managed device to submit to a CA. For information on how to generate a CSR and how to import the CA-signed certificate into the managed device, see [Managing Certificates on page 776](#).
- **Client Certificates**—Client certificates are verified on the managed device (the client certificate must be signed by a known CA) before the username is checked on the authentication server. To use client certificate authentication for AAA FastConnect, you need to import the following certificates into the managed device (see [Importing Certificates on page 779](#)):
  - managed device's server certificate
  - CA certificate for the CA that signed the client certificates

### In the WebUI

1. In a **Managed Network** node hierarchy, navigate to the **Configuration > Authentication > L2 Authentication** page.

2. In the **L2 Authentication** table, select **802.1X Authentication Profile**.
3. Select the **default** 802.1X authentication profile to display configuration parameters.
4. Select the **Termination** check box.
5. In the **Server-Certificate** field, select the server certificate imported into the managed device.
6. In the **CA-Certificate** field, select the CA certificate imported into the managed device.
7. Click **Save As** Enter a name for the 802.1X authentication profile.
8. Enter a name for the new profile in the **Profile Name** field.
9. Click **Pending Changes**.
10. In the **Pending Changes** window, select the check box and click **Deploy changes**.

### In the CLI

```
(host) [mynode] (config) # aaa authentication dot1x <profile>
    termination enable
    server-cert <certificate>
    ca-cert <certificate>
```

## Configuring User and Machine Authentication

When a Windows device boots, it logs onto the network domain using a machine account. Within the domain, the device is authenticated before computer group policies and software settings can be executed; this process is known as *machine authentication*. Machine authentication ensures that only authorized devices are allowed on the network.

You can configure 802.1X for both user and machine authentication (select the **Enforce Machine Authentication** option described in [Table 51](#)). This tightens the authentication process further, since both the device and user need to be authenticated.

## Working with Role Assignment with Machine Authentication Enabled

When you enable machine authentication, there are two additional roles you can define in the 802.1X authentication profile:

- Machine authentication default machine role
- Machine authentication default user role

While you can select the same role for both options, you should define the roles as per the policies that need to be enforced. Also, these roles can be different from the 802.1X authentication default role configured in the AAA profile.

With machine authentication enabled, the assigned role depends upon the success or failure of the machine and user authentications. In certain cases, the role that is ultimately assigned to a client can also depend upon attributes returned by the authentication server or server derivation rules configured on the managed device.

[Table 52](#) describes role assignment based on the results of the machine and user authentications.

**Table 52:** Role Assignment for User and Machine Authentication

Machine Auth Status	User Auth Status	Description	Role Assigned
Failed	Failed	Both machine authentication and user authentication failed. L2 authentication failed.	No role assigned. No access to the network allowed.
Failed	Passed	Machine authentication failed (for example, the machine information is not present on the server) and user authentication succeeded. Server-derived roles do not apply.	Machine authentication default user role configured in the 802.1X authentication profile.
Passed	Failed	Machine authentication succeeded and user authentication has not been initiated. Server-derived roles do not apply.	Machine authentication default machine role configured in the 802.1X authentication profile.
Passed	Passed	Both machine and user are successfully authenticated. If there are server-derived roles, the role assigned via the derivation take precedence. This is the only case where server-derived roles are applied.	A role derived from the authentication server takes precedence. Otherwise, the 802.1X authentication default role configured in the AAA profile is assigned.

For example, if the following roles are configured:

- 802.1X authentication default role (in AAA profile): dot1x\_user
- Machine authentication default machine role (in 802.1X authentication profile): dot1x\_mc
- Machine authentication default user role (in 802.1X authentication profile): guest

Role assignment is as follows:

- If both machine and user authentication succeed, the role is dot1x\_user. If there is a server-derived role, the server-derived role takes precedence.
- If only machine authentication succeeds, the role is dot1x\_mc.
- If only user authentication succeeds, the role is guest.
- On failure of both machine and user authentication, the user does not have access to the network.

With machine authentication enabled, the VLAN to which a client is assigned (and from which the client obtains its IP address) depends upon the success or failure of the machine and user authentications. The VLAN that is ultimately assigned to a client can also depend upon attributes returned by the authentication server or server derivation rules configured on the managed device (see [Understanding VLAN Assignments on page 88](#)). If machine authentication is successful, the client is assigned the VLAN configured in the virtual AP profile. However, the client can be assigned a derived VLAN upon successful user authentication.



You can optionally assign a VLAN as part of a user role configuration. Do not use VLAN derivation if you configure user roles with VLAN assignments.

[Table 53](#) describes VLAN assignment based on the results of the machine and user authentications when VLAN derivation is used.

**Table 53: VLAN Assignment for User and Machine Authentication**

Machine Auth Status	User Auth Status	Description	VLAN Assigned
Failed	Failed	Both machine authentication and user authentication failed. L2 authentication failed.	No VLAN.
Failed	Passed	Machine authentication failed (for example, the machine information is not present on the server) and user authentication succeeded.	VLAN configured in the virtual AP profile.
Passed	Failed	Machine authentication succeeded and user authentication has not been initiated.	VLAN configured in the virtual AP profile.
Passed	Passed	Both machine and user are successfully authenticated.	Derived VLAN. Otherwise, VLAN configured in the virtual AP profile.



The administrator can now associate a VLAN ID to a client data based on the authentication credentials in a bridge mode.

## Enabling 802.1X Supplicant Support on an AP

ArubaOS provides 802.1X supplicant support on the Access Point (AP). The AP can be used as a 802.1X supplicant where access to the wired Ethernet network is restricted to those devices that can authenticate using 802.1X. You can provision an AP to act as an 802.1X supplicant and authenticate to the infrastructure using the PEAP protocol.



Both Campus APs (CAPs) and Remote APs (RAPs) can be provisioned to use 802.1X authentication.

### Prerequisites

- An AP has to be configured with the credentials for 802.1X authentication. These credentials are stored securely in the AP flash.
- The AP must complete the 802.1X authentication before it sends or receives IP traffic such as DHCP.



If the AP cannot complete 802.1X authentication (explicit failure or reply timeout) within 1 minute, the AP will proceed to initiate the IP traffic and attempt to contact the managed device. The infrastructure can be configured to allow this. If the AP contacts the managed device it will be marked as unprovisioned so that the administrator can take corrective action.

### Provisioning an AP as an 802.1X Supplicant

This section describes how an AP can be provisioned as an 802.1X supplicant using CLI or the WebUI.

## In the WebUI

1. In a **Managed Network** node hierarchy, navigate to the **Configuration > Access Points**.
2. Click **Access Points > Provisioning** window. The list of discovered APs are displayed on this page.
3. Select the AP you want to provision.
4. Select the AP to which you want to add new provisioning settings, then click **Provision**. The AP provisioning settings divided into two groups. By default, the ArubaOS WebUI displays only the basic, commonly used configuration settings. The advanced settings are hidden until you click the **Show Advanced** options link.
5. Select the **802.1X Parameters using PEAP**:
  - a. PEAP username: Enter the username of the AP in the **User Name** field.
  - b. PEAP password: Enter the password of the AP in the **Password** field.
6. Enter the password again in the **Retype PEAP password** field and reconfirm it.
7. Click **Submit**.
8. Click **Pending Changes**.
9. In the **Pending Changes** window, select the check box and click **Deploy changes**.

## In the CLI

```
(host) [mynode] (config)# provision-ap
(host) [mynode] (config-submode)# apdot1x-username <username>
(host) [mynode] (config-submode)# apdot1x-passwd <password>
```

To view the 802.1X authentication details on the managed devices:

```
(host) [mynode] # show ap active
```

## Sample Configurations

The following examples show basic configurations:

- [Configuring Authentication with an 802.1X RADIUS Server on page 248](#)
- [Configuring Authentication with the Managed Device's Internal Database on page 259](#)

In the following examples:

- Wireless clients associate to the ESSID **WLAN-01**.
- The following roles allow different networks access capabilities:
  - student
  - faculty
  - guest
  - system administrators

The examples show how to configure using the WebUI and CLI commands.

## Configuring Authentication with an 802.1X RADIUS Server

- An EAP-compliant RADIUS server provides the 802.1X authentication. The RADIUS server administrator must configure the server to support this authentication. The administrator must also configure the server to all communications with the Aruba Mobility Master.
- The authentication type is WPA. From the 802.1X authentication exchange, the client and the Mobility Master derive dynamic keys to encrypt data transmitted on the wireless network.
- 802.1X authentication based on PEAP with MS-CHAPv2 provides both computer and user authentication. If a user attempts to log in without the computer being authenticated first, the user is placed into a more limited "guest" user role.



Windows domain credentials are used for computer authentication, and the user's Windows login and password are used for user authentication. A single user sign-on facilitates both authentication to the wireless network and access to the Windows server resources.



---

[802.1X Configuration for IAS and Windows Clients on page 1062](#) describes how to configure the Microsoft Internet Authentication Server and Windows XP wireless client to operate with the managed device configuration shown in this section.

---

## Configuring Roles and Policies

You can create the following policies and user roles for:

- Student
- Faculty
- Guest
- Sysadmin
- Computer

### Creating the Student Role and Policy

The **student** policy prevents students from using telnet, POP3, FTP, SMTP, SNMP, or SSH to the wired portion of the network. The **student** policy is mapped to the **student** user role.

#### In the WebUI

1. In a **Managed Network** node hierarchy, navigate to the **Configuration > Roles & Policies > Policies** tab.
2. Select + to add the student policy.
3. For Policy Name, enter **student**,
4. Policy Type, select **Session**.
5. Click **Save**.
6. Select the **student** role from the **Policies** table.
7. In the **Policies > student** table, click + to add rules for the policy.
  - a. For **Rule type**, select **Access Control**, then click **OK**.
  - b. For **Source**, select **user**.
  - c. For **Destination**, select **alias**.



---

The following step defines an alias representing all internal network addresses. Once defined, you can use the alias for other rules and policies.

---

- d. Under the **Destination alias** selection, click +. For Destination Name, enter Internal Network. Click + to add a rule. For Rule Type, select **network**. For IP Address, enter 10.0.0.0. For Network Mask/Range, enter 255.0.0.0. Click **Add** to add the network range. Repeat these steps to add the network range 172.16.0.0 - 255.255.0.0. Click **OK**, then click **Submit**. The alias Internal Network appears in the Destination menu. This step defines an alias representing all internal network addresses. Once defined, you can use the alias for other rules and policies.
  - e. Under Destination, select Internal Network.
  - f. Under Service, select **service**. In the Service scrolling list, select **svc-telnet**.
  - g. Under Action, select **drop**.
  - h. Click **Add**.
8. Under Rules, click **Add**.

- a. Under Source, select **user**.
  - b. Under Destination, select **alias** and then select **Internal Network**.
  - c. Under Service, select **service**. In the Service scrolling list, select **svc-pop3**.
  - d. Under Action, select **drop**.
  - e. Click **Add**.
9. Repeat steps 4A-E to create rules for the following services: svc-ftp, svc-smtp, svc-snmp, and svc-ssh.
  10. Click **Save**.
  11. Click **Submit**.
  12. Click the **Roles** tab. Click + to create the student role.
  13. For Role Name, enter **student** then click **Submit**.
  14. Select the role you just created from the **Roles** table.
  15. Select **Show Advanced View**.
  16. In the **Roles > student** table, select the **Policies** tab.
  17. Click + to add a new policy.
  18. Select **Add existing session policy** and select the student policy you previously created. Click **Done**.
  19. Click **Submit**.
  20. Click **Pending Changes**.
  21. In the **Pending Changes** window, select the check box and click **Deploy changes**.

### In the CLI

```
(host) [mynode] (config) #ip access-list session student
    user alias "Internal Network" svc-telnet deny
    user alias "Internal Network" svc-pop3 deny
    user alias "Internal Network" svc-ftp deny
    user alias "Internal Network" svc-smtp deny
    user alias "Internal Network" svc-snmp deny
    user alias "Internal Network" svc-ssh deny
```

```
(host) [mynode] (config) #user-role student
    session-acl student
    session-acl allowall
```

### Creating the Faculty Role and Policy

The **faculty** policy is similar to the **student** policy, however faculty members are allowed to use POP3 and SMTP for VPN remote access from home. (Students are not permitted to use VPN remote access.) The **faculty** policy is mapped to the **faculty** user role.

### In the WebUI

1. In a **Managed Network** node hierarchy, navigate to the **Configuration > Roles & Policies > Policies** tab.
2. Click + to add the faculty policy.
3. For Policy Name, enter **faculty**.
4. For Policy Type, select **Session**.
5. Click **Submit**.
6. Select the new **faculty** policy from the Policies table.
7. Click + in the **Policies > Faculty** table to add rules for the policy.
  - a. Click **Rule Type**, select **Access Control**, then click **OK**.
  - b. Click **Source**, and select **user**.

- c. Click **Destination**, select **alias**, then select **Internal Network**.
  - d. Click **Service/App** and select **service**.
  - e. Click the **Service Alias** drop-down list, and select **svc-telnet**.
  - f. Click **Action**, and select **deny**.
  - g. Click **Save**.
  - h. Repeat steps A-E to create rules for the following services: *svc-ftp*, *svc-snmp*, and *svc-ssh*.
8. Click **Submit**.
  9. Select the **Roles** tab. Click + to create the faculty role.
  10. In the **Name** dialog box, enter **faculty** then click **Submit**.
  11. Select the role you just created from the **Roles** table.
  12. Select **Show Advanced View**.
  13. In the **Roles > faculty** table, select the **Policies** tab.
  14. Click + to add a new policy.
  15. Select **Add existing session policy** and select the faculty policy you previously created. Click **Done**.
  16. Click **Submit**.
  17. Click **Pending Changes**.
  18. In the **Pending Changes** window, select the check box and click **Deploy changes**.

#### In the CLI

```
(host)[mynode](config) #ip access-list session faculty
    user alias "Internal Network" svc-telnet deny
    user alias "Internal Network" svc-ftp deny
    user alias "Internal Network" svc-snmp deny
    user alias "Internal Network" svc-ssh deny
```

```
(host)[mynode](config) #user-role faculty
    session-acl faculty
    session-acl allowall
```

### Creating the Guest Role and Policy

The **guest** policy permits only access to the internet (via HTTP or HTTPS) and only during daytime working hours. The **guest** policy is mapped to the **guest** user role.

#### In the WebUI

1. In a **Managed Network** node hierarchy, navigate to the **Configuration > Roles & Policies > Roles** tab.
2. Select a role name and click + in the **Roles > Roles Names** table.
1. Click + for the **Time range** field and enter the following details:
  - a. For Name, enter **working-hours**.
  - b. For Type, select **Periodic**.
  - c. For **Start day**, click **Weekday**.
  - d. For **Start time(hh:mm)**, enter **07:30**.
  - e. For **End time(hh:mm)**, enter **17:00**.
  - f. Click **OK**.
  - g. Click **Submit**.
2. Click the **Policies** tab. Click + to add the guest policy.
3. For **Policy Name**, enter **guest**.
4. For **Policy Type**, select **Session**.

5. Click **Submit**.
6. Select the Policy name under **Policies**. The **Policies > policy Name** table is displayed.
7. Click + under the **Policies > policy Name** table.
8. Select **Access Control** for the **Rule Type** and click **OK**.
9. Add the following **New Forwarding Rule** information for the policy.
  - To create rules to permit access to DHCP and DNS servers during working hours:
    - a. Under **Source**, select **user**.
    - b. Under **Destination**, select **host**. In Host IP, enter **10.1.1.25**.
    - c. Under **Service**, select **service**. In the Service scrolling list, select **svc-dhcp**.
    - d. Under **Action**, select **permit**.
    - e. Under **Time Range**, select **working-hours**.
    - f. Click **Add**.
    - g. Repeat steps A-F to create a rule for *svc-dns*.
  - To create a rule to deny access to the internal network:
    - a. Under Source, select **user**.
    - b. Under Destination, select **alias**. Select **Internal Network**.
    - c. Under Service, select **any**.
    - d. Under Action, select **drop**.
    - e. Click **Add**.
  - To create rules to permit HTTP and HTTPS access during working hours:
    - a. Under Source, select **user**.
    - b. Under Destination, select **any**.
    - c. Under Service, select service. In the Services scrolling list, select **svc-http**.
    - d. Under Action, select **permit**.
    - e. Under Time Range, select **working-hours**.
    - f. Click **Add**.
    - g. Repeat steps A-F for the *svc-https* service.
  - To create a rule that denies the user access to all destinations and all services:
    - a. Under Source, select **user**.
    - b. Under Destination, select **any**.
    - c. Under Service, select **any**.
    - d. Under Action, select **drop**.
    - e. Click **Add**.
10. Click **Save**.
11. Click **Submit**.
12. Click the **Roles** tab. Click **Add** to create the guest role.
13. For Role Name, enter **guest**.
14. Under **Firewall Policies**, click +. In Choose from Configured Policies, select the guest policy you previously created. Click **Done**.
15. Click **Pending Changes**.
16. In the **Pending Changes** window, select the check box and click **Deploy changes**.

## In the CLI

```
time-range working-hours periodic
  weekday 07:30 to 17:00
```

```
(host)[mynode](config) #ip access-list session guest
  user host 10.1.1.25 svc-dhcp permit time-range working-hours
  user host 10.1.1.25 svc-dns permit time-range working-hours
  user alias "Internal Network" any deny
  user any svc-http permit time-range working-hours
  user any svc-https permit time-range working-hours
  user any any deny
```

```
(host)[mynode](config) #user-role guest
  session-acl guest
```

## Creating Roles and Policies for Sysadmin and Computer

The **allowall** policy, a predefined policy, allows unrestricted access to the network. The **allowall** policy is mapped to both the **sysadmin** user role and the **computer** user role.

### In the WebUI

1. In a **Managed Network** node hierarchy, navigate to **Configuration > Roles & Policies > Roles** tab. Click **+** to create the sysadmin role.
2. For Role Name, enter **sysadmin** and click **Submit**.
3. Under the **Roles > Sysadmin** table, click **Show Advanced View**.
4. Under Policies, Click **+**. In **Add Policy**, select the **Add existing session policy** and select the predefined **allowall** policy from the **Policy Name** drop-down list.
5. Click **Submit**.
6. Click **Pending Changes**.
7. In the **Pending Changes** window, select the check box and click **Deploy changes**.

### In the CLI

```
(host)[mynode](config) #user-role sysadmin
  session-acl allowall
```

## Creating a computer role

### In the WebUI

1. In a **Managed Network** node hierarchy, navigate to **Configuration > Roles & Policies > Roles** tab. Click **+** to create the sysadmin role.
2. For Role Name, enter **computer** and click **Submit**.
3. Under the **Roles > computer** table, click **Show Advanced View**.
4. Under Policies, Click **+**. In **Add Policy**, select the **Add existing session policy** and select the predefined **allowall** policy from the **Policy Name** drop-down list.
5. Click **Submit**.
6. Click **Pending Changes**.
7. In the **Pending Changes** window, select the check box and click **Deploy changes**.

### In the CLI

Use the following command to create a computer role:

```
(host)[mynode](config) #user-role computer
  session-acl allowall
```

## Creating an Alias for the Internal Network

### In the CLI

```
(host) [MyNode] (config) #netdestination "Internal Network"  
network 10.0.0.0 255.0.0.0  
network 172.16.0.0 255.255.0.0
```

## Configuring the RADIUS Authentication Server

Configure the RADIUS server IAS1, with IP address 10.1.1.21 and shared key. The RADIUS server is configured to send an attribute called Class to the managed device; the value of this attribute is set to either "student," "faculty," or "sysadmin" to identify the user's group. The managed device uses the literal value of this attribute to determine the role name.

On the managed device, you add the configured server (IAS1) into a server group. For the server group, you configure the server rule that allows the Class attribute returned by the server to set the user role.

### In the WebUI

1. In a **Managed Network** node hierarchy, navigate to the **Configuration > Authentication > Auth Servers** page.
2. In the **All Servers** list, click +.
  - a. In the New Server window, enter **IAS1** for the server name
  - b. Enter **10.1.1.21** for the server IP address.
  - c. Click the **Type** drop-down list and select the **RADIUS** server type.
  - d. Click **Submit**.
3. Select the new server from the All Servers list.
4. In the **Shared Key** field, enter a key, such as |\*a^t%183923!|. (You must enter the key string twice.)
5. Click **Submit**.
6. In the Server Group list, click +.
  - a. Select the server group **IAS** to display configuration parameters for the server group.
  - b. In the **Server Group > IAS** table, click +.
  - c. Select **Add existing server**, select IAS1, then click **Submit**.
8. In the Server Groups table, select the IAS server group. The **Server Group > IAS** table appears.
9. In the **Server Group > IAS** table, select **Server Rules**.
10. Click + to add a new server rule.
  - a. For Condition, enter **Class**.
  - b. For Attribute, select **value-of** from the drop-down list.
  - c. For Operand, select **set role**.
  - d. Click **Add**.
11. Click **Submit**.
12. Click **Pending Changes**.
13. In the **Pending Changes** window, select the check box and click **Deploy changes**.

### In the CLI

```
[host] [mynode] (config) #aaa authentication-server radius IAS1  
host 10.1.1.21  
key |*a^t%183923!
```

```
[host] [mynode] (config) #aaa server-group IAS
    auth-server IAS1
    set role condition Class value-of
```

## Configuring 802.1X Authentication

An AAA profile specifies the 802.1X authentication profile and 802.1X server group to be used for authenticating clients for a WLAN. The AAA profile also specifies the default user roles for 802.1X and MAC authentication.

In the 802.1X authentication profile, configure enforcement of machine authentication before user authentication. If a user attempts to log in before machine authentication completes, the user is placed in the limited guest role.

### In the WebUI

1. In a **Managed Network** node hierarchy, navigate to the **Configuration > Authentication > L2 Authentication** page.
2. Select **802.1X Authentication Profile**.
  - a. Select the Profile name.
  - b. Select **Enforce Machine Authentication**.
  - c. For the **Machine Authentication: Default Machine Role**, select **computer**.
  - d. For the **Machine Authentication: Default User Role**, select **guest**.
  - e. Click **Save**.
3. In the **Configuration > Authentication > AAA Profiles** tab.
  - a. In the AAA Profiles, click **+** to add a new profile.
  - b. Enter **aaa\_dot1x** as the **Profile Name** and then click **Save**.
  - a. Select the profile name you just added.
  - b. For **MAC Authentication Default Role**, select **computer**.
  - c. For **802.1X Authentication Default Role**, select **faculty**.
  - d. Click **Save**.
4. In the **Profiles** list (under the **aaa\_dot1x** profile), select **802.1X Authentication Profile**.
  - a. From the drop-down list, select the **dot1x** 802.1X authentication profile you configured previously.
  - b. Click **Save**.
5. In the **Profiles** list (under the **aaa\_dot1x** profile), select **802.1X Authentication Server Group**.
  - a. From the drop-down list, select the IAS server group you created previously.
  - b. Click **Save**.
6. Click **Pending Changes**.
7. In the **Pending Changes** window, select the check box and click **Deploy changes**.

### In the CLI

```
(host) [mynode] (config) #aaa authentication dot1x dot1x
    machine-authentication enable
    machine-authentication machine-default-role computer
    machine-authentication user-default-role guest

(host) [mynode] (config) #aaa profile aaa_dot1x
    d>ot1x-default-role faculty
    mac-default-role computer
    authentication-dot1x dot1x
    d>ot1x-server-group IAS
```

## Configuring VLANs

In this example, wireless clients are assigned to either VLAN 60 or 61 while guest users are assigned to VLAN 63. VLANs 60 and 61 split users into smaller IP subnetworks, improving performance by decreasing broadcast traffic. The VLANs are internal to the Aruba managed device only and do not extend into other parts of the wired network. The clients' default gateway is the Aruba managed device, which routes traffic out to the 10.1.1.0 subnetwork.

You configure the VLANs, assign IP addresses to each VLAN, and establish the "helper address" to which client DHCP requests are forwarded.

### In the WebUI

1. In a **Managed Network** node hierarchy, navigate to the **Configuration > Interfaces > VLANs** page. Click **+** to add **VLAN\_60**.
  - a. For **VLAN ID**, enter **60**.
  - b. Click **Submit**.
  - c. Repeat steps A and B to add VLANs 61 and 63.
2. To configure IP parameters for the VLANs, navigate to the **Configuration > Interfaces > VLANs** page.
  - a. Select **VLAN\_60**.
  - b. Under **VLANs > VLAN\_60** table, select the VLAN ID, **60**. Click **IPv4**.
  - c. For IP Address, enter **10.1.60.1**.
  - d. For Net Mask, enter **255.255.255.0**.
  - e. Under DHCP Helper Address, click **Add**. Enter **10.1.1.25** and click **Add**.
  - f. Click **Submit**.
3. Similarly, for VLAN 61, navigate to the **Configuration > Interfaces > VLANs** page.
  - a. Select **VLAN\_61**.
  - b. Under **VLANs > VLAN\_61** table, select the VLAN ID, 61. Click **IPv4**.
  - c. For IP Address, enter **10.1.61.1**.
  - d. For Net Mask, enter **255.255.255.0**.
  - e. Under DHCP Helper Address, click **Add**. Enter **10.1.1.25** and click **Add**.
  - f. Click **Submit**.
4. Similarly, for VLAN 63, navigate to the **Configuration > Interfaces > VLANs** page.
  - a. Select **VLAN\_63**.
  - b. Under **VLANs > VLAN\_63** table, select the VLAN ID, 61. Click **IPv4**.
    - a. For IP Address, enter **10.1.63.1**.
    - b. For Net Mask, enter **255.255.255.0**.
    - c. Under DHCP Helper Address, click **Add**. Enter **10.1.1.25** and click **Add**.
    - d. Click **Submit**.
5. Select the **IP Routes** tab.
  - a. For Default Gateway, enter **10.1.1.254**.
  - b. Click **Submit**.

### In the CLI

```
(host) [mynode] (config) #vlan 60
(host) [mynode] (config) #interface vlan 60
ip address 10.1.60.1 255.255.255.0
ip helper-address 10.1.1.25
```



```

(host) [mynode] (config) #vlan 61
(host) [mynode] (config) #interface vlan 61
    ip address 10.1.61.1 255.255.255.0
    ip helper-address 10.1.1.25

(host) [mynode] (config) #vlan 63
(host) [mynode] (config) #interface vlan 63
    ip address 10.1.63.1 255.255.255.0
    ip helper-address 10.1.1.25

(host) [mynode] (config) #ip default-gateway 10.1.1.254

```

## Configuring the WLANs

In this example, default AP parameters for the entire network are: the default ESSID is WLAN-01 and the encryption mode is TKIP. A second ESSID called “guest” has the encryption mode set to static WEP with a configured WEP key.

In this example, the non-guest clients that associate to an AP are mapped into one of two different user VLANs. The initial AP to which the client associates determines the VLAN: clients that associate to APs in the first floor of the building are mapped to VLAN 60, and clients that associate to APs in the second floor of the building are mapped to VLAN 61. Therefore, the APs in the network are segregated into two AP groups, named first-floor and second-floor. (See [Creating an AP group on page 500](#) for information about creating AP groups.) The guest clients are mapped into VLAN 63.

## Configuring the Guest WLAN

You create and configure the virtual AP profile, guest and apply the profile to each AP group. The “guest” virtual AP profile contains the SSID profile “guest” which configures static WEP with a WEP key.

### In the WebUI

1. In a **Managed Network** node hierarchy, navigate to the **Configuration > System > Profiles** page.
2. Under **All Profiles**, select **Wireless LAN** and then **Virtual AP**.
3. To create the guest virtual AP:
  - a. Click **+** to add a new Virtual AP Profile under **Virtual AP profile: New Profile** tab.
  - a. Enter **guest** for the profile name field and click **Save**.
  - b. Under **All Profiles**, select **Wireless LAN** and then **SSID**.
  - c. For the name for the SSID profile, enter **guest**.
  - d. For the **Network Name** for the SSID, enter **guest**.
  - e. For **Network Authentication**, select **None**.
  - f. For **Encryption**, select **WEP**.
  - g. Enter the WEP Key.
  - h. Click **Save** to apply the SSID profile to the Virtual AP.
  - i. Under **Profile Details**, click **Save**.
4. Click on the **guest** virtual AP name in the **Profiles** list or in **Profile Details** to display configuration parameters.
  - a. Ensure that you select **Virtual AP enable**.
  - b. For **VLAN**, select **63**.
  - c. Click **Submit**.
5. In the **Configuration > Wireless > AP Configuration** page.

6. In the AP Group list, click **Edit** for the second-floor.
7. In the **Profiles** list, select **Wireless LAN** and then **Virtual AP**.
8. Select **guest** from the **Add a profile** drop-down list. Click **Add**.
9. Click **Submit**.
10. Click **Pending Changes**.
11. In the **Pending Changes** window, select the check box and click **Deploy changes**.

### In the CLI

```
(host)v(config) #wlan ssid-profile guest
      essid guest
      wepkey1 aaaaaaaaaa
      opmode static-wep

(host)[mynode](config) #wlan virtual-ap guest
      vlan 63
      ssid-profile guest

(host)[mynode](config) #ap-group first-floor
      virtual-ap guest
(host)(config) #ap-group second-floor
      virtual-ap guest
```

## Configuring the Non-Guest WLANs

You create and configure the SSID profile “WLAN-01” with the ESSID “WLAN-01” and WPA TKIP encryption. You need to create and configure two virtual AP profiles: one with VLAN 60 for the first-floor AP group and the other with VLAN 61 for the second-floor AP group. Each virtual AP profile references the SSID profile “WLAN-01” and the previously-configured AAA profile `aaa_dot1x`.

### In the WebUI

1. In a **Managed Network** node hierarchy, navigate to the **Configuration > AP Group**.
2. In the **AP Group** list, select an AP Group **first-floor**.
3. Click + under **WLAN** for the AP Group selected.
4. Select WLAN-01 for the Virtual AP.
5. In the **Configuration > System > Profiles** tab. In the **Profiles** list, select **Wireless LAN** and then **Virtual AP**.
6. In a **Managed Network** node hierarchy, navigate to configure the WLAN-01\_first-floor virtual AP:
  - a. Select **NEW** from the Add a profile drop-down list. Enter **WLAN-01\_first-floor**, and click **Add**.
  - b. In the **Profile Details** entry for the WLAN-01\_first-floor virtual AP profile, select the **aaa\_dot1x** AAA profile you previously configured. A pop-up window displays the configured AAA profile parameters. Click **Save**.
  - c. From the SSID profile drop-down list, select **NEW**. A pop-up window allows you to configure the SSID profile.
  - d. Enter **WLAN-01** for the name of the SSID profile.
  - e. For **Network Name**, enter **WLAN-01**.
  - f. For **Network Authentication**, select **WPA**.
  - g. Click **Save**.
  - h. At the bottom of the **Profile Details** page, click **Save**.
7. Click on the WLAN-01\_first-floor virtual AP name in the **Profiles** list or in **Profile Details** to display configuration parameters.

- a. Ensure that you select **Virtual AP enable**.
  - b. For **VLAN**, select 60.
  - c. Click **Save**.
8. In a **Managed Network** node hierarchy, navigate to the **Configuration > AP Group** page.
  9. In the **AP Group** list, select an AP Group **second-floor**.
  10. Click + under **WLAN** for the AP Group selected.
  11. Select WLAN-01 for the Virtual AP.
  12. To configure the WLAN-01\_second-floor virtual AP:
    - a. Select **NEW** from the **Add a profile** drop-down list. Enter **WLAN-second-floor**, and click **Add**.
    - b. In the Profile Details entry for the virtual AP profile, select **aaa\_dot1x** from the **AAA profile** drop-down list. A pop-up window displays the configured AAA profile parameters. Click **Save**.
    - c. From the SSID profile drop-down list, select **WLAN-01**. A pop-up window displays the configured SSID profile parameters. Click **Submit**.
    - d. At the bottom of the **Profile Details** page, click **Save**.
  13. Click on the new virtual AP name in the **Profiles** list or in **Profile Details** to display configuration parameters.
    - a. Ensure that you select **Virtual AP enable**.
    - b. For **VLAN**, select 61.
    - c. Click **Save**.

## In the CLI

```
(host) [mynode] (config) #wlan ssid-profile WLAN-01
    essid WLAN-01
    opmode wpa-tkip

(host) [mynode] (config) #wlan virtual-ap WLAN-01_first-floor
    vlan 60
    aaa-profile aaa_dot1x
    ssid-profile WLAN-01

(host) [mynode] (config) #wlan virtual-ap WLAN-01_second-floor
    vlan 61
    aaa-profile aaa_dot1x
    ssid-profile WLAN-01

(host) [mynode] (config) #ap-group first-floor
    virtual-ap WLAN-01_first-floor
    ap-group second-floor
    virtual-ap WLAN-01_second-floor
```

## Configuring Authentication with the Managed Device's Internal Database

In the following example:

- The managed device's internal database provides user authentication.
- The authentication type is WPA. From the 802.1X authentication exchange, the client and the managed device derive dynamic keys to encrypt data transmitted on the wireless network.

## Configuring the Internal Database

Configure the internal database with the username, password, and role (student, faculty, or sysadmin) for each user. There is a default **internal** server group that includes the internal database. For the internal server

group, configure a server derivation rule that assigns the role to the authenticated client.

### In the WebUI

1. In a **Managed Network** node hierarchy, navigate to the **Configuration > Authentication > Auth Servers** page.
2. In the **All Servers** list, select **Internal**.
3. Select a server name under **Server>Internal** table
4. For each user, enter a username and password.
5. Select a role for each user (if a role is not specified, the default role is guest).
6. Select the expiration time for the user account in the internal database.
7. Click **Submit**.
8. Click **Pending Changes**.
9. In the **Pending Changes** window, select the check box and click **Deploy changes**.

### In the CLI



---

Use the privileged mode in the CLI to configure users in the managed device's internal database.

---

```
(host) [mynode] (config) #local-userdb add username <user> password <password>
```

## Configuring a Server Rule

### In the WebUI

1. In a **Managed Network** node hierarchy, navigate to the **Configuration > Authentication > Auth Servers** page.
2. Select **Server Group** to display the Server Group list.
3. Select the **internal** server group from the **Server Group** table.
4. Click **Server Rules** tab in the **Server Group > Internal** table.
5. Click + to add a server derivation rule.
  - a. For **Attribute**, enter Role.
  - b. Select **value-of** from the **Operations** drop-down list.
  - c. Select **Set Role** from the **Action** drop-down list.
  - d. Click **Add**.
6. Click **Submit**.
7. Click **Pending Changes**.
8. In the **Pending Changes** window, select the check box and click **Deploy changes**.

### In the CLI

```
(host) [mynode] (config) #aaa server-group internal
    set role condition Role value-of
```

## Configuring 802.1X Authentication

An AAA profile specifies the 802.1X authentication profile and 802.1X server group to be used for authenticating clients for a WLAN. The AAA profile also specifies the default user role for 802.1X authentication.

For this example, you enable both 802.1X authentication and termination on the managed device.

## In the WebUI

1. In a **Managed Network** node hierarchy, navigate to the **Configuration > Authentication > L2 Authentication** page. In the profiles list, select **802.1X Authentication Profile**.
  - a. In the **Instance** list, enter **dot1x**, then click **Add**.
  - b. Select the dot1x profile you just created.
  - c. Select **Termination**.



---

The defaults for EAP Method and Inner EAP Method are EAP-PEAP and EAP-MSCHAPv2, respectively.

---

- d. Click **Submit**.
2. Select the **AAA Profiles** tab.
    - a. In the **AAA Profiles Summary**, click **Add** to add a new profile.
    - b. Enter **aaa\_dot1x**, then click **Add**.
    - c. Select the aaa\_dot1x profile you just created.
    - d. For 802.1X Authentication Default Role, select **faculty**.
    - e. Click **Save**.
  3. In the **Profiles** list (under the aaa\_dot1x profile you just created), select **802.1X Authentication Profile**.
    - a. Select the dot1x profile from the **802.1X Authentication Profile** drop-down list.
    - b. Click **Save**.
  4. In the **Profiles** list (under the aaa\_dot1x profile you just created), select **802.1X Authentication Server Group**.
    - a. Select the **internal** server group.
    - b. Click **Save**.

## In the CLI

```
(host) [mynode] (config) #aaa authentication dot1x dot1x
    termination enable
```

```
(host) [mynode] (config) #aaa profile aaa_dot1x
    d>ot1x-default-role student
    authentication-dot1x dot1x
    d>ot1x-server-group internal
```

## Configuring VLANs

In this example, wireless clients are assigned to either VLAN 60 or 61 while guest users are assigned to VLAN 63. VLANs 60 and 61 split users into smaller IP subnetworks, improving performance by decreasing broadcast traffic. The VLANs are internal to the Aruba managed device only and do not extend into other parts of the wired network. The clients' default gateway is the Aruba managed device, which routes traffic out to the 10.1.1.0 subnetwork.

You configure the VLANs, assign IP addresses to each VLAN, and establish the "helper address" to which client DHCP requests are forwarded.

## In the WebUI

1. In a **Managed Network** node hierarchy, navigate to the **Configuration > Interfaces > VLANs** page. Click **+** to add VLAN\_60.
  - a. For **VLAN ID**, enter **60**.
  - b. Click **Submit**.

- c. Repeat steps A and B to add VLANs 61 and 63.
2. To configure IP parameters for the VLANs, navigate to the **Configuration > Interfaces > VLANs** page.
  - a. Select **VLAN\_60**.
  - b. Under **VLANs > VLAN\_60** table, select the VLAN ID, 60. Click **IPv4**.
  - c. For IP Address, enter **10.1.60.1**.
  - d. For Net Mask, enter **255.255.255.0**.
  - e. Under DHCP Helper Address, click **Add**. Enter **10.1.1.25** and click **Add**.
  - f. Click **Submit**.
3. To configure IP parameters for the VLANs, navigate to the **Configuration > Interfaces > VLANs** page.
  - a. Select **VLAN\_61**.
  - b. Under **VLANs > VLAN\_61** table, select the VLAN ID, 61. Click **IPv4**.
    - a. For IP Address, enter **10.1.61.1**.
    - b. For Net Mask, enter **255.255.255.0**.
    - c. Under DHCP Helper Address, click **Add**. Enter **10.1.1.25** and click **Add**.
    - d. Click **Submit**.
4. To configure IP parameters for the VLANs, navigate to the **Configuration > Interfaces > VLANs** page.
  - a. Select **VLAN\_63**.
  - b. Under **VLANs > VLAN\_63** table, select the VLAN ID, 63. Click **IPv4**.
    - a. For IP Address, enter **10.1.63.1**.
    - b. For Net Mask, enter **255.255.255.0**.
    - c. Under DHCP Helper Address, click **Add**. Enter **10.1.1.25** and click **Add**.
    - d. Click **Submit**.
5. Select the **IP Routes** tab.
  - a. For Default Gateway, enter **10.1.1.254**.
  - b. Click **Submit**.
6. Click **Pending Changes**.
7. In the **Pending Changes** window, select the check box and click **Deploy changes**.

### In the CLI

```
(host) [mynode] (config) #vlan 60
(host) [mynode] (config) #interface vlan 60
    ip address 10.1.60.1 255.255.255.0
    ip helper-address 10.1.1.25

(host) [mynode] (config) #vlan 61
(host) [mynode] (config) #interface vlan 61
    ip address 10.1.61.1 255.255.255.0
    ip helper-address 10.1.1.25

(host) [mynode] (config) #vlan 63
(host) [mynode] (config) #interface vlan 63
    ip address 10.1.63.1 255.255.255.0
    ip helper-address 10.1.1.25

(host) [mynode] (config) #ip default-gateway 10.1.1.254
```

## Configuring WLANs

In this example, default AP parameters for the entire network are as follows: the default ESSID is WLAN-01 and the encryption mode is TKIP. A second ESSID called guest has the encryption mode set to static WEP with a configured WEP key.

In this example, the non-guest clients that associate to an AP are mapped into one of two different user VLANs. The initial AP to which the client associates determines the VLAN: clients that associate to APs in the first floor of the building are mapped to VLAN 60, and clients that associate to APs in the second floor of the building are mapped to VLAN 61. Therefore, the APs in the network are segregated into two AP groups, named first-floor and second-floor. (See [Creating an AP group on page 500](#) for information about creating AP groups.) The guest clients are mapped into VLAN 63.

## Configuring the Guest WLAN

You create and configure the virtual AP profile, guest and apply the profile to each AP group. The guest virtual AP profile contains the SSID profile, guest which configures static WEP with a WEP key.

### In the WebUI

1. In a **Managed Network** node hierarchy, navigate to the **Configuration > Wireless > AP Configuration** page.
2. In the **AP Group** list, select **first-floor**.
3. In the **Profiles** list, select **Wireless LAN** and then **Virtual AP**.
4. To configure the guest virtual AP:
  - a. Select **NEW** from the **Add a profile** drop-down list. Enter **guest** for the name of the virtual AP profile, and click **Add**.
  - b. In the **Profile Details** entry for the guest virtual AP profile, select **NEW** from the SSID profile drop-down list. A pop-up window allows you to configure the SSID profile.
  - c. Enter **guest** for the name of the SSID profile.
  - d. Enter **guest** for the Network Name.
  - e. For Network Authentication, select **None**.
  - f. For Encryption, select **WEP**.
  - g. Enter the WEP key.
  - h. Click **Save**.
  - i. Under **Profile Details**, click **Save**.
5. Click on the guest virtual AP name in the **Profiles** list or in **Profile Details** to display configuration parameters.
  - a. Ensure that you select **Virtual AP enable**.
  - b. For **VLAN**, select **63**.
  - c. Click **Save**.
6. In a **Managed Network** node hierarchy, navigate to the **Configuration > Wireless > AP Configuration** page.
7. In the **AP Group** list, select **second-floor**.
8. In the **Profiles** list, select **Wireless LAN** and then **Virtual AP**.
9. Select **guest** from the **Add a profile** drop-down list. Click **Add**.
10. Click **Submit**.
11. Click **Pending Changes**.
12. In the **Pending Changes** window, select the check box and click **Deploy changes**.

## In the CLI

```
(host) [mynode] (config) #wlan ssid-profile guest
    essid guest
    wepkey1 aaaaaaaaaa
    opmode static-wep

(host) [mynode] (config) #wlan virtual-ap guest
    vlan 63
    ssid-profile guest

(host) [mynode] (config) #ap-group first-floor
    virtual-ap guest
(host) [mynode] (config) #ap-group second-floor
    virtual-ap guest
```

## Configuring the Non-Guest WLANs

You create and configure the SSID profile “WLAN-01” with the ESSID “WLAN-01” and WPA TKIP encryption. You need to create and configure two virtual AP profiles: one with VLAN 60 for the first-floor AP group and the other with VLAN 61 for the second-floor AP group. Each virtual AP profile references the SSID profile “WLAN-01” and the previously-configured AAA profile “aaa\_dot1x”.

## In the WebUI

1. In a **Managed Network** node hierarchy, navigate to the **Configuration > Wireless > AP Configuration** page.
2. In the AP Group list, select first-floor.
3. In the Profiles list, select Wireless LAN, then select Virtual AP.
4. To configure the WLAN-01\_first-floor virtual AP:
  - a. Select **NEW** from the Add a profile drop-down list. Enter **WLAN-01\_first-floor**, and click **Add**.
  - b. In the **Profile Details** entry for the WLAN-01\_first-floor virtual AP profile, select **aaa\_dot1x** from the **AAA Profile** drop-down list. A pop-up window displays the configured AAA parameters. Click **Save**.
  - c. From the SSID profile drop-down list, select **NEW**. A pop-up window allows you to configure the SSID profile.
  - d. Enter **WLAN-01** for the name of the SSID profile.
  - e. Enter **WLAN-01** for the Network Name.
  - f. Select **WPA** for Network Authentication.
  - g. Click **Save**.
  - h. At the bottom of the **Profile Details** page, click **Save**.
5. Click on the WLAN-01\_first-floor virtual AP profile name in the **Profiles** list or in **Profile Details** to display configuration parameters.
  - a. Ensure that you select **Virtual AP enable**.
  - b. For VLAN, select 60.
  - c. Click **Save**.
6. In a **Managed Network** node hierarchy, navigate to the **Configuration > Wireless > AP Configuration** page.
7. In the **AP Group** list, select second-floor.
8. In the **Profiles** list, select **Wireless LAN** and then **Virtual AP**.
9. To create the WLAN-01\_second-floor virtual AP:
  - a. Select **NEW** from the Add a profile drop-down list. Enter **WLAN-01\_second-floor**, and click **Add**.



- b. In the **Profile Details** entry for the virtual AP profile, select **aaa\_dot1x** from the **AAA Profile** drop-down list. A pop-up window displays the configured AAA profile parameters. Click **Save**.
  - c. From the **SSID profile** drop-down list, select **WLAN-01**. A pop-up window displays the configured SSID profile parameters. Click **Save**.
  - d. At the bottom of the **Profile Details** page, click **Save**.
10. Click on the WLAN-01\_second-floor virtual AP profile name in the **Profiles** list or in **Profile Details** to display the configuration parameters.
    - a. Ensure that you select **Virtual AP enable**.
    - b. For **VLAN**, select 61.
    - c. Click **Save**.
  11. Click **Submit**.
  12. Click **Pending Changes**.
  13. In the **Pending Changes** window, select the check box and click **Deploy changes**.

### In the CLI

```
(host) [mynode] (config) #wlan ssid-profile WLAN-01
    essid WLAN-01
    opmode wpa-tkip

(host) [mynode] (config) #wlan virtual-ap WLAN-01_first-floor
    vlan 60
    aaa-profile aaa_dot1x
    ssid-profile WLAN-01

(host) [mynode] (config) #wlan virtual-ap WLAN-01_second-floor
    vlan 61
    aaa-profile aaa_dot1x
    sid-profile WLAN-01

(host) [mynode] (config) #ap-group first-floor
    virtual-ap WLAN-01_first-floor
(host) [mynode] (config) #ap-group second-floor
    virtual-ap WLAN-01_second-floor
```

## Configuring Mixed Authentication Modes

Use `l2-auth-fail-through` command to perform mixed authentication which includes both MAC and 802.1X authentication. When MAC authentication fails, enable the `l2-auth-fail-through` command to perform 802.1X authentication.




---

By default the `l2-auth-fail-through` command is disabled.

---

**Table 54:** *Mixed Authentication Modes*

Authentication	1	2	3	4	5	6
MAC authentication	Success	Success	Success	Fail	Fail	Fail
802.1X authentication	Success	Fail	—	Success	Fail	—
Association	dynamic-wep	No Association	static-wep	dynamic-wep	No Association	static-wep
Role Assignment	802.1X	—	MAC	802.1X	—	logon

[Table 54](#) describes the different authentication possibilities

### In the CLI

```
(host) [mynode] (config) #aaa profile test  
12-auth-fail-through
```

## Performing Advanced Configuration Options for 802.1X

This section describes advanced configuration options for 802.1X authentication.

### Configuring Reauthentication with Unicast Key Rotation

When enabled, unicast and multicast keys are updated after each reauthorization. It is a best practice to configure the time intervals for reauthentication, multicast key rotation, and unicast key rotation to be at least 15 minutes. Ensure that these intervals are mutually prime, and the factor of the unicast key rotation interval and the multicast key rotation interval is less than the reauthentication interval.



---

Unicast key rotation depends upon both the AP/managed device and wireless client behavior. It is known that some wireless NICs have issues with unicast key rotation.

---

The following is an example of the parameters you can configure for reauthentication with unicast and multicast key rotation:

- Reauthentication: Enabled
- Reauthentication Time Interval: 6011 Seconds
- Multicast Key Rotation: Enabled
- Multicast Key Rotation Time Interval: 1867 Seconds
- Unicast Key Rotation: Enabled
- Unicast Key Rotation Time Interval: 1021 Seconds

### In the WebUI

1. In a **Managed Network** node hierarchy, navigate to the **Configuration > Authentication**. Select the **L2 Authentication** tab.
2. Select 802.1X Authentication Profile, then select the name of the profile you want to configure.
3. Enter the following values:

- Reauthentication Interval: 6011
  - Multicast Key Rotation Time Interval: 1867
  - Unicast Key Rotation Time Interval: 1021
  - Multicast Key Rotation: (select)
  - Unicast Key Rotation: (select)
  - Reauthentication: (select)
4. Click **Submit**.
  5. Click **Pending Changes**.
  6. In the **Pending Changes** window, select the check box and click **Deploy changes**.

### In the CLI

```
(host) [mynode] (config) #aaa authentication dot1x profile
reauthentication
timer reauth-period 6011
unicast-keyrotation
timer ukey-rotation-period 1021
multicast-keyrotation
timer mkey-rotation-period 1867
```

## Application Single Sign-On Using L2 Authentication

This feature allows single sign-on (SSO) for different web-based applications using Layer 2 authentication information. Single sign-on for web-based application uses Security Assertion Markup Language (SAML), which happens between the web service provider and an identity provider (IDP) that the web server trusts. A request made from the client to a web server is redirected to the IDP for authentication. If the user has already been authenticated using L2 credentials, the IDP server already knows the authentication details and returns a SAML response, redirecting the client browser to the web-based application. The user enters the web-based application without needing to enter the credentials again.

Enabling application SSO using L2 network information requires configuration on the managed device and on the IDP server. The Aruba ClearPass Policy Manager is the only IDP supported. The managed device has been optimized to work with ClearPass Policy Manager to provide better functionality as an IDP.

### Important Points to Remember

- ClearPass Policy Manager is the only supported IDP.
- SSO occurs after 802.1X authentication. Therefore, SSO after captive portal authentication is not supported. Roles for captive portal and SSO are mutually exclusive and, therefore, a user in the captive portal role cannot perform SSO and vice-versa.
- SSO with VIA is not supported.
- There is a limit on the number of concurrent sessions that can be serviced at a given instant. This limit is set at the webserver level using the **web-server profile web-max-clients** command. The default value is 320 for 7000 Series and 7200 Series managed device platforms and 25 for other managed device platforms. The maximum number of concurrent SSO sessions that can be handled is dependent on the other web services being handled and the same time.

### Enabling Application SSO

Enabling application SSO using L2 authentication information requires configuration on the managed device and ClearPass Policy Manager. This feature is enabled by completing the following steps:

- ClearPass Policy Manager (refer to the ClearPass Policy Manager for configuration of the following procedures):
  - Add the managed device's IP address as a network device
  - Add the user to the local user DB
  - Create an enforcement profile to return the Aruba vendor-specific attribute (VSA) SSO token
  - Create an IDP attribute enforcement profile
  - Create an enforcement policy binding the Aruba VSA SSO token enforcement profile
  - Create an enforcement policy binding the IDP enforcement profile
  - Create a service, allowing the respective authentication types and authentication database, and bind the Aruba VSA SSO token enforcement policy.
  - Create a service, allowing the respective authentication types and authentication database, and bind the IDP enforcement policy.
  - Configure SSO for the ClearPass Policy Manager.
- Managed device:
  - Configuring an SSO-IDP Profile
  - Applying an SSO Profile to a User Role
  - Selecting an IDP Certificate

## Configuring SSO IDP-Profiles on the Managed devices

Before SSO can be enabled, you must configure an SSO profile by completing the procedure detailed below.

### In the WebUI

1. In a **Managed Network** node hierarchy, navigate to the **Configuration > System**. Click the **Profiles** tab.
2. Expand the **Wireless LAN** menu.
3. Select **SSO**.
4. Click **+** to create a new profile.
5. Enter a name in the **Profile Name** dialog box.
6. Click **+** to add a new URL.
7. Enter the name of the URL in the **URL Name** dialog box.
8. Enter the URL into the **URL** text box.
9. Click **OK**.
10. Repeat steps 4 through 8 for each URL you are adding to the SSO profile.
11. Click **Save** when all URLs have been added.
12. Click **Submit**.
13. Click **Pending Changes**.
14. In the **Pending Changes** window, select the check box and click **Deploy changes**.

### In the CLI

```
(host) [mynode] (config) #sso idp-profile <idp profile name>
#idp <urlname> <url>
```

## Applying an SSO Profile to a User Role

The newly created SSO profile must be applied to any applicable user rules that require SSO. Apply the SSO profile by completing the steps below.

## In the WebUI

1. In a **Managed Network** node hierarchy, navigate to **Configuration > Roles & Policies > Roles**
2. In the **Roles** table, select the User Role that the SSO profile will be linked to.
3. Click **Show Advanced View**.
4. Click the **More** Tab.
5. Select **Authentication**.
6. Click the **IDP profile** drop-down list and select an IDP profile.
7. Click **Save**.
8. Click **Submit**.
9. Click **Pending Changes**.
10. In the **Pending Changes** window, select the check box and click **Deploy changes**.

## In the CLI

```
(host) [mynode](config)# user-role <role name>
(host) [mynode](config)# sso <idp profile name>
```

## Selecting an IDP Certificate

An SSL certificate is needed for SSL negotiation with browser. The certificate can be imported in PKCS12 format, so that it contains the certificate and private key, or the key pair can be generated and a certificate signing request (CSR) request sent to the enterprise CA server to generate a certificate which can then be uploaded to the managed device.

For information about uploading or generating a certificate, see [Managing Certificates](#).

After a certificate is uploaded or generated, the IDP certificate must be selected.

## In the WebUI

1. In a **Managed Network** node hierarchy, navigate to the **Configuration > System > More** tab.
2. Click **General**
3. Under **IDP Server Certificate**, select the IDP certificate from the **IDP Server Certificate** drop-down list.



---

By default, the **default-self-signed** certificate is used as the server certificate. For more details on **default-self-signed** certificate, see [Managing Certificates on page 776](#).

---

4. Click **Submit**.
5. Click **Pending Changes**.
6. In the **Pending Changes** window, select the check box and click **Deploy changes**.

## In the CLI

```
(host) [mynode](config)# web-server profile
(host) [mynode](Web Server Configuration) # idp-cert <name of the certificate>
```

## Device Name as User Name for Non-802.1X Authentication

When a client is authenticated by non-802.1X method of authentication, the host name of the host device is used as the user name (instead of the MAC address) of the host device. When a device tries to obtain an IP address by using DHCP, the host name of the host device in the option-12 field of DHCP request is used as the host name of the device.

A CLI command allows the use of host name or MAC address of a device as the user name of the host device. By default, the MAC address of the host device is used as the user name. If the CLI command is enabled, the host name of the host device is used as the user name.

## Using Device Name as User Name

In the CLI:

```
(host) [mm] (config) #aaa profile <profile>  
(host) [mm] (AAA Profile "<profile >") #username-from-dhcp-opt12
```

Mobility Master supports stateful 802.1X authentication, stateful NTLM authentication, and authentication for Wireless Internet Service Provider roaming (WISPr). Stateful authentication differs from 802.1X authentication in that Mobility Master does not manage the authentication process directly, but instead monitors the authentication messages between a user and an external authentication server, then assigns a role to that user based upon the information in those authentication messages. WISPr authentication allows clients to roam between hotspots using different ISPs.

This chapter describes the following topics:

- [Working With Stateful Authentication on page 271](#)
- [Working With WISPr Authentication on page 272](#)
- [Understanding Stateful Authentication Best Practices on page 272](#)
- [Configuring Stateful 802.1X Authentication on page 272](#)
- [Configuring Stateful NTLM Authentication on page 274](#)
- [Configuring Stateful Kerberos Authentication on page 275](#)
- [Configuring WISPr Authentication on page 276](#)

## Working With Stateful Authentication

Mobility Master supports three different types of stateful authentication:

- **Stateful 802.1X authentication:** This feature allows Mobility Master to learn the identity and role of a user connected to a third-party AP, and is useful for authenticating users to networks with APs from multiple vendors. When an 802.1X-capable access point sends an authentication request to a RADIUS server, Mobility Master inspects this request and the associated response to learn the authentication state of the user. It then applies an identity-based user-role through the Policy Enforcement Firewall.
- **Stateful Kerberos authentication:** Stateful Kerberos authentication configures Mobility Master to monitor the Kerberos authentication messages between a client and a Windows authentication server. If the client successfully authenticates via a Kerberos authentication server, Mobility Master recognizes that the client has been authenticated and assigns that client a specified user role.
- **Stateful NTLM authentication:** NT LAN Manager (NTLM) is a suite of Microsoft authentication and session security protocols. You can configure Mobility Master to monitor the NTLM authentication messages between a client and a Windows authentication server. If the client successfully authenticates via an NTLM authentication server, Mobility Master recognizes that the client has been authenticated and assigns that client a specified user-role.

The default Windows authentication method has changed from the older NTLM protocol to the newer Kerberos protocol, starting with Windows 2000. Therefore, stateful NTLM authentication is most useful for networks with legacy, pre-Windows 2000 clients. Also note that unlike other types of authentication, all users authenticated via stateful NTLM authentication must be assigned to the user-role specified in the Stateful NTLM Authentication profile. Aruba's stateful NTLM authentication does not support placing users in various roles based upon group membership or other role-derivation attributes.

## Working With WISPr Authentication

WISPr authentication allows a “smart client” to authenticate to the network when roaming between Wireless Internet Service Providers, even if the wireless hotspot uses an ISP, which the client may not have an account for.

If you are a hotspot operator using WISPr authentication, and a client that has an account with your ISP attempts to access the Internet at your hotspot, your ISP's WISPr AAA server authenticates that client directly and allows the client to access the network. If, however, the client only has an account with a *partner* ISP, your ISP's WISPr AAA server forwards that client's credentials to the partner ISP's WISPr AAA server for authentication. Once the client has been authenticated on the partner ISP, it is authenticated on your hotspot's own ISP, as per their service agreements. After your ISP sends an authentication message to Mobility Master, the default WISPr user-role is assigned to that client.

Mobility Master supports the following smart clients, which enable client authentication and roaming between hotspots by embedding iPass Generic Interface Specification (GIS) *redirect*, *proxy*, *authentication*, and *logoff* messages within HTML messages:

- iPass
- Boingo
- Trustive
- weRoam
- AT&T

## Understanding Stateful Authentication Best Practices

Before you can configure a stateful authentication feature, you must define the user-role you want to assign to the authenticated users and create a server group, which includes a RADIUS authentication server for stateful 802.1X authentication or a Windows server for stateful NTLM authentication. For details on performing these tasks, refer to the following sections of this User Guide:

- [Roles and Policies on page 367](#)
- [Configuring a RADIUS Server on page 182](#)
- [Configuring a Windows Server on page 190](#)
- [Configuring Server Groups on page 191](#)

You can use the default stateful NTLM authentication and WISPr authentication profiles to manage the settings for these features, or you can create additional profiles as desired. Unlike most other types of authentication, stateful 802.1X authentication uses only a single Stateful 802.1X profile. This profile can be enabled or disabled, but you cannot configure more than one Stateful 802.1X profile.

## Configuring Stateful 802.1X Authentication

When configuring 802.1X authentication for clients on non-Aruba APs, you must specify the group of RADIUS servers that performs user authentication and assign roles to users who successfully complete authentication. When the user logs off or shuts down the client machine, Mobility Master notes the deauthentication message from the RADIUS server and changes the user's role from the specified authenticated role back to the login role. For details on defining a RADIUS server used for stateful 802.1X authentication, see [Configuring a RADIUS Server on page 182](#).

### In the WebUI

To configure the Stateful 802.1X Authentication profile via the WebUI:



1. In the **Managed Network** node hierarchy, navigate to the **Configuration > Authentication** page.
2. Under the **L2 Authentication** tab, select **Stateful 802.1X Authentication**.
3. Select the role assigned to stateful 802.1X authenticated users from the **Default Role** drop-down list.
4. Specify the timeout period for authentication requests, between 1 and 20 seconds. The default value is 10 seconds.
5. Select the **Mode** check box to enable stateful 802.1X authentication.
6. Click **Save**.
7. Select **Pending Changes**.
8. In the **Pending Changes** window, select the check box and click **Deploy changes**.

## In the CLI

Use the commands below to configure stateful 802.1X authentication via the command-line interface. The first set of commands defines the RADIUS server used for 802.1X authentication, and the second set assigns that server to a server group. The third set associates the server group with the stateful 802.1X authentication profile, then sets the authentication role and timeout period.

```
(host) [md] (config) #aaa authentication-server radius <rad-server-name>
  acctport <acctport>
  authport <authport>
  clone <source>
  enable
  enable-ipv6
  enable-radsec
  host <host>
  key <key>
  nas-identifier <nas-identifier>
  nas-ip <nas-ip>
  retransmit <retransmit>
  timeout <timeout>
  use-ip-for-calling-station
  use-md5

(host) [md] (config) #aaa server-group <sg_name>

  allow-fail-through
  auth-server <name> [match-authstring {contains <sub_string>|equals <sub_string>|starts-with
  <sub_string>} [match-fqdn {all|<fqdn>}] [position <prio>] [trim-fqdn]
  clone <source>
  load-balance
  set {role|vlan} condition <attribute> [contains <operand>|ends-with <operand>|equals
  <operand>|not-equals <operand>|starts-with <operand>] [value-of] [set-value <set-value-str>]
  [position <number>]

(host) [md] (config) #aaa authentication stateful-dot1x
  default-role <default-role>
  enable
  server-group <srv-group>
  timeout <timeout>
```

Use the commands below to view the servers and profiles configured for stateful 802.1X authentication:

```
(host) [md] #show aaa authentication-server radius

(host) [md] #show aaa server-group

(host) [md] #show aaa authentication stateful-dot1x
```

## Configuring Stateful NTLM Authentication

The Stateful NTLM Authentication profile requires that you specify a server group, which includes the servers performing NTLM authentication and the role to be assigned to users who are successfully authenticated. For details on defining a windows server used for NTLM authentication, see [Configuring a Windows Server on page 190](#).

When a user logs off or shuts down the client machine, the user remains in the authenticated role until the user ages out, meaning there is no user traffic for the amount of time specified in the **User idle timeout** setting under **Configuration > Authentication > Advanced > Authentication Timers**.

### In the WebUI

To configure a stateful NTLM authentication profile via the WebUI:

1. In the **Managed Network** node hierarchy, navigate to the **Configuration > Authentication** page.
2. Select **Stateful NTLM Authentication** from the **L3 Authentication** tab.
3. Under **Stateful NTLM Authentication Profile: New Profile**, click the **Add** button to add a new profile entry. To modify an existing stateful NTLM authentication profile, select a profile entry below **Stateful NTLM Authentication** in the **L3 Authentication** list.
4. Enter a profile name.
5. From the **Default Role** drop-down list, select the role to be assigned to all users after completing stateful NTLM authentication.
6. Select the **Mode** check box to enable stateful NTLM authentication.
7. Specify the timeout period for authentication requests, between 1 and 20 seconds. The default value is 10 seconds.
8. Click **Save**.
9. In the **L3 Authentication** list, select the **Server Group** entry below the stateful NTLM authentication profile.
10. Select the group of Windows servers to be used for stateful NTLM authentication from the **Server Group** drop-down list.
11. To enable authentication fail through and load balancing, select the check boxes for **Fail Through** and **Load Balance**.
12. Click **Save**.
13. Select **Pending Changes**.
14. In the **Pending Changes** window, select the check box and click **Deploy changes**.

### In the CLI

Use the commands below to configure stateful NTLM authentication via the command-line interface. The first set of commands defines the Windows server used for NTLM authentication, and the second set adds that server to a server group. The third set associates that server group with the stateful NTLM authentication profile, then defines the profile settings.

```
(host) [md] (config) #aaa authentication-server windows <windows_server_name>
  clone <source>
  domain <domain>
  enable
  host <host>
```

```
(host) [md] (config) #aaa server-group <sg_name>
  allow-fail-through
  auth-server <name> [match-authstring {contains <sub_string>|equals <sub_string>|starts-with
  <sub_string>} [match-fqdn {all|<fqdn>}] [position <prio>] [trim-fqdn]
```

```

clone <source>
load-balance
set {role|vlan} condition <attribute> [contains <operand>|ends-with <operand>|equals
<operand>|not-equals <operand>|starts-with <operand>] [value-of] [set-value <set-value-str>]
[position <number>]

(host) [md] (config) #aaa authentication stateful-ntlm <profile-name>
clone <source>
default-role <default-role>
enable
server-group <server-group>
timeout <timeout>

```

Use the commands below to view the servers and profiles configured for stateful NTLM authentication:

```

(host) [md] #show aaa authentication-server window

(host) [md] #show aaa server-group

(host) [md] #show aaa authentication stateful-ntlm

```

## Configuring Stateful Kerberos Authentication

The Stateful Kerberos Authentication profile requires that you specify a server group, which includes the Kerberos servers and the role assigned to authenticated users. For details on defining a windows server used for Kerberos authentication, see [Configuring a Windows Server on page 190](#).

When the user logs off or shuts down the client machine, the user remains in the authenticated role until the user ages out, meaning there is no user traffic for the amount of time specified in the **User idle timeout** setting under **Configuration > Authentication > Advanced > Authentication Timers**.

### In the WebUI

To configure a stateful Kerberos authentication profile via the WebUI:

1. In the **Managed Network** node hierarchy, navigate to the **Configuration > Authentication** page.
2. Select **Stateful Kerberos Authentication** from the **L3 Authentication** tab.
3. Under **Stateful Kerberos Authentication Profile: New Profile**, click the **Add** button to add a new profile entry. To modify an existing stateful Kerberos authentication profile, select a profile entry below **Stateful Kerberos Authentication** in the **L3 Authentication** list.
4. Enter a profile name.
5. From the **Default Role** drop-down list, select the role to be assigned to all users after completing stateful Kerberos authentication.
6. Specify the timeout period for authentication requests, between 1 and 20 seconds. The default value is 10 seconds.
7. Click **Save**.
8. In the **All Profiles** list, select the **Server Group** entry below the stateful Kerberos authentication profile.
9. Select the group of Windows servers to be used for stateful Kerberos authentication from the **Server Group** drop-down list.
10. To enable authentication fail through and load balancing, select the check boxes for **Fail Through** and **Load Balance**.
11. Click **Save**.
12. Select **Pending Changes**.
13. In the **Pending Changes** window, select the check box and click **Deploy changes**.

## In the CLI

Use the commands below to configure stateful Kerberos authentication via the command-line interface. The first set of commands defines the server used for Kerberos authentication, and the second set adds that server to a server group, and the third set of commands associates that server group with the stateful NTLM authentication profile then defines the profile settings.

```
(host) [md] (config) #aaa authentication-server windows <windows_server_name>
  clone <source>
  domain <domain>
  enable
  host <host>

(host) [md] (config) #aaa server-group <sg_name>
  allow-fail-through
  auth-server <name> [match-authstring {contains <sub_string>|equals <sub_string>|starts-with
<sub_string>} [match-fqdn {all|<fqdn>}] [position <prio>] [trim-fqdn]
  clone <source>
  load-balance
  set {role|vlan} condition <attribute> [contains <operand>|ends-with <operand>|equals
<operand>|not-equals <operand>|starts-with <operand>] [value-of] [set-value <set-value-str>]
[position <number>]

(host) [md] (config) #aaa authentication stateful-kerberos <profile-name>
  clone <source>
  default-role <default-role>
  server-group <server-group>
  timeout <timeout>
```

Use the commands below to view the servers and profiles configured for stateful Kerberos authentication:

```
(host) [md] #show aaa authentication-server windows

(host) [md] #show aaa server-group

(host) [md] #show aaa authentication stateful-kerberos
```

## Configuring WISPr Authentication

The WISPr authentication profile includes parameters to define RADIUS attributes, default roles for authenticated WISPr users, the maximum number of authentication failures, and login wait times. The WISPr-Location-ID, sent from Mobility Master to the WISPr RADIUS server, is the concatenation of the ISO Country Code, E.164 Country Code, E.164 Area Code, and SSID/Zone parameters configured in this profile.

The parameters used to define WISPr RADIUS attributes are specific to the RADIUS server your ISP uses for WISPr authentication; contact your ISP to determine these values. You can find a list of ISO and ITU country and area codes at the ISO and ITU websites ([www.iso.org](http://www.iso.org)) and (<http://www.itu.int>).

## In the WebUI

To configure a WISPr authentication profile in the WebUI:

1. In the **Managed Network** node hierarchy, navigate to the **Configuration > Authentication** page.
2. Select **WISPr Authentication** from the **L3 Authentication** tab.
3. Under **WISPr Authentication Profile: New Profile**, click the **Add** button to add a new profile entry. To modify an existing WISPr authentication profile, select a profile entry below **WISPr Authentication** in the **All Profiles** list.
4. Enter a profile name.
5. Define values for the following parameters:

**Table 55: WISPr Authentication Profile Parameters**

Parameter	Description
Default Role	Default role assigned to users that complete WISPr authentication.
Max Authentication failures	Maximum number of failed WISPr authentication attempts permitted for each user.
User Agent String	User agent that identifies and provides details on the browser used during an HTTP request
Logon wait minimum wait	If the controller's CPU utilization has surpassed the <b>Login wait CPU utilization threshold value</b> , the <b>Logon wait minimum wait</b> parameter defines the minimum number of seconds a user has to wait to retry a login attempt. Range: 1–10 seconds. Default: 5 seconds.
Logon wait maximum wait	If the controller's CPU utilization has surpassed the <b>Login wait CPU utilization threshold</b> value, the <b>Logon wait maximum wait</b> parameter defines the maximum number of seconds a user has to wait to retry a login attempt. Range: 1–10 seconds. Default: 10 seconds.
Logon wait CPU utilization threshold	Percentage of CPU utilization at which the maximum and minimum login wait times are enforced. Range: 1–100%. Default: 60%.
WISPr Location-ID ISO Country Code	The ISO Country Code section of the WISPr Location ID.
WISPr Location-ID E.164 Country Code	The E.164 Country Code section of the WISPr Location ID.
WISPr Location-ID E.164 Area Code	The E.164 Area Code section of the WISPr Location ID.
WISPr Location-ID SSID/Zone	The SSID/Zone section of the WISPr Location ID.
WISPr Operator Name	Name identifying the hotspot operator.
WISPr Location Name	Name identifying the hotspot location. If no name is defined, the parameter uses the name of the associated AP.

6. Click **Save**.
7. In the **All Profiles** list, select the **Server Group** entry below the WISPR authentication profile.
8. Select the group of RADIUS servers to be used for WISPr authentication from the **Server Group** drop-down list.
9. To enable authentication fail through and load balancing, select the check boxes for **Fail Through** and **Load Balance**.
10. Click **Save**.
11. Select **Pending Changes**.
12. In the **Pending Changes** window, select the check box and click **Deploy changes**.



---

A Boingo smart client uses a NAS identifier in the format <CarrierID>\_<VenueID> for location identification. To support Boingo clients, you must also configure the NAS identifier parameter in the Radius server profile for the WISPr server

---

## In the CLI

Use the CLI commands below to configure WISPr authentication. The first set of commands defines the RADIUS server used for WISPr authentication, and the second set adds that server to a server group. The third set of commands associates that server group with the WISPR authentication profile, then defines the profile settings.

```
(host) [md] (config) #aaa authentication-server radius <rad-server-name>
  acctport <acctport>
  authport <authport>
  clone <source>
  enable
  enable-ipv6
  enable-radsec
  host <host>
  key <key>
  nas-identifier <nas-identifier>
  nas-ip <nas-ip>
  retransmit <retransmit>
  timeout <timeout>
  use-ip-for-calling-station
  use-md5

(host) [md] (config) #aaa server-group <sg_name>

  allow-fail-through
  auth-server <name> [match-authstring {contains <sub_string>|equals <sub_string>|starts-with
  <sub_string>} [match-fqdn {all|<fqdn>}] [position <prio>] [trim-fqdn]
  clone <source>
  load-balance
  set {role|vlan} condition <attribute> [contains <operand>|ends-with <operand>|equals
  <operand>|not-equals <operand>|starts-with <operand>] [value-of] [set-value <set-value-str>]
  [position <number>]

(host) [md] (config) #aaa authentication wispr <profile-name>
  agent_string <agent_string>
  clone <source>
  default-role <default-role>
  logon-wait {cpu-threshold <cpu-threshold>|maximum-delay <maximum-delay>|minimum-delay
  <minimum-delay>}
  max-authentication-failures <max-authentication-failures>
  server-group <server-group>
  wispr-location-id-ac <wispr-location-id-ac>
  wispr-location-id-cc <wispr-location-id-cc>
  wispr-location-id-isocc <wispr-location-id-isocc>
  wispr-location-id-network <wispr-location-id-network>
  wispr-location-name-location <wispr-location-name-location>
  wispr-location-name-operator-name <wispr-location-name-operator-name>
```

User the commands below to view the servers and profiles configured for WISPr authentication:

```
(host) [md] #show aaa authentication-server radius

(host) [md] #show aaa server-group

(host) [md] #show aaa authentication wispr
```

The Certificate Revocation feature enables the Mobility Master or the Managed Device to perform real-time certificate revocation checks using the Online Certificate Status Protocol (OCSP), or traditional certificate validation using the Certificate Revocation List (CRL) client.

Topics in this chapter include:

- [Understanding OCSP and CRL on page 279](#)
- [Configuring the Mobility Master or Managed Device as an OCSP Client on page 280](#)
- [Configuring the Mobility Master or Managed Device as a CRL Client on page 281](#)
- [Configuring the Mobility Master or Managed Device as a CRL Client](#)
- [Certificate Revocation Checking for SSH Pubkey Authentication on page 283](#)

## Understanding OCSP and CRL

OCSP (RFC 2560) is a standard protocol that consists of an OCSP client and an OCSP responder. This protocol determines revocation status of a given digital public-key certificate without downloading the entire CRL.

CRL is the traditional method of checking certificate validity. A CRL provides a list of certificate serial numbers that have been revoked or are no longer valid. CRLs let the verifier check the revocation status of the presented certificate while verifying it. CRLs are limited to 512 entries.

Both the Delegated Trust Model and the Direct Trust Model are supported to verify digitally signed OCSP responses. Unlike the Direct Trust Model, the Delegated Trust Model does not require the OCSP responder certificates to be explicitly available on the Mobility Master or the managed device.

## Configuring the Mobility Master or the Managed Device as OCSP and CRL Clients

The Mobility Master or the managed device can act as an OCSP client and issue OCSP queries to remote OCSP responders located on the intranet or Internet. Since many applications in ArubaOS (such as IKE), use digital certificates, a protocol such as OCSP needs to be implemented for revocation.

An entity that relies on the content of a certificate (a relying party) needs to check before accepting the certificate as valid. Once it is verified that the certificate has not been revoked, the OCSP client retrieves certificate revocation status from an OCSP responder. The responder may be the CA (Certificate Authority) that has issued the certificate in question, or it may be some other designated entity which provides the service on behalf of the CA. A *revocation checkpoint* is a logical profile that is tied to each CA certificate that the Mobility Master or the managed device has (trusted or intermediate). Also, the user can specify revocation preferences within each profile.

The OCSP request is not signed by the Aruba OCSP client at this time. However, the OCSP response is always signed by the responder.

Both OCSP and CRL configuration and administration is usually performed by the administrator who manages the web access policy for an organization.

In small networks where there is no Internet connection or connection to an OCSP responder, CRL is preferable to than OCSP.

## Configuring the Mobility Master or Managed Device as an OCSP Responder

The Mobility Master or the managed device can be configured to act as an OCSP responder (server) and respond to OCSP queries from clients that want to obtain revocation status of certificates.

The OCSP responder on the Mobility Master or the managed device is accessible over HTTP port 8084. You cannot configure this port. Although the OCSP responder accepts signed OCSP requests, it does not attempt to verify the signature before processing the request. Therefore, even unsigned OCSP requests are supported.

The Mobility Master or the managed device as an OCSP responder provides revocation status information to Aruba applications that use CRLs. This is useful in small disconnected networks where clients cannot reach outside OCSP server to validate certificates. Typical scenarios include client to client or client to other server communication situations where the certificates of either party need to be validated.

## Configuring the Mobility Master or Managed Device as an OCSP Client

When OCSP is used as the revocation method, you need to configure the OCSP responder certificate and the OCSP URL.

### In the WebUI

1. In the **Mobility Master** node hierarchy, navigate to **Configuration > System > Certificates**.
2. Expand the **Import Certificates** accordion menu.
3. Click the + icon in the **Import Certificates** section.
4. Enter the following certificate details in the **New Certificate** section:
  - a. Enter a name in the **Certificate name** text box. This name identifies the certificate you are importing.
  - b. Enter the certificate filename in the **Certificate filename** text box. Click the **Browse** button to enter the full pathname.
  - c. Enter a password in the **Optional passphrase** text box. The password is optional.
  - d. If you opted to use the optional password (in step c), re-enter the password in the **Retype passphrase** text box.
  - e. Select a certificate format from the **Certificate format** drop-down list. You can import certificates of format DER, P12, PEM, PFX, PKCS12, and PKCS7.
  - f. Select **OCSPResponderCert** from the **Certificate type** drop-down list.



---

A revocation check method (OCSP or CRL) can be chosen independently for every revocation checkpoint. In this example, we are only describing the OCSP check method.

---

When this certificate is imported, it is maintained in the certificate store for OCSP responder certificates. These certificates are used for signature verification.

5. Click **Submit**. The certificate appears in the **Import Certificates** section.
6. For detailed information about an imported certificate, click the certificate from the certificate list.
7. Click the **Revocation Checkpoint** accordion menu.
8. In the **Revocation Checkpoint** section, click the record for which you want to configure the revocation checkpoint. The **Revocation Checkpoint** section is displayed.
  - a. In the **Revocation Check** list, select **ocsp** from the **Method 1** drop-down list as the primary check method.
  - b. In the **OCSP URL** text box, enter the URL of the OCSP responder.



- c. Select the OCSF certificate that you want to configure from the **OCSF Responder Cert** drop-down list.
9. Click **Submit**.
10. Click **Pending Changes**.
11. In the **Pending Changes** window, select the check box indicating the pending change and click **Deploy Changes**.

## In the CLI

This example configures an OCSF client with the revocation check method as OCSF for a revocation checkpoint.

The OCSF responder certificate is configured first. The corresponding OCSF responder service is available at <http://10.4.46.202/ocsp>. The check method is OCSF for the revocation checkpoint.

```
(host) [mynode] (config) #crypto-local pki rcp <name>
(host) [mynode] (config-submode) #ocsp-responder-cert <ocsp_responder_cert>>
(host) [mynode] (config-submode) #ocsp-url http://10.4.46.202/ocsp
(host) [mynode] (config-submode) #revocation-check ocsp
```

The **show crypto-local pki OCSFResponderCert** command lists the contents of the OCSF Responder Certificate store.

The **show crypto-local pki rcp <rcp\_name>** command shows the entire configuration for a given revocation checkpoint.

## Configuring the Mobility Master or Managed Device as a CRL Client

CRL is the traditional method of checking certificate validity. When you want to check certificate validity using a CRL, import the CRL. You can import CRLs only through the WebUI.

### In the WebUI

To configure the Mobility Master as a CRL client, perform the following steps:

1. In the **Mobility Master** node hierarchy, navigate to **Configuration > System > Certificates**.
2. Expand the **Import Certificates** accordion menu.
3. Click the + icon in the **Import Certificates** section.
4. Enter the following certificate details in the **New Certificate** section:
  - a. Enter a name in the **Certificate name** text box. This name identifies the certificate you are importing.
  - b. Enter the certificate filename in the **Certificate filename** text box. Click the **Browse** button to enter the full pathname.
  - c. Enter a password in the **Optional passphrase** text box. The password is optional.
  - d. If you opted for using the optional password (in step c), re-enter the password in the **Retype passphrase** text box.
  - e. Select a certificate format from the **Certificate format** drop-down list. You can import certificates of format DER, P12, PEM, PFX, PKCS12, and PKCS7.
  - f. Select **CRL** from the **Certificate type** drop-down list.




---

A revocation check method (OCSF or CRL) can be chosen independently for every revocation checkpoint. In this example, we are only describing the CRL check method.

---

When this CRL is imported, it is maintained in the store for CRLs. These CRLs are used for signature verification.

5. Click **Submit**. The CRL appears in the **Import Certificates** section.
6. For detailed information about an imported CRL, click the CRL from the CRL list.
7. Click the **Revocation Checkpoint** accordion menu.
  - a. In the **Revocation Checkpoint** section, click the record for which you want to configure the revocation checkpoint. The **Revocation Checkpoint** section is displayed.
  - b. In the **Revocation Check** list, select **crl** from the **Method 1** drop-down list.
  - c. In the **CRL Location** text box, enter the CRL you want to use for this revocation checkpoint. The CRLs listed are files that have already been imported onto the Mobility Master or the managed device.
8. Click **Submit**.
9. Click **Pending Changes**.
10. In the **Pending Changes** window, select the check box indicating the pending change and click **Deploy Changes**.

## In the CLI

This example configures an OCSP responder with the check method as CRL for a revocation check point.

```
(host) [mynode] (config) #crypto-local pki rcp <rcp-name>
(host) [mynode] (config-submode) #crl-location file <filename>
(host) [mynode] (config-submode) #revocation-check crl
```

## Configuring the Mobility Master or Managed Device as an OCSP Responder

When configured as an OCSP responder, the Mobility Master or the managed device provides revocation status information to ArubaOS applications that use CRLs.

## In the WebUI

Perform the following steps to configure the Mobility Master as an OCSP responder:

1. In the **Mobility Master** node hierarchy, navigate to **Configuration > System > Certificates**.
2. Expand the **Import Certificates** accordion menu.
3. Click the + icon in the **Import Certificates** section.
4. Enter the following certificate details in the **New Certificate** section:
  - a. Enter a name in the **Certificate name** text box. This name identifies the certificate you are importing.
  - b. Enter the certificate filename in the **Certificate filename** text box. Click the **Browse** button to enter the full pathname.
  - c. Enter a password in the **Optional passphrase** text box. The password is optional.
  - d. If you opted for using the optional password (in step c), re-enter the password in the **Retype passphrase** text box.
  - e. Select a certificate format from the **Certificate format** drop-down list. You can import certificates of format DER, P12, PEM, PFX, PKCS12, and PKCS7.
  - f. Select **OCSPSignerCert** from the **Certificate type** drop-down list.

When this certificate is imported, it is maintained in the certificate store for OCSP signer certificates. These certificates are used for signature verification.

The OCSF signer cert signs OCSF responses for this revocation checkpoint. The OCSF signer cert can be the same trusted CA as the checkpoint, a designated OCSF signer certificate issued by the same CA as the checkpoint or some other local trusted authority.

If you do not specify an OCSF signer cert, OCSF responses are signed using the global OCSF signer certificate. If that is not present, than an error message is sent out to clients.



---

The OCSF signer certificate takes precedence over the global OCSF signer certificate as it is checkpoint specific.

---

5. Click **Submit**. The certificate appears in the **Import Certificates** section.
6. For detailed information about an imported certificate, click the certificate from the certificate list.
7. Click the **Revocation Checkpoint** accordion menu.
  - a. Select **Enabled** from the **Enable OCSF Responder** drop-down list.

**Enable OCSF Responder** is a global option that turns the OCSF responder service on or off on the Mobility Master or the managed device. The default is disabled (off). Enabling this option automatically adds the OCSF responder port (TCP 8084) to the permit list in the CP firewall so this can be accessed from outside the Mobility Master or the managed device.
  - b. Select the **OCSFSignerCert** to be used to sign OCSF responses for this revocation checkpoint from the **OCSF Certificates** drop-down list .
  - c. In the **Revocation Checkpoint** section, click the record for which you want to configure the revocation checkpoint. The **Revocation Checkpoint** section is displayed.
  - d. In the **Revocation Check** list, select **ocsp** from the **Method 1** drop-down list as the primary check method. Optionally, select a backup check method from the **Method 2** drop-down list.
  - e. Select **Enabled** from the **Enable OCSF Responder** drop-down list.
  - f. Select **OCSFSignerCert** from the **OCSF Signer Cert** drop-down list.
  - g. In the **CRL Location** text box, enter the CRL you want used for this revocation checkpoint. The CRLs listed are files that have already been imported onto the Mobility Master or the managed device.
8. Click **Submit**.
9. Click **Pending Changes**.
10. In the **Pending Changes** window, select the check box indicating the pending change and click **Deploy Changes**.

## In the CLI

This example configures the Mobility Master or the managed device as an OCSF responder.

```
(host) [mynode] (config) #crypto-local pki service-ocsp-responder
(host) [mynode] (config) #crypto-local pki rcp <name>
(host) [mynode] (config-submode) #ocsp-signer-cert oscsp_CA1
(host) [mynode] (config-submode) #crl-location file <filename>
(host) [mynode] (config-submode) #enable-ocsp-responder
```

## Certificate Revocation Checking for SSH Pubkey Authentication

This feature allows the ssh-pubkey management user to be optionally configured with a Revocation Checkpoint (RCP). This meets the requirement for a two-factor authentication and integration of device management with PKI for SSH pubkey authentication. The ArubaOS implementation of SSH using Pubkey authentication is designed for integration with smart cards or other technologies that use X.509 certificates.

The RCP checks the revocation status of the SSH user's client certificate before permitting access. If the revocation check fails, the user is denied access using the ssh-pubkey authentication method. However, the user can still authenticate through a username and password if configured to do so.

For information about configuring a revocation checkpoint, see [Certificate Revocation](#).

## Configuring the SSH Pubkey User with RCP

You can configure the SSH pubkey user with RCP to check the validity of the user's X.509 certificate.

### In the WebUI

To configure the SSH Pubkey User with RCP using the WebUI, perform the following steps:

1. In the **Mobility Master** node hierarchy, navigate to **Configuration > System > Admin**.
2. Click the **Management User** accordion menu.
3. Click the **Show users with certificate authentication** link. The **Management Users with Certificate Authentication** section is displayed.
4. In the **Management Users with Certificate Authentication** section, click the + icon. The **Management Users with Certificate Authentication > New User** section is displayed.
5. In the **Management Users with Certificate Authentication > New User** section, perform the following steps:
  - a. Enter a username in the **Username** text box.
  - b. Select the **Webui certificate** check box if you want the user to get the Webui authentication.
  - c. Select a role from the **Role** drop-down list.
  - d. Select a certificate from the **Trusted CA certificate name** drop-down list.
  - e. Enter the client certificate serial number in the **Client certificate serial no.** text box.
  - f. Select the **Use external authentication server to authenticate** check box, if you want the user to be authenticated by an external authentication server.
  - g. Select the **SSH public key** check box. When you select this check box, the other applicable options such as Role, Client certificate, and Revocation checkpoint are displayed.
  - h. Select a client certificate from the **Client certificate** drop-down list.
6. To specify the revocation checkpoint, perform either of the following tasks :
  - To enable the RCP check, select a valid configured RCP from **Revocation checkpoint** drop-down list.
  - Select **None** if you do not want the RCP check enabled for the SSH pubkey user.
7. Click **Submit**.
8. Click **Pending Changes** at the top of the window.
9. In the **Pending Changes** window, select the check box indicating the pending change and click **Deploy Changes**.

### In the CLI

The CLI allows you to configure an optional RCP for an ssh-pubkey user. Users can still be configured without the RCP. In this example, the certificate name is

"client1-rg", the username is "test1," the role name is "root," and the rcp is "ca-rg:"

```
(host) [mynode] (config) #mgmt-user ssh-pubkey client-cert client1-rg test1 root rcp ca-rg
```

In this example, a user is configured without the RCP:

```
(host) [mynode] (config) #mgmt-user ssh-pubkey client-cert client2-rg test2 root
```

## Displaying Revocation Checkpoint for the SSH Pubkey User

The RCP checks the revocation status of the SSH user's client certificate before permitting access. If the revocation check fails, the user is denied access using the ssh-pubkey authentication method. However, the user can still authenticate through a username and password if configured to do so. This feature allows the ssh-pubkey management user to be optionally configured with a Revocation Checkpoint (RCP). This meets the requirement for a two-factor authentication and integration of device management with PKI for SSH pubkey authentication. The ArubaOS implementation of SSH using Pubkey authentication is designed for integration with smart cards or other technologies that use X.509.

The column **REVOCATION CHECKPOINT** displays the configured RCP for the ssh-pubkey user. If no RCP is configured for the user, the entry **none** is displayed.

### In the WebUI

To view the revocation checkpoint for an SSH pubkey user, perform the following steps:

1. In the **Mobility Master** node hierarchy, navigate to **Configuration > System > Admin**.
2. Click the **Management User** accordion menu.
3. Click the **Show users with certificate authentication** link. The **Management Users with Certificate Authentication** section is displayed.
4. Click the user name for which you want to know the configured RCP. The **Management User > <username>** section is displayed.
5. The **Revocation Checkpoint** column displays the RCP configured (if any) for the SSH pubkey user.

### In the CLI

Execute the following command from the Mobility Master node hierarchy:

```
(host) [mynode] #show mgmt-user ssh-pubkey
```

## Removing the SSH Pubkey User

You can remove the SSH Pubkey user by using either the WebUI or the CLI.

### In the WebUI

To remove the SSH Pubkey user, perform the following steps:

1. In the **Mobility Master** node hierarchy, navigate to **Configuration > System > Admin**.
2. Click the **Management User** accordion menu.
3. Click the **Show users with certificate authentication** link. The **Management Users with Certificate Authentication** section is displayed.
4. Click the username which you want to delete.
5. Click the bin box icon beside the management user that you want to delete.

### In the CLI

Execute the following command from the Mobility Master node hierarchy:

```
(host) [mynode] (config) #no mgmt-user ssh-pubkey client-cert <certname> <username>
```

Captive portal is one of the methods of authentication supported by ArubaOS. A captive portal presents a web page which requires user action before network access is granted. The required action can be simply viewing and agreeing to an Acceptable Usage Policy (AUP), or entering a user ID and password which must be validated against a database of authorized users.

You can also configure captive portal to allow clients to download the Aruba VPN dialer for Microsoft VPN clients if the VPN is to be terminated on the Mobility Master. For more information about the VPN dialer, see [Virtual Private Networks on page 338](#).

Topics in this chapter include:

- [Understanding Captive Portal on page 287](#)
- [Configuring Captive Portal in the Base Operating System on page 288](#)
- [Using Captive Portal with a PEFNG License on page 290](#)
- [Sample Authentication with Captive Portal on page 292](#)
- [Configuring Guest VLANs on page 300](#)
- [Configuring Captive Portal Authentication Profiles on page 301](#)
- [Enabling Optional Captive Portal Configuration on page 306](#)
- [Personalizing the Captive Portal Page on page 310](#)
- [Creating Walled Garden Access on page 313](#)
- [Enabling Captive Portal Enhancements](#)

## Captive Portal Deployment Models

Captive Portal supports following deployment models:

- 7200 Series Master Controller Mode
- Mobility Master-Managed Device
- Stand-alone Controller

### 7200 Series Master Controller Mode

ArubaOS 8.0.1.0 supports 7200 Series controllers to run as a master controller. In 7200 Series master controller mode deployment model, Captive Portal configuration is allowed on the managed devices and device nodes (device nodes are located within managed devices). However, server-based policy configuration is allowed only on device nodes.

### Mobility Master-Managed Device

Mobility Master is the root of a network hierarchy. A single Mobility Master oversees a number of managed devices that can be co-located or off-campus. In Mobility Master-Managed Device deployment model, all Captive Portal configuration is allowed only on the Mobility Master.

### Stand-alone Controller

Captive Portal is supported in the stand-alone controller mode where the configuration can be performed on the controller irrespective of local or master controller.

## Understanding Captive Portal

You can configure captive portal for guest users, where no authentication is required, or for registered users who must be authenticated against an external server or the managed device's internal database.



---

While you can use captive portal to authenticate users, it does not provide for encryption of user data and should not be used in networks where data security is required. Captive portal is most often used for guest access, access to open systems (such as public hot spots), or as a way to connect to a VPN.

---

You can use captive portal for guest and registered users at the same time. The default captive portal web page provided with ArubaOS displays login prompts for both registered users and guests. (You can customize the default captive portal page, as described in [Personalizing the Captive Portal Page on page 310](#))

You can also load up to 16 different customized login pages into the managed device. The login page displayed is based on the SSID to which the client associates.

### Policy Enforcement Firewall Next Generation (PEFNG) License

You can use captive portal with or without the PEFNG license installed in the Mobility Master. The PEFNG license provides identity-based security to wired and wireless clients through user roles and firewall rules. You must purchase and install the PEFNG license on the Mobility Master to use identity-based security features.

There are differences in how captive portal functions work and how you configure captive portal, depending on whether the license is installed. Other parts of this chapter describe how to configure captive portal in the base operating system (without the PEFNG license) and with the license installed.

### Server Certificate

The Aruba managed device is designed to provide secure services through the use of digital certificates. The server certificate is installed on the managed device through the Mobility Master. A server certificate installed in the managed device verifies the authenticity of the managed devices for captive portal.

Aruba managed device ship with a demonstration self-signed certificate. Until you install a customer-specific server certificate in the managed device, this demonstration self-signed certificate is used by default for all secure HTTP connections such as captive portal. This self-signed certificate is included primarily for the purposes of feature demonstration and convenience and is not intended for long-term use in production networks. Users in a production environment are urged to obtain and install a certificate issued for their site or domain by a well-known certificate authority (CA). You can generate a Certificate Signing Request (CSR) on the managed device to submit to a CA. For information on how to generate a CSR and how to import the CA-signed certificate into the managed device, see [Managing Certificates on page 776](#) in [Management Access on page 760](#).

The managed device can accept wild card server certificates (CN begins with an asterisk). If a wildcard certificate is uploaded (for example, CN=\*.domain.com), the asterisk in CN is replaced with 'captiveportal-login' in order to derive the Captive Portal logon page URL (captiveportal-login.domain.com).

Once you have imported a server certificate from the Mobility Master to managed device, you can select the certificate to be used with captive portal as described in the following sections.

To select a certificate for captive portal using the Mobility Master's WebUI :

1. Login to the Mobility Master.
2. In the **Managed Node** hierarchy, navigate to the **Configuration > System > More > General** accordion.
3. Under **Captive Portal Certificate**, select the name of the imported certificate from the drop-down list.
4. Click **Submit**.
5. Click **Pending Changes**.
6. In the **Pending Changes** window, select the check box and click **Deploy changes**.

To select a certificate for captive portal using the command-line interface, access the CLI in config mode and issue the following commands:

```
(host) [mynode] #cd /md /<MAC_address>
(host) [<MAC_address>] (config) #web-server profile
(host) [<MAC_address>] (Web Server Configuration) #captive-portal-cert <certificate>
```

To specify a different server certificate for captive portal with the CLI, use the **no** command to revert back to the default certificate *before* you specify the new certificate:

```
(host) [<MAC_address>] (config) #web-server profile
(host) [<MAC_address>] (Web Server Configuration) #captive-portal-cert ServerCert1
(host) [<MAC_address>] (Web Server Configuration) #no captive-portal-cert
(host) [<MAC_address>] (Web Server Configuration) #captive-portal-cert ServerCert2
```

## Configuring Captive Portal in the Base Operating System

The base operating system (ArubaOS without any licenses) allows full network access to all users who connect to an ESSID, both guest and registered users. In the base operating system, you cannot configure or customize user roles; this function is only available by installing the PEFNG license. Captive portal allows you to control or identify who has access to network resources.

When you create a captive portal profile in the base operating system, an implicit user role is automatically created in the stand-alone controller and in the Master Controller Mode with same name as the captive portal profile. This implicit user role allows only DNS and DHCP traffic between the client and network and directs all HTTP or HTTPS requests to the captive portal. You cannot directly modify the implicit user role or its rules. Upon authentication, captive portal clients are allowed full access to their assigned VLAN.

In a Mobility Master-managed device topology, Mobility Master does not have the configuration which are related to PEFNG license, therefore the role is not created on the Mobility Master.



---

The WLAN Wizard within the ArubaOS WebUI allows for basic captive portal configuration for WLANs associated with the “default” ap-group: **Configuration > WLAN Wizard**. Follow the steps in the workflow pane within the wizard and refer to the help tab for assistance.

---

What follows are the tasks for configuring captive portal in the base ArubaOS. The example server group and profile names appear inside quotation marks.

- Create the Server Group name. In this example, the server group name is “cp-srv”.  
If you are configuring captive portal for registered users, configure the server(s) and create the server group. For more information about configuring authentication servers and server groups, see [Authentication Servers on page 180](#).
- Create Captive Portal Authentication Profile. In this example, the profile name is “c-portal”.  
Create and configure an instance of the captive portal authentication profile. Creating the captive portal profile automatically creates an implicit user role and ACL with the same name. Creating the profile “c-portal” creates an implicit user role called “c-portal”. That user role allows only DNS and DHCP traffic between the client and network and directs all HTTP or HTTPS requests to the captive portal.
- Create an AAA Profile. In this example, the profile name is “aaa\_c-portal”.  
Create and configure an instance of the AAA profile. For the initial role, enter the implicit user role that was created in [step on page 288](#). The initial role in the profile “aaa\_c-portal” must be set to “c-portal”.
- Create SSID Profile. In this example, the profile name is “ssid\_c-portal”.  
Create and configure an instance of the virtual AP profile which you apply to an AP group or AP name. Specify the AAA profile you created in [step on page 288](#).
- Create a Virtual AP Profile. In this example, the profile name is “vp\_c-portal”.  
Create and configure an instance of the SSID profile for the virtual AP.



The following sections present the procedure for configuring the captive portal authentication profile, the AAA profile, and the virtual AP profile using the WebUI or the command line (CLI). Configuring the VLAN and authentication servers and server groups are described elsewhere in this document.

## In the WebUI

1. Login to the Mobility Master.
2. In the **Managed Network** node hierarchy, navigate to the **Configuration > Authentication > L3 Authentication** page. Select the **Captive Portal Authentication** profile.
  - a. Click + to create a new Captive Portal Authentication Profile, enter the name of the profile (for example, **c-portal**), then click **Submit**.
  - b. Select the captive portal authentication profile you just created.
  - c. You can enable user login and/or guest login, and configure other captive portal profile parameters as described in [Table 56](#).
  - d. Click **Submit**.
3. To specify authentication servers, select Server Group under the captive portal authentication profile you just configured.
  - a. Select the server group (for example, **cp-srv**) from the drop-down list.
  - b. Click **Submit**.
4. Select the **AAA Profiles** tab.
  - a. In the AAA Profiles, click + to add a new profile. Enter the name of the profile (for example, **aaa\_c-portal**), then click **Add**.
  - b. Select the AAA profile you just created.
  - c. For Initial Role, select the captive portal authentication profile (for example, **c-portal**) you created previously for stand-alone controller and Master Controller Mode.



---

The Initial Role must be exactly the same as the name of the captive portal authentication profile you created.

---

- d. Click **Submit**.
5. Under Profiles, select Wireless LAN, then select Virtual AP.
  6. To create a new virtual AP profile, Click + from the **Virtual AP profile: New Profile** pane. Enter the name for the virtual AP profile (for example, **vp\_c-portal**), and click **Save**.
    - a. In the **Profile Details** entry for the new virtual AP profile (**guestnet**), select the AAA profile you previously configured from the **AAA Profile** drop-down list and click **Save**.
    - b. From the **SSID profile** drop-down list, select NEW.
    - c. Enter the name for the SSID profile (for example, **ssid\_c-portal**).
    - d. Enter the Network Name for the SSID (for example, **c-portal-ap**).
    - e. For **Network Authentication**, select None.
    - f. For **Encryption**, select Open.
    - g. At the bottom of the Profile Details page, click **Save**.
  7. Navigate to the **Configuration > AP Groups** page.
  8. Select an AP Group and Click **WLANS** tab in the AP group window.
  9. Click + under the WLANS tab and select the newly create virtual AP profile (guestnet) from the **Virtual-ap** drop-down list.
  10. Click on the new virtual AP name in the Profiles list.
    - a. Click **General** accordion and make sure **Virtual AP enable** is selected.

b. For VLAN, select the ID of the VLAN in which captive portal users are placed (for example, VLAN **20**).

c. Click **Submit**.

11. Click **Pending Changes**.

12. In the **Pending Changes** window, select the check box and click **Deploy changes**.

## In the CLI

To configure captive portal in the base operating system via the command-line interface, access the CLI in config mode and issue the following commands:

```
(host) [md] (config) #aaa authentication captive-portal c-portal
server-group cp-srv
(host) [md] (config) #aaa profile aaa_c-portal
initial-role c-portal
(host) [md] (config) #wlan ssid-profile ssid_c-portal
ssid c-portal-ap
(host) [md] (config) #wlan virtual-ap vp_c-portal
aaa-profile aaa_c-portal
ssid-profile ssid_c-portal
vlan 20
```

## Using Captive Portal with a PEFNG License

The PEFNG license provides identity-based security for wired and wireless users. There are two user roles that are important for captive portal:

- Default user role, which you specify in the captive portal authentication profile, is the role granted to clients upon captive portal authentication. This can be the predefined **guest** system role.
- Initial user role, which you specify in the AAA profile, directs clients who associate to the SSID to captive portal whenever the user initiates a Web browser connection. This can be the predefined **logon** system role. The captive portal authentication profile specifies the captive portal login page and other configurable parameters. The initial user role configuration must include the applicable captive portal authentication profile instance.



---

MAC-based authentication, if enabled on the Mobility Master, takes precedence over captive portal authentication.

---

The following are the basic tasks for configuring captive portal using role-based access provided by the Policy Enforcement Firewall software module. Note that you must install the PEFNG license and enable the respective bit before proceeding (see *Aruba Mobility Master Licensing Guide*).

- Configure the user role for a default user.  
Create and configure user roles and policies for guest or registered captive portal users. (See [Roles and Policies on page 367](#) for more information about configuring policies and user roles.)
- Create a server group.  
If you are configuring captive portal for registered users, configure the server(s) and create the server group. (See [Authentication Servers on page 180](#) for more information about configuring authentication servers and server groups.)



---

If you are using the Managed device's internal database for user authentication, use the predefined "Internal" server group. The "internal" server is the local database on the Mobility Master. You need to configure entries in the internal database, as described in [Authentication Servers on page 180](#).

---

- Create the captive portal authentication profile.  
Create and configure an instance of the captive portal authentication profile. Specify the default user role for captive portal users.
- Configure the initial user role.  
Create and configure the initial user role for captive portal. You need to include the predefined **captiveportal** policy, which directs clients to the captive portal, in the initial user role configuration. You also need to specify the captive portal authentication profile instance in the initial user role configuration. For example, if you are using the predefined **logon** system role for the initial role, you need to edit the role to specify the captive portal authentication profile instance.
- Create the AAA Profile.  
Create and configure an instance of the AAA profile. Specify the initial user role.
- Create the SSID Profile "ssid\_c-portal".  
Create and configure an instance of the virtual AP profile that you apply to an AP group or AP name. Specify the AAA profile you just created.
- Create the Virtual AP Profile "vp\_c-portal".  
Create and configure an instance of the SSID profile for the virtual AP.

The following sections present the WebUI and Command Line (CLI) procedures for configuring the captive portal authentication profile, initial user role, the AAA profile, and the virtual AP profile. Other chapters within this document detail the configuration of the user roles and policies, authentication servers, and server groups.

## Configuring Captive Portal in the WebUI

To configure captive portal with PEFNG license via the WebUI:

1. Login to the Mobility Master.
2. In the **Managed Network** node hierarchy, navigate to the **Configuration > Authentication > L3 Authentication** page. In the Profiles list, select **Captive Portal Authentication** Profile.
  - a. Click + to create a new **Captive Portal Authentication Profile**, enter the name of the profile (for example, **c-portal**), then click **Submit**.
  - b. Select the captive portal authentication profile you just created.
  - c. Select the default role (for example, **employee**) for captive portal users.
  - d. Enable guest login and/or user login, as well as other parameters (refer to [Table 56](#)).
  - e. Click **Submit**.
3. To specify the authentication servers, select Server Group under the captive portal authentication profile you just configured.
  - a. Select the server group (for example, **cp-srv**) from the drop-down list.
  - b. Click **Submit**.
4. Select the **AAA Profiles** tab.
  - a. In the AAA Profiles, click + to add a new profile. Enter the name of the profile (for example, **aaa\_c-portal**), then click **Save**.
  - b. Set the Initial role to a role that you will configure with the captive portal authentication profile.
  - c. Click **Submit**.
5. Navigate to the **Configuration > Roles and Policies**. Click on a role and click + to add a new rule.
  - a. To edit the predefined logon role, select the role and click + in the policies page that opens and select **Access Control**.

- b. To configure a new role, first configure policy rules in the **Policies** tab, then select the **User Roles** tab to add a new user role and assign policies.
  - c. Select the profile from the Captive Portal Profile drop-down list in Authentication tab under the selected Role.
  - d. Click **Submit**.
6. Navigate to the **Configuration > AP Group** page to configure the virtual AP profile.
  7. Select the AP Group . Click + for the applicable AP group name or AP name.
  8. Under Profiles, select Wireless LAN, then select Virtual AP.
  9. Select NEW from the Add a profile drop-down list to create a new virtual AP profile. Enter the name for the virtual AP profile (for example, **vp\_c-portal**), then click **Save**.
    - a. In the Profile Details entry for the new virtual AP profile, select the AAA profile you previously configured. A pop-up window displays the configured AAA profile parameters. Click **Save**.
    - b. From the SSID profile drop-down list, select NEW. A pop-up window allows you to configure the SSID profile.
    - c. Enter the name for the SSID profile (for example, **ssid\_c-portal**).
    - d. Enter the Network Name for the SSID (for example, **c-portal-ap**).
    - e. At the bottom of the Profile Details page, click **Submit**.
  10. Click on the new virtual AP name in the Profiles list or in Profile Details to display configuration parameters.
    - a. Make sure Virtual AP enable is selected.
    - b. For VLAN, select the VLAN to which users are assigned (for example, **900**).
    - c. Click **Submit**.
  11. Click **Pending Changes**.
  12. In the **Pending Changes** window, select the check box and click **Deploy changes**.

## Configuring Captive Portal in the CLI

To configure captive portal with the PEFNG license via the command-line interface, access the CLI in config mode and issue the following commands:

```
(host) [md] (config) #aaa authentication captive-portal c-portal
  default-role employee
  server-group cp-srv
(host) [md] (config) #user-role logon
(host) [md] (config-submode) #access-list session c-portal
  captive-portal c-portal
(host) [md] (config) #aaa profile aaa_c-portal
  initial-role logon
(host) [md] (config) #wlan ssid-profile ssid_c-portal
  essid c-portal-ap
  vlan 900
(host) [md] (config) #wlan virtual-ap vp_c-portal
  aaa-profile aaa_c-portal
  ssid-profile ssid_c-portal
```

## Sample Authentication with Captive Portal

In the following example:

- Guest clients associate to the **guestnet** SSID which is an open wireless LAN. Guest clients are placed into VLAN 900 and assigned IP addresses by the managed devices's internal DHCP server. The user has no access to network resources beyond DHCP and DNS until they open a web browser and log in with a guest account using captive portal.

- Guest users are given a login and password from guest accounts created in the managed devices's internal database. The temporary guest accounts are created and administered by the site receptionist.
- Guest users must enter their assigned login and password into the captive portal login before they are given access to use web browsers (HTTP and HTTPS), POP3 email clients, and VPN clients (IPsec, PPTP, and L2TP) on the Internet and only during specified working hours. Guest users are prohibited from accessing internal networks and resources. All traffic to the Internet is source-NATed.




---

This example assumes a Policy Enforcement Firewall Next Generation (PEFNG) license is installed in the Mobility Master.

---

In this example, you create two user roles:

- **guest-logout** is a user role assigned to any client who associates to the guestnet SSID. Normally, any client that associates to an SSID will be placed into the *logon* system role. The **guest-logout** user role is more restrictive than the logon role.
- **auth-guest** is a user role granted to clients who successfully authenticate via the captive portal.

## Creating a Guest User Role

The **guest-logout** user role consists of the following ordered policies:

- **captiveportal** is a predefined policy that allows captive portal authentication.
- **guest-logout-access** is a policy that you create with the following rules:
  - Allows DHCP exchanges between the user and the DHCP server during business hours while blocking other users from responding to DHCP requests.
  - Allows ICMP exchanges between the user and the managed devices during business hours.
- **block-internal-access** is a policy that you create that denies user access to the internal networks.




---

The **guest-logout** user role configuration needs to include the name of the captive portal authentication profile instance. You can modify the user role configuration after you create the captive portal authentication profile instance.

---

## Creating an Auth-guest User Role

The **auth-guest** user role consists of the following ordered policies:

- **cplogout** is a predefined policy that allows captive portal logout.
- **guest-logout-access** is a policy that you create with the following rules:
  - Allows DHCP exchanges between the user and the DHCP server during business hours while blocking other users from responding to DHCP requests.
  - Allows DNS exchanges between the user and the public DNS server during business hours. Traffic is source-NATed using the IP interface of the managed devices for the VLAN.
- **block-internal-access** is a policy that you create that denies user access to the internal networks.
- **auth-guest-access** is a policy that you create with the following rules:
  - Allows DHCP exchanges between the user and the DHCP server during business hours while blocking other users from responding to DHCP requests.
  - Allows DNS exchanges between the user and the public DNS server during business hours. Traffic is source-NATed using the IP interface of the managed devices for the VLAN.
  - Allows HTTP/S traffic from the user during business hours. Traffic is source-NATed using the I interface of the managed devices for the VLAN.
- **drop-and-log** is a policy that you create that denies all traffic and logs the attempted network access.

## Configuring Policies and Roles in the WebUI

### Creating a Time Range

To create the guest-logon-access policy via the WebUI:

1. Login to the Mobility Master.
2. In the **Managed Network** node hierarchy, navigate to the **Configuration > Roles & Policies > Policies** page.
3. Select **+** to add the guest-logon-access policy.
4. For Policy Name, enter **guest-logon-access**.
5. For Policy Type, select **IPv4 Session**.
6. Click **Submit**.
7. Select the newly created **guest-logon-access** policy.
8. Click **+** under the **Policies > guest-logon-access** table.
9. In the **New Rule for guest-logon-access** popup, select **Access Control** option and click OK.
10. Under the **Roles > guest-logon-access > New forwarding Rules** table, to add a new rule select the following options:
  - a. Under Source, select **user**.
  - b. Under Destination, select **any**.
  - c. Under Service, select **udp**. Enter **68**.
  - d. Under Action, select **deny**.
  - e. Click **Submit**.
  - f. For the time range, select **+** and enter the following for adding a new time range:
    - For Name, enter **working-hours**.
    - For Type, select **Periodic** and click **+**.
    - For Start Day, click **Weekday**.
    - For Start Time, enter **07:30**.
    - For End Time, enter **17:00**.
    - Click **Submit**.
11. Add another new rule for the guest-logon-access:
  - a. Under Source, select **any**.
  - b. Under Destination, select **any**.
  - c. Under Service, select **service**. Select **svc-dhcp**.
  - d. Under Action, select **permit**.
  - e. Under Time Range, select **working-hours**.
  - f. Click **Submit**.
12. Click **Pending Changes**.
13. In the **Pending Changes** window, select the check box and click **Deploy changes**.

### Creating Aliases

The following step defines an alias representing the public DNS server addresses. Once defined, you can use the alias for other rules and policies.

1. Login to the Mobility Master.

2. In the **Managed Network** node hierarchy, navigate to the **Configuration > Roles & policies> Policies** page.
3. Select **+** to add the guest-logon-access policy.
4. For Policy Name, enter **guest-logon-access**.
5. For Policy Type, select **IPv4 Session**.
6. Click **Submit**.
7. Select the newly created **guest-logon-access** policy.
8. Click **+** under the **Policies > guest-logon-access** table.
9. In the **New Rule for guest-logon-access** popup, select **Access Control** option and click OK.
10. Under the **Roles > guest-logon-access > New forwarding Rules** table, to add a new rule select the following options:
  - a. Under Source, select **user**.
  - b. Under Destination, select **alias**.
  - c. Under the alias selection, click **+**.
    - IP version is IPv4.
    - For Destination name, enter "Public DNS".
    - For Destination description, enter public-dns.
    - Under the Rule section, click **+**:
      - For Rule Type, select **host**.
      - For **IP Address**, enter 64.151.103.120.
      - Click **OK**.
      - Click **Submit**. The alias "Public DNS" appears in the Destination menu
  - d. Under Destination, select Public DNS.
  - e. Under Service, select **svc-dns**.
  - f. Under Action, select **src-nat**.
  - g. Under Time Range, select **working-hours**.
  - h. Click **Submit**.
11. Click **Pending Changes**.
12. In the **Pending Changes** window, select the check box and click **Deploy changes**.

### Creating an Auth-Guest-Access Policy

To configure the auth-guest-access policy via the WebUI:

1. Login to the Mobility Master.
2. In the **Managed Networks** node hierarchy, navigate to the **Configuration > Roles & Policies > Policies** page.
3. Select **+** to create the policy.
4. For Policy Name, enter **auth-guest-access**.
5. For Policy Type, select **IPv4 Session**.
6. Click **Submit**.
7. Select the newly created **auth-guest-access** policy.
8. Click **+** under the **Policies > auth-guest-access** table.
9. In the **New Rule for auth-guest-access** popup, select **Access Control** option and click OK.

10. Under the **Roles > auth-guest-access > New forwarding Rules** table, to add a new rule select the following options:
  - a. Under Source, select **user**.
  - b. Under Destination, select **any**.
  - c. Under Service, select **udp**. Enter **68**.
  - d. Under Action, select **deny**.
  - e. Click **Submit**.
11. Under the **Roles > auth-guest-access > New forwarding Rules** table, select the following options to add another rule.
  - a. Under Source, select **any**.
  - b. Under Destination, select **any**.
  - c. Under Service, select **service**. Select **svc-dhcp**.
  - d. Under Action, select **permit**.
  - e. Under Time Range, select **working-hours**.
  - f. Click **Submit**.
12. Under the **Roles > auth-guest-access > New forwarding Rules** table, select the following options to add another rule.
  - a. Under Source, select **user**.
  - b. Under Destination, select **alias**. Select **Public DNS** from the drop-down list.
  - c. Under Service, select **service**. Select **svc-dns**.
  - d. Under Action, select **src-nat**.
  - e. Under Time Range, select **working-hours**.
  - f. Click **Submit**.
13. Under the **Roles > auth-guest-access > New forwarding Rules** table, select the following options to add another rule.
  - a. Under Source, select **user**.
  - b. Under Destination, select **any**.
  - c. Under Service, select **service**. Select **svc-http**.
  - d. Under Action, select **src-nat**.
  - e. Under Time Range, select **working-hours**.
  - f. Click **Submit**.
14. Under the **Roles > auth-guest-access > New forwarding Rules** table, select the following options to add another rule.
  - a. Under Source, select **user**.
  - b. Under Destination, select **any**.
  - c. Under Service, select **service**. Select **svc-https**.
  - d. Under Action, select **src-nat**.
  - e. Under Time Range, select **working-hours**.
  - f. Click **Submit**.
15. Click **Submit**.
16. Click **Pending Changes**.
17. In the **Pending Changes** window, select the check box and click **Deploy changes**.



## Creating an Block-Internal-Access Policy

To create the block-internal-access policy via the WebUI:

1. Login to the Mobility Master.
2. In the **Managed Networks** node hierarchy, navigate to the **Configuration > Roles & Policies > Policies** page.
3. Select **+** to add a new policy.
4. For Policy Name, enter **block-internal-access**.
5. For Policy Type, select **IPv4 Session**.
6. Click **Submit**.
7. Select the newly created **block-internal-access** policy.
8. Click **+** under the **Policies > block-internal-access** table.
9. In the **New Rule for block-internal-access** popup, select **Access Control** option and click OK.
10. Under the **Roles > block-internal-access > New forwarding Rules** table, to add a new rule select the following options:
  - a. Under Source, select **user**.
  - b. Under Destination, select **alias**.



---

The following step defines an alias representing all internal network addresses. Once defined, you can use the alias for other rules and policies.

---

- c. Under the alias selection, click **+**.
    - IP version is IPv4.
    - For Destination name, enter "Internal Network".
    - For Destination description, enter internal\_network.
    - Under the Rule section, click **+**:
    - For Rule Type, select **network**.
    - For **IP Address**, enter 10.0.0.0.
    - For Network Mask/Range, enter 255.0.0.0.
    - Click **OK**.
    - Repeat these steps to add the network ranges 172.16.0.0 255.240.0.0 and 192.168.0.0 255.255.0.0.
    - Click **Submit**. The alias "Internal Network" appears in the Destination menu
  - d. Under Destination, select Internal Network.
  - e. Under Service, select **any**.
  - f. Under Action, select **deny**.
  - g. Click **Submit**.
11. Click **Submit**.
  12. Click **Pending Changes**.
  13. In the **Pending Changes** window, select the check box and click **Deploy changes**.

## Creating a Drop-and-Log Policy

To create the drop-and-log policy via the WebUI:

1. Login to the Mobility Master.

2. In the **Managed Networks** node hierarchy, navigate to the **Configuration > Roles & Policies > Policies** page.
3. Select **+** to add a new policy.
4. For Policy Name, enter **drop-and-log**.
5. For Policy Type, select **IPv4 Session**.
6. Click **Submit**.
7. Select the newly created **drop-and-log** policy.
8. Click **+** under the **Policies > drop-and-log** table.
9. In the **New Rule for drop-and-log** popup, select **Access Control** option and click OK.
10. Under the **Roles > drop-and-log > New forwarding Rules** table, to add a new rule select the following options:
  - a. Under Source, select **user**.
  - b. Under Destination, select **any**.
  - c. Under Service, select **any**.
  - d. Under Action, select **deny**.
  - e. Select **Log**.
  - f. Click **Submit**.
11. Click **Submit**.
12. Click **Pending Changes**.
13. In the **Pending Changes** window, select the check box and click **Deploy changes**.

### Creating a Guest Role

To create a guest role via the WebUI:

1. Login to the Mobility Master.
2. In the **Managed Networks** node hierarchy, navigate to the **Configuration > Roles & Policies > Roles** page.
3. Click **+** to add a new role.
4. Enter guest-logon as a New Role.
5. Select the role name you just created and click **Show Advanced View**.
6. Click **+** under the **Roles > guest-logon role > Policies**.
7. In the **Add Policy** popup, select the **Add an existing policy** option.
8. Select the policy name as guest-logon-access from the drop-down list
9. Click **Submit**.
10. Similarly, add block-internal-access policy for the role guest-logon..
11. Click **Submit**.
12. Click **Pending Changes**.
13. In the **Pending Changes** window, select the check box and click **Deploy changes**.

### Creating an Auth-Guest Role

To create the guest-logon role via the WebUI:

1. Login to the Mobility Master.
2. In the **Managed Network** node hierarchy, navigate to the **Configuration > Roles & Policies > User Roles** page.
3. Click **+** to add a new role.

4. Enter **auth-guest** as a New Role.
5. Select the role name you just created and click **Show Advanced View**.
6. Click + under the **Roles > auth-guest role> Policies**.
7. In the **Add Policy** pop-up, select the **Add an existing policy** option.
8. Select the policy name as **cplogout** from the drop-down list
9. Click **Submit**.
10. Similarly, add guest-logon-access, block-internal-access, auth-guest-access, drop-and-log policies for the role **auth-guest**.
11. Click **Submit**.
12. Click **Pending Changes**.
13. In the **Pending Changes** window, select the check box and click **Deploy changes**.

## Configuring Policies and Roles in the CLI

### Defining a Time Range

To create a time range via the command-line interface, access the CLI in config mode and issue the following commands:

```
(host) [md] (config) #time-range working-hours periodic
    weekday 07:30 to 17:00
```

### Creating Aliases

To create aliases via the command-line interface, access the CLI in config mode and issue the following commands:

```
(host) [md] (config) #netdestination "Internal Network"
network 10.0.0.0 255.0.0.0
network 172.16.0.0 255.255.0.0
    network 192.168.0.0 255.255.0.0
(host) (config) #netdestination "Public DNS"
    host 64.151.103.120
    host 216.87.84.209
```

### Creating a Guest-Logon-Access Policy

To create a guest-logon-access policy via the command-line interface, access the CLI in config mode and issue the following commands:

```
(host) (config) #ip access-list session guest-logon-access
    user any udp 68 deny
    any any svc-dhcp permit time-range working-hours
    user alias "Public DNS" svc-dns src-nat time-range working-hours
```

### Creating an Auth-Guest-Access Policy

To create an auth-guest-access policy via the command-line interface, access the CLI in config mode and issue the following commands:

```
(host) [md] (config) #ip access-list session auth-guest-access
    user any udp 68 deny
    any any svc-dhcp permit time-range working-hours
    user alias "Public DNS" svc-dns src-nat time-range working-hours
    user any svc-http src-nat time-range working-hours
    user any svc-https src-nat time-range working-hours
```

## Creating a Block-Internal-Access Policy

To create a block-internal-access policy via the command-line interface, access the CLI in config mode and issue the following commands:

```
(host) [md] (config) #ip access-list session block-internal-access
    user alias "Internal Network" any deny
```

## Creating a Drop-and-Log Policy

To create a drop-and-log policy via the command-line interface, access the CLI in config mode and issue the following commands:

```
(host) [md] (config) #ip access-list session drop-and-log
    user any any deny log
```

## Creating an Auth-Guest Role

To create an auth-guest role via the command-line interface, access the CLI in config mode and issue the following commands:

```
(host) [md] (config) #user-role auth-guest
(host) [md] (config-submode)#access-list session captiveportal
    (host) [md] (config-submode)#access_list cplogout position 1
    (host) [md] (config-submode)#access_list guest-logon-access position 2
    (host) [md] (config-submode)#access_list block-internal-access position 3
    (host) [md] (config-submode)#access_list auth-guest-access position 4
    (host) [md] (config-submode)#access_list drop-and-log position 5
```

## Configuring Guest VLANs

Guests using the WLAN are assigned to VLAN 900 and are given IP addresses via DHCP from the managed devices.

### In the WebUI

1. Login to the Mobility Master.
2. In the **Managed Network** node hierarchy, navigate to the **Configuration > Interfaces** window and select the **VLANs** tab.
3. Click + to add a new VLAN.
4. Enter the **VLAN name** as guest\_vlan.
5. Enter **VLAN ID/Range** as 900.
6. Click **Submit**.
7. Select the VLAN name from the **VLANs** table and the **VLANs > <VLAN name>** table is displayed.
8. Click on the VLAN ID, 900 and enter the following:
  - a. For IPv4 Address, enter 192.168.200.20.
  - b. Click **Submit**.
9. Navigate to **Configuration > Services > DHCP Server** tab.
  - a. Select **Enabled** for **IPv4 DHCP Server**.
  - b. Click + under Pool Configuration.
  - c. In the **Pool Name** field, enter **guestpool**.
  - d. In the **Default Router** field, enter 192.168.200.20.
  - e. In the **DNS Server** field, enter 64.151.103.120.
  - f. In the **Lease** field, enter 4 hours.

- g. In the **Network** field, enter 192.168.200.0. In the **Netmask** field, enter 255.255.255.0.
  - h. Click **Submit**.
10. Click **Submit**.
  11. Click **Pending Changes**.
  12. In the **Pending Changes** window, select the check box and click **Deploy changes**.

## In the CLI

```

host) [mynode] #cd /md /<MAC_address>
(host) [<MAC_address>] (config)
(host) [<MAC_address>] (config) #vlan 900
(host) [<MAC_address>] (config) #interface vlan 900
(host) [<MAC_address>] (config) #ip address 192.168.200.20 255.255.255.0
(host) [<MAC_address>] (config) #ip dhcp pool "guestpool"
(host) [<MAC_address>] (config) #default-router 192.168.200.20
(host) [<MAC_address>] (config) #dns-server 64.151.103.120
(host) [<MAC_address>] (config) #lease 0 4 0
(host) [<MAC_address>] (config) #network 192.168.200.0 255.255.255.0

```

## Configuring Captive Portal Authentication Profiles

In this section, you create an instance of the captive portal authentication profile and the AAA profile. For the captive portal authentication profile, you specify the previously-created **auth-guest** user role as the default user role for authenticated captive portal clients and the authentication server group ("Internal").

To configure captive portal authentication via the WebUI:

1. Login to the Mobility Master.
2. In the **Managed Network** node hierarchy, navigate to the **Configuration > Authentication > L3 Authentication** page. In the Profiles list, select **Captive Portal Authentication** Profile.
  - a. Click + to create a new Captive Portal Authentication Profile, enter the name of the profile as **guestnet** for the name of the profile, then click **Submit**.
  - b. Select the captive portal authentication profile you just created.
  - c. For Default Role, select **guest**.
  - d. Select User Login.
  - e. Deselect (uncheck) **Guest Login**.
  - f. Click **Submit**.
3. Select **Server Group** under the **guestnet** captive portal authentication profile you just created.
  - a. Select **internal** from the **Server Group** drop-down list.
  - b. Click **Submit**.
4. Click **Pending Changes**.
5. In the **Pending Changes** window, select the check box and click **Deploy changes**.

To configure captive portal authentication via the command-line interface, access the CLI in config mode and issue the following commands:

```

(host) [md] (config) #aaa authentication captive-portal guestnet
    default-role auth-guest
    user-logon
    no guest-logon
    server-group internal

```

## Modifying the Initial User Role

The captive portal authentication profile specifies the captive portal login page and other configurable parameters. The initial user role configuration must include the applicable captive portal authentication profile instance. Therefore, you need to modify the **guest-logon** user role configuration to include the **guestnet** captive portal authentication profile.

To modify the guest-logon role via the WebUI:

1. Login to the Mobility Master.
2. In the **Managed Network** node hierarchy, navigate to the **Configuration > Roles & Policies > Roles** page.
3. Select the **guest-logon** role.
4. Select **Show Advanced View** in the **Roles > guest-logon** table.
5. Select the **More** tab.
6. Select **Authentication** accordion.
7. Select the captive portal authentication profile you just created from the **Captive Portal Profile** drop-down list, and click **Submit**.
8. Click **Pending Changes**.
9. In the **Pending Changes** window, select the check box and click **Deploy changes**.

To modify the guest-logon role via the command-line interface, access the CLI in config mode and issue the following commands:

```
(host) [md] (config) #user-role guest-logon
      (host) [md] (config-submode)#access-list session captiveportal
      captive-portal guestnet
```

## Configuring the AAA Profile

In this section, you configure the **guestnet** AAA profile, which specifies the previously-created **guest-logon** role as the initial role for clients who associate to the WLAN.

To configure the AAA profile via the WebUI:

1. Login to the Mobility Master.
2. In the **Managed Network** node hierarchy, navigate to the **Configuration > Authentication > AAA Profiles** page.
3. Expand **AAA**. In the **AAA Profiles:New Profile**, click **+** to add a new profile. Enter **guestnet** for the name of the profile, then click **Submit**.
4. Select **guest-logon** from **Initial role** drop-down list.
5. Click **Submit**.
6. Click **Pending Changes**.
7. In the **Pending Changes** window, select the check box and click **Deploy changes**.

To configure the AAA profile via the command-line interface, access the CLI in config mode and issue the following commands:

```
(host) [md] (config) #aaa profile guestnet
      initial-role guest-logon
```

## Configuring the WLAN

In this section, you create the **guestnet** virtual AP profile for the WLAN. The **guestnet** virtual AP profile contains the SSID profile **guestnet** (which configures opensystem for the SSID) and the AAA profile **guestnet**.

To configure the guest WLAN via the WebUI:

1. Login to the Mobility Master.
2. In the **Managed Network** node hierarchy, navigate to **Configuration > System > Profiles**.
3. Under **All Profiles**, select Wireless LAN, then select Virtual AP.
4. To create a new virtual AP profile, Click + from the **Virtual AP profile: New Profile** pane. Enter the name for the virtual AP profile (for example, **guestnet**), and click **Submit**.
  - a. In the Profile Details entry for the new virtual AP profile (**guestnet**), select the AAA profile you previously configured from the **AAA Profile** drop-down list and click **Submit**.
  - b. From the SSID profile drop-down list, select NEW.
  - c. Enter the name for the SSID profile (for example, **guestnet**).
  - d. Enter the Network Name for the SSID (for example, **guestnet**).
  - e. For Network Authentication, select None.
  - f. For Encryption, select Open.
  - g. Click **Apply** in the pop-up window.
  - h. At the bottom of the Profile Details page, click **Submit**.
5. Navigate to the **Configuration > AP Groups** page.
6. Select an AP Group and Click **WLANS** tab in the AP group window.
7. Click + under the WLANS tab and select the newly create virtual AP profile (guestnet) from the **Virtual-ap** drop-down list and click **Submit**.
8. Click on the new virtual AP name in the All Profiles list.
  - a. Click **General** accordion and make sure **Virtual AP enable** is selected.
  - b. For VLAN, select the ID of the VLAN in which captive portal users are placed (for example, VLAN **900**).
  - c. Click **Submit**.
9. Click **Pending Changes**.
10. In the **Pending Changes** window, select the check box and click **Deploy changes**.

To configure the guest WLAN via the command-line interface, access the CLI in config mode and issue the following commands:

```
(host) [md] (config) #wlan ssid-profile guestnet
    ssid guestnet
    opmode opensystem
```

```
(host) [md] (config) #aaa profile guestnet
    initial-role guest-logon
```

```
(host) [md] (config) #wlan virtual-ap guestnet
    vlan 900
    aaa-profile guestnet
    ssid-profile guestnet
```

## Managing User Accounts

Temporary user accounts are created in the internal database on the Mobility Master. You can create a user role which will allow a receptionist to create temporary user accounts. Guests can use the accounts to log into a captive portal login page to gain Internet access.

See [Creating Guest Accounts on page 796](#) for more information about configuring guest provisioning users and administering guest accounts.

## Configuring Captive Portal Configuration Parameters

[Table 56](#) describes configuration parameters on the WebUI Captive Portal Authentication profile page.



In the CLI, you configure these options with the **aaa authentication captive-portal** commands.

**Table 56:** *Captive Portal Authentication Profile Parameters*

Parameter	Description
Default Role	Role assigned to the Captive Portal user upon login. When both user and guest logon are enabled, the default role applies to the user logon; users logging in using the guest interface are assigned the guest role. Default: guest
Default Guest Role	Role assigned to guest. Default: guest
Redirect Pause	Time, in seconds, that the system remains in the initial welcome page before redirecting the user to the final web URL. If set to 0, the welcome page displays until the user clicks on the indicated link. Default: 10 seconds
Login Page	URL of the page that appears for the user logon. This can be set to any URL. Default: /auth/index.html
User Login	Enables Captive Portal with authentication of user credentials. Default: Enabled
Guest Login	Enables Captive Portal logon without authentication. Default: Disabled
Logout popout window	Enables a pop-up window with the Logout link for the user to logout after logon. If this is disabled, the user remains logged in until the user timeout period has elapsed or the station reloads. Default: Enabled
Use HTTP for authentication	Use HTTP protocol on redirection to the Captive Portal page. If you use this option, modify the captive portal policy to allow HTTP traffic. Default: disabled (HTTPS is used)
Logon wait minimum wait	Minimum time, in seconds, the user will have to wait for the logon page to pop up if the CPU load is high. This works in conjunction with the Logon wait CPU utilization threshold parameter. Default: 5 seconds
Logon wait maximum wait	Configure parameters for the logon wait interval Default: 10 seconds



Parameter	Description
Logon wait CPU utilization threshold	CPU utilization percentage above which the Logon wait interval is applied when presenting the user with the logon page. Default: 60%
Max Authentication failures	Maximum number of authentication failures before the user is blacklisted. Default: 0
Show FDQN	Allows the user to see and select the fully-qualified domain name (FQDN) on the login page. The FQDNs shown are specified when configuring individual servers for the server group used with captive portal authentication. Default: Disabled
Authentication Protocol	Select the PAP, CHAP or MS-CHAPv2 authentication protocol. <b>NOTE:</b> Do not use the CHAP = option unless instructed to do so by an Aruba representative.
Logon Page	URL of the page that appears before logon. This can be set to any URL. Default: /auth/index.html
Welcome Page	URL of the page that appears after logon and before redirection to the web URL. This can be set to any URL. Default: /auth/welcome.html
Show Welcome Page	Displays the configured welcome page before the user is redirected to their original URL. If this option is disabled, users are redirected to the web URL immediately after they log in. Default: Enabled
Add switch IP address in redirection URL	Sends the managed devices's IP address in the redirection URL when external captive portal servers are used. An external captive portal server can determine the managed devices from which a request originated by parsing the 'switchip' variable in the URL. Default: Disabled
Add User VLAN in the Redirection URL	Sends the user's VLAN ID in the redirection URL when external captive portal servers are used.
Add a controller interface in the redirection URL	Sends the managed devices's interface IP address in the redirection URL when external captive portal servers are used. An external captive portal server can determine the managed devices from which a request originated by parsing the 'switchip' variable in the URL. This parameter requires the Public Access license.
Allow only one active user session	Allows only one active user session at a time. Default: Disabled

Parameter	Description
White List	<p>To add a netdestination to the captive portal whitelist, enter the destination host or subnet, then click <b>Add</b>. The netdestination will be added to the whitelist. To remove a netdestination from the whitelist, select it in the whitelist field, then click <b>Delete</b>.</p> <p>If you have not yet defined a netdestination, use the CLI command <b>netdestination</b> to define a destination host or subnet before you add it to the whitelist.</p> <p>This parameter requires the Public Access license.</p>
Black List	<p>To add a netdestination to the captive portal blacklist, enter the destination host or subnet, then click <b>Add</b>. The netdestination will be added to the blacklist. To remove a netdestination from the blacklist, select it in the blacklist field, then click <b>Delete</b>.</p> <p>If you have not yet defined a netdestination, use the CLI command <b>netdestination</b> to define a destination host or subnet before you add it to the blacklist.</p>
Show Acceptable Use Policy Page	<p>Show the acceptable use policy page before the logon page.</p> <p>Default: Disabled</p>
User idle timeout	<p>The user idle timeout value for this profile. Specify the idle timeout value for the client in seconds. Valid range is 30-15300 in multiples of 30 seconds. Enabling this option overrides the global settings configured in the AAA timers. If this is disabled, the global settings are used.</p>
Redirect URL	<p>URL to which an authenticated user will be directed. This parameter must be an absolute URL that begins with either <b>http://</b> or <b>https://</b>.</p>
URL Hash Key	<p>If a redirection URL is defined, enter a URL Hash Key to hash the redirect URL using the specified key.</p> <p>This parameter enhances security for the ClearPass Guest login URL so that ClearPass Policy Manager can trust and ensure that the client MAC address in the redirect URL has not been tampered with by anyone. Default: Disabled.</p>

## Enabling Optional Captive Portal Configuration

The following are optional captive portal configurations:

- [Uploading Captive Portal Pages by SSID Association on page 306](#)
- [Changing the Protocol to HTTP on page 307](#)
- [Configuring Redirection to a Proxy Server on page 308](#)
- [Redirecting Clients on Different VLANs on page 309](#)
- [Web Client Configuration with Proxy Script on page 310](#)

### Uploading Captive Portal Pages by SSID Association

You can upload custom login pages for captive portal into the managed device through the WebUI. The SSID to which the client associates determines the captive portal login page displayed.

You specify the captive portal login page in the captive portal authentication profile, along with other configurable parameters. The initial user role configuration must include the applicable captive portal authentication profile instance. (In the case of captive portal in the base operating system, the initial user role

is automatically created when you create the captive portal authentication profile instance.) You then specify the initial user role for captive portal in the AAA profile for the WLAN.

When you have multiple captive portal login pages loaded in the managed device, you must configure a unique initial user role and user role, and captive portal authentication profile, AAA profile, SSID profile, and virtual AP profile for each WLAN that will use captive portal. For example, if you want to have different captive portal login pages for the engineering, business and faculty departments, you need to create and configure according to [Table 57](#).

**Table 57:** *Captive Portal login Pages*

Entity	Engineering	Business	Faculty
Captive portal login page	eng-login.html	bus-login.html	fac-login.html
Captive portal user role	eng-user	bus-user	fac-user
Captive portal authentication profile	eng-cp (Specify eng-login.html and eng-user)	bus-cp (Specify bus-login.html and bus-user)	fac-cp (Specify bus-login.html and fac-user)
Initial user role	eng-logon (Specify the eng-cp profile)	bus-logon (Specify the bus-cp profile)	fac-logon (Specify the fac-logon profile)
AAA profile	eng-aaa (Specify the eng-logon user role)	bus-aaa (Specify the bus-logon user role)	fac-aaa (Specify the fac-logon user role)
SSID profile	eng-ssid	bus-ssid	fac-ssid
Virtual AP profile	eng-vap	bus-vap	fac-vap

## Changing the Protocol to HTTP

By default, the HTTPS protocol is used on redirection to the Captive Portal page. If you need to use HTTP instead, you need to do the following:

- Modify the captive portal authentication profile to enable the HTTP protocol.
- *For captive portal with role-based access only*—Modify the **captiveportal** policy to permit HTTP traffic instead of HTTPS traffic.

In the base operating system, the implicit ACL captive-portal-profile is automatically modified.

To change the protocol to HTTP via the WebUI:

1. Login to the Mobility Master.
2. In the **Managed Network** node hierarchy, edit the captive portal authentication profile by navigating to the **Configuration > Authentication > L3 Authentication** page.
3. Select a captive portal profile, enable the **Use HTTP for authentication** check box and click **Submit**.

4. (For captive portal with role-based access only) Edit the **captiveportal** policy by navigating to the **Configuration > Roles & Policies > Policies** page.
  - a. Select the policy for which you want to add/delete a new rule.
  - b. First, delete the rule for “user mswitch svc-https dst-nat”.
  - c. Add a new rule with the following values:
    - **Source** is user.
    - **Destination** is the mswitch alias.
    - **Service** is svc-http.
    - **Action** is dst-nat.
  - d. Click **Submit**.
5. Click **Pending Changes**.
6. In the **Pending Changes** window, select the check box and click **Deploy changes**.

To change the protocol to HTTP via the command-line interface, access the CLI in config mode and issue the following commands:

```
(host) [md] (config) #aaa authentication captive-portal profile
protocol-http
```

(For captive portal with role-based access only)

```
(host) [md] (config) #ip access-list session captiveportal
no user alias mswitch svc-https dst-nat
user alias mswitch svc-http dst-nat
user any svc-http dst-nat 8080
user any svc-https dst-nat 8081
```

## Configuring Redirection to a Proxy Server

You can configure captive portal to work with proxy Web servers. When proxy Web servers are used, browser proxy server settings for end users are configured for the proxy server’s IP address and TCP port. When the user opens a Web browser, the HTTP/S connection request must be redirected from the proxy server to the captive portal on the managed devices.

To configure captive portal to work with a proxy server:

- (For captive portal with base operating system) Modify the captive portal authentication profile to specify the proxy server’s IP address and TCP port.
- (For captive portal with role-based access) Modify the **captiveportal** policy to have traffic for the proxy server’s port destination NATed to port 8088 on the managed device.

The base operating system automatically modifies the implicit ACL *captive-portal-profile*.

The following sections describe how use the WebUI and CLI to configure the captive portal with a proxy server.




---

When HTTPS traffic is redirected from a proxy server to the managed device, the user’s browser will display a warning that the subject name on the certificate does not match the hostname to which the user is connecting.

---

To redirect proxy server traffic using the WebUI:

1. Login to the Mobility Master.
2. For captive portal with Aruba base operating system, in the **Managed Network** node hierarchy, edit the captive portal authentication profile by navigating to the **Configuration > Authentication > L3 Authentication** page.
  - a. Select a captive portal profile and enter the IP address and port for the proxy server.
  - b. Click **Submit**.

3. For captive portal with role-based access, edit the **captiveportal** policy by navigating to the **Configuration > Roles and Policies > Policies** page.
4. Add a new rule with the following values:
  - a. **Source** is user.
  - b. **Destination** is any.
  - c. **Service** is TCP.
  - d. **Port** is the TCP port on the proxy server.
  - e. **Action** is dst-nat.
  - f. **IP address** is the IP address of the proxy port.
  - g. **Port** is the port on the proxy server.
5. Click **Submit**.
6. Click **Pending Changes**.
7. In the **Pending Changes** window, select the check box and click **Deploy changes**.

To redirect proxy server traffic via the command-line interface, access the CLI in config mode and issue the following commands.

For captive portal with Aruba base operating system:

```
(host) [md] (config) #aaa authentication captive-portal profile
proxy host ipaddr port port
```

For captive portal with role-based access:

```
(host) [md] (config) #ip access-list session captiveportal
user alias mswitch svc-https permit
user any tcp port dst-nat 8088
user any svc-http dst-nat 8080
user any svc-https dst-nat 8081
```

## Redirecting Clients on Different VLANs

You can redirect wireless clients that are on different VLANs (from the managed device's IP address) to the captive portal on the managed device. To do this:

1. Specify the redirect address for the captive portal.
2. For captive portal with the PEFNG license only, you need to modify the **captiveportal** policy that is assigned to the user. To do this:
  - a. Create a network destination alias to the managed device interface.
  - b. Modify the rule set to allow HTTPS to the new alias instead of the mswitch alias.




---

In the base operating system, the implicit ACL *captive-portal-profile* is automatically modified.

---

This example shows how to use the command-line interface to create a network destination called cp-redirect and use that in the captive portal policy:

```
(host) [md] (config ) #ip cp-redirect-address ipaddr
```

For captive portal with PEFNG license:

```
(host) [md] (config) #netdestination cp-redirect
(host) [md] (config-submode)#ip access-list session captiveportal
user alias cp-redirect svc-https permit
user any svc-http dst-nat 8080
user any svc-https dst-nat 8081
```

## Web Client Configuration with Proxy Script

If the web client proxy configuration is distributed through a proxy script (a `.pac` file), you need to configure the **captiveportal** policy to allow the client to download the file. Note that in order to modify the **captiveportal** policy, you must have the PEFNG license installed in the managed device.

To allow clients to download proxy script via the WebUI:

1. Login to the Mobility Master.
2. Edit the **captiveportal** policy by navigating to the **Configuration > Roles & Policies > Policies** page in the **Managed Network** node hierarchy.
3. Select the Policy and add a new rule with the following values:
  - **Source** is user.
  - **Destination** is host.
  - **Host IP** is the IP address of the proxy server.
  - **Service** is `svc-https` or `svc-http`.
  - **Action** is permit.
4. Click **Submit** to add the rule.
5. Click **Pending Changes**.
6. In the **Pending Changes** window, select the check box and click **Deploy changes**.

To allow clients to download proxy script via the command-line interface, access the CLI in config mode and issue the following commands:

```
(host) [md] (config) #ip access-list session captiveportal
  user alias mswitch svc-https permit
  user any tcp port dst-nat 8088
  user host ipaddr svc-https permit
  user any svc-http dst-nat 8080
  user any svc-https dst-nat 8081
```

## Personalizing the Captive Portal Page

The following can be personalized on the captive portal page:

- Captive portal background
- Welcome text
- Acceptance Use Policy

Starting with ArubaOS 8.0, Reply-Message that is returned by RADIUS server for a Captive Portal Authentication can be customized using the Standard Radius attribute **reply-Message** VSA.

The background image and text should be visible to users with a browser window on a 1024 by 768 pixel screen. The background should not clash if viewed on a much larger monitor. A good option is to have the background image at 800 by 600 pixels, and set the background color to be compatible. The maximum image size for the background can be around 960 by 720 pixels, as long as the image can be cropped at the bottom and right edges. Leave space on the left side for the login box.



---

Captive Portal profile have few configurations which are confined only to WebUI and there are no command line interface commands to perform some of the actions like uploading custom login or Welcome page, background images, logos, Acceptable Usage Policy (AUP) texts, and so on.

---

You can create your own web pages and install them in the managed device for use with captive portal.

1. Login to the Mobility Master.

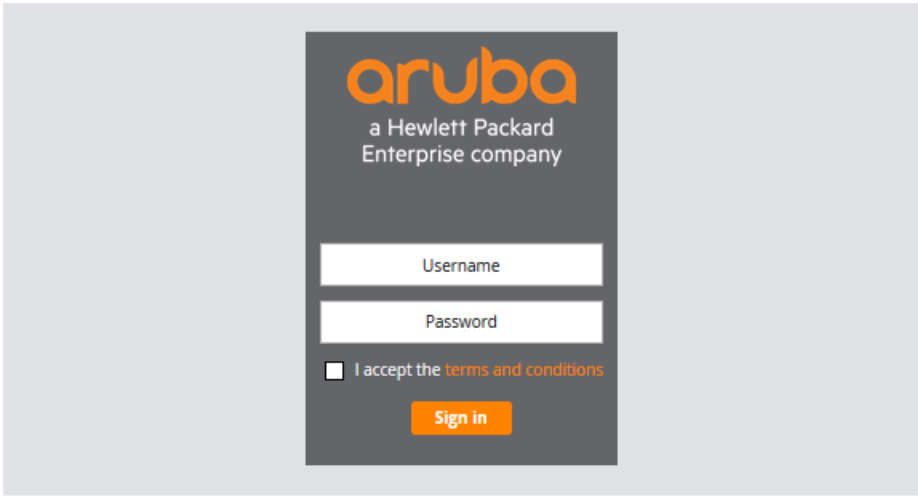
2. In the **Managed Network** node hierarchy, navigate to the **Configuration > Roles & Policies** page.
3. Select a role and click **Show Advanced View** in Roles > <rolename> table.
4. Click **Captive Portal**. Click **Internal captive portal with authentication** option.

**Roles** Policies Applications

No Captive Portal

**Captive Portal Options:**

Template Custom HTML



Click thumbnail above to edit

Redirect URL:

5. Click on the Thumbnail to edit the Templates. You can edit the logo, Box Color, Text Color, and Button Color. Click **Preview** the view the changes.

**Logo** Box Color Text Color Button Color

Logo selection:

None

Default Aruba logo

Custom

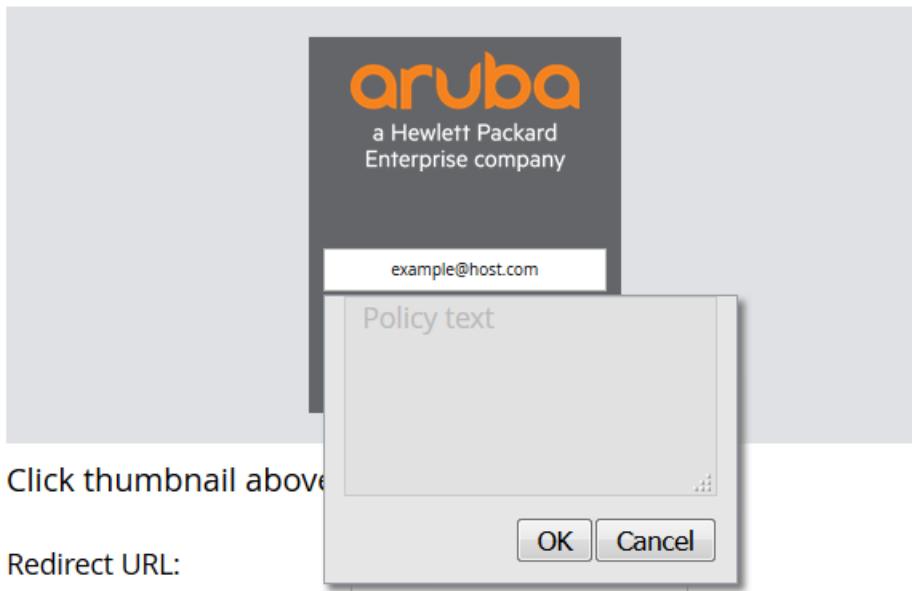
Filename:

6. Click **Submit** to save the changes.

- You can also change the AUP text using templates link in the **Captive Portal Options** window. Click on **accept the Terms and Conditions** option and the window to add **Policy Text** is displayed.

**Captive Portal Options:**

Template    Custom HTML



Click thumbnail above

Redirect URL:

- Click **Submit** to save the changes.




---

When the Terms and conditions link is clicked, the AUP text is displayed only if the AUP text was previously entered.

---

- To upload Login or Welcome page, perform the following steps using Custom HTML link in the **Captive Portal Options** window:
  - Click on Custom HTML link.

**Captive Portal Options:**

Template    Custom HTML

File for Login page:

Browse

Preview

File for Welcome page:

Browse

- To change the login page, browse for the file through the **File for Login Page** option.
  - To change the Welcome page, browse for the file through the **File for Welcome Page** option.
  - Before submitting the changes, ensure that the changes are accurate by clicking the **Preview** option.
- Similarly, you can customize the page for Internal Captive Portal with email registration and for Internal Captive portal, no auth or registration.
  - Click **Submit**.
  - Click **Pending Changes**.



13. In the **Pending Changes** window, select the check box and click **Deploy changes**.

## Customizing the Captive Portal Page for a Role

Captive Portal page can also be customized for a particular user role.

To customize the Captive Portal page for a role, perform the following steps:

1. Login to the Mobility Master.
2. In the **Managed Network** node hierarchy, navigate to **Configuration > Roles & Policies** and click **Roles** tab.
3. Select the role you want to customize the Captive Portal page for.
4. Select **Show Advanced View**.
5. Click **Captive Portal** tab in the **Roles ><role\_name>** table.
6. Click **Internal captive portal with email registration** option and the **Captive Portal Options** are displayed.
7. You can also customize the Captive Portal page while creating the virtual AP with option as Guest in the **Configuration > WLAN** options.
8. Click **Submit**.
9. Click **Pending Changes**.
10. In the **Pending Changes** window, select the check box and click **Deploy changes**.

## Creating Walled Garden Access

On the Internet, a walled garden typically controls a user's access to web content and services. The walled garden directs the user's navigation within particular areas to allow access to a selection of websites or prevent access to other websites.



---

The Walled Garden feature can be used with the PEFNG or PEFV licenses.

---

Walled garden access is needed when an external or internal captive portal is used. A common example could be a hotel environment where unauthenticated users are allowed to navigate to a designated login page (for example, a hotel website) and all its contents.

Users who do not sign up for Internet service can view "allowed" websites (typically hotel property websites). The website names must be DNS-based (not IP address based) and support the option to define wildcards.

HTTP or HTTPS proxy does not work when walled garden is implemented as a user-role using domain name ACL. For example, **user alias example.com any permit**.

When a user attempts to navigate to other websites not configured in the white list walled garden profile, the user is redirected back to the login page. In addition, the black listed walled garden profile is configured to explicitly block navigation to websites from unauthenticated users.

### In the CLI

This example configures a destination named Mywhite-list and adds the domain names, example.com and example.net to that destination. It then adds the destination name Mywhite-list (which contains the allowed domain names example.com and example.net) to the white list.

```
(host) [md] (config)# netdestination "Mywhite-list"  
(host) [md] (config)#name example.com  
(host) [md] (config)#name example.net
```

```
(host) [md] (config) #aaa authentication captive-portal default
```

```
(host) [md] (Captive Portal Authentication Profile "default")#white-list Mywhite-  
list
```

After you create the netdestination in using the CLI, perform the following steps in the WebUI:

### In the WebUI

1. Login to the Mobility Master.
2. In the **Managed Network** node hierarchy, navigate to **Configuration > Roles and Policies**.
3. Select **Policies** tab.
4. Click **+** to add a new policy.
5. Enter **Policy Name** and set the **Policy Type** as Session.
6. Select the newly created policy name and Click **+** to add a new rule.
7. Select Access Control as the **Rule Type** and click **OK**.
8. In the **New forwarding Rule** window:
  - a. Select the managed device's IP version, IPv4 or IPv6, from the **IP Version** drop-down list.
  - b. Enter the destination as **Alias**.
  - c. Click **+** for Destination Alias and select the destination, **Mywhite-list**.
9. Click **Submit**.
10. Navigate to **Configuration > Authentication > L3 Authentication**.
11. Select **Captive Portal Authentication Profile**.
12. To allow users to access a domain, enter the destination name that contains the allowed domain names in the **White List** field. This stops unauthenticated users from viewing specific domains such as a hotel website.

A rule in the white list must explicitly permit a traffic session before it is forwarded to the managed device. The last rule in the white list denies everything else.
13. To deny users access to a domain, enter the destination name that contains prohibited domain names in the **Black List** field. This prevents unauthenticated users from viewing specific websites.
14. Click **Submit**.
15. Click **Pending Changes**.
16. In the **Pending Changes** window, select the check box and click **Deploy changes**.

## Enabling Captive Portal Enhancements

ArubaOS introduces the following enhancements in Captive Portal:

- Location information such as AP name and AP group name have been included in the Captive Portal redirect URL. The following example shows a Captive Portal redirect URL that contains the AP name and the AP group name:

```
https://securelogin.example.com/cgi-  
bin/login?cmd=login&mac=00:24:d7:ed:84:14&ip=10.15.104.13&ssid=example-test-  
tunnel&apname=ap135&apgroup=example&url=http%3A%2F%2Fwww%2Eespncriinfo%2Ecom%2F
```

- A new option **redirect-url** is introduced in the Captive Portal Authentication profile which allows you to redirect the users to a specific URL after the authentication is complete.
- Captive Portal Login URL length has been increased from 256 characters to 2048 characters.
- Support for "?" (question mark) inside the Captive Portal login URL has been added.

- A new field, **description** has been introduced in the **netdestination** and **netdestination6** commands to provide a description about the netdestination up to 128 characters long.
- Support for configuring Whitelist in Captive Portal has been introduced.

The Captive Portal enhancements are available on Tunnel and Split-Tunnel forwarding modes.

## Configuring the Redirect-URL

You can configure the Captive Portal redirect URL using the following commands:

```
(host) [md] (config) # aaa authentication captive-portal REDIRECT
(host) [md] (Captive Portal Authentication Profile "REDIRECT") #redirect-url <absolute-URL>
```

Example:

```
(host) [md] (config) # aaa authentication captive-portal REDIRECT
(host) [md] (Captive Portal Authentication Profile "REDIRECT") #redirect-url https://test-
login.php
```

## Configuring the Login URL

You can configure a Captive Portal login URL up to 2048 characters using the following commands:

```
(host) [md] (config) # aaa authentication captive-portal LOGIN
(host) [md] (Captive Portal Authentication Profile "LOGIN") #login-page "https://clearpass-
dev1.dev.arubademo.net/guest/aos8_self-reg.php?_browser=1"
```




---

You can configure the login URL with "?" (question mark) character in it provided the URL containing the question mark is within the double quotes.

---

## Defining Netdestination Descriptions

You can provide a description (up to 128 characters) for the netdestination using the CLI.

Use the following commands to provide description for an IPv4 netdestination:

```
(host) [md] (config) #netdestination Local-Server
(host) [md] (config-dest) #description "This is a local server for IPv4 client registration"
```

Use the following commands to provide description for an IPv6 netdestination:

```
(host) [md] (config) #netdestination6 Local-Server6
(host) [md] (config-dest) #description "This is a local server for IPv6 client registration"
```

The following command displays the details of the specified IPv4 netdestination in the managed device:

```
(host) (config-dest) #show netdestination local-server6
```

```
Name: local-server6
Description: This is a local server for IPv6 client registration
Position  Type  IP addr  Mask-Len/Range
-----  -
1         name  ::9      yahoomail
2         name  ::a      mycorp
3         name  ::b      cricinfo
```

The following command displays the details of the specified IPv6 netdestination in the managed device:

```
(host) (config-dest) #show netdestination Local-Server6
```

```
Local-Server6 Description: This is a local server for IPv6 client registration
-----
Position  Type  IP addr  Mask-Len/Range
-----  -
1         name  0.0.0.1  yahoomail
2         name  0.0.0.2  mycorp
```

```
3          name 0.0.0.3  cricinfo
```

## Configuring a Whitelist

You can now configure a Whitelist in Captive Portal using the CLI.

### Configuring the Netdestination for a Whitelist:

Use the following commands to configure a netdestination alias for Whitelist:

```
(host) [md] (config) #netdestination whitelist
(host) [md] (config-dest) #description guest_whitelist
(host) [md] (config-dest) #name mycorp
```

### Associating a Whitelist to Captive Portal Profile

Use the following CLI commands to associate a whitelist to the Captive profile:

```
(host) [md] (config) #aaa authentication captive-portal CP_Profile
(host) [md] (Captive Portal Authentication Profile "CP_Profile") #white-list whitelist
```

### Applying a Captive Portal Profile to a User-Role

Use the following commands to apply the Captive Portal profile to a user-role:

```
(host) [md] (config) # user-role guest_role
(host) [md] (config-submode) #access_list logon-control
(host) [md] (config-submode) #access_list captiveportal
(host) [md] (config-submode) #captive-portal CP_Profile
```

### Verifying a Whitelist Configuration

Use the following commands to verify the whitelist alias in the managed device:

```
(host) (config) #show netdestination whitelist
```

```
whitelist Description: guest_whitelist
-----
Position  Type  IP addr  Mask-Len/Range
-----  ----  -
1         name  0.0.0.6  mycorp
```

### Verifying a Captive Portal Profile Linked to a Whitelist

Use the following commands to verify the Captive Portal profile linked to the whitelist in the managed device:

```
(host) (config) #show aaa authentication captive-portal CP_Profile
```

```
Captive Portal Authentication Profile "CP_Profile"
-----
Parameter                               Value
-----
Default Role                             guest
Default Guest Role                       guest
Server Group                             default
Redirect Pause                           10 sec
User Login                               Enabled
Guest Login                              Disabled
Logout popup window                      Enabled
Use HTTP for authentication              Disabled
Logon wait minimum wait                  5 sec
Logon wait maximum wait                  10 sec
logon wait CPU utilization threshold     60 %
Max Authentication failures              0
Show FQDN                               Disabled
Use CHAP (non-standard)                  Disabled
```

Login page	/auth/index.html
Welcome page	/auth/welcome.html
Show Welcome Page	Yes
Add switch IP address in the redirection URL	Disabled
Adding user vlan in redirection URL	Disabled
Add a controller interface in the redirection URL	N/A
Allow only one active user session	Disabled
White List	whitelist
Black List	N/A
Show the acceptable use policy page	Disabled
Redirect URL	N/A

## Verifying Dynamic ACLs for a Whitelist

Use the following commands to verify the dynamically created ACLs for the whitelist in the managed device:

```
(host) (config)#show rights guest_role
```

```
Derived Role = 'guest_role'
Up BW:No Limit   Down BW:No Limit
L2TP Pool = default-l2tp-pool
PPTP Pool = default-pptp-pool
Periodic reauthentication: Disabled
ACL Number = 79/0
Max Sessions = 65535
Captive Portal profile = CP_Profile
```

```
access-list List
```

```
-----
Position  Name                               Location
-----  ----                               -
1         CP_Profile_list_operations
2         logon-control
3         captiveportal
CP_Profile_list_operations
-----
Priority  Source  Destination  Service  Action  TimeRange  Log  Expired  Queue  TOS  8021P
Blacklist Mirror  DisScan  ClassifyMedia  IPv4/6
-----  -
1         user    whitelist    svc-http    permit
4                                               Low
2         user    whitelist    svc-https   permit
4                                               Low
```

```
logon-control
```

```
-----
Priority  Source  Destination  Service  Action  TimeRange  Log  Expired  Queue  TOS  8021P
Blacklist Mirror  DisScan  ClassifyMedia  IPv4/6
-----  -
1         user    any          udp 68     deny
4                                               Low
2         any     any          svc-icmp   permit
4                                               Low
3         any     any          svc-dns    permit
4                                               Low
4         any     any          svc-dhcp   permit
4                                               Low
5         any     any          svc-natt   permit
4                                               Low
```

```
captiveportal
```

```
-----
Priority  Source  Destination  Service  Action  TimeRange  Log  Expired  Queue
TOS  8021P  Blacklist  Mirror  DisScan  ClassifyMedia  IPv4/6
```

Id	User	Service	Protocol	Port	Priority
1	user	controller	svc-https	dst-nat 8081 4	Low
2	user	any	svc-http	dst-nat 8080 4	Low
3	user	any	svc-https	dst-nat 8081 4	Low
4	user	any	svc-http-proxy1	dst-nat 8088 4	Low
5	user	any	svc-http-proxy2	dst-nat 8088 4	Low
6	user	any	svc-http-proxy3	dst-nat 8088 4	Low

Expired Policies (due to time constraints) = 0

## Verifying DNS Resolved IP Addresses for Whitelisted URLs

Use the following command to verify the DNS resolved IP addresses for the whitelisted URLs in the managed device:

```
(host) #show firewall dns-names ap-name <AP-name>
```

Example:

```
(host) [md] #show firewall dns-names ap-name ap135
```

Firewall DNS names

Index	Name	Id	Num-IP	List
0	bugzilla	10	1	0.0.0.0
1	cricinfo	9	0	
2	yahoo	1	0	
3	mycorp	6	1	1.1.1.1

## Bypassing Captive Portal Landing Page

An increasing number of user sessions in Captive Portal pre-authenticated role, repeatedly request the Captive Portal login page from the managed devices. This impacts the number of browser-based user login requests handled per second by the managed devices. This eventually delays the loading of the Captive Portal page and logging into Captive Portal. Most of the increased activities are from non-browser based applications running on smart phones and tablets.

When this feature is disabled, the managed devices sends 200 OK status code message to the now-browser based apps so that the apps stop sending repeated requests to the managed devices. This reduces the load of the **httpd** process on the managed devices. This feature is enabled by default and the default value of the parameter is 'disabled'.

You can enable this feature from the managed devices CLI. On enabling this feature, non-browser apps continue to request Captive Portal login page from the managed devices. This increases the load of the **httpd** process of the managed devices.

```
(host) [md] (config) #web-server profile
```

```
(host) [md] (Web Server Configuration) #bypass-cp-landing-page
```



The landing page contains the meta-refresh tag to reload the page using real browser applications.



---

ArubaOS 8.x does not support cluster in master controller mode.

---

Cluster is a combination of multiple managed devices working together to provide high availability to all the clients and ensure service continuity when a failover occurs.

ArubaOS 8.0 supports a 12-node cluster. The managed devices need not be identical and can be either L2-connected or L3-connected, with a mixed configuration. In case of failover, the client single sign-on (SSO) works for the L2-connected managed devices and the clients are de-authenticated for L3-connected managed devices in a cluster.

The client load is shared by all the managed devices and there is a larger roaming domain with smaller fault domain which helps in faster recovery.

All the managed devices that are part of a cluster are collectively known as cluster members. The workload of serving APs and clients is divided or partitioned among cluster members. All managed devices that are part of the cluster are managed by the same Mobility Master.

Clustering is based on keeping client processing, that is, signaling and traffic, anchored to a managed device regardless of which AP the client roams to, as long as the AP is within the control scope of the cluster. Since, the client is fixed at a given managed device, a single Basic Service Set (BSS) on an AP can now have clients that are anchored at multiple managed devices. Therefore, it is important to separate the management of AP from the management of client. Hence, the terms used are:

- AAC – AP Anchor Controller, a role given to a managed device from individual AP perspective.
- UAC – User Anchor Controller, a role given to a managed device from individual User perspective.

The terms AAC and UAC are only roles corresponding either a given AP or a given user respectively.

The cluster architecture uses the all-active and distributed reliability scheme as all cluster members are actively serving the load. One of the cluster members is elected as the cluster leader. Each cluster contains only one cluster leader. The cluster leader is elected from an operations perspective, however, all managed devices participating in the cluster have all the information to take over the leadership role, if required. Each managed devices in a cluster actively detects if the peer nodes within the cluster are reachable.

The objective of cluster is to provide high availability to all the clients and ensure service continuity when a failover occurs. It improves scalability, performance, and redundancy.

## Supported Platform

In ArubaOS 8.0, the cluster size can reach up to 12 managed devices to support very large campus deployments. It supports 7200 Series, 7000 Series, and VM platforms. Cluster setup supports a single cluster with a mix of 7200 Series and 7000 Series controllers. A mix of VM and hardware platforms are not supported. Remote Access points are supported in ArubaOS 8.0.

Cluster now supports all the cluster-related global shared memory on 7000 Series and VM controllers.

## Support for Heterogeneous Cluster

Listed below are some of the points to consider for cluster capacity (APs and clients) when the cluster has a heterogeneous managed device mix. For example, 7210, 7220, and 7240 managed devices.

- Total capacity of individual managed devices in the cluster, when redundancy is disabled.
- Half of the total capacity of individual managed devices in the cluster, when redundancy is enabled.
- The number of clusters are restricted to four when it involves a 7000 Series managed device.
- When 7200 Series managed devices are added to a cluster consisting of other 7000 Series managed devices, then the capacity of the 7200 Series managed devices is reduced to the maximum capacity of the 7000 Series managed devices that is currently part of the cluster.
- When 7000 Series managed devices is added to a cluster consisting of 7200 Series managed devices, then one of the following scenarios apply:
  - If there are more than three 7200 Series managed devices in the cluster, the 7000 Series managed devices will not be allowed to join the cluster.
  - If the current AP or station count on the 7200 Series managed devices is greater than the maximum AP or station capacity supported on the newly added 7000 Series managed devices, then the 7000 Series managed devices will not be allowed to join the cluster. To check if the 7000 Series managed devices were allowed to join the cluster, execute the **show lc-cluster group-membership** command.
  - If the current AP or station count on the 7200 Series managed devices is less than the maximum AP or station capacity supported on the newly added 7000 Series managed devices, then the capacity of the 7200 Series managed devices in the cluster will drop to the maximum capacity supported on the 7000 Series managed devices and the existing supported APs in the 7200 Series managed devices will not be impacted.
- **12-node cluster support** is applicable only for clusters consisting of 7200 Series managed devices.

---

Cluster supports VM only in homogenous mode. VM can be clustered only with other VM controllers and not with 7200 Series/7000 Series controllers.

---



---

Cluster is not supported in stand-alone controllers.

---

Even with a 12-node cluster, the maximum supported APs and client counts are limited to 10k and client count to 100k, respectively.

---

## RAP and IPv6 Support

With RAPs, tunnel mode VPN is configured and each AP is assigned an inner-IP or remote-IP. The same remote-IP or inner-IP is assigned to the RAPs on every managed device in the cluster. For RAPs, the size of cluster is restricted to four. Starting with ArubaOS 8.0, cluster setup supports both IPv4 and IPv6 clients and the IPv6 clients' sessions are also synchronized and continued after fail overs.

Starting from 8.0.1, to support RAP in cluster configuration, the CLI command, **lc-rap-pool** is used.



---

Only IPv6 clients are supported in a cluster. As we do not support IPv6 managed devices in a cluster, the APs communicating to managed devices over IPv6 is not supported.

---

## Cluster Load Balancing

To reduce excessive workload among managed devices, the cluster load balancing feature helps balance the stations among multiple User Anchor Controller (UAC). Thus, the transition of stations from one UAC to another is efficiently managed and the disruption to the existing station session is reduced.



If the system detects a distorted distribution of load, it load balanced the managed devices by changing the UAC of these clients. In this case, the load across all the managed devices are balanced in the cluster regardless of the type of platform.

For example, the threshold to trigger the load balancer is based on the individual platform capacity, and not the total cluster capacity. For example, if the threshold is 50%, and a cluster without redundancy has two 7240 managed devices, then the load balancer balances the load if any one of the managed devices reaches 16,000 clients. When the redundancy mode is enabled, the capacity of the cluster is reduced to half and only 8000 clients are considered to reach the threshold.

## Enhanced Multicast Proxy

Enhanced Multicast Proxy feature is an integral part of the cluster setup.

In traditional topology, if a multicast stream reaches more than one VLAN, a client that is attached to a BSS which has VLAN pool configured with both VLANs, receives more than one copy of the stream. In cluster, multicast is configured in only one VLAN and only one stream is seen by the managed devices and clients.

Managed device acts as a multicast proxy for all the wireless clients connected to it and the managed device's subscription to multicast stream is done through a single VLAN. Hence, only one copy of the multicast stream will be delivered to a client.



---

Clustering supports only IGMP proxy.

---

When IGMP proxy is enabled, client reports reach UAC and then, UAC transfers the subscription information to AP Anchor Controller (AAC) . Both managed devices (AAC and UAC) will proxy for clients in the uplink multicast VLAN.

APs are anchored on AAC and users on UAC. When an AP boots, it establishes tunnel with the AAC. The same tunnel is used for UAC traffic as well. When a client comes up, the AP determines its UAC and establishes a tunnel to the UAC. When the client roams from one AAC to another, protocol-independent Multicast (PIM) detects this roaming through STA (station) channel and deletes the client's multicast subscriptions from the old AAC and adds them to the new AAC. To perform this, a cluster proxy table that stores per-client subscriptions is maintained in the UAC.

If a multicast stream is sourced from a wireless station, the managed device forwards the stream to the multicast router through the VLAN, where the client is located. The downstream is still from the multicast router to each managed device in the cluster through the configured VLAN for multicast proxy operation. If the two VLANs are the same, the proxy on the UAC of the sourcing client will not receive the stream from the multicast router.

## Session State Synchronization

This feature resolves all issues regarding seamless roaming, service availability, and high availability.

Session synchronization feature ensures that service continuity is achieved for clients when failover occurs without the clients realizing that the managed device was down. The objective of the cluster is to provide high availability to all the clients and ensure service continuity when a failover occurs.

Only sessions which are HIGH value are synchronized, for example, FTP, UCC, and DPI modified sessions. And the session synchronization is supported only if the cluster nodes are L2 connected.

Synchronization for load balancing (REDUNDANCY OFF) is a necessary feature. In an existing cluster, when new managed devices are added and the existing managed devices have load more than the threshold, the load balancer ensures that traffic from UACs that have more load are redirected to the new managed device. In this

scenario, synchronization of the sessions for these users are performed before the load balancer switches the users from other UACs to ensure reliability.



---

A maximum of 10 sessions per client is supported. Session sync is now supported for IPv6 clients and dual stack.

---

Session synchronization is useful in two different scenarios:

- When Redundancy is OFF — When redundancy mode is turned off, standby copy is not created for an AP or the client for failover protection. As part of load balancing, prior to planned UAC switchover, sessions are synchronized to new UAC.
- When Redundancy is ON — When redundancy mode is turned on, the system will assign standby managed device for all APs and clients. The sessions are synchronized to standby UACs.

## Authorization Server Interaction

Cluster supports redundancy for both APs and clients. ACLs or Roles are referred with names instead of IDs. It will keep ACLs/roles in sync across cluster members and AP datapath as well.

User Anchor Controller (UAC) is the role given to a managed device from individual user perspective. UAC handles all the wireless client traffic, including association/disassociation notification, authentication, and all the unicast traffic between managed device and the client. UAC is used to ensure that the managed device remains the same within the cluster when the wireless clients roam between APs.

Standby Controller (S-UAC) is the role given to the managed device if a user fails over to this managed device when Active UAC (A-UAC) is down.

The Authorization module authenticates clients on A-UAC and sets the A-UAC IP address as NAS-IP. The external RADIUS server sets the NAS-IP as the A-UAC IP in the client database. This NAS-IP is used later to change the client's state or attributes. However, if the client changes its UAC, the authentication server is not updated and hence can affect the transactions initiated by the authorization server. To resolve this issue, virtual-IP and VLAN are configured in each node in the cluster.

## AP Fail Over to Different Cluster

Starting from ArubaOS 8.0, an AP will be able to fail over between clusters. Redundancy across geographically separated data centers are supported. An AP terminates to an AAC in a cluster. If a member in the cluster fails, then AP will fail over to the standby AAC in the same cluster. If the AP is unable to establish communication to any of the members in the first cluster, then it will terminate at another cluster setup in the backup data center. It will terminate only if the other cluster member's IP is provided in the AP system profile as backup-LMS.

For example, a cluster with four managed devices is deployed in the West Coast data center. Similarly, a cluster with four managed devices is deployed in the East Coast data center. An AP is configured to have a primary termination to West Coast data center and backup to East Coast data center. If a managed device fails in the West Coast data center, then the AAC will move to another managed device in the same data center. However, if the entire West Coast data center is inaccessible to the AP, then it will fail over to the East Coast data center.

## AP-Move

This feature enables an end-user to move a specific AP from the current managed device to a target managed device. The **ap-move** command reassigns an AP or AP group to any managed device. When an end-user wants to move some specific APs to other managed device without changing any configuration or if there is no fail

over/rebootstrap configuration between the current managed device and the target managed device, the **ap-move** command can be used to move a specific AP to a specific assigned managed device.

**ap-move** can be executed in the following setups:

- Same cluster group — **ap-move** can only be executed on a cluster's managed device leader.
- Same High Availability (HA)— this command is executed on the HA-Active node and the AP will fail over to HA standby.
- Normal topology — In a non-cluster setup, **ap-move** can be executed on the node to move an AP from the current managed device.

## In the CLI

If cluster is enabled, the System Access Point monitor (SAPM) process will check whether the current node is the cluster leader. If not, an error is displayed and the cluster leader IP address is provided to the end-user, then the end-user can execute the command in the correct managed device.



---

Currently, **apmove** and **ap-move** are two different commands. The **ap-move** command is used for HA while the **apmove** is used for same cluster group and non-cluster setup.

---

**ap-move** command is executed as follows:

```
(host) [mynode] (config) #apmove <ap-mac> <target-ip>
(host) [mynode] (config) #apmove <ap-group/all> <source-ip> <target-ip>
```

Parameter	Description
ap-mac	Specific AP.
ap-group/all	APs in specific group or all APs in the specific managed device.
source-ip	Specific managed device on which the specific APs are.
target-ip	Specific managed device to which the APs will be move.

## Cluster Configuration

This section describes the procedure for setting up a cluster using the CLI.

### In the CLI

Execute the following commands to set up a cluster in ArubaOS 8.0:

1. To create a managed device:

```
(host) [mynode] (config) #configuration node /md/cluster
```

2. To change the configuration node:

```
(host) [mynode] (config) #change-config-node /md/cluster
```

3. To ensure that the common profiles such as SSID, VAP, and AAA profiles configured in /managed device/cluster are consistent:

```
(host) [mynode] (config) #configuration device 00:1a:1e:02:04:88 device-model A7210 /md/cluster
```

4. All managed devices in the cluster need to be time synchronized. Hence, it is recommended to have an NTP server in a cluster setup. To configure an NTP server:

```
(host) [cluster] (config) #ntp server <ip address> iburst
(host) [cluster] (config) #ntp authentication-key 1 md5 <password>
```

5. To configure the cluster group profile in Mobility Master:

```
(host) [cluster] (config) #lc-cluster group-profile 6NodeCluster
```

6. To add the managed devices to the group profile:

---

The switch IP of the managed device is used as the IP address in the following configuration. The APs termination point should also be set to the switch IP of the managed device. The LMS-IP for the AP in the AP system profile becomes the active-AAC (A-AAC) for the AP.

---



```
(host) [cluster] (Classic Controller Cluster Profile "6NodeCluster ") #controller
10.16.116.3
(host) [cluster] (Classic Controller Cluster Profile "6NodeCluster ") #controller
10.15.116.4
(host) [cluster] (Classic Controller Cluster Profile "6NodeCluster ") #controller
10.15.116.5
(host) [cluster] (Classic Controller Cluster Profile "6NodeCluster ") #controller
10.15.116.8
(host) [cluster] (Classic Controller Cluster Profile "6NodeCluster ") #controller
10.15.116.9
(host) [cluster] (Classic Controller Cluster Profile "6NodeCluster ") #controller
10.15.116.10
(host) [cluster] (Classic Controller Cluster Profile "6NodeCluster ") #redundancy
```



---

The **IP address** is a mandatory field and the **priority, mcast, VLAN, VRRP IP** and **VRRP VLAN** are optional fields.

---

7. In Mobility Master, apply the configuration to managed devices:

```
(host) [cluster] (Classic Controller Cluster Profile "6NodeCluster ") #write memory
Saving Configuration...
Partial configuration for /md/cluster
```

8. Configure the group-membership on each managed devices. If you have nodes only under a node-path that forms a cluster, then execute the command on that node-path [00:1a:1e:02:04:88].

```
(host) [00:1a:1e:02:04:88] (config) #lc-cluster group-membership 6NodeCluster
(host) [00:1a:1e:02:04:88] (config) #write memory
```

9. On each managed device, check the cluster status:

```
(host) #show lc-cluster group-membership
```

10. To ensure the correct working of client SSO upon failover, managed devices in the cluster have to be L2-connected. The following command shows the status of L2/L3 connectivity in cluster.

```
(host) #show lc-cluster vlan-probe status
```

11. Optionally, on the managed devices, exclude certain VLANs for the VLAN probing algorithm.

```
(host) (config) #lc-cluster exclude-vlan <vlan-number>
```

12. After removing the VLANs using the previous command, run the VLAN probing algorithm again.

```
(host) [cluster] (config) #lc-cluster start-vlan-probe
```

## Basic Show Commands

Use the following **show** commands to ensure that the cluster configuration is working as expected:

1. Check the cluster status on each managed device:

```
(host) #show lc-cluster group-membership
```

2. View the status of the VLAN probing algorithm, which runs automatically between every pair of nodes in cluster:  

```
(host) #show lc-cluster vlan-probe status
```
3. View the heartbeat status:  

```
(host) # show lc-cluster heartbeat counters
```
4. View the active/standby AP load distribution within cluster for an AP:  

```
(host) # show lc-cluster load distribution ap
```
5. View the active/standby client load distribution within cluster for a client:  

```
(host) # show lc-cluster load distribution client
```
6. View the list of APs in standby mode on managed devices:  

```
(host) # show ap standby
```
7. View the list of users in standby mode on managed devices:  

```
(host) # show user-table standby
```
8. View the list of users in datapath in standby mode on managed devices:  

```
(host) # show datapath user standby
```
9. View the A-UAC and the S-UAC for any given client. This command can be run on any managed device that is part of the cluster:  

```
(host) # show aaa cluster essid <ssid name> mac <client mac address>
```
10. Collect the cluster-related debug information from managed devices:  

```
(host) #show cluster-tech-support </flash/config/outfile>
```
11. Collect the cluster-related debug information from an AP:  

```
(host) #show ap cluster-tech-support ap-name <ap-name> </flash/config/ap outfile>
```

## In the WebUI

Configuration of cluster in the WebUI involves two major steps:

- a. Create a cluster profile.
- b. Attach the created profile to the cluster group membership.

Perform the following steps to add a cluster profile:

1. In a **Managed Network** node hierarchy, navigate to **Configuration > System > Profiles** tab.
2. Expand **Cluster**, and click **Classic Controller Cluster**. The **Classic Controller Cluster Profile: New Profile** pane is displayed.
3. Click **+** in the **Classic Controller Cluster** profile.
4. Enter a name in the **Profile name** text box.
5. In **Member IP address**, click **+** and define the following fields, and then click **OK**.
  - Mandatory parameters
    - IP address — The IP address should be set to the switch IP of the managed device.
  - Optional parameters
    - Priority — This is used to influence the cluster leader election.
    - mcast VLAN — The VLAN used to subscribe the multicast traffic to the upstream multicast router.
    - VRRP IP — The IP used in order to service all requests initiated by external authentication servers such as CoA.
    - VRRP VLAN — The VLAN used in order to service all requests initiated by the external authentication servers such as CoA.
6. Click **Redundancy** to enable redundancy in the cluster.

7. Optionally, the **Active Client Load Re-Balance Threshold, Standby Client Load Re-Balance Threshold, Unbalance Threshold, Minimum Heartbeat Threshold in milliseconds** can be set. However, these parameters have default settings and Aruba strongly recommends using the default settings.



---

For **Minimum Heartbeat Threshold in milliseconds**, the default setting is based on the latency determined between each pair of managed devices and the cluster. It also depends on the connection type between managed device and distribution switch (single ethernet cable, or port channel, and so on).

---

8. Click **Save**.

Perform the following steps to attach the cluster profile to the cluster group membership.

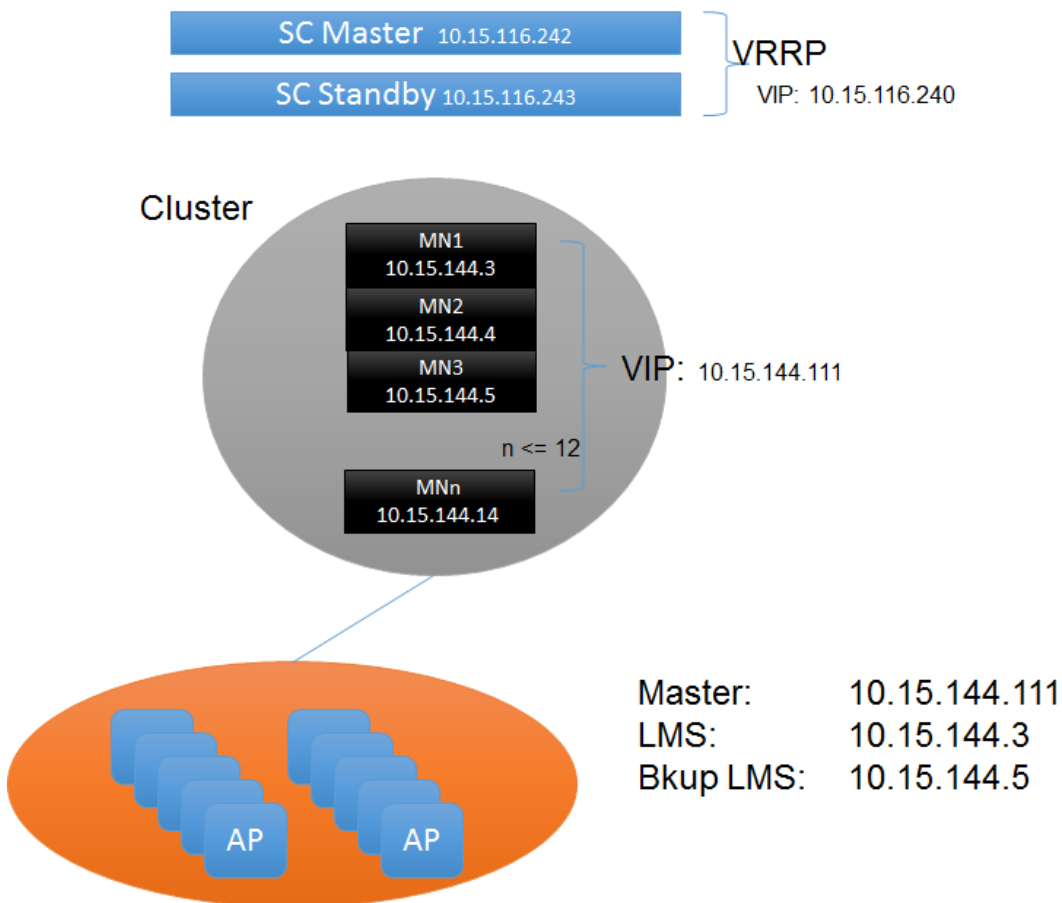
9. In the **Managed Network** node hierarchy, navigate to **Configuration > Services > Cluster Profile**.
10. Select the cluster profile from the **Cluster group-membership** drop-down list.
11. Click **Submit**.
12. Click **Pending Changes**.
13. In the **Pending Changes** window, select the check box and click **Deploy changes**.

## Cluster Deployment Scenarios

Cluster can be deployed in 4 different scenarios. The following section describes the guidelines for these different cluster deployment scenarios.

### Scenario 1: Cluster with Virtual IP Setup

In this scenario, an AP will perform a cluster failover to the S-AAC if the LMS (A-AAC) is down and the APs will perform internal rebootstrap if A-AAC and S-AAC are down at the same time. If the AP reboots on any of the nodes other than the LMS while the LMS is still down, it will contact the current VIP owner and will download the LMS and backup-LMS. It will also try to contact LMS but as the LMS is down, the AP will contact the backup-LMS and terminates on it.



Following are the guidelines to ensure for the successful deployment of the cluster in a Virtual IP :

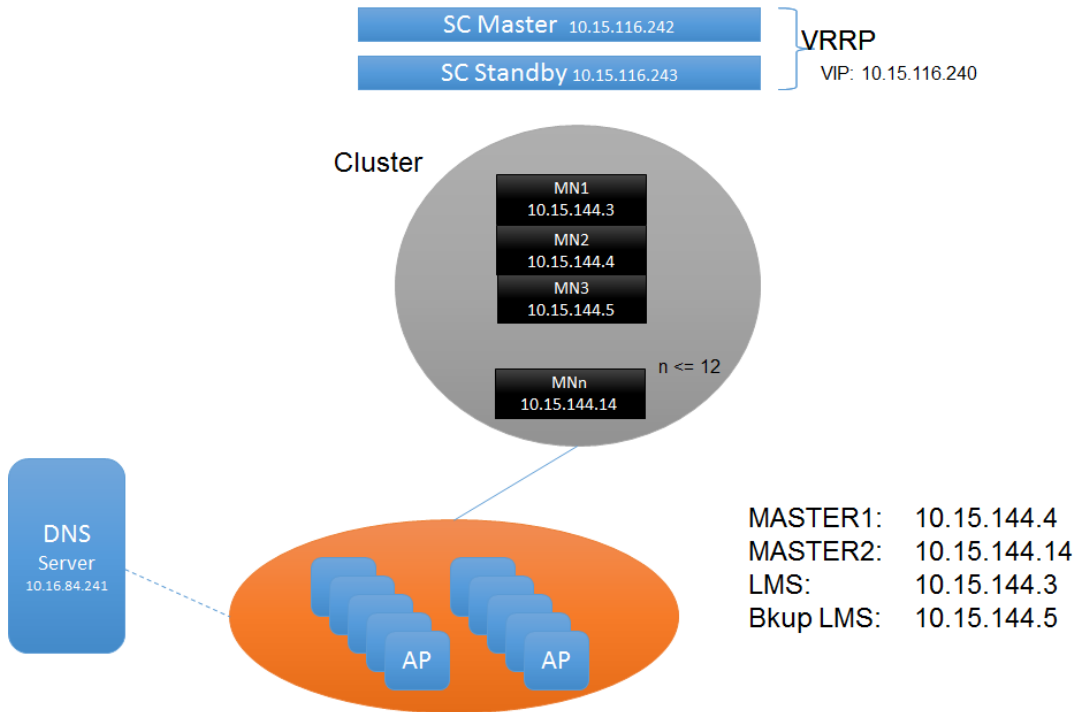
- APs' master must be configured as the VIP on the cluster nodes.
- LMS of the ap-group or ap-name should be the IP address of the cluster node and the backup-LMS should be the IP address of the other node in the same cluster.
- LMS preemption must be disabled.



Different AP's can have different LMS and backup-LMS configured as per the requirements.

## Scenario 2: Cluster with Multiple Master via DNS resolution

In this scenario, an AP will perform a cluster failover to the S-AAC if the LMS (A-AAC) is down and an AP will internally rebootstrap if the A-AAC and S-AAC are down at the same time and the AP tries to contact another node in the Cluster till it is unable to reach the entire node list of Cluster. If the AP reboots on any of the nodes other than the LMS, the AP contacts the master using multiple master list and downloads the LMS and backup-LMS. If the LMS is still down, the AP contacts the backup-LMS and terminates on it.



Following are the guidelines to ensure for the successful deployment of the cluster in a multiple master via DNS resolution setup:

- APs must get multiple masters using the DNS resolution.
- LMS of the ap-group or ap-name should be the IP address of the cluster node and the backup-LMS should be the IP address of the other node in the same cluster.
- LMS preemption must be disabled.



In a large deployment, Aruba recommends this configuration to avoid large failure domain.

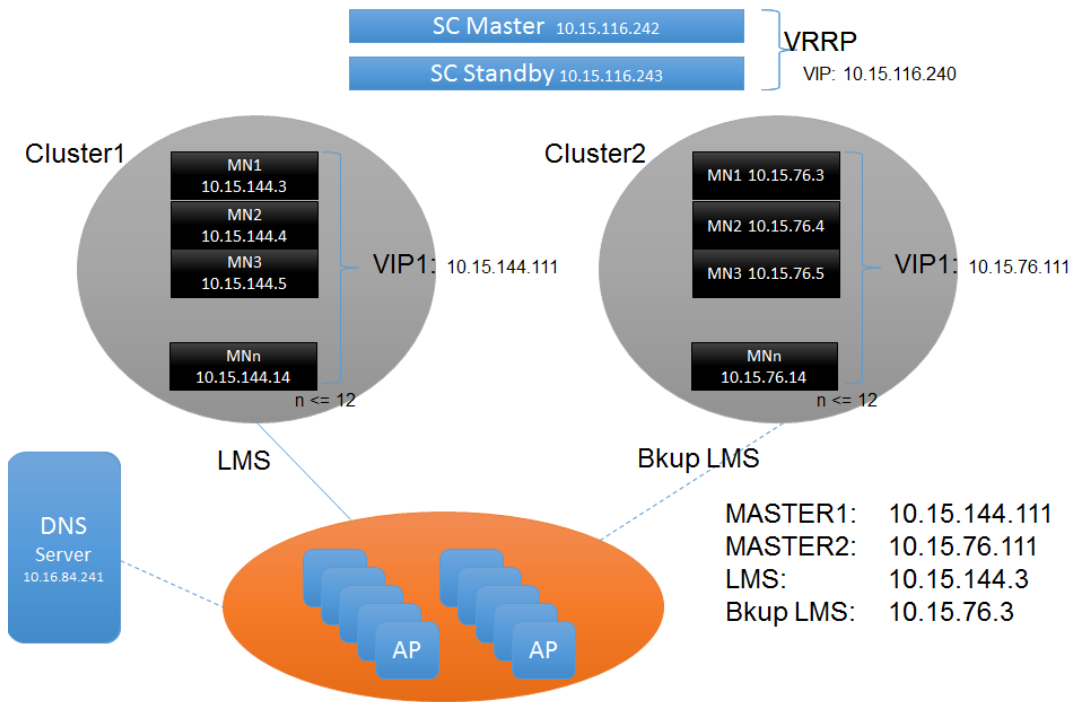
## Scenario 3: Cluster with Virtual IP via DNS Resolution Across Data Centers

In this scenario, when an A-AAC is down, the AP fails over to an S-AAC. An AP will internally rebootstrap if the A-AAC and S-AAC are down at the same time and the AP tries to contact another node in Cluster1 till it is unable to reach the entire node list of Cluster1. From the AP's perspective, if it is unable to reach Cluster1, AP will failover to backup-LMS.

If LMS preemption is enabled, APs will preempt to Cluster1 when the primary LMS node is up on Cluster1 and APs will remain on Cluster2 if the LMS preemption is disabled even though the Cluster1 is up.

If the AP reboots on the backup-LMS, it contacts the DNS server and gets two Virtual IPs. Then, the AP contacts the virtual IP of Cluster1 and download the LMS and backup-LMS from the node. If the LMS is down, the AP contact the backup-LMS and terminates on Cluster2.





Following are the guidelines to ensure for the successful deployment of the cluster with Virtual IP via DNS resolution across data centers:

- AP boots up and will have two masters (one from each cluster) resolved from the DNS server. The APs master is resolved to VIP of Cluster1 and VIP of Cluster2.
- LMS of the ap-group or ap-name should be the IP address of the Cluster1 node and the backup-LMS should be the IP address of the other node in the Cluster2. That is, LMS of the ap-group or ap-name must be configured to the Cluster1 node and the backup-LMS should be configured to the Cluster2 node.



In a large deployment, Aruba recommends this configuration to avoid large failure domain.

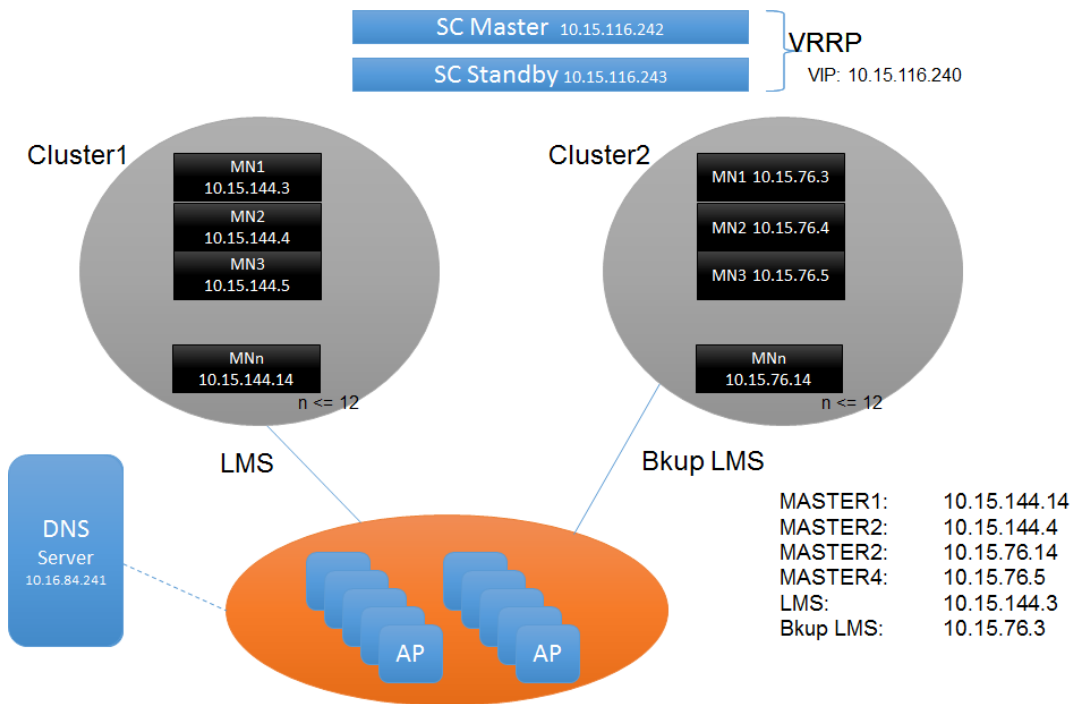
### Scenario 4: Cluster with Multiple Master via DNS Resolution Across Data Centers

In this scenario, when an A-AAC is down, the AP fails over to an S-AAC. An AP will internally bootstrap if the A-AAC and S-AAC are down at the same time and the AP tries to contact another node in Cluster1 till it is unable to reach the entire node list of Cluster1. From the AP's perspective, if it is unable to reach Cluster1, AP will failover to backup-LMS.

APs will terminate on the node of Cluster2 which is configured as a backup-LMS using legacy failover.

If LMS preemption is enabled, APs will preempt to Cluster1 when the primary LMS node is up on Cluster1 and APs will remain on Cluster2 if the LMS preemption is disabled even though the Cluster1 is up.

If the AP reboots on the backup-LMS or any other node on the Cluster 1 instead of the LMS, it contacts DNS nodes of Cluster1 and download the LMS and backup-LMS from it. However, if the nodes of the Cluster1 are down, the AP will download the configuration from Cluster2.



Following are the guidelines to ensure for the successful deployment of the cluster with multiple master via DNS resolution across data centers:

- AP boots up and will have four masters (two from each cluster) resolved from the DNS server. APs' master must be resolved to two nodes in Cluster one and two nodes in Cluster 2.
- LMS of the ap-group or ap-name should be the IP address of the Cluster1 node and the backup-LMS should be the IP address of the other node in the Cluster2. That is, LMS of the ap-group or ap-name must be configured to the Cluster1 node and the backup-LMS should be configured to the Cluster2 node.



Maximum of 10 entries are supported for master resolution. Combination of nodes from Cluster1 and Cluster2 can be used in DNS master resolution.

## Troubleshooting Cluster

This section provides commands that can be used to troubleshoot different scenarios in a cluster configuration.

The different control plane processes in the cluster are GSM manager (GSM), cluster manager (CM), Station Manager (STM), and AUTH. On the AP, the main modules are A-STM and ASAP (datapath).

### Common Scenarios

The following is a list of some common troubleshooting scenarios in cluster:

- [Cluster Formation Unsuccessful](#)
- [AP Rebootstrap](#)
- [Users are Unable to Connect to a Cluster](#)
- [Users are Getting De-authenticated](#)

### Cluster Formation Unsuccessful

All the managed devices in the cluster are collectively known as cluster members. The cluster formation is successful when all the managed devices in the cluster are CONNECTED to each other.

The following is a list of some of the reasons due to which a cluster formation is unsuccessful:

1. If the cluster group membership is not executed then the cluster formation fails.
2. If all the managed devices are not listed in cluster then the cluster formation fails.
3. If there is a connectivity issue and managed devices are not able to reach their peer.
4. If IPsec sa is not formed.

To check the status of the cluster formation, execute the **show lc-cluster group membership** command.

```
(host) [mynode] #show lc-cluster group-membership
Mon Dec 21 17:30:51.952 2015
Cluster Enabled, Profile Name = "6NodeCluster"
Redundancy Mode On
Active Client Rebalance Threshold = 50%
Standby Client Rebalance Threshold = 75%
Unbalance Threshold = 5%
Cluster Info Table
-----
Type IPv4 Address      Priority Connection-Type STATUS
-----
self    10.15.116.3          128          N/A ISOLATED (Leader)
peer    10.15.116.4          128          L3-Connected CONNECTED-FROM-SELF-DISCONNECTED-FROM-PEERS
peer    10.15.116.5          128          L3-Connected CONNECTED-FROM-SELF-DISCONNECTED-FROM-PEERS
peer    10.15.116.8          128          L3-Connected CONNECTED-FROM-SELF-DISCONNECTED-FROM-PEERS
peer    10.15.116.9          128          N/A SECURE-TUNNEL-NEGOTIATING
peer    10.15.116.10         128          N/A SECURE-TUNNEL-NEGOTIATING

DISCONNECTED
INCOMPATIBLE
DISCONNECTED-FROM-SELF-CONNECTED-FROM-PEERS",
CONNECTED-FROM-SELF-DISCONNECTED-FROM-PEERS",
SECURE-TUNNEL-NEGOTIATING
SECURE-TUNNEL-ESTABLISHED
CONNECTED
```

**Table 58:** Cluster state

State	Reason
INCOMPATIBLE	<p>This error can occur in the following scenario:</p> <ul style="list-style-type: none"> <li>● If two managed devices are running different ArubaOS versions, then a build string mismatch is found and the managed devices are not part of the cluster.</li> <li>● If there are already 4 managed devices including a RAP in a cluster, and if the user tries to add another managed device, RAP cluster limit reached error is displayed.</li> </ul>
DISCONNECTED	<p>This error can occur in the following scenario:</p> <ul style="list-style-type: none"> <li>● If none of the managed devices in the cluster are in the CONNECTED state.</li> <li>● If there is an issue with the physical connectivity between the managed devices in the cluster.</li> <li>● If one of the ports is an untrusted node.</li> </ul>
SECURE TUNNEL NEGOTIATION	<p>This status will be displayed for a very short period of time till the IPsec tunnel is set up. If the status persists, it indicates that there is an issue in the IPsec tunnel setup.</p>

State	Reason
CONNECTED FROM SELF DISCONNECTED FROM PEER	<p>This error can occur in the following scenario:</p> <ul style="list-style-type: none"> <li>MD1 and MD2 are connected. MD3 is later introduced in the cluster. MD1 and MD3 are connected but MD2 and MD3 are not connected.</li> </ul>

After the cluster moves to the CONNECTED state, check if it is L2-connected, where every VLAN on the peer is reachable as determined by vLAN probing. Use the following command to check the VLAN probing status:

```
(host) [mynode] #show lc-cluster vlan-probe status
```

Execute the VLAN probing algorithm on the managed device, if you have made some vlan changes to the distribution switch:

```
(host) [mynode] (config) #lc-cluster start-vlan-probe
```

## AP Rebootstrap

When the AP does not have a Standby AAC assigned, following could be the reasons for the AP rebootstrap:

1. Platform capacity — If the managed device has reached maximum exhaustion or it already has the maximum APs it can support.

To resolve this issue:

- Add another managed device or upgrade an existing managed device to support more number of APs.
- Rework on the network configuration.

2. Multiple managed devices are down – If an AAC goes down, the Standby Controller (S-UAC) is made the Active Controller (A-UAC). However, if the S-UAC also goes down, then the AP reboots.

To resolve this issue:

- Ensure that you make an appropriate selection of the distribution switch to handle the required scale.

## Users are Unable to Connect to a Cluster

The following is a list of some of the reasons due to which a user might be unable to connect to a cluster:

1. The AP and the managed device have different roles for the user.

Every user has an A-UAC and if the AP's perception of what the UAC for a user is different from the actual managed device's perception and if the managed device does not have this information regarding the user, then it rejects the user.

2. IPsec tunnel is not established.

If CPsec is enabled on the APs, then the APs are expected to have the IPsec tunnel established with all the managed devices in a cluster. If the IPsec tunnel is not established, the user cannot connect to a cluster.

3. There is incomplete AP configuration for an 802.1X client.

For 802.1X clients to connect, multicast key (mkey) has to go from AAC to UAC. If the mkey is not available in the UAC, the status will not be displayed and the user would be unable to connect. To check for incomplete AP configurations, execute the **show auth trace buff** command .

## Users are Getting De-authenticated

The following is a list of some of the reasons due to which a user might get de-authenticated:

1. Cluster failover — If a user is de-authenticated in a cluster, check if there was a cluster failover at the same time. For a managed node that is down, to check when it was last disconnected, use the **show lc-cluster heartbeat counters** command.

- In case a failover occurs when the managed devices are down, check if the managed devices are L2-connected using the **show lc-cluster vlan-probe status** command.
  - If the managed devices are L3-connected, fix the VLAN probe using the **lc-cluster exclude-vlan <vlan-number>** command.
2. If the managed devices are L2-connected and if the issue persists, check for [AP Rebootstrap](#).
  3. If the AP is not rebootstrapping and if there was no failover, contact support.

## Enabling Debug

In a cluster setup, a lightweight tracing mechanism has been added to collect debug information with minimal performance impact on the cluster.

In a 7200 Series managed device, the debug information gets collected in the flash1 partition of the managed device and can be used for future troubleshooting. In a 7000 Series managed device, there is no flash1 partition and a USB device is needed to collect this debug information, which can be used for future debugging or reporting of an issue.

Following traces could be turned on to collect debug information in the cluster:

```
(host) #gsm trace channel ap application stm
(host) #gsm trace channel ap application dds
(host) #gsm trace channel ap application cluster_mgr
(host) #gsm trace channel radio application stm
(host) #gsm trace channel radio application dds
(host) #gsm trace channel sta application stm
(host) #gsm trace channel sta application auth
(host) #gsm trace channel sta application dds
(host) #gsm trace channel sta application cluster_mgr
(host) #gsm trace channel mac_user application auth
(host) #gsm trace channel mac_user application dds
(host) #gsm trace channel mac_user application cluster_mgr
(host) #gsm trace channel ip_user application auth
(host) #gsm trace channel ip_user application dds
(host) #gsm trace channel user application auth
(host) #gsm trace channel user application dds
(host) #gsm trace channel sectun application dds
(host) #gsm trace channel sectun application cluster_mgr
(host) #gsm trace channel key_cache application auth
(host) #gsm trace channel key_cache application dds
(host) #gsm trace channel pmk_cache application stm
(host) #gsm trace channel pmk_cache application auth
(host) #gsm trace channel pmk_cache application dds
(host) #gsm trace channel rep_key application dds
(host) #gsm trace channel rep_key application cluster_mgr
(host) #gsm trace channel cluster application dds
(host) #gsm trace channel cluster application cluster_mgr
(host) #gsm trace channel bucket_map application stm
(host) #gsm trace channel bucket_map application auth
(host) #gsm trace channel bucket_map application dds
(host) #gsm trace channel bucket_map application cluster_mgr
(host) #gsm trace channel cluster_bss application dds
(host) #gsm trace channel cluster_bss application cluster_mgr
(host) #gsm trace channel cluster_aac application dds
(host) #gsm trace channel cluster_aac application cluster_mgr
(host) #gsm trace channel cluster_ap application dds
(host) #gsm trace channel cluster_ap application cluster_mgr
(host) #gsm trace channel bss application stm
(host) #gsm trace channel bss application auth
(host) #gsm trace channel bss application cluster_mgr
(host) #dds trace receive channel sta peer $peerIP
```

```
(host) #dds trace transmit channel sta peer $peerIP
(host) #dds trace receive channel ip_user peer $peerIP
(host) #dds trace transmit channel ip_user peer $peerIP
(host) #dds trace receive channel mac_user peer $peerIP
(host) #dds trace transmit channel mac_user peer $peerIP
(host) #dds trace receive channel key_cache peer $peerIP
(host) #dds trace transmit channel key_cache peer $peerIP
(host) #dds trace receive channel pmk_cache peer $peerIP
(host) #dds trace transmit channel pmk_cache peer $peerIP
(host) #dds trace receive channel bucket_map peer $peerIP
(host) #dds trace transmit channel bucket_map peer $peerIP
(host) #dds trace receive channel cluster_bss peer $peerIP
(host) #dds trace transmit channel cluster_bss peer $peerIP
(host) #dds trace receive channel cluster_sta peer $peerIP
(host) #dds trace transmit channel cluster_sta peer $peerIP
(host) #dds trace receive channel cac_usage peer $peerIP
(host) #dds trace transmit channel cac_usage peer $peerIP
(host) #dds trace receive channel cluster_aac peer $peerIP
(host) #dds trace transmit channel cluster_aac peer $peerIP
(host) #dds trace receive channel cluster_ap peer $peerIP
(host) #dds trace transmit channel cluster_ap peer $peerIP
(host) #ap debug stm-trace category all loglevel debug
(host) #aaa auth-trace loglevel debug
```

The MultiZone feature allows AP to terminate to multiple managed devices that reside in different zones. A zone is a collection of managed devices under a single administration domain. The zone can have a single managed device or a cluster setup.

Traditionally, one AP was managed by a single zone where the configuration was generated on a master controller and synchronized across all other local controllers. Starting from ArubaOS 8.0, MultiZone AP is supported and an AP can be managed by multiple zones. Different zones can have different configurations. The managed devices in different zones do not communicate with one another.

Initially, when the AP is booted up, the first zone it contacts is called the Primary Zone. When the AP boots up on a managed device, and the primary zone managed device configures the AP including the BSS, radio channel, radio power, and other features. The primary zone can configure MultiZone profiles to enable the MultiZone feature.

Data zone is the secondary zone that an AP connects to after receiving the MultiZone configuration from the primary zone. If there are MultiZone profiles configured and associated in the AP group or AP name profile of the primary zone, then the AP enters MultiZone state and starts connecting with the specified data zones. Only one MultiZone profile per ap-group or ap-name can be attached. The data zone managed device must be configured with the same AP group or AP name profile as the primary zone. When the AP connects to the data zone managed devices, there is a flag in the HELLO message indicating that the AP is connecting to the zone as a data zone. The data zone managed device then can configure additional BSSs.

The AP virtually connects to each data zone independently. Each data zone's network change or failure does not affect the management of an AP from other data zones. The data zone can configure the AP separately and the AP will apply each configuration. However, if the primary zone goes down, then all the data zones will be affected including the traffic on the data zone.

For example, the first zone has SSID-1, SSID-2 configured and has stand-alone setup, while the second zone has SSID-3, SSID-4 configured and has cluster setup. Then, the MultiZone AP receives both configurations and provides service for all the four SSIDs with no communication between the managed devices.

The MultiZone feature allows the client traffic of different Extended Service Set (ESS) to go to different managed devices into various zones without cross-contamination. The client traffic of the specific ESS is encrypted and tunneled directly from AP to the managed devices using the tunnel mode. All devices in the path including the primary managed device managing the AP are automatically secured. Client wireless frames are encrypted/decrypted for the corresponding SSID data zone managed device in the secure zone.

All the zones can have a maximum of 12 managed devices and 16 VAPs per radio and a maximum of 5 zones are supported including the primary zone. Only CPsec APs are supported for MultiZone configuration. Tunnel mode is the only supported Forward-Mode.

The primary zone and data zone managed devices do not require to be on the same layer 2 subnet, but, should be layer 3 reachable.



---

The data zone managed device cannot change the configuration that can affect other zone's BSSs like radio configurations.

---

The functional flow of the MultiZone AP is as follows:

- AP boots up and terminates on primary zone.
- Receives configuration from primary zone and apply.

- Simultaneously, it connects to each IP address of data zone configured in the MultiZone profile.
- Receives VAP configuration from data zone and apply.
- If common configuration like radio or channel is changed on primary zone, data zone needs to bootstrap to update.
- If the CPsec is enabled, each data zone managed device should have the AP appropriately white-listed.

## Configuration

The primary zone can configure MultiZone profiles to enable the MultiZone feature. The data zone APs are referred to as zone APs. In the data zone, the APs cannot be rebooted, provisioned, or upgraded. Only a tunnel mode virtual AP configuration is allowed.




---

The **AP-SYSTEM** profile should not be configured in the data zone Multizone AP Group.

---

### In the WebUI

To create a MultiZone profile:

1. In the **Managed Network** node hierarchy, navigate to **Configuration > System > Profiles > AP**.
2. Click **AP MultiZone**. **AP MultiZone profile: New Profile** is displayed.
3. Click **+** in **AP MultiZone profile** to add a new profile.
4. Enter the name of the profile in the **Profile Name** field.




---

The data zone managed device configuration should only include the VAP profile and AAA profile for the MultiZone AP Group.

---

5. Click **+** in the **Data zone controller IP** table.
  - a. Enter the name of the zone in the **Zone** field.
  - b. Enter the IP address in the **IP** field.
  - c. Enter the number of virtual APs in the **num\_vaps** field.
6. Click the **Enable/disable MultiZone** check box to enable or disable the MultiZone profile.
7. Click **Save**.
8. Click **Pending Changes**.
9. In the **Pending Changes** window, select the check box and click **Deploy changes**.

To attach or detach the profile to an ap-group:

1. In the **Managed Network** node hierarchy, navigate to **Configuration > AP Groups**.
2. Add the MultiZone profile to an AP Group.

### In the CLI

Execute the following commands to create a MultiZone profile, and set the data zone index, and controller-ip:

```
(host) [mm] (config)#ap multizone-profile newMZProfile
(host) [mm] (AP multizone profile "newMZProfile") #datazone 1 controller-ip 10.15.146.3 num-
vaps 3 num-nodes 4
(host) [mm] (AP multizone profile "newMZProfile") #datazone 2 controller-ip 10.15.144.3 num-
vaps 3 num-nodes 2
(host) [mm] (AP multizone profile "newMZProfile") #datazone 3 controller-ip 10.15.144.8 num-
vaps 3 num-nodes 2
(host) [mm] (AP multizone profile "newMZProfile") #datazone 4 controller-ip 10.16.84.10 num-
vaps 3 num-nodes 1
```



```
(host) [mm] (AP multizone profile "newMZProfile") #multizone-enable
(host) [mm] (AP multizone profile "newMZProfile") #write memory
```



---

If the data zone is in a cluster configuration, ensure that the number of num-nodes in the data zone should be more than or equal to the cluster node.

---

Execute the following commands to attach the profile to ap-group or ap-name:

```
(host) [mm] (config) #ap-group default
(host) [mm] (AP group "default") #ap-multizone-profile newMZProfile
(host) [mm] (AP group "default") #write memory
```

Wireless networks can use virtual private network (VPN) connections to further secure wireless data from attackers. Mobility Master can be used as a VPN concentrator that terminates all VPN connections from both wired and wireless clients.

This chapter describes the following topics:

- [Planning a VPN Configuration on page 338](#)
- [Working with VPN Authentication Profiles on page 342](#)
- [Configuring a Basic VPN for L2TP/IPsec on page 344](#)
- [Configuring a VPN for L2TP/IPsec with IKEv2 on page 349](#)
- [Configuring a VPN for Smart Card Clients on page 354](#)
- [Configuring a VPN for Clients with User Passwords on page 355](#)
- [Configuring Remote Access VPNs for XAuth on page 356](#)
- [Working with Remote Access VPNs for PPTP on page 358](#)
- [Working with Site-to-Site VPNs on page 358](#)
- [Working with VPN Dialer on page 365](#)

## Planning a VPN Configuration

The following VPN types can be configured on the Mobility Master or managed devices:

- **Remote access VPNs:** Remote access VPNs allow hosts, such as telecommuters or traveling employees, to connect to private networks (for example, a corporate network) over the Internet. Each host must run VPN client software, which encapsulates and encrypts traffic, then sends it to a VPN gateway at the destination network. The following remote access VPN protocols are supported by Mobility Master:
  - Layer-2 Tunneling Protocol over IPsec (L2TP/IPsec)
  - Point-to-Point Tunneling Protocol (PPTP)
  - XAUTH IKE/IPsec
  - IKEv2 with Certificates
  - IKEv2 with EAP
- **Site-to-site VPNs:** Site-to-site VPNs allow networks to connect to other networks, such as a corporate network. Unlike a remote access VPN, hosts in a site-to-site VPN do not run VPN client software. All traffic for the other network is sent and received through a VPN gateway, which encapsulates and encrypts the traffic.

Before enabling VPN authentication, you must configure the following:

- The default user role for authenticated VPN clients. See [Roles and Policies on page 367](#) for information about configuring user roles.
- The authentication server group used by the managed device to validate clients. See [Authentication Servers on page 180](#) for configuration details.



---

A server-derived role, if present, takes precedence over the default user role.

---

You then specify the default user role and authentication server group in the VPN authentication **default** profile, as described in the sections below.



ESP Tunnel Mode is the only supported IPsec mode of operation. Mobility Master does not support AH and Transport modes.

## Selecting an IKE protocol

Managed devices running ArubaOS 8.0 support both IKEv1 and IKEv2 protocols to establish IPsec tunnels. Though both IKEv1 and IKEv2 support the same suite-B cryptographic algorithms, IKEv2 is a simpler, faster, and more reliable protocol than IKEv1.

If your IKE policy uses IKEv2, you should be aware of the following caveats when configuring your VPN:

- Separate pre-shared keys cannot be used for each direction of an exchange; both peers must use the same pre-shared key.
- Mixed authentication between both pre-shared keys and certificates is not supported; each authentication exchange requires a single authentication type. For example, if a client authenticates with a pre-shared key, the managed device must also authenticate with a pre-shared key.
- IKEv2 Authentication Headers (AH) and IP Payload Compression Protocol (IPComp) are not supported.
- Non-Aruba devices can fragment the large IKE\_AUTH packets using the standards described in the **RFC 7383 – Internet Key Exchange Protocol Version 2 (IKEv2) message fragmentation** when the Aruba device acts as a responder and not as an initiator.

## Understanding Suite-B Encryption Licensing

Aruba managed devices support Suite-B cryptographic algorithms when the Advanced Cryptography (ACR) license is installed. [Table 59](#) describes the Suite-B algorithms supported by Mobility Master IKE Policies and IPsec tunnels. For further details on configuring a VPN to use Suite-B algorithms, see [Configuring a VPN for L2TP/IPsec with IKEv2 on page 349](#).

**Table 59:** Suite-B Algorithms Supported by the ACR License

IKE Policies	Suite-B for IPsec tunnels
hash: SHA-256-128, SHA-384-192	Encryption: AES-128-GCM, AES-256-GCM
Diffie-Hellman (DH) Groups: ECP-256, ECP-384	Perfect Forward Secrecy (PFS): ECP-256, ECP-384
Pseudo-Random Function (PRF): HMAC_SHA_256, HMAC_SHA_384	—
Suite-B certificates: ECDSA-256, ECDSA-384	—



The ArubaOS hardware supports IKE Suite-B AES-128-GCM and AES-256-GCM encryption. The ArubaOS software performs the IKE Suite-B Diffie-Hellman and Certificate-based signature operations, and hash, PFS, and PRF algorithm functions.

The following VPN clients support Suite-B algorithms when establishing an L2TP/IPsec VPN:

**Table 60:** Client Support for Suite-B

Client Operating System	Supported Suite-B IKE Authentication	Supported Suite-B IPsec Encryption
<ul style="list-style-type: none"> <li>Windows client</li> </ul> <p><b>NOTE:</b> Windows client operating system includes Windows XP and later versions.</p>	<ul style="list-style-type: none"> <li>IKEv1 Clients using ECDSA Certificates</li> <li>IKEv1/IKEv2 Clients using ECDSA Certificates with L2TP/PPP/EAP-TLS certificate user-authentication</li> </ul>	<ul style="list-style-type: none"> <li>AES-128-GCM</li> <li>AES-256-GCM</li> </ul>

The Suite-B algorithms described in [Table 59](#) are also supported by Site-to-Site VPNs between Aruba managed devices, or between an Aruba managed device and a server running Windows 2008 or StrongSwan 4.3.

## Working with IKEv2 Clients

Not all clients support both the IKEv1 and IKEv2 protocols. Only the clients in [Table 61](#) support IKEv2 with the following authentication types:

**Table 61:** VPN Clients Supporting IKEv2

Windows Client	StrongSwan 4.3 Client	VIA Client
<ul style="list-style-type: none"> <li>Machine authentication with Certificates</li> <li>User name password authentication using EAP-MSCHAPv2 or PEAP-MSCHAPv2</li> <li>User smart-card authentication with EAP-TLS / IKEv2</li> </ul> <p><b>NOTE:</b> Windows clients using IKEv2 do not support pre-shared key authentication.</p> <p><b>NOTE:</b> Windows client operating system includes Windows 7 and later versions.</p>	<ul style="list-style-type: none"> <li>Machine authentication with Certificates</li> <li>User name password authentication using EAP-MSCHAPv2</li> <li>Suite-B cryptographic algorithms</li> </ul>	<ul style="list-style-type: none"> <li>Machine authentication with Certificates</li> <li>User name password authentication using EAP-MSCHAPv2</li> <li>EAP-TLS using Microsoft cert repository</li> </ul> <p><b>NOTE:</b> VIA clients using IKEv2 do not support pre-shared key authentication.</p>

## Support for VIA-Published Subnets

Starting from ArubaOS 8.0.1, a new feature is introduced in Mobility Master to support IKEv2 configuration (CFG\_SET) payload for VIA clients. This is in conformation with section 3.15 of [RFC 5996](#) applicable for route-based VPNs. This feature is disabled by default.

When this feature is enabled, managed devices can accept CFG\_SET message with the INTERNAL\_IP4\_SUBNET attribute type. When a managed device receives this message, which consists of an IP address and netmask, it adds an entry to the datapath route table that points to the VIA's inner IP address as the next-hop. The datapath route-cache for the VIA's inner IP will point to the tunnel endpoint associated with the VIA.

### Enabling Support for VIA-Published Subnets

You can enable the support for VIA-published subnets by using the CLI:

## In the CLI

To enable this feature in the Mobility Master, execute the following command:

```
(host)[mynode] (config) #crypto-local isakmp allow-via-subnet-routes
```

To disable the feature in the Mobility Master, execute the following command:

```
(host)[mynode] (config) #no crypto-local isakmp allow-via-subnet-routes
```

## Verifying Support for VIA-Published Subnets

To verify if the Mobility Master is configured to accept subnet routes from VIA clients, execute the following command:

```
(host)[mynode] #show crypto-local isakmp allow-via-subnet-routes  
Controller will accept subnet routes from via client
```

## Limitations

The following limitations are applicable to the CFG\_SET support feature for Mobility Master:

- This feature supports only IPv4
- This feature is only applicable with IKEv2

For details about how to configure and run VIA on Linux platform, refer to the *VIA 2.3.1 Linux Edition Release Notes*.

## Understanding Supported VPN AAA Deployments

If you want to simultaneously deploy various combinations of a VPN client, RAP-psk, RAP-certs, and CAP on the same controller, see [Table 62](#).

Each row in this table specifies the allowed combinations of AAA servers for simultaneous deployment. Configuration rules include the following:

- RAP-certs can only use LocalDB-AP.
- An RAP-psk and RAP-cert can only terminate on the same controller if the RAP VPN profile's AAA server uses Local-db.
- If an RAP-psk is using an external AAA server, the RAP-cert cannot be terminated on the same controller.
- Clients can use any type of AAA server, regardless of the RAP/CAP authentication configuration server.

**Table 62:** Supported VPN AAA Deployments

VPN Client	RAP psk	RAP certs	CAP
External AAA server 1	LocalDB	LocalDB-AP	CPsec-whitelist
External AAA server 1	External AAA server 1	Not supported	CPsec-whitelist
External AAA server 1	External AAA server 2	Not supported	CPsec-whitelist
LocalDB	LocalDB	LocalDB-AP	CPsec-whitelist
LocalDB	External AAA server 1	Not supported	CPsec-whitelist

## Working with Certificate Groups

The certificate group feature allows you to access multiple types of certificates on the same controller. To create a certificate group, use the following command:

```
(host) [node] (config) #crypto-local isakmp certificate-group server-certificate <server_cert-name> ca-certificate <ca_cert-name>
```

You can view existing certificate groups using:

```
(host) [node] #show crypto-local isakmp certificate-group
```

## Working with VPN Authentication Profiles

VPN Authentication profiles identify an authentication server, the server group to which the authentication server belongs, and a user-role for authenticated VPN clients. There are three predefined VPN authentication profiles: **default**, **default-rap**, and **default-cap**. These different profiles allow you to use different authentication servers, user roles, and IP pools for VPN, remote AP, and campus AP clients.



---

You can configure the **default** and **default-rap** profiles, but not the **default-cap** profile.

---

**Table 63:** *Predefined Authentication Profile settings*

Parameter	Description	default	default-rap	default-cap
Default Role for authenticated users	The role that is assigned to the authenticated users.	default-vpn-role	default-vpn-role	sys-ap-role 0
Maximum allowed authentication failures	The number of contiguous authentication failures before the station is blacklisted.	0 (feature is disabled)	0 (feature is disabled)	0 (feature is disabled)
Check certificate common name against AAA server	When enabled, this feature verifies that the certificate's common name exists in the server.	disabled	enabled	enabled

Parameter	Description	default	default-rap	default-cap
Export VPN IP address as a route	When enabled, this feature causes any VPN client address to be exported to OSPF using IPC.  <b>NOTE:</b> The <b>Framed-IP-Address</b> attribute is assigned the IP address as long as the any server returns the attribute. The <b>Framed-IP-Address</b> value always has a higher priority than the local address pool.	enabled	enabled	enabled
User idle timeout	The user idle timeout value for this profile. Specify the idle timeout value for the client in seconds. Valid range is 30-15300 in multiples of 30 seconds. Enabling this option overrides the global settings configured in the AAA timers. If this is disabled, the global settings are used.	disabled	N/A	N/A
PAN firewalls Integration	Requires IP mapping at Palo Alto Networks firewalls.	disabled	disabled	disabled

## In the WebUI

To modify the **default** VPN authentication profile via the WebUI:

1. In the **Mobility Master** node hierarchy, navigate to the **Configuration > System > Profiles** page.
2. In the **All Profiles** list, expand **Wireless LAN > VPN Authentication** and select the **default** VPN authentication profile.
3. From the **Default Role** drop-down list, select the default user role for authenticated VPN users. (For detailed information on creating and managing user roles and policies, see [Roles and Policies on page 367](#).)
4. (Optional) Set **Max Authentication failures** to an integer value. The default value is 0, which disables this feature.
5. (Optional) If you use client certificates for user authentication, select the **Check certificate common name against AAA server** check box to verify that the certificate's common name exists in the server. This parameter is enabled by default in the **default-cap** and **default-rap** VPN profiles, and is disabled by default on all other VPN profiles.
6. (Optional) Regardless of how an authentication server is contacted, the **Export VPN IP address as a route** option causes any VPN client address to be exported to OSPF using IPC. Note that the **Framed-IP-Address** attribute is assigned the IP address as long as any server returns the attribute. The **Framed-IP-Address** value always has a higher priority than the local address pool.
7. Enter a **User idle timeout** value, in seconds.

8. (Optional) Enabling **PAN Firewall Integration** requires IP mapping at Palo Alto Networks firewalls. (For more information about PAN firewall integration, see [Palo Alto Networks Firewall Integration on page 632.](#))
9. Click **Save**.
10. Click **Pending Changes**.
11. In the **Pending Changes** window, select the check box and click **Deploy Changes**.
12. In the **All Profiles** list, select the **Server Group** entry below the **Wireless LAN > VPN Authentication > Default** profile.
13. From the **Server Group** drop-down list, select the server group to be used for VPN authentication.
14. Click **Save**.
15. Click **Pending Changes**.
16. In the **Pending Changes** window, select the check box and click **Deploy Changes**.

## In the CLI

To configure VPN authentication via the command-line interface, access the CLI in config mode and issue the following commands:

```
(host) [mm] (config) #aaa authentication vpn default
(host) ^[mm] (VPN Authentication Profile "default") #cert-cn-lookup
(host) ^[mm] (VPN Authentication Profile "default") #clone <source>
(host) ^[mm] (VPN Authentication Profile "default") #default-role <role>
(host) ^[mm] (VPN Authentication Profile "default") #export-route
(host) ^[mm] (VPN Authentication Profile "default") #max-authentication-failures <number>
(host) ^[mm] (VPN Authentication Profile "default") #pan-integration
(host) ^[mm] (VPN Authentication Profile "default") #radius-accounting <server_group_name>
(host) ^[mm] (VPN Authentication Profile "default") #server-group <group>
(host) ^[mm] (VPN Authentication Profile "default") #user-idle-timeout <seconds>
```

## Configuring a Basic VPN for L2TP/IPsec

The combination of Layer-2 Tunneling Protocol and Internet Protocol Security (L2TP/IPsec) creates a highly-secure technology that enables VPN connections across public networks such as the Internet. L2TP/IPsec provides a logical transport mechanism on which to transmit PPP frames, tunneling, or encapsulation, so that the PPP frames can be sent across an IP network. L2TP/IPsec relies on the PPP connection process to perform user authentication and protocol configuration. With L2TP/IPsec, the user authentication process is encrypted using the Data Encryption Standard (DES) or Triple DES (3DES) algorithm.

L2TP/IPsec using IKEv1 requires two levels of authentication:

- Computer-level authentication with a preshared key to create the IPsec security associations (SAs) to protect the L2TP-encapsulated data.
- User-level authentication through a PPP-based authentication protocol using passwords, SecureID, digital certificates, or smart cards after successful creation of the SAs.




---

Note that only Windows 7 (and later versions), StrongSwan 4.3, and VIA clients support IKEv2. For additional information on the authentication types supported by these clients, see [Working with IKEv2 Clients on page 340.](#)

---

## In the WebUI

Use the following procedures in the WebUI to configure a remote access VPN for L2TP IPsec for clients using pre-shared keys, certificates, or EAP for authentication:

- [Defining Authentication Method and Server Addresses on page 345](#)
- [Defining Address Pools on page 345](#)
- [Enabling Source NAT on page 346](#)



- [Selecting Certificates on page 346](#)
- [Defining IKEv1 Shared Keys on page 346](#)
- [Configuring IKE Policies on page 347](#)
- [Setting the IPsec Dynamic Map on page 348](#)

## Defining Authentication Method and Server Addresses

The following procedure defines the authentication method and server addresses on Mobility Master:

1. Define the authentication method and server addresses.
2. In the **Mobility Master** node hierarchy, navigate to **Configuration > Services > VPN**.
3. Expand **IKEv1**.
4. To enable L2TP, select **Enabled** from the **L2tp** drop-down list (this is enabled by default).
5. Select an authentication method for IKEv1 clients. Currently, supported methods include:
  - Password Authentication Protocol (PAP)
  - Extensible Authentication Protocol (EAP)
  - Challenge Handshake Authentication Protocol (CHAP)
  - Microsoft Challenge Handshake Authentication Protocol (MSCHAP)
  - Microsoft Challenge Handshake Authentication Protocol version 2 (MSCHAPv2)
6. Click **Submit**.
7. Click **Pending Changes**.
8. In the **Pending Changes** window, select the check box and click **Deploy Changes**.
9. Expand **General Vpn**. Configure the IP addresses of the **Primary DNS Server**, **Secondary DNS Server**, **Primary WINS Server**, and **Secondary WINS Server** that are pushed to the VPN client.
10. Click **Submit**.
11. Click **Pending Changes**.
12. In the **Pending Changes** window, select the check box and click **Deploy Changes**.

## Defining Address Pools

The following procedure defines the pool from which the clients are assigned addresses:

1. In the **Mobility Master** node hierarchy, navigate to **Configuration > Services > VPN**.
2. Expand **General Vpn**.
3. In the **Address Pools** table, click + to open the **Add New Address Pool** section.
4. Specify the **Pool Name**, **Start address(ipv4/v6)**, and **End address(ipv4/v6)**.
5. Click **Submit**.
6. Click **Pending Changes**.
7. In the **Pending Changes** window, select the check box and click **Deploy Changes**.

### RADIUS Framed-IP-Address for VPN Clients

IP addresses are usually assigned to VPN clients from configured local address pools. However, the **Framed-IP-Address** attribute that is returned from a RADIUS server can be used to assign the address.

VPN clients use different mechanisms to establish VPN connections with Mobility Master, such as IKEv1, IKEv2, EAP, or a user certificate. Regardless of how the RADIUS server is contacted for authentication, the **Framed-IP-Address** attribute is assigned the IP address as long as the RADIUS server returns the attribute. The **Framed-IP-Address** value always has a higher priority than the local address pool.

## Enabling Source NAT

The following procedure enables source NAT on Mobility Master:

1. In the **Mobility Master** node hierarchy, navigate to **Configuration > Services > VPN**.
2. Expand **General Vpn**.
3. From the **Source-nat** drop-down list, select **Enabled** if the IP addresses of clients must be translated to access the network.
4. (Optional) If you enable source NAT, click the **NAT POOL** drop-down list and select an existing NAT pool.

## Selecting Certificates

If you are configuring a VPN to support machine authentication using certificates, define the IKE Server certificates for VPN clients using IKE. Note that these certificates must be imported into Mobility Master, as described in [Management Access on page 760](#).

1. In the **Mobility Master** node hierarchy, navigate to **Configuration > Services > VPN**.
2. Expand **General Vpn**.
3. From the **Server-certificate for VPN clients** drop-down list, select the server certificate for client machines.
4. Click **Submit**.
5. Click **Pending Changes**.
6. In the **Pending Changes** window, select the check box and click **Deploy Changes**.
7. If you are configuring a VPN to support clients using certificates, you must also assign one or more trusted CA certificates to VPN clients.
  - a. Expand **Certificates for VPN Clients**.
  - b. In the **CA Certificate Assigned for VPN-Clients** table, click + to open the **Add New Certificate** section.
  - c. Select a **CA certificate** from the drop-down list.
  - d. Click **Submit**.
  - e. In the **Certificate Groups for VPN-Clients** table, click + to open the **Add New Certificate** section.
  - f. Select a **Server certificate** and **CA certificate** from the respective drop-down list.
  - g. Click **Submit**.
  - h. Repeat steps **b** through **g** to add more certificates.
  - i. Click **Pending Changes**.
  - j. In the **Pending Changes** window, select the check box and click **Deploy Changes**.

## Defining IKEv1 Shared Keys

If you are configuring a VPN to support IKEv1 and clients using pre-shared keys, you can configure a global IKE key or IKE key for each subnet. Make sure that this key matches the key on the client.

1. In the **Mobility Master** node hierarchy, navigate to **Configuration > Services > VPN**.
2. Expand **Shared Secrets**.
3. In the **IKE Shared Secrets** table, click + to open the **Create IKE Group** section.
4. Enter the **Subnet** and **Subnet mask**. To make the IKE key global, enter 0.0.0.0 for both values.
5. Select the **Representation type** from the drop-down list.
6. Enter **Shared key** and repeat it in the **Retype shared key** field.
7. Click **Submit**.
8. Click **Pending Changes**.

9. In the **Pending Changes** window, select the check box and click **Deploy Changes**.

## Configuring IKE Policies

ArubaOS contains several predefined default IKE policies, as described in [Table 64](#). If you do not want to use any of these predefined policies, you can use the procedures below to delete a factory-default policy, edit an existing policy, or create your own custom IKE policy instead.



---

The IKE policy selections, along with any preshared key, must be reflected in the VPN client configuration. When using a third-party VPN client, set the VPN configuration on clients to match the choices made above. In case the Aruba dialer is used, these configurations must be made on the dialer prior to downloading the dialer onto the local client.

---

1. In the **Mobility Master** node hierarchy, navigate to **Configuration > Services > VPN**.
2. Expand **IKEv1**.
3. In the **IKEv1 Policies** table, click an existing policy to edit it, or click + to create a new policy.
4. In **Priority**, enter a priority number for this policy. Enter 1 for the configuration to take priority over the default setting.
5. From the **Enable Policy** drop-down list, select **Enabled** (default value) to enable the policy when it is saved.
6. From the **Encryption** drop-down list, select one of the following encryption types:
  - DES
  - 3DES
  - AES128
  - AES192
  - AES256
7. From the **Hash algorithm** drop-down list, select one of the following hash types:
  - MD5
  - SHA
  - SHA1-96
  - SHA2-256-128
  - SHA2-384-192
8. ArubaOS VPNs support client authentication using pre-shared keys, RSA digital certificates, or Elliptic Curve Digital Signature Algorithm (ECDSA) certificates. To set the authentication type for the IKE rule, from the **Authentication** drop-down list, select one of the following options:
  - Pre-Share (for IKEv1 clients using pre-shared keys)
  - RSA (for clients using certificates)
  - ECDSA-256 (for clients using certificates)
  - ECDSA-384 (for clients using certificates)
9. Diffie-Hellman is a key agreement algorithm that allows two parties to agree upon a shared secret, and is used within IKE to securely establish session keys. To set the Diffie-Hellman Group for the ISAKMP policy, from the **Diffie hellman group** drop-down list, select one of the following options:
  - Group 1: 768-bit Diffie-Hellman prime modulus group
  - Group 2: 1024-bit Diffie-Hellman prime modulus group
  - Group 14: 2048-bit Diffie-Hellman prime modulus group
  - Group 19: 256-bit random Diffie-Hellman ECP modulus group
  - Group 20: 384-bit random Diffie-Hellman ECP modulus group



---

Configuring Diffie–Hellman Group 1 and Group 2 types are not permitted if FIPS mode is enabled.

---

10. In **Lifetime**, enter a value in the range of 300-86400 seconds to define the lifetime of the security association. The default value is 7200 seconds.
11. Click **Submit**.
12. Click **Pending Changes**.
13. In the **Pending Changes** window, select the check box and click **Deploy Changes**.

### Setting the IPsec Dynamic Map

Dynamic maps enable IPsec SA negotiations from dynamically addressed IPsec peers. ArubaOS has a predefined IPsec dynamic map for IKEv1. If you do not want to use this predefined map, you can use the procedures below to edit an existing map or create your own custom IPsec dynamic map instead.

1. In the **Mobility Master** node hierarchy, navigate to **Configuration > Services > VPN**.
2. Expand **IKEv1**.
3. In **IKEv1 IPsec Dynamic Maps**, click an existing dynamic map to edit it or click **+** to create a new map.
4. In **Priority**, enter a priority number for this map. Negotiation requests for security associations try to match the highest-priority map first. If that map does not match, the negotiation request continues down the list to the next-highest priority map until a match is made.
5. In **Name**, enter a name for the dynamic map.
6. (Optional) Configure Perfect Forward Secrecy (PFS) settings for the dynamic peer by assigning a Diffie–Hellman prime modulus group. PFS group provides an additional level of security by ensuring that the IPsec SA key was not derived from any other key, and therefore, cannot be compromised if another key is broken. In the **PFS group** drop-down list, select one of the following groups:
  - Group 1: 768-bit Diffie–Hellman prime modulus group
  - Group 2: 1024-bit Diffie–Hellman prime modulus group
  - Group 14: 2048-bit Diffie–Hellman prime modulus group
  - Group 19: 256-bit random Diffie–Hellman ECP modulus group
  - Group 20: 384-bit random Diffie–Hellman ECP modulus group
7. In **Transforms**, select an existing transform to edit it, or click **+** to open the **New Transform** section.



---

To view current configuration settings for an IPsec transform-set, access the CLI and issue the command **crypto ipsec transform-set tag <transform-set-name>**.

---

8. From the **Encryption** drop-down list, select one of the following encryption types:
  - DES
  - 3DES
  - AES128
  - AES192
  - AES256
9. From the **Hash** algorithm drop-down list, select one of the following hash types:
  - MD5
  - SHA
  - SHA1-96
  - SHA2-256-128

- SHA2-384-192
10. In **Lifetime(seconds)**, enter a value in the range of 300-86400 seconds to define the lifetime of the security association for the dynamic peer. The default value is 7200 seconds.
  11. In **Lifetime(kilobytes)**, enter a value in kilobytes to define the lifetime of the security association for the dynamic peer.
  12. Click **Submit**.
  13. Click **Pending Changes**.
  14. In the **Pending Changes** window, select the check box and click **Deploy Changes**.

## In the CLI

To configure a remote access VPN for L2TP IPsec:

1. Define the authentication method and server addresses:

```
(host) [mynode] (config) #vpdn group l2tp
enable
client configuration {dns|wins} <ipaddr1> [<ipaddr2>]
```

2. Enable authentication methods for IKEv1 clients:

```
(host) [mynode] (config) vpdn group l2tp ppp authentication {cache-
securid|chap|eap|mschap|mschapv2|pap}
```

3. Create address pools:

```
(host) [mynode] (config) #ip local pool <pool> <start-ipaddr> <end-ipaddr>
```

4. Configure source NAT:

```
(host) [mynode] (config) #ip access-list session srcnatuser any any src-nat pool <pool>
position 1
```

5. If you are configuring a VPN to support machine authentication using certificates, define server certificates for VPN clients using IKEv1:

```
(host) [mynode] (config) #crypto-local isakmp server-certificate <cert>
```

6. If you are configuring a VPN to support IKEv1 Clients using pre-shared keys, you can configure a global IKE key by entering **0.0.0.0** for both the address and netmask parameters in the command below, or configure an IKE key for an individual subnet by specifying the IP address and netmask for that subnet:

```
(host) [mynode] (config) #crypto isakmp key <key> address <ipaddr|> netmask <mask>
```

7. Define IKE Policies:

```
(host) [mynode] (config) #crypto isakmp policy <priority>
encryption {3des|aes128|aes192|aes256|des}
version v1|v2
authentication {pre-share|rsa-sig|ecdsa-256|ecdsa-384}
group {1|2|19|20}
hash {md5|sha|sha1-96|sha2-256-128|sha2-384-192}
lifetime <seconds>
```

## Configuring a VPN for L2TP/IPsec with IKEv2

Only clients running Windows 7 (and later versions), StrongSwan 4.3, and Aruba VIA support IKEv2. For additional information on the authentication types supported by these clients, see [“Working with IKEv2 Clients on page 340.”](#)

## In the WebUI

Use the following procedures in the WebUI to configure a remote access VPN for IKEv2 clients using certificates.

- [Defining Authentication Method and Server Addresses on page 350](#)

- [Defining Address Pools on page 350](#)
- [Enabling Source NAT on page 350](#)
- [Selecting Certificates on page 350](#)
- [Configuring IKE Policies on page 351](#)
- [Setting the IPsec Dynamic Map on page 352](#)

## Defining Authentication Method and Server Addresses

The following procedure defines the authentication method and server addresses on Mobility Master:

1. In the **Mobility Master** node hierarchy, navigate to **Configuration > Services > VPN**.
2. Expand **IKEv2**.
3. In **EAP passthrough**, select the EAP passthrough for IKEv2 clients. The currently supported methods include:
  - EAP-TLS
  - EAP-PEAP
  - EAP-MSCHAPv2
4. Click **Submit**.
5. Click **Pending Changes**.
6. In the **Pending Changes** window, select the check box and click **Deploy Changes**.
7. Click **General Vpn** to expand it. Configure the IP addresses of the **Primary DNS Server**, **Secondary DNS Server**, **Primary WINS Server**, and **Secondary WINS Server** that are pushed to the VPN client.
8. Click **Submit**.
9. Click **Pending Changes**.
10. In the **Pending Changes** window, select the check box and click **Deploy Changes**.

## Defining Address Pools

The following procedure defines the pool from which the clients are assigned addresses:

1. In the **Mobility Master** node hierarchy, navigate to **Configuration > Services > VPN**.
2. Expand **General Vpn**.
3. In the **Address Pools** table, click + to open the **Add New Address Pool** section.
4. Specify the **Pool Name**, **Start address(ipv4/v6)**, and **End address(ipv4/v6)**.
5. Click **Submit**.
6. Click **Pending Changes**.
7. In the **Pending Changes** window, select the check box and click **Deploy Changes**.

## Enabling Source NAT

The following procedure enables source NAT on Mobility Master:

1. In the **Mobility Master** node hierarchy, navigate to **Configuration > Services > VPN**.
2. Expand **General Vpn**.
3. From the **Source-nat** drop-down list, select **Enabled** if the IP addresses of clients must be translated to access the network.
4. (Optional) If you enable source NAT, click the **NAT POOL** drop-down list and select an existing NAT pool.

## Selecting Certificates

If you are configuring a VPN to support machine authentication using certificates, define the IKE Server certificates for VPN clients using IKEv2. Note that these certificate must be imported into Mobility Master, as

described in [Management Access on page 760](#).

1. In the **Mobility Master** node hierarchy, navigate to **Configuration > Services > VPN**.
2. Expand **General Vpn**.
3. From the **Server-certificate for VPN clients** drop-down list, select the server certificate for client machines.
4. Click **Submit**.
5. Click **Pending Changes**.
6. In the **Pending Changes** window, select the check box and click **Deploy Changes**.
7. If you are configuring a VPN to support clients using certificates, you must also assign one or more trusted CA certificates to VPN clients.
  - a. Expand **Certificates for VPN Clients**.
  - b. In the **CA Certificate Assigned for VPN-Clients** table, click + to open the **Add New Certificate** section.
  - c. Select a **CA certificate** from the drop-down list.
  - d. Click **Submit**.
  - e. In the **Certificate Groups for VPN-Clients** table, click + to open the **Add New Certificate** section.
  - f. Select a **Server certificate** and **CA certificate** from the respective drop-down list.
  - g. Click **Submit**.
  - h. Repeat steps **b** through **g** to add more certificates.
  - i. Click **Pending Changes**.
  - j. In the **Pending Changes** window, select the check box and click **Deploy Changes**.

## Configuring IKE Policies

ArubaOS contains several predefined default IKE policies, as described in [Table 64](#). If you do not want to use any of these predefined policies, you can use the procedures below to delete a factory-default policy, edit an existing policy, or create your own custom IKE policy instead.



---

The IKE policy selections must be reflected in the VPN client configuration. When using a third-party VPN client, set the VPN configuration on clients to match the choices made above. In case the Aruba dialer is used, these configurations must be made on the dialer prior to downloading the dialer onto the local client.

---

1. In the **Mobility Master** node hierarchy, navigate to **Configuration > Services > VPN**
2. Expand **IKEv2**.
3. In the **IKEv2 Policies** table, click an existing policy to edit it, or click + to create a new policy.
4. In **Priority**, enter a priority number for this policy. Enter 1 for the configuration to take priority over the default setting.
5. From the **Enable Policy** drop-down list, select **Enabled** (default value) to enable the policy when it is saved.
6. From the **Encryption** drop-down list, select one of the following encryption types:
  - DES
  - 3DES
  - AES128
  - AES192
  - AES256
7. From the **Hash algorithm** drop-down list, select one of the following hash types:
  - MD5

- SHA
  - SHA1-96
  - SHA2-256-128
  - SHA2-384-192
8. ArubaOS VPNs support client authentication using pre-shared keys, RSA digital certificates, or Elliptic Curve Digital Signature Algorithm (ECDSA) certificates. To set the authentication type for the IKE rule, from the **Authentication** drop-down list, select one of the following options:
    - Pre-Share (for IKEv1 clients using pre-shared keys)
    - RSA (for clients using certificates)
    - ECDSA-256 (for clients using certificates)
    - ECDSA-384 (for clients using certificates)
  9. Diffie-Hellman is a key agreement algorithm that allows two parties to agree upon a shared secret, and is used within IKE to securely establish session keys. To set the Diffie-Hellman Group for the ISAKMP policy, from the **Diffie hellman group** drop-down list, select one of the following options:
    - Group 1: 768-bit Diffie-Hellman prime modulus group
    - Group 2: 1024-bit Diffie-Hellman prime modulus group
    - Group 14: 2048-bit Diffie-Hellman prime modulus group
    - Group 19: 256-bit random Diffie-Hellman ECP modulus group
    - Group 20: 384-bit random Diffie-Hellman ECP modulus group




---

Configuring Diffie-Hellman Group 1 and Group 2 types are not permitted if FIPS mode is enabled.

---

10. Set the **PRF** (Pseudo-Random Function) value. This algorithm is an HMAC function used to hash certain values during the key exchange:
  - PRF-HMAC-MD5
  - PRF-HMAC-SHA1
  - PRF-HMAC-SHA256
  - PRF-HMAC-SHA384
11. In **Lifetime**, enter a value in the range of 300-86400 seconds to define the lifetime of the security association. The default value is 7200 seconds.
12. Click **Submit**.
13. Click **Pending Changes**.
14. In the **Pending Changes** window, select the check box and click **Deploy Changes**.

### Setting the IPsec Dynamic Map

Dynamic maps enable IPsec SA negotiations from dynamically addressed IPsec peers. ArubaOS has predefined IPsec dynamic maps for IKEv2. If you do not want to use these predefined maps, you can use the procedures below to delete a factory-default map, edit an existing map, or create your own custom IPsec dynamic map instead.

1. In the **Mobility Master** node hierarchy, navigate to **Configuration > Services > VPN**.
2. Click **IKEv2** to expand that section.
3. In **IKEv1 IPsec Dynamic Maps**, click an existing dynamic map to edit it or click **+** to create a new map.
4. In **Priority**, enter a priority number for this map. Negotiation requests for security associations try to match the highest-priority map first. If that map does not match, the negotiation request continues down the list to the next-highest priority map until a match is made.



5. In **Name**, enter a name for the dynamic map.
6. (Optional) Configure Perfect Forward Secrecy (PFS) settings for the dynamic peer by assigning a Diffie-Hellman prime modulus group. PFS group provides an additional level of security by ensuring that the IPsec SA key was not derived from any other key, and therefore, cannot be compromised if another key is broken. In the **PFS group** drop-down list, select one of the following groups:
  - Group 1: 768-bit Diffie-Hellman prime modulus group
  - Group 2: 1024-bit Diffie-Hellman prime modulus group
  - Group 14: 2048-bit Diffie-Hellman prime modulus group
  - Group 19: 256-bit random Diffie-Hellman ECP modulus group
  - Group 20: 384-bit random Diffie-Hellman ECP modulus group
7. In **Transforms**, select an existing transform to edit it, or click + to open the **New Transform** section.




---

To view current configuration settings for an IPsec transform-set, access the CLI and issue the command **crypto ipsec transform-set tag <transform-set-name>**.

---

8. From the **Encryption** drop-down list, select one of the following encryption types:
  - DES
  - 3DES
  - AES128
  - AES192
  - AES256
9. From the **Hash** algorithm drop-down list, select one of the following hash types:
  - MD5
  - SHA
  - SHA1-96
  - SHA2-256-128
  - SHA2-384-192
10. In **Lifetime(seconds)**, enter a value in the range of 300-86400 seconds to define the lifetime of the security association for the dynamic peer. The default value is 7200 seconds.
11. In **Lifetime(kilobytes)**, enter a value in kilobytes to define the lifetime of the security association for the dynamic peer.
12. Click **Submit**.
13. Click **Pending Changes**.
14. In the **Pending Changes** window, select the check box and click **Deploy Changes**.

## In the CLI

To configure a remote access VPN for L2TP IPsec using IKEv2:

1. Define the server addresses:
 

```
(host) [mynode] (config) #vpdn group l2tp
enable
client configuration {dns|wins} <ipaddr1> [<ipaddr2>]
```
2. Enable authentication methods for IKEv2 clients:
 

```
(host) [mynode] (config) #crypto isakmp eap-passthrough {eap-mschapv2|eap-peap|eap-tls}
```
3. Create address pools:
 

```
(host) [mynode] (config) #ip local pool <pool> <start-ipaddr> <end-ipaddr>
```
4. Configure source NAT:

```
(host) [mynode] (config) #ip access-list session srcnat user any any src-nat pool <pool>
position 1
```

5. If you are configuring a VPN to support machine authentication using certificates, define server certificates for VPN clients using IKEv2:

```
(host) [mynode] (config) #crypto-local isakmp server-certificate <cert>
```



---

The IKE pre-shared key value must be between 6-64 characters. To configure a pre-shared IKE key that contains non-alphanumeric characters, surround the key with quotation marks.

For example: **crypto-local isakmp key "key with spaces" fqdn-any.**

---

6. Define IKEv2 Policies:

```
(host) [mynode] (config) #crypto isakmp policy <priority>
encryption {3des|aes128|aes192|aes256|des}
version v2
authentication {pre-share|rsa-sig|ecdsa-256|ecdsa-384}
group {1|2|19|20}
hash {md5|sha|sha1-96|sha2-256-128|sha2-384-192}
prf PRF-HMAC-MD5|PRF-HMAC-SHA1|PRF-HMAC-SHA256|PRF-HMAC-SHA384
lifetime <seconds>
```

7. Define IPsec Tunnel parameters:

```
(host) [mynode] (config) #crypto ipsec
mtu <max-mtu>
transform-set <transform-set-name> esp-3des|esp-aes128|esp-aes128-gcm|esp-aes192|esp-
aes256|esp-aes256-gcm|esp-des esp-md5-hmac|esp-null-mac|esp-sha-hmac
```

## Configuring a VPN for Smart Card Clients

This section describes how to configure a remote access VPN on the controller for Microsoft L2TP/IPsec clients with smart cards, which contain a digital certificate allowing user-level authentication without the user entering a username and password. As described earlier in this chapter, L2TP/IPsec requires two levels of authentication: IKE SA (machine) authentication and user-level authentication with an IKEv2 or PPP-based authentication protocol.

Microsoft clients running Windows 7 (and later versions) support both IKEv1 and IKEv2. Microsoft clients using IKEv2 support machine authentication using RSA certificates (but not ECDSA certificates or pre-shared keys) and smart card user-level authentication with EAP-TLS over IKEv2.



---

Windows 7 (and later version) clients without smart cards also support user password authentication using EAP-MSCHAPv2 or PEAP-MSCHAPv2.

---

### Working with Smart Card clients using IKEv2

To configure a VPN for Windows 7 (and later version) clients using smart cards and IKEv2, follow the procedure described in [Configuring a VPN for L2TP/IPsec with IKEv2 on page 349](#), and ensure that the following settings are configured:

- **L2TP** is enabled
- User authentication is set to **EAP-TLS**
- The IKE policy is configured for **ECDSA** or **RSA** certificate authentication

### Working with Smart Card Clients using IKEv1

Microsoft clients using IKEv1, including clients running Windows Vista or earlier versions of Windows, only support machine authentication using a pre-shared key. In this scenario, user-level authentication is performed by an external RADIUS server using PPP EAP-TLS, and client and server certificates are mutually authenticated

during the EAP-TLS exchange. During the authentication, EAP-TLS messages from the client are encapsulated into RADIUS messages and forwarded to the server.

You must configure the L2TP/IPsec VPN with EAP as the PPP authentication and IKE policy for preshared key authentication of the SA.



---

On the RADIUS server, you must configure a remote access policy to allow EAP authentication for smart card users and select a server certificate. The user entry in Microsoft Active Directory must be configured for smart cards.

---

To configure an L2TP/IPsec VPN for clients using smart cards and IKEv1, ensure that the following settings are configured:

1. On a RADIUS server, a remote access policy must be configured to allow EAP authentication for smart card users and to select a server certificate. The user entry in Microsoft Active Directory must be configured for smart cards. (For detailed information on creating and managing user roles and policies, see [Roles and Policies on page 367.](#))
  - Ensure that the RADIUS server is part of the server group used for VPN authentication.
  - Configure other VPN settings as described in [Configuring a VPN for L2TP/IPsec with IKEv2 on page 349](#), while selecting the following options:
    - Select **Enable L2TP**
    - Select **EAP** for the Authentication Protocol.
    - Define an IKE Shared Secret to be used for machine authentication. (To make the IKE key global, specify 0.0.0.0 and 0.0.0.0 for both subnet and subnet mask.)
    - Configure the IKE policy for **Pre-Share** authentication.

## Configuring a VPN for Clients with User Passwords

This section describes how to configure a remote access VPN on the controller for L2TP/IPsec clients with user passwords. As described earlier, L2TP/IPsec requires two levels of authentication: IKE SA authentication and user-level authentication with the PAP authentication protocol. IKE SA is authenticated with a preshared key, which you must configure as an IKE shared secret. User-level authentication is performed by the managed device's internal database.

You must configure the following:

- AAA database entries for username and passwords
- VPN authentication profile, which defines the internal server group and the default role assigned to authenticated clients
- L2TP/IPsec VPN with PAP as the PPP authentication (IKEv1 only).
- (For IKEv1 clients) An IKE policy for preshared key authentication of the SA.
- (For IKEv2 clients) A server certificate to authenticate the managed device to clients, and a CA certificate to authenticate VPN clients.

### In the WebUI

Use the following procedure to configure L2TP/IPsec VPN for username/password clients via the WebUI:

1. In the **Mobility Master** node hierarchy, navigate to the **Configuration > Authentication > Auth Servers** window.
  - a. Select **Internal** from the **Server Groups** table, and then select **Internal** from the **Server Group > Internal** table to display entries for the internal database.
  - b. Under **Server Group > Internal > Internal > Users**, click +.

- c. Enter the **User Name** and **Password** information for the client.
- d. Select **Enabled** to activate this entry on creation.
- e. Click **Submit**.
- f. Click **Pending Changes**.
- g. In the **Pending Changes** window, select the check box and click **Deploy Changes**.
2. In the **Managed Network** node hierarchy, navigate to the **Configuration > Authentication > L3 Authentication** page.
  - a. Under the **default** VPN Authentication Profile, select **Server Group**.
  - b. Select the **internal** server group from the drop-down list.
  - c. Click **Save**.
  - d. Click **Pending Changes**.
  - e. In the **Pending Changes** window, select the check box and click **Deploy Changes**.
3. Navigate to the **Configuration > Services > VPN** page.
  - a. Click **IKEv1** to expand that section.
  - b. Select **Enabled** for **L2tp** (this is enabled by default).
  - c. Select **PAP** for **Auth Protocols**.
  - d. Click **Submit**.
  - e. Click **Pending Changes**.
  - f. In the **Pending Changes** window, select the check box and click **Deploy Changes**.
4. Configure other VPN settings as described in [Configuring a VPN for L2TP/IPsec with IKEv2 on page 349](#), while ensuring that the following settings are selected:
  - In the **Configuration > Services > VPN** page, enable **L2TP**.
  - In the **Configuration > Services > VPN** page, select **PAP** as the authentication protocol.

## In the CLI

The following example uses the command-line interface to configure a L2TP/IPsec VPN for username/password clients using IKEv1:

```
(host) [mynode] (config) #vpdn group l2tp
enable
ppp authentication pap
client dns 101.1.1.245

(host) [mynode] (config) #ip local pool pw-clients 10.1.1.1 10.1.1.250

(host) [mynode] (config) #crypto isakmp key <key> address 0.0.0.0 netmask 0.0.0.0

(host) [mynode] (config) #crypto isakmp policy 1
authentication pre-share
```

Next, issue the following command in *enable* mode to configure client entries in the internal database:

```
(host) [mynode] #local-userdb add username <name> password <password>
```

## Configuring Remote Access VPNs for XAuth

Extended Authentication (XAuth) is an Internet Draft that permits user authentication after IKE Phase 1 authentication. This authentication prompts the user for a username and password, in which user credentials are authenticated with an external RADIUS or LDAP server or the managed device's internal database. Alternatively, the user can start client authentication with a smart card, which contains a digital certificate to

verify the client credentials. IKE Phase 1 authentication can be done with either an IKE preshared key or digital certificates.

## Configuring VPNs for XAuth Clients using Smart Cards

This section describes how to configure a remote access VPN on Mobility Master for Cisco VPN XAuth clients using smart cards. Smart cards contain a digital certificate, allowing user-level authentication without the user entering a username and password. IKE Phase 1 authentication can be done with either an IKE preshared key or digital certificates; for XAuth clients using smart cards, the smart card digital certificates must be used for IKE authentication. The client is authenticated with the internal database.

You must configure the following:

1. Add entries for Cisco VPN XAuth clients to the managed device's internal database, or to an external RADIUS or LDAP server. For details on configuring an authentication server, see [Authentication Servers on page 180](#).



---

For each client, create an entry in the internal database with the entire Principal name (SubjectAltname in X.509 certificates) or Common Name as it appears on the certificate.

---

2. Verify that the server with the client data is part of the server group associated with the VPN authentication profile.
3. In the **IKEv1** section of the **Configuration > Services > VPN** page, set **L2tp** to **Enabled**.
4. In the **IKEv1** section of the **Configuration > Services > VPN** page, set **XAuth** to **Enabled**.
5. The Phase 1 IKE exchange for XAuth clients can be either **Main Mode** or **Aggressive Mode**. Aggressive Mode condenses the IKE SA negotiations into three packets (versus six packets for Main Mode). In the **Aggressive group name** field of the **Configuration > Services > VPN** page, **General Vpn** section, enter the authentication group name for aggressive mode to associate this setting to multiple clients. Make sure that the group name matches the aggressive mode group name configured in the VPN client software.
6. Configure other VPN settings as described in [Configuring a VPN for L2TP/IPsec with IKEv2 on page 349](#), while ensuring that the following settings are selected:
  - In the **IKEv1** section of the **Configuration > Services > VPN** page, set **L2tp** to **Enabled**.
  - In the **IKEv1** section of the **Configuration > Services > VPN** page, set **XAuth** to **Enabled**.
  - Define an IKE policy to use **RSA** or **ECDSA** authentication.

## Configuring a VPN for XAuth Clients Using a Username and Password

This section describes how to configure a remote access VPN on Mobility Master for Cisco VPN XAuth clients using passwords. IKE Phase 1 authentication is done with an IKE preshared key; users are then prompted to enter their username and password, which is verified with the internal database.

You must configure the following:

1. Add entries for Cisco VPN XAuth clients to the managed device's internal database. For details on configuring an authentication server, see [Authentication Servers on page 180](#)



---

For each client, you need to create an entry in the internal database with the entire Principal name (SubjectAltname in X.509 certificates) or Common Name as it appears on the certificate.

---

2. Verify that the server with the client data is part of the server group associated with the VPN authentication profile.
3. Configure other VPN settings as described in [Configuring a VPN for L2TP/IPsec with IKEv2 on page 349](#), while ensuring that the following settings are selected:

- In the **IKEv1** section of the **Configuration > Services > VPN** page, set **L2tp** to **Enabled**.
- In the **IKEv1** section of the **Configuration > Services > VPN** page, set **XAuth** to **Enabled**.
- The IKE policy must have **pre-share** authentication.

## Working with Remote Access VPNs for PPTP

Point-to-Point Tunneling Protocol (PPTP) is an alternative to L2TP/IPsec. Like L2TP/IPsec, PPTP provides a logical transport mechanism using tunneling or encapsulation to send PPP frames across an IP network. PPTP relies on the PPP connection process to perform user authentication and protocol configuration.

With PPTP, data encryption begins after PPP authentication and connection process is completed. PPTP connections are encrypted through Microsoft Point-to-Point Encryption (MPPE), which uses the Rivest-Shamir-Aldeman (RSA) RC-4 encryption algorithm. PPTP connections require user-level authentication through a PPP-based authentication protocol (MSCHAPv2 is the currently-supported method).

### In the CLI

```
(host) [mynode] (config) #vpdn group pptp
    enable
    client configuration {dns|wins} <ipaddr1> [<ipaddr2>]
    ppp authentication {mschapv2}
```

```
(host) [mynode] (config) #pptp ip local pool <pool_name> <pool_start_address> [<pool_end_address>]
```

## Working with Site-to-Site VPNs

Site-to-site VPNs allow sites in different locations to securely communicate with each other over a Layer-3 network such as the Internet. You can use managed device instead of VPN concentrators to connect the sites. You can also use a VPN concentrator at one site and a managed device at the other site.

Mobility Master supports the following IKE SA authentication methods for site-to-site VPNs:

- **Preshared key:** The same IKE shared secret must be configured on both the local and remote sites. The management MAC address of the Mobility Master should be added as the peer MAC address in the managed device to establish the IKE/IPSEC tunnel with the Mobility Master.
- **Suite-B cryptographic algorithms:** Managed Devices support Suite-B cryptographic algorithms when the Advanced Cryptography (ACR) license is installed. For more information, see [Understanding Suite-B Encryption Licensing on page 339](#).
- **Digital certificates:** You can configure an RSA or ECDSA server certificate and a CA certificate for each site-to-site VPN IPsec map configuration. If you use certificate-based authentication, the peer must be identified by its certificate subject name, distinguished name (for deployments using IKEv2), or by the peer's IP address (for IKEv1). For more information about importing server and CA certificates into Mobility Master, see [Management Access on page 760](#).




---

Certificate-based authentication is only supported for site-to-site VPN between two managed devices with static IP addresses. IKEv1 site-to-site tunnels cannot be created between a Mobility Master and managed device.

---

Enable IP compression in an IPsec map to reduce the size of data frames transmitted over a site-to-site VPN between 7200 Series or 7000 Series controllers using IKEv2 authentication. IP compression can reduce the time required to transmit the frame across the network. When this hardware-based compression feature is enabled, the quality of unencrypted traffic (such as Lync or Voice traffic) is not compromised by increased latency or decreased throughput. IP compression is disabled by default.



This feature is only supported in an IPv4 network using IKEv2. This feature cannot be enabled on a 7205 controller or on a site-to-site VPN established using IKEv1.

## Working with Third-Party Devices

Managed Devices can use IKEv1 or IKEv2 to establish a site-to-site VPN with another managed device or third-party remote client devices. Devices running Microsoft® Windows 2008 can use Suite-B cryptographic algorithms and IKEv1 to support authentication using RSA or ECDSA. StrongSwan® 4.3 devices can use IKEv2 to support authentication using RSA or ECDSA certificates, Suite-B cryptographic algorithms, and pre-shared keys. These two remote clients are tested to work with managed devices using Suite-B cryptographic algorithm.

## Working with Site-to-Site VPNs with Dynamic IP Addresses

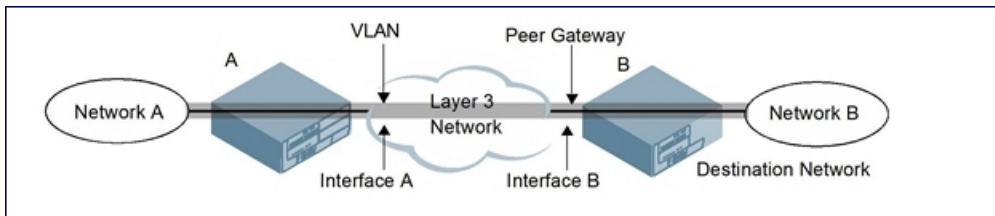
ArubaOS supports site-to-site VPNs with two statically addressed managed devices, or with one static and one dynamically addressed managed device. Two methods are supported to enable dynamically addressed peers:

- **Pre-shared Key Authentication with IKE Aggressive Mode:** The managed device with a dynamic IP address must be configured as the initiator of IKE Aggressive-mode for Site-Site VPNs, while the managed device with a static IP address must be configured as the responder of IKE Aggressive mode. Note that when the managed device is operating in FIPS mode, IKE aggressive mode must be disabled.
- **X.509 certificates:** IPsec peers will identify each other using the subject name of X.509 certificates. IKE operates in main mode when this option is selected. This method is preferred from a security standpoint.

## Understanding VPN Topologies

You must configure VPN settings on the managed devices at both the local and remote sites. In the following figure, a VPN tunnel connects Network A to Network B across the Internet.

**Figure 32** Site-to-Site VPN Configuration Components



To configure the VPN tunnel on managed device A, you must configure the following:

- The source network (Network A)
- The destination network (Network B)
- The VLAN on which managed device A's interface to the Layer-3 network is located (Interface A in [Figure 32](#))
- The peer gateway, which is the IP address of managed device B's interface to the Layer-3 network (Interface B in [Figure 32](#))



Configure VPN settings on the managed device at both the local and remote sites.

## Configuring Site-to-Site VPNs

Use the following procedures to create a site-to-site VPN via the WebUI or CLI.

## In the WebUI

1. In the **Mobility Master** node hierarchy, navigate to the **Configuration > Services > VPN** page, and click **Site to Site** to open that section.
2. In the **IPsec Maps** section, click **+** to open the **Create New Ipsec** section.
3. Enter a name for this VPN connection in the **Name** field.
4. Select **Enabled** so this configuration takes effect as soon as it is saved.
5. In the **Priority** field, enter a priority level for the IPsec map. Negotiation requests for security associations try to match the highest-priority map first. If that map does not match, the negotiation request continues down the list to the next-highest priority map until a match is made.
6. Select a **Source network type** to specify whether the VPN *source*, the local network connected to the managed device, is defined by an IP address or a VLAN ID.
  - If you selected **IP Address**, enter the IP address and netmask for the source network (see managed device A in [Figure 32](#)).
  - If you selected **VLAN**, click the **VLAN** drop-down list and select the VLAN ID for the source network.
7. In the **Destination network** and **Destination subnet mask** fields, enter the IP address and netmask for the *destination*, the remote network to which the local network communicates (see managed device B in [Figure 32](#)).
8. The **SA Lifetime** parameter defines the lifetime of the security association in seconds and kilobytes. For seconds, the default value is **7200**. To change this value, enter a value between 300 and 86400 seconds. Range: 1000–1000000000 kilobytes.
9. Click the **Version** drop-down list and select **v1** to configure the VPN for IKEv1, or **v2** for IKEv2.
10. (Optional) Click the **Policies** drop-down list and select a predefined or custom IKE policy to apply to the IPsec map. For more information on default IKE policies, see [Table 64](#).
11. IKEv2 site-to-site VPNs between Mobility Master and 7000 Series controllers support traffic compression between those devices. Set **IP compression** to **Enabled** to enable compression for traffic in the site-to-site tunnel.
12. Set **Factory certificate authentication** to **Enabled** to enable the authentication.
13. Select the **VLAN** containing the interface of the managed device that connects to the Layer-3 network (see Interface A in [Figure 32](#)).

This determines the source IP address used to initiate IKE. If you select **0** or **None**, the default is the VLAN of the managed device's IP address (either the VLAN where the loopback IP is configured, or VLAN 1 if no loopback IP is configured).
14. If you enable **PFS** mode, new session keys are not derived from previously used session keys. Therefore, if a key is compromised, that compromised key does not affect any previous session keys. PFS mode is disabled by default. To enable this feature, click the **PFS** drop-down list and select one of the following **Perfect Forward Secrecy** modes:
  - **group1** : 768-bit Diffie–Hellman prime modulus group
  - **group2** : 1024-bit Diffie–Hellman prime modulus group
  - **group 14** : 2048-bit Diffie–Hellman prime modulus group
  - **group19** : 256-bit random Diffie–Hellman ECP modulus group
  - **group20** : 384-bit random Diffie–Hellman ECP modulus group
15. Set **Pre-connect** to **Enabled** to establish the VPN connection, even if there is no traffic being sent from the local network. If you do not select this, the VPN connection is established only when traffic is sent from the local network to the remote network.
16. Set **Trusted tunnel** to **Enabled** if traffic between the networks is trusted. If you do not select this, traffic between the networks is untrusted.



17. Set **Enforce NATT** to **Enabled** to enforce UDP 4500 for IKE and IPsec. This option is disabled by default.
18. Add one or more transform sets to be used by the IPsec map. Click +, and select an existing transform set or create a new one. Then click **Apply** to add that transform set to the IPsec map.
19. For site-to-site VPNs with dynamically addressed peers, select **Dynamic** from the **Remote peer addressing** drop-down list.
  - a. From the **Peer gateway** drop-down list, select **Initiator** if the dynamically addressed switch is the *initiator* of IKE Aggressive-mode for Site-Site VPNs, or select **Responder** if the dynamically addressed switch is the *responder* for IKE Aggressive-mode.
  - b. In the **FQDN** field, enter a fully qualified domain name (FQDN) for the managed device. If the managed device is defined as a dynamically addressed responder, you can select **All Peers** to make the managed device a responder for all VPN peers, or select **Per Peer Id** and specify the FQDN to make the managed device a responder for one specific initiator.
20. For **Remote peer addressing** that is **Static**, select one of the supported peer gateway types:
  - **IP Address**: Select this option to identify the remote end point of the VPN tunnel using an IP address.
  - **FQDN** : This option allows you to use same FQDN across different branches. The FQDN resolves to different IP addresses for each branch, based on its local DNS setting.
21. Define the Peer Gateway using an IP address or FQDN.
  - If you use IKEv1 to establish a site-to-site VPN for a statically addressed remote peer and selected **IP Address** in the previous step, enter the IP address of the interface used by the remote peer to connect to the L3 network in the **Peer Gateway** field (see Interface B in [Figure 32](#)).
  - If you are configuring an IPsec map for a dynamically addressed remote peer, and selected **IP Address** in the previous step, leave the peer gateway set to its default value of **0.0.0.0**.
  - If you selected **FQDN** as the peer gateway type in the previous step, enter the fully qualified domain name for the remote peer.
22. Select one of the following authentication types:
  - a. For pre-shared key authentication, select **PSK**, select the **Representation type**, then enter a shared secret in the **IKE shared secret** and **Retype shared secret** fields. This authentication type is generally required in IPsec maps for a VPN with dynamically addressed peers, but can also be used for a static site-to-site VPN.
  - b. For certificate authentication, select **Certificate**, then click the **Server certificate** and **CA certificate** drop-down lists to select certificates previously imported into the controller. See [Management Access on page 760](#) for more information. Enter the **Peer certificate subject name**.




---

To identify the subject name of a peer certificate, issue the following command in the CLI:  
`show crypto-local pki servercert <certname> subject`

---

23. Click **Submit**.
24. Click **Pending Changes**.
25. In the **Pending Changes** window, select the check box and click **Deploy Changes**.
26. Click the **IKEv1** or **IKEv2** section (match the IKE version that you selected in Step 9) to configure an IKE policy.
  - a. Under **IKE Policies**, click + to open the **Add IKE Policy** configuration page.
  - b. Set the **Priority** to **1** for this configuration to take priority over the Default setting.
  - c. Set **Enable policy** to **Enabled** so the configuration takes effect as soon as it is saved.
  - d. Set the **Encryption** from the drop-down list.
  - e. Set the **HASH algorithm** from the drop-down list.

- f. Set the **Authentication** to **pre-share** if you use pre-shared keys. If you use certificate-based IKE, select **rsa** or **ecdsa**.
- g. Set the **Diffie hellman group** from the drop-down list.
- h. Set the **Lifetime** to define the lifetime of the security association in seconds. The default value is 7200 seconds. To change this value, enter a value between **300** and **86400** seconds.
- i. The IKE policy selections, including any pre-shared key, must be reflected in the VPN client configuration. When using a third-party VPN client, set the VPN configuration on clients to match the choices made above. If you use the Aruba dialer, you must configure the dialer prior to downloading the dialer onto the local client.
- j. Click **Submit**.
- k. Click **Pending Changes**.
- l. In the **Pending Changes** window, select the check box and click **Deploy Changes**.

## In the CLI

To configure a site-to-site VPN with two static IP managed devices using IKEv1, issue the following commands in the CLI:

```
(host) [mynode] (config) #crypto-local ipsec-map <ipsec-map-name> <ipsec-map-number>
  src-net <ipaddr> <mask>
  dst-net <ipsec-map-dst-net> <ipsec-map-dst-mask>
  peer-ip <ipaddr>
  vlan <ipsec-map-vlan-id>
  version {v1|v2}
  peer-cert-dn <peer-dn>
  pre-connect {enable|disable}
  trusted enable
```

For certificate authentication:

```
set ca-certificate <cacert-name>
set server-certificate <cert-name>
```

```
(host) [mynode] (config) #crypto isakmp policy <priority>
  encryption {3DES|AES128|AES192|AES256|DES}
  version {v1|v2}
  authentication {pre-share|rsa-sig|ecdsa-256|ecdsa-384}
  group {1|2|14|19|20}
  hash {md5|sha|sha1-96|sha2-256-128|sha2-384-192}
  lifetime <seconds>
```

For pre-shared key authentication:

```
(host) [mynode] (config) #crypto-local isakmp {key <keystring>|key-hex <keystring>}
  address <peer-address> netmask <mask>
```

```
(host) [mynode] (config) #crypto isakmp policy <priority>
  encryption {3DES|AES128|AES192|AES256|DES}
  version {v1|v2}
  authentication {pre-share|rsa-sig|ecdsa-256|ecdsa-384}
  group {1|2|14|19|20}
  hash {md5|sha|sha1-96|sha2-256-128|sha2-384-192}
  lifetime <seconds>
```

To configure site-to-site VPN with a static and dynamically addressed managed device that initiates IKE Aggressive-mode for Site-Site VPN:

```
(host) [mynode] (config) #crypto-local ipsec-map <ipsec-map-name> <ipsec-map-number>
  src-net <ipaddr> <mask>
  dst-net <ipsec-map-dst-net> <ipsec-map-dst-mask>
  peer-ip <ipaddr>
```

```
local-fqdn <local_id_fqdn>
vlan <ipsec-map-vlan-id>
pre-connect {enable|disable}
trusted enable
```

For the Pre-shared-key:

```
(host) [mynode] (config) #crypto-local isakmp {key <keystring>|key-hex <keystring>}
address <peer-address> netmask 255.255.255.255
```

For a static IP managed device that responds to IKE Aggressive-mode for Site-Site VPN:

```
(host) [mynode] (config) #crypto-local ipsec-map <ipsec-map-name 2> <ipsec-map-number>
src-net <ipaddr> <mask>
dst-net <ipsec-map-dst-net> <ipsec-map-dst-mask>
peer-ip 0.0.0.0
peer-fqdn fqdn-id <peer_id_fqdn>
vlan <ipsec-map-vlan-id>
trusted enable
```

For the Pre-shared-key:

```
(host) [mynode] (config) #crypto-local isakmp {key <keystring>|key-hex <keystring>}
fqdn <ike-id-fqdn>
```

For a static IP managed device that responds to IKE Aggressive-mode for Site-Site VPN with one PSK for All FQDNs:

```
(host) [mynode] (config) #crypto-local ipsec-map <ipsec-map-name 2> <ipsec-map-number>
src-net <ipaddr> <mask>
peer-ip 0.0.0.0
peer-fqdn any-fqdn
vlan <ipsec-map-vlan-id>
trusted enable
```

For the Pre-shared-key for All FQDNs:

```
(host) [mynode] (config) #crypto-local isakmp {key <keystring>|key-hex <keystring>}
fqdn-any
```

## Detecting Dead Peers

Dead Peer Detection (DPD) is enabled by default on the controller for site-to-site VPNs. DPD, as described in RFC 3706, "A Traffic-Based Method of Detecting Dead Internet Key Exchange (IKE) Peers," uses IPsec traffic patterns to minimize the number of IKE messages required to determine the liveness of an IKE peer.

After a dead peer is detected, the managed device tears down the IPsec session. Once the network path or other failure condition has been corrected, a new IPsec session is automatically re-established.

To configure DPD parameters, issue the following commands through the CLI:

```
(host) [mynode] (config) #crypto-local isakmp dpd idle-timeout <idle_sec> retry-timeout
<retry_sec> retry-attempts <retry_number>
```

## About Default IKE Policies

ArubaOS includes the following default IKE policies. These policies are predefined, but can be edited and deleted. You can do this in the CLI by using the **crypto isakmp policy** and **crypto dynamic-map** commands, or the WebUI by navigating to **Configuration > Services > VPN**. To delete an IKE policy, select an existing policy and click the trash icon to delete the policy.

**Table 64:** Default IKE Policy Settings

Policy Name	Policy Number	IKE Version	Encryption Algorithm	Hash Algorithm	Authentication Method	PRF Method	Diffie-Hellman Group
Default protection suite	10001	IKEv1	3DES-168	SHA 160	Pre-Shared Key	N/A	2 (1024 bit)
Default RAP Certificate protection suite	10002	IKEv1	AES -256	SHA 160	RSA Signature	N/A	2 (1024 bit)
Default RAP PSK protection suite	10003	IKEv1	AES -256	SHA 160	Pre-Shared Key	N/A	2 (1024 bit)
Default RAP IKEv2 RSA protection suite	10004	IKEv2	AES -256	SSHA160	RSA Signature	hmac-sha1	2 (1024 bit)
Default Cluster PSK protection suite	10005	IKEv1	AES -256	SHA160	Pre-Shared Key	Pre-Shared Key	2 (1024 bit)
Default IKEv2 RSA protection suite	10006	IKEv2	AES - 128	SHA 96	RSA Signature	hmac-sha1	2 (1024 bit)
Default IKEv2 PSK protection suite	10007	IKEv2	AES - 128	SHA 96	Pre-shared key	hmac-sha1	2 (1024 bit)
Default Suite-B 128bit ECDSA protection suite	10008	IKEv2	AES - 128	SHA 256-128	ECDSA-256 Signature	hmac-sha2-256	Random ECP Group (256 bit)

Policy Name	Policy Number	IKE Version	Encryption Algorithm	Hash Algorithm	Authentication Method	PRF Method	Diffie-Hellman Group
Default Suite-B 256 bit ECDSA protection suite	10009	IKEv2	AES -256	SHA 384-192	ECDSA-384 Signature	hmac-sha2-384	Random ECP Group (384 bit)
Default Suite-B 128bit IKEv1 ECDSA protection suite	10010	IKEv1	AES-GCM-128	SHA 256-128	ECDSA-256 Signature	hmac-sha2-256	Random ECP Group (256 bit)
Default Suite-B 256-bit IKEv1 ECDSA protection suite	10011	IKEv1	AES-GCM-256	SHA 256-128	ECDSA-256 Signature	hmac-sha2-256	Random ECP Group (256 bit)

## Working with VPN Dialer

For Windows clients, a dialer can be downloaded from Mobility Master to auto-configure tunnel settings on the client.

### Configuring VPN Dialer

#### In the CLI

Issue the following commands in the CLI to configure the VPN dialer:

```
(host) [mynode] (config) #vpn-dialer <name>
  enable {dnctclear|l2tp|pptp|secureid_newpinmode|wirednowifi}
  ike authentication {pre-share <key>|rsa-sig}
  ike encryption {3des|des}
  ike group {1|2}
  ike hash {md5|sha}
  ipsec encryption {esp-3des|esp-des}
  ipsec hash {esp-md5-hmac|esp-sha-hmac}
  ppp authentication {cache-securid|chap|mschap|mschapv2|pap}
```

### Assigning a Dialer to a User Role

The VPN dialer can be downloaded using Captive Portal. For the user role assigned through Captive Portal, configure the dialer by using the dialer name.

For example, if the Captive Portal client is assigned to the *guest* role after logging in, and the dialer is called *mydialer*, configure *mydialer* as the dialer to be used in the guest role.

## In the CLI

To configure the Captive Portal dialer for a user-role via the CLI, access the CLI in config mode and issue the following commands:

```
(host) [mynode] (config) #user-role <role>  
    dialer <name>
```

The client in an Aruba user-centric network is associated with a *user role*, which determines the client's network privileges, how often it must re-authenticate, and which bandwidth contracts are applicable. A *policy* is a set of rules that applies to traffic that passes through the Aruba managed device. You specify one or more policies for a user role. Finally, you can assign a user role to clients before or after they authenticate to the system.

This chapter describes assigning and creating roles and policies using the ArubaOS CLI or WebUI.

Topics in this chapter include:

- [Configuring Firewall Policies on page 367](#)
- [User Roles on page 376](#)
- [Assigning User Roles on page 378](#)
- [Understanding Global Firewall Parameters on page 383](#)
- [AppRF 2.0 on page 389](#)



---

This chapter describes configuring firewall policies and parameters that relate to IPv4 traffic. See [IPv6 Support on page 122](#) for information about configuring IPv6 firewall policies and parameters.

---

## Configuring Firewall Policies

A firewall policy identifies specific characteristics about a data packet passing through the Aruba Mobility Master and takes some action based on that identification. In an Aruba Mobility Master, that action can be a firewall-type action such as permitting or denying the packet, an administrative action such as logging the packet, or a quality of service (QoS) action such as setting 802.1p bits or placing the packet into a priority queue. You can apply firewall policies to user roles to give differential treatment to different users on the same network, or to physical ports to apply the same policy to all traffic through the port.

Firewall policies differ from access control lists (ACLs) in the following ways:

- Firewall policies are *stateful*, meaning that they recognize flows in a network and keep track of the state of sessions. For example, if a firewall policy permits telnet traffic from a client, the policy also recognizes that inbound traffic associated with that session should be allowed.
- Firewall policies are *bi-directional*, meaning that they keep track of data connections traveling into or out of the network. ACLs are normally applied to either traffic inbound to an interface or outbound from an interface.
- Firewall policies are *dynamic*, meaning that address information in the policy rules can change as the policies are applied to users. For example, the alias *user* in a policy automatically applies to the IP address assigned to a particular user. ACLs typically require static IP addresses in the rule.



---

You can apply IPv4 and IPv6 firewall policies to the same user role. See [IPv6 Support on page 122](#) for information about configuring IPv6 firewall policies.

---

## Working With ACLs

ACLs are a common way of restricting certain types of traffic on a physical port. ArubaOS provides the following types of ACLs:

- Standard ACLs permit or deny traffic based on the source IP address of the packet. Standard ACLs can be either named or numbered, with valid numbers in the range of 1-99 and 1300-1399. Standard ACLs use a bitwise mask to specify the portion of the source IP address to be matched.
- Extended ACLs permit or deny traffic based on source or destination IP address, source or destination port number, or IP protocol. Extended ACLs can be named or numbered, with valid numbers in the range 100-199 and 2000-2699.
- MAC ACLs are used to filter traffic on a specific source MAC address or range of MAC addresses. Optionally, you can mirror packets to a datapath or remote destination for troubleshooting and debugging purposes. MAC ACLs can be either named or numbered, with valid numbers in the range of 700-799 and 1200-1299.
- Ethertype ACLs are used to filter based on the Ethertype field in the frame header. Optionally, you can mirror packets to a datapath or remote destination for troubleshooting and debugging purposes. Ethertype ACLs can be either named or numbered, with valid numbers in the range of 200-299. These ACLs can be used to permit IP while blocking other non-IP protocols, such as IPX or AppleTalk.
- Service ACLs provide a generic way to restrict how protocols and services from specific hosts and subnets to the Mobility Master are used. Rules with this ACL are applied to all traffic on the Mobility Master regardless of the ingress port or VLAN.
- Routing ACLs forward packets to a device defined by an IPsec map, a next-hop list, a tunnel or a tunnel group.

ArubaOS provides both standard and extended ACLs for compatibility with router software from popular vendors, however firewall policies provide equivalent and greater function than standard and extended ACLs and should be used instead.

You can apply MAC and Ethertype ACLs to a user role, however these ACLs only apply to non-IP traffic *from* the user.

## Creating a Firewall Policy

This section describes how to configure the rules that constitute a firewall policy. A firewall policy can then be applied to a user role (until the policy is applied to a user role, it does not have any effect). [Table 65](#) describes required and optional parameters for a rule.



**Table 65: Firewall Policy Rule Parameters**

Field	Description
IP version	Specifies whether the policy applies to IPv4 or IPv6 traffic.
Source (required)	<p>Source of the traffic, which can be one of the following:</p> <ul style="list-style-type: none"> <li>any: Acts as a wildcard and applies to any source address.</li> <li>user: Refers to traffic from the wireless client.</li> <li>host: Refers to traffic from a specific host. When this option is chosen, you must configure the IP address of the host.</li> <li>network: Refers to a traffic that has a source IP from a subnet of IP addresses. When this option is chosen, you must configure the IP address and network mask of the subnet.</li> <li>alias: Refers to using an alias for a host or network. You configure the alias by navigating to the <b>Configuration &gt; Roles &amp; Policies &gt; Policies</b> tab. Select a policy created and click + to create a Rule. Select the <b>Access Control</b> option in the <b>Rule Type</b>. Select <b>Alias</b> from the <b>Destination</b> drop-down list and the alias name from the <b>Destination alias</b> drop-down list. Select a Source from the traffic <b>Source</b> drop-down list.</li> </ul>
Destination (required)	Destination of the traffic, which can be configured in the same manner as Source.
Service/app (required)	<p>Type of traffic, which can be one of the following:</p> <ul style="list-style-type: none"> <li>any: This option specifies that this rule applies to any type of traffic.</li> <li>application: For session and route policies on a 7000 Series managed device, you can create a rule that applies to a specific application type. Click the <b>Application</b> drop-down list and select an application type.</li> <li>web category/ reputation: For session policies on a 7000 Series managed device, you can create a rule that applies to a specific web category or application type. For more information on web category classification, see <a href="#">Traffic Analysis on page 728</a></li> <li>tcp: Using this option, you configure a range of TCP port(s) to match for the rule to be applied.</li> <li>udp: Using this option, you configure a range of UDP port(s) to match for the rule to be applied.</li> <li>service: Using this option, you use one of the pre-defined services (common protocols such as HTTPS, HTTP, and others) as the protocol to match for the rule to be applied. You can also specify a network service that you configure by navigating to the <b>Configuration &gt; Roles &amp; Policies &gt; Policies</b> tab. Select a policy created and click + to create a Rule. Select the <b>Access Control</b> option in the <b>Rule Type</b>. Select the service type from the <b>Service/app</b> drop-down list.</li> <li>(other than TCP/UDP) by configuring the IP protocol value.</li> </ul>
Action (required)	<p>The action that you want the managed device to perform on a packet that matches the specified criteria. This can be one of the following:</p> <ul style="list-style-type: none"> <li>permit: Permits traffic matching this rule.</li> <li>drop: Drops packets matching this rule without any notification.</li> <li>reject: Drops the packet and sends an ICMP notification to the traffic source.</li> </ul>

Field	Description
	<ul style="list-style-type: none"> <li>● src-nat: Performs network address translation (NAT) on packets matching the rule. When this option is selected, you need to select a NAT pool. Source IP changes to the outgoing interface IP address (implied NAT pool) or from the pool configured (manual NAT pool). This action functions in tunnel/decrypt-tunnel forwarding mode.</li> <li>● dst-nat: This option redirects traffic to the configured IP address and destination port. An example of this option is to redirect all HTTP packets to the captive portal port on the Aruba managed device as used in the pre-defined policy called "captiveportal". This action functions in tunnel/decrypt-tunnel forwarding mode. User should configure the NAT pool in the managed device.</li> <li>● dual-nat: This option performs both source and destination NAT on packets matching the rule. Forward packets from source network to destination; re-mark them with destination IP of the target network. This action functions in tunnel/decrypt-tunnel forwarding mode. User should configure the NAT pool in the managed device.</li> <li>● redirect to tunnel: This option redirects traffic into a GRE tunnel. This option is used primarily to redirect all guest traffic into a GRE tunnel to a DMZ router/switch.</li> <li>● redirect to esi: This option redirects traffic to the specified ESI group. You also specify the direction of traffic to be redirected: forward, reverse, or both directions. Select a NAT Pool from the <b>NAT Pool</b> drop-down list to add a NAT-POOL for ESI policy.</li> <li>● route: Specify the next hop to which packets are routed, which can be one of the following: <ul style="list-style-type: none"> <li>■ Forward Regularly: Packets are forwarded to their next destination without any changes.</li> <li>■ Forward to ipsec-map: Packets are forwarded through an IPsec tunnel defined by the specified IPsec map.</li> <li>■ Forward to next-hop-list: packets are forwarded to the highest priority active device on the selected next hop list. For more information on next-hop lists, see <a href="#">Uplink Routing using Nexthop Lists on page 227</a>.</li> <li>■ Forward to tunnel: Packets are forwarded through the tunnel with the specified tunnel ID. For more information on GRE tunnels, see <a href="#">Configuring GRE Tunnels on page 104</a>.</li> <li>■ Forward to tunnel group: Packets are forwarded through the active tunnel in a GRE tunnel group. For more information on tunnel groups, see <a href="#">GRE Tunnel Groups on page 110</a>.</li> </ul> </li> </ul>
TOS (optional)	Value of type of service (TOS) bits to be marked in the IP header of a packet matching this rule when it leaves the managed device.
Time Range	You can create an <b>absolute</b> time range with a single fixed start and end date and time, or create a <b>periodic</b> (recurring) time range that starts and ends at a specified time on a weekday, weekend, or selected day.
Log (optional)	Logs a match to this rule. This is recommended when a rule indicates a security breach, such as a data packet on a policy that is meant only to be used for voice calls.

Field	Description
Mirror (optional)	Mirrors session packets to datapath or remote destination.
Queue (optional)	The queue in which a packet matching this rule should be placed. Select <b>High</b> for higher priority data, such as voice, and <b>Low</b> for lower priority traffic.
Time Range (optional)	Time range for which this rule is applicable. To configure time range, navigate to <b>Configuration &gt; Roles &amp; Policies &gt; Roles</b> tab. Select a role and click + in the <b>Global Rules</b> table. Select a time range from the <b>Time range</b> drop-down list.
Pause ARM Scanning (optional)	Pause ARM scanning while traffic is present. Note that you must enable "VoIP Aware Scanning" in the ARM profile for this feature to work.
Black List (optional)	Automatically blacklists a client that is the source or destination of traffic matching this rule. This option is recommended for rules that indicate a security breach where the blacklisting option can be used to prevent access to clients that are attempting to breach the security.
ACL White List (optional)	A rule must explicitly permit a traffic session before it is forwarded to the managed device. The last rule in the white list denies everything else. Configure white list ACLs on the <b>Configuration &gt; Services &gt; Firewall &gt; ACL White List</b> accordion.
802.1p Priority (optional)	When this parameter is enabled, the value of 802.1p priority bits are marked in the frame of a packet matching this rule when it leaves the managed device. 0 is the lowest priority (background traffic) and 7 is the highest (network control).

Follow the steps below to create a 'web-only' policy that allows web (HTTP and HTTPS) access.

### In the WebUI

1. In the **Managed Device** node hierarchy, navigate to the **Configuration > Roles & Policies > Policies** tab.
2. Click + to create a new policy.
3. Enter the policy name in the **Policy name** field.
4. Select a the policy type from the **Policy type** drop-down list. You can select **Ethertype, Extended, MAC, Route, Session, or Standard**.
5. Click **Submit**.
6. Select the policy created and click + in the **Policy <policy name>** table.
7. Select **Access Control** option in the **Rule Type** field.
8. Click **OK**.
9. To add a rule that allows HTTP traffic.
  - a. Under **Service/app**, select **Service** from the drop-down list.
  - b. Select **svc-http** from the **Service alias** drop-down list.
10. Click **Submit**.
11. To add a rule that allows HTTPs traffic.
  - a. Under **Service/app**, select **Service** from the drop-down list.

b. Select **svc-https** from the **Servicealias** drop-down list.

12. Click **Submit**.



---

Rules can be re-ordered by using the up and down buttons provided for each rule.

---

13. Click **Submit** to apply this configuration. The policy is not created until the configuration is applied.

14. Click **Pending Changes**.

15. In the **Pending Changes** window, select the check box and click **Deploy changes**.

### In the CLI

```
(host) [md] (config) #ip access-list session web-only
```

## Creating a Network Service Alias

A network service alias defines a TCP, UDP, or IP protocol and a list or range of ports supported by that service. When you create a network service alias, you can use that alias when specifying the network service for multiple session ACLs.

### In the WebUI

1. In the **Managed Device** node hierarchy, navigate to the **Configuration > Roles & Policies > Policies** tab.
2. Click **+** to create a new policy.
3. Enter the policy name in the **Policy name** field.
4. Select a the policy type from the **Policy type** drop-down list. You can select **Ethertype, Extended, MAC, Route, Session, or Standard**.
5. Click **Submit**.
6. Select the policy created and click **+** in the **Policy <policy name>** table.
7. Select **Access Control** option in the **Rule Type** field.
8. Click **OK**.
9. Select **Service** from the **Service/app** drop-down list.
10. Click **+** in the **Service alias** drop-down list to add a new service.
  - a. Enter a value in the **Service name** field.
  - b. In the **Protocol** drop-down, select either **TCP** or **UDP**, or select **protocol** and enter the IP protocol number and **Application level gateway (alg)** of the protocol for which you want to create an alias.
  - c. In the **Port type** drop-down, specify whether you want to define the port by a contiguous range of ports, or by a list of non-contiguous port numbers.
    - If you select **range**, enter the starting and ending port numbers in the **Starting Port** and **End Port** fields.
    - If you select **list**, enter a comma-separated list of port numbers in the **Port list** field.
  - d. To limit the service alias to a specific application, select one the of the following service types from the **Application Level Gateway (alg)** drop-down list:
    - ftp: Service is FTP
    - tftp: Service is TFTP
    - dns: Service is DNS
    - dhcp: Service is DHCP
    - sip: Service is SIP

- sips: Service is Secure SIP
- svp: Service is SVP
- sccp: Service is SCCP
- rtsp: Service is RTSP
- vocera: Service is VOCERA
- noe: Service is Alcatel NOE
- h323: Service is H323
- jabber: Service is Jabber
- facetime: Service is Facetime

11. Click **Submit** to add a new service.

12. Click **Submit**.

13. Click **Pending Changes**.

14. In the **Pending Changes** window, select the check box and click **Deploy changes**.

## In the CLI

To define a service alias via the command-line interface, issue the following command:

```
(host) [md] (config) #net-service <name> <protocol>|tcp|udp {list <port>,<port>}|{<port>
[<port>]} [ALG <service>]
```

## Creating an ACL White List

The ACL white list consists of rules that explicitly permit or deny session traffic from being forwarded to or blocked from the managed device. The white list protects the managed device during traffic session processing by prohibiting traffic from being automatically forwarded to the managed device if it was not specifically denied in a blacklist. The maximum number of entries allowed in the ACL white list is 256. To create an ACL white list, you must first define a white list bandwidth contract, and then assign it to an ACL.

## Creating a Bandwidth Contract

### In the WebUI

1. In the **Mobility Master** node hierarchy, navigate to the **Configuration > Services > Firewall** tab.
2. Click **White List BW Contracts** accordion.
3. Click **+** to create a new contract.
4. In the **White list contract name** field, enter the name of a bandwidth contract.
5. In the **Bandwidth rate** field, enter a bandwidth rate value.
6. Click **Submit**.
7. Click **Pending Changes**.
8. In the **Pending Changes** window, select the check box and click **Deploy changes**.

### In the CLI

```
(host) [mynode] (config) #cp-bandwidth-contract
```

## Configuring the ACL White List

### In the WebUI

1. In the **Mobility Master** node hierarchy, navigate to the **Configuration > Services > Firewall** tab.
2. Click **ACL White List** accordion.
3. Click **+** to create a new protocol.

4. Select **permit** or **deny** from the **Action** drop-down list.

Permit allows session traffic to be forwarded to the managed device and deny blocks session traffic.

5. Select **IPv4** or **IPv6** filter from the **IPversion** drop-down list.

6. Select one of the following from the **Source** drop-down list:

- For a specific IPv4 or IPv6 filter, select **addr\_mask**. Enter the IP address and mask of the IPv4 or IPv6 filter in the corresponding fields.
- For a IPv4 or IPv6 host, select **any** and enter the source address.

7. In the **IP protocol number (1-255)** or **IP protocol** field, enter the number for a protocol or select the protocol from the drop-down list used by session traffic.

8. In the **Starting ports** field, enter a starting port. This is the first port, in the port range, on which permitted or denied session traffic is running. Port range: 1–65535.

9. In the **End port** field, enter an ending port. This is the last port, in the port range, on which permitted or denied session traffic is running. Port range: 1–65535.

10.(Optional) Select the name of the bandwidth contract to which the session traffic should be applied, from the **White list bandwidth contract** drop-down list.

11.For further information on creating bandwidth contracts, see [Configuring Bandwidth Contracts on page 393](#)

12.Click **Submit**. The ACL displays on the white list section.

13.To delete an entry, click **Delete** next to the entry you want to delete.

14.Click **Submit**.

15.Click **Pending Changes**.

16.In the **Pending Changes** window, select the check box and click **Deploy changes**.

### In the CLI

Use the following CLI command to create ACL white lists.

```
(host) [mynode] (config) firewall cp
```

## Override Local Network Destination

This feature provides a scalable solution to create a local net destination override. To implement this feature, a new sub-command, **host vlan – offset** under the **netdestination** configuration command is introduced. An example and description are as follows:

```
netdestination store
  host vlan 10 offset 5
  host vlan 10 offset 8
```

With the above, select the subnet (for example, 10.1.1.0/24) assigned to vlan 10 for that store and calculate offsets 5 (10.1.1.5) and 8 (10.1.1.8) from it.

### Configure the Override Local Netdestination in the WebUI

1. In the **Managed Device** node hierarchy, navigate to the **Configuration > Roles & Policies > Roles** tab.
2. Select a role and click + under **RULES FOR THIS ROLE ONLY** to create a rule.
3. Click one of the options in the **Rule Type** filed to select a rule and click **OK**.
4. Select **Alias** from the **Destination** drop-down list.
5. Select + from the **Destination alias** drop-down list.
6. Click + in the **Rule** table.
7. Select **Override** from the **Rule type** drop-down list.

8. Select a VLAN offset number which is the Netmask/range, from the **Vlan** drop-down list.
9. Click **OK**.
10. Click **Submit** in the **Add New Destination** window.
11. Click **Submit**.
12. Click **Pending Changes**.
13. In the **Pending Changes** window, select the check box and click **Deploy changes**.

## Configure the Override Local Netdestination in the CLI

- Configure the local override netdestination
- Show the local override netdestination
- Local override netdestination used at AOS

To configure the local override netdestination:

```
(host) [md] (config) #netdestination store
(host) [md] (config-submode) #?
  description          Brief description about this destination (up to 128 characters in
  quote)
  host                 Configure a single IPv4 host
  invert              Use all destinations EXCEPT this destination
  name                 Configure a single host name or domain, Max 63 characters
  network              Configure a IPv4 subnet
  no                  Delete Command
  range                Configure a range of IPv4 addresses
(host) [md] (config-submode) #host?
  vlan                 IPv4 Address based on VLAN
  A.B.C.D              IPv4 Address of host
(host) [md] (config-submode) #host vlan ?
  <1-4094>             VLAN ID
(host) [md] (config-submode) #host vlan 55 ?
  offset              Offset in the VLAN subnet
(host) [md] (config-submode) #host vlan 55 offset ?
  <1-254>              Offset number in the VLAN subnet
(host) [md] (config-submode) #host vlan 55 offset 36
```

To show the local override netdestination

```
(host) [md] #show netdestination store
Name: store
Position Type      IP addr  Mask-Len/Range
-----
1          override vlan 55  offset 36
```

How to use the local-override netdestination alias in the managed device:

```
(host) [md] (config) #ip access-list session store-override
(host) [md] (config-sess-store-override) #any alias store any permit
(host) [md] (config-sess-store-override) #alias store any any deny
(host) [md] (config-sess-store-override) #!
(host) [md] #show ip interface brief
  Interface          IP Address / IP Netmask      Admin  Protocol
  vlan 1             172.72.10.254 / 255.255.255.0  up     up
  vlan 55            55.55.55.1 / 255.255.255.0    up     up
  loopback           unassigned / unassigned      up     up
(host) [md] #show acl acl-table | include store-override 81 session 744 2 3 store-
override 0
(host) [md] #show acl ace-table acl 81
  744: any 55.55.55.36 255.255.255.255 0 0-0 0-0 f80001:permit
  745: 55.55.55.36 255.255.255.255 any 0 0-0 0-0 f80000:deny
  746: any any 0 0-0 0-0 f180000:deny
```

## User Roles

User roles are comprised of user role settings, firewall policies, and bandwidth contracts. This section describes the procedure to create a new user role, and associate a firewall policy with that role.

This section describes how to create a new user role.

### In the WebUI

1. In the **Managed Device** node hierarchy, navigate to the **Configuration > Roles & Policies > Roles** tab on the WebUI.
2. Click **+** to create a new role.
3. Enter name for the new role and click **Submit**.
4. Select the role created and click **+** under **RULES FOR THIS ROLE ONLY** table.
5. Click one of the options in the **Rule Type** field to select a rule and click **OK**.
6. Click **Submit**.
7. Select one of the following options to add a policy to the role:
  - In the **Policies** tab select the role created and click **+** under the **Policies** table. Enter a name for the policy and select a policy type in the **Add Policy** pop up. Click **Submit**.
  - To associate an existing policy to a user role:
    - Select the **Role** and click **Show Advanced View** in **Roles <policy name>** table.
    - Click **+** under the **Policies** tab.
    - Select **Add an existing policy** option and select a policy from the **Policy name** drop-down list.
    - Click **Submit**.



---

For more information on creating a firewall policy, see [Configuring Firewall Policies on page 367](#).

---

8. (Optional) If the user role contains more than one firewall policy, use the up and down arrows to assign priorities to each role. The higher the policy on the list, the higher its priority.
9. Click **Show Advanced View** and enter the configuration values as described in [Table 66](#).
10. Click **Submit**.
11. Click **Pending Changes**.
12. In the **Pending Changes** window, select the check box and click **Deploy changes**.
13. Next, you must assign the user role to a AAA profile in the managed device. After assigning the user role you, execute the **show reference user-role <role>** command on the managed device to see the profiles that reference this role. For more information, see [Assigning User Roles on page 378](#)



**Table 66: User Role Parameters**

Field	Description
Name	Name of the user role.
Re-auth interval (optional)	Time, in minutes, after which the client is required to reauthenticate. Enter a value between 0-4096. 0 disables reauthentication.  Default: 0 (disabled)
VLAN (optional)	By default, a client is assigned a VLAN on the basis of the ingress VLAN for the client to the managed device. You can override this assignment and configure the VLAN ID that is to be assigned to the user role. You configure a VLAN by navigating to the <b>Configuration &gt; Roles &amp; Policies &gt; Roles</b> tab. Select a Role and click <b>Show Advanced View &gt; More &gt; Network</b> .
Bandwidth (optional)	You can assign a bandwidth contract to provide an upper limit to upstream or downstream bandwidth utilized by clients in this role. You can select the Per User option to apply the bandwidth contracts on a per-user basis instead of to all clients in the role.  For more information, see <a href="#">Configuring Bandwidth Contracts on page 393</a> .
VPN Dialer (optional)	This assigns a VPN dialer to a user role. For details about VPN dialer, see <a href="#">Virtual Private Networks on page 338</a> .  Select a dialer from the drop-down list and assign it to the user role. This dialer will be available for download when a client logs in using captive portal and is assigned this role.
L2TP Pool (optional)	This assigns an L2TP pool to the user role. For more details about L2TP pools, see <a href="#">Virtual Private Networks on page 338</a> .  Select the required L2TP pool from the list to assign to the user role. The inner IP addresses of VPN tunnels using L2TP will be assigned from this pool of IP addresses for clients in this user role.
PPTP Pool (optional)	This assigns a PPTP pool to the user role. For more details about PPTP pools, see <a href="#">Virtual Private Networks on page 338</a> .  Select the required PPTP pool from the list to assign to the user role. The inner IP addresses of VPN tunnels using PPTP will be assigned from this pool of IP addresses for clients in this user role.
Captive Portal Profile (optional)	This assigns a Captive Portal profile to this role. For more details about Captive Portal profiles, see <a href="#">Captive Portal Authentication on page 286</a> .
Captive Portal Check for Accounting	This setting is enabled by default. If disabled, RADIUS accounting is done for an authenticated users irrespective of the captive-portal profile in the role of an authenticated user. If enabled, accounting is not done as long as the user's role has a captive portal profile on it. Accounting will start when Auth/XML-Add/CoA changes the role of an authenticated user to a role which doesn't have captive portal profile.
Max Sessions	This parameter configures the maximum number of sessions per user in this role. If the sessions reach the maximum value, any additional sessions from this user that are reaching the threshold are blocked till the session usage count for the user falls back below the configured limit.  The default is 65535. You can configure any value between 0-65535.

To delete a user role in the WebUI:

1. In the **Managed Device** node hierarchy, navigate to the **Configuration > Roles & Policies > Roles** tab on the WebUI.
2. Select the **Role** and click the **Delete** icon.



---

You cannot delete a user-role that is referenced to profile or server derived role. Deleting a server referenced role will result in an error. Remove all references to the role and then perform the delete operation.

---

## In the CLI

The commands to associate an access control list (ACL) to a user role vary, depending upon the type of access control list being associated to that role. User roles are applied globally across all managed devices, so ethertype, MAC and session ACLs can be applied to global user roles. However, routing access lists may vary between locations, so they are mapped to a user role in a local configuration setting.

To associate the user role with an ethertype, MAC or session ACL, use the command **user-role <role> access-list eth|mac|session <acl>**. To associate a user role with a routing ACL, use the **routing-policy-map** command.

## Assigning User Roles

A client is assigned a user role by one of several methods. A role assigned by one method may take precedence over one assigned by a different method. The methods of assigning user roles are, from lowest to highest precedence:

1. The initial user role or VLAN for unauthenticated clients is configured in the AAA profile for a virtual AP (see [Access Points on page 496](#)).
2. The user role can be derived from user attributes upon the client's association with an AP (this is known as a user-derived role). You can configure rules that assign a user role to clients that match a certain set of criteria. For example, you can configure a rule to assign the role VoIP-Phone to any client that has a MAC address that starts with bytes `xx:yy:zz`. User-derivation rules are executed *before* client authentication.
3. The user role can be the default user role configured for an authentication method, such as 802.1X or VPN. For each authentication method, you can configure a default role for clients who are successfully authenticated using that method.
4. The user role can be derived from attributes returned by the authentication server and certain client attributes (this is known as a *server-derived role*). If the client is authenticated via an authentication server, the user role for the client can be based on one or more attributes returned by the server during authentication, or on client attributes such as SSID (even if the attribute is not returned by the server). Server-derivation rules are executed *after* client authentication.
5. The user role can be derived from Aruba Vendor-Specific Attributes (VSA) for RADIUS server authentication. A role derived from an Aruba VSA takes precedence over any other user roles.

The following sections describe the methods of assigning user roles.

### Assigning User Roles in AAA Profiles

An AAA profile defines the user role for unauthenticated clients (initial role) as well as the default user role for MAC and 802.1X authentication. For additional information on creating AAA profiles, see [WLAN Authentication on page 436](#).

## In the WebUI

1. In the **Managed Device** node hierarchy, navigate to **Configuration > Authentication > AAA Profiles** tab.
2. Select a AAA profile under **AAA Profiles**.
3. Select the default profile or a user-defined AAA profile.
4. Select the desired user role for unauthenticated users, from the **Initial Role** drop-down list.
5. Select the desired user role for users who have completed 802.1X authentication, from the **802.1X Authentication Default Role** drop-down list.
6. Select the desired user role for clients who have completed MAC authentication, from the **MAC Authentication Default Role** drop-down list.
7. Click **Submit**.
8. Click **Pending Changes**.
9. In the **Pending Changes** window, select the check box and click **Deploy changes**.

## In the CLI

```
(host) [md] (config) #aaa profile <profile-name>
```

## Working with User-Derived VLANs

Attributes derived from the client's association with an AP can be used to assign the client to a specific role or VLAN, as user-derivation rules are executed before the client is authenticated.

You configure the user role or VLAN to be assigned to the client by specifying condition rules; when a condition is met, the specified user role or VLAN is assigned to the client. You can specify more than one condition rule; the order of rules is important as the first matching condition is applied. You can optionally add a description of the user rule.

[Table 67](#) describes the conditions for which you can specify a user role or VLAN.

**Table 67:** *Conditions for a User-Derived Role or VLAN*

Rule Type	Condition	Value
BSSID: Assign client to a role or VLAN based upon the BSSID of AP to which client is associating.	One of the following: <ul style="list-style-type: none"><li>• contains</li><li>• ends with</li><li>• equals</li><li>• does not equal</li><li>• starts with</li></ul>	MAC address (xx:xx:xx:xx:xx:xx)
DHCP-Option: Assign client to a role or VLAN based upon the DHCP signature ID.	One of the following: <ul style="list-style-type: none"><li>• equals</li><li>• starts with</li></ul>	DHCP signature ID. <b>NOTE:</b> This string is <i>not</i> case sensitive.
DHCP-Option-77: Assign client to a role or VLAN based upon the user class identifier returned by DHCP server.	equals	string

Rule Type	Condition	Value
Encryption: Assign client to a role or VLAN based upon the encryption type used by the client.	One of the following: <ul style="list-style-type: none"> <li>• equals</li> <li>• does not equal</li> </ul>	<ul style="list-style-type: none"> <li>• Open System (no encryption)</li> <li>• WPA/WPA2 AES (static or dynamic)</li> <li>• WPA/WPA2-TKIP (static or dynamic)</li> <li>• WEP (static or dynamic)</li> <li>• xSec</li> </ul>
ESSID: Assign client to a role or VLAN based upon the ESSID to which the client is associated.	One of the following: <ul style="list-style-type: none"> <li>• contains</li> <li>• ends with</li> <li>• equals</li> <li>• does not equal</li> <li>• starts with</li> <li>• value of (does not take <i>string</i>; attribute value is used as role)</li> </ul>	string
Location: Assign client to a role or VLAN based upon the AP name to which the client is associated.	One of the following: <ul style="list-style-type: none"> <li>• equals</li> <li>• does not equal</li> </ul>	string
MAC address of the client	One of the following: <ul style="list-style-type: none"> <li>• contains</li> <li>• ends with</li> <li>• equals</li> <li>• does not equal</li> <li>• starts with</li> </ul>	MAC address (xx:xx:xx:xx:xx:xx)

## Understanding Device Identification

The device identification feature allows you to assign a user role or VLAN to a specific device type by identifying a DHCP option and signature for that device. If you create a user rule with the **DHCP-Option** rule type, the first two characters in the **Value** field must represent the hexadecimal value of the DHCP option that this rule should match, while the rest of the characters in the **Value** field indicate the DHCP signature the rule should match. To create a rule that matches DHCP option 12 (host name), the first two characters in the **Value** field must be the hexadecimal value of 12, which is 0C. To create a rule that matches DHCP option 55, the first two characters in the Value field must be the hexadecimal value of 55, which is 37.

The following table describes some of the DHCP options that are useful for assigning a user role or VLAN.

**Table 68:** DHCP Option values

DHCP Option	Description	Hexadecimal Equivalent
12	Host name	0C
55	Parameter Request List	37
60	Vendor Class Identifier	3C
81	Client FQDN	51

The device identification features in ArubaOS can also automatically identify different client device types and operating systems by parsing the User-Agent strings in the client's HTTP packets. To enable this feature, select the **Device Type Classification** option in the AP's AAA profile. For details, see [WLAN Authentication on page 436](#).

Starting from ArubaOS 8.0.1, the device type classification is enhanced to identify the device type for each client, determine firewall policies, and customize to meet the requirement of the end user. The device type information is sent from ClearPass to ArubaOS.



---

Prior to establishing the WebSocket interface with ClearPass Insight server the issuer certificate of the server must be imported to the controller as TrustedCA certificate.

---

To gather the information required to manage and establish WebSocket interface to the ClearPass Insight server, configure ClearPass WebSocket profile. Once the connection is established, the user can subscribe/unsubscribe and receive device profile information for the subscribed stations.



---

Only admin, apiadmin, and clusteradmin can configure ClearPass WebSocket profile.

---

### In the WebUI

Follow the steps below to configure the ClearPass WebSocket interface and the primary and secondary ClearPass Insight server:

1. In the **Mobility Master** node hierarchy, navigate to **Configuration > System > Profiles** tab.
2. From **All Profiles** select **Other Profiles > ClearPass WebSocket**.
3. Select ClearPass WebSocket Interface checkbox to enable this option and to connect to ClearPass WebSocket.
4. Enter appropriate values in the **host** and **port name** fields.
5. Enter appropriate values in the parameters listed below the **Primary ClearPass Insight Server** and **Secondary ClearPass Insight Server** fields.
6. Click **Submit**.
7. Click **Pending Changes**.
8. In the **Pending Changes** window, select the check box and click **Deploy changes**.

### In the CLI

Execute the following commands to configure the ClearPass WebSocket interface and the primary and secondary ClearPass Insight server:

```
(host) [mynode] (config) #websocket clearpass
(host) [mynode] (ClearPass WebSocket Profile) #primary host <host> port <1-65535> username
<username> passwd <passwd>
(host) [mynode] (ClearPass WebSocket Profile) #secondary host <host> port <1-65535> username
<username> passwd <passwd>
(host) [mynode] (ClearPass WebSocket Profile) #enable
```

Execute the following command to check the current connection state of the ClearPass WebSocket interface:

```
(host) [mynode] #show websocket state clearpass
```

Execute the following command to view the current statistics of ClearPass WebSocket interface:

```
(host) [mynode] #show websocket statistics clearpass
```

## Configuring a User-derived VLAN in the WebUI

1. In the **Managed Device** node hierarchy, navigate to **Configuration > Authentication > User Rules** tab.
2. Click **+** to add a new set of derivation rules. Enter a name for the set of rules, and click **Apply**. The name appears in the **User Rules Summary** list.
3. In the **User Rules Summary** list, select the name of the rule set to configure rules.
4. Click **+** in the **Rules-set** table to add a rule. Select **VLAN** from the **Set Type** drop-down list. (You can select **VLAN** to create derivation rules for setting the VLAN assigned to a client.)
5. Configure the condition for the rule by setting the **Rule type**, **Condition**, **Value** parameters and optional description of the rule. See [Table 67](#) for descriptions of these parameters.
6. Select the role assigned to the client when this condition is met.
7. Click **Submit**.
8. Click **Pending Changes**.
9. In the **Pending Changes** window, select the check box and click **Deploy changes**.
10. You can configure additional rules for this rule set. When you have added rules to the set, use the up or down arrows in the Actions column to modify the order of the rules. (The first matching rule is applied.)
11. (Optional) If the rule uses the DHCP-Option condition, best practices is to enable the Enforce DHCP parameter in the AP group's AAA profile, which requires users to complete a DHCP exchange to obtain an IP address. For details on configuring this parameter in an AAA profile, see [WLAN Authentication on page 436](#).

## Configuring a User-derived Role or VLAN in the CLI

```
(host) [md] (config) #aaa derivation-rules user <name>
```

## RADIUS Override of User-Derived Roles

This feature introduces a new RADIUS vendor specific attribute (VSA) named "Aruba-No-DHCP-Fingerprint," value 14. This attribute signals the RADIUS Client (managed device) to ignore the DHCP Fingerprint user role and VLAN change post L2 authentication. This feature applies to both CAP and RAP in tunnel mode and for the L2 authenticated role only.

## Configuring a Default Role for Authentication Method

For each authentication method, you can configure a default role for clients who are successfully authenticated using that method. To configure a default role for an authentication method:

### In the WebUI

1. In the **Managed Device** node hierarchy, navigate to **Configuration > Authentication > AAA Profiles** tab.
2. To configure the default user role for MAC or 802.1X authentication, select the **AAA Profiles** tab.

3. Select a AAA profile under **AAA Profiles** and select the desired user role for **MAC Authentication Default Role** or **802.1X Authentication Default Role**.
4. To configure the default user role for other authentication methods, select the **L2 Authentication** or **L3 Authentication** tab. Select the authentication type (Stateful 802.1X for L2 Authentication, Captive Portal or VPN Authentication for L3 Authentication), and then select the profile. Enter the user role for **Default Role**.
5. Click **Submit**.
6. Click **Pending Changes**.
7. In the **Pending Changes** window, select the check box and click **Deploy changes**.

For additional information on configuring captive portal authentication, see [Captive Portal Authentication on page 286](#).

### In the CLI

To configure the default user role for MAC or 802.1X authentication:

```
(host) [md] (config) #aaa profile <profile>
```

To configure the default user role for other authentication methods:

```
(host) [md] (config) #aaa authentication captive-portal|stateful-dot1x|stateful-ntlm|vpn
```

### Configuring a Server-Derived Role

If the client is authenticated through an authentication server, the user role for the client can be based on one or more attributes returned by the server during authentication. You configure the user role to be derived by specifying condition rules; when a condition is met, the specified user role is assigned to the client. You can specify more than one condition rule; the order of rules is important as the first matching condition is applied. You can also define server rules based on client attributes such as ESSID, BSSID, or MAC address, even though these attributes are not returned by the server.

For information about configuring a server-derived role, see [Configuring Server-Derivation Rules on page 196](#).

### Configuring a VSA-Derived Role

Many Network Address Server (NAS) vendors, including Aruba, use VSAs to provide features not supported in standard RADIUS attributes. For Aruba systems, VSAs can be employed to provide the user role and VLAN for RADIUS-authenticated clients, however the VSAs must be present on your RADIUS server. This involves defining the vendor (Aruba) and/or the vendor-specific code (14823), vendor-assigned attribute number, attribute format (such as string or integer), and attribute value in the RADIUS dictionary file. VSAs supported on managed devices conform to the format recommended in RFC 2865, "Remote Authentication Dial In User Service (RADIUS)".

For more information on Aruba VSAs, see [RADIUS Server VSAs on page 185](#). Dictionary files that contain Aruba VSAs are available on the Aruba support website for various RADIUS servers. Log into the Aruba support website to download a dictionary file from the Tools folder.

## Understanding Global Firewall Parameters

[Table 69](#) describes optional firewall parameters you can set on the managed devices for IPv4 traffic. To set these options in the WebUI, in the **Mobility Master** node hierarchy, navigate to the **Configuration > Services > Firewall > Global Settings** accordion and select or enter values in the IPv4 column. To set these options in the CLI, use the **firewall** configuration commands.

See [IPv6 Support on page 122](#) for information about configuring firewall parameters for IPv6 traffic.

**Table 69: IPv4 Firewall Parameters**

Parameter	Description
Monitor Ping Attack (per 30 seconds)	Number of ICMP pings per 30 second, which if exceeded, can indicate a denial of service attack. Valid range is 1-16384 pings per 30 seconds. Recommended value is 120 seconds. Default: No default
Monitor TCP SYN Attack rate (per 30 seconds)	Number of TCP SYN messages per 30 second, which if exceeded, can indicate a denial of service attack. Valid range is 1-16384 pings per 30 seconds. Recommended value is 960 seconds. Default: No default
Monitor IP Session Attack (per 30 seconds)	Number of TCP or UDP connection requests per 30 second, which if exceeded, can indicate a denial of service attack. Valid range is 1-16384 requests per 30 seconds. Recommended value is 960 seconds. Default: No default
Monitor/Police ARP Attack (non Gratuitous ARP) rate (per 30 seconds)	Number of ARP packets (other than Gratuitous ARP packets) per 30 seconds, which if exceeded, can indicate a denial of service attack. Valid range is 1-16384 packets per 30 seconds. Recommended value is 960 packets. Default: No default <b>NOTE:</b> Blacklisting of wired clients is not supported.
Monitor/Police CP Attack rate (per 30 seconds)	Rate of misbehaving user's traffic, which if exceeded, can indicate a denial or service attack. Recommended value is 3000 frames per 30 seconds. Default: No default
Monitor/Police Gratuitous ARP Attack rate (per 30 seconds)	Number of Gratuitous ARP packets per 30 seconds, which if exceeded, can indicate denial of service attack. Valid range is 1-16384 packets per 30 seconds. Recommended value is 50 packets. Default: 50 packets <b>NOTE:</b> Blacklisting of wired clients is not supported.
Deny Inter User Bridging	Prevents the forwarding of Layer-2 traffic between wired or wireless users. You can configure user role policies that prevent Layer-3 traffic between users or networks but this does not block Layer-2 traffic. This option can be used to prevent traffic, such as Appletalk or IPX, from being forwarded. Default: Disabled



Parameter	Description
Deny Inter User Traffic	Denies traffic between untrusted users by disallowing layer-2 and layer-3 traffic. This parameter does not depend on the deny-inter-user-bridging parameter being enabled or disabled.  Default: Disabled
Deny Source Routing	Permits the firewall to reject and log packets with the specified IP options loose source routing, strict source routing, and record route. Note that network packets where the IPv6 source or destination address of the network packet is defined as an "link-local address (fe80::/64) are permitted.  Default: Disabled
Deny All IP Fragments	Drops all IP fragments.  <b>NOTE:</b> Do not enable this option unless instructed to do so by an Aruba representative.  Default: Disabled
Enforce TCP Handshake Before Allowing Data	Prevents data from passing between two clients until the three-way TCP handshake has been performed. This option should be disabled when you have mobile clients on the network as enabling this option will cause mobility to fail. You can enable this option if there are no mobile clients on the network.  Default: Disabled
Prohibit IP Spoofing	Enables detection of IP spoofing (where an intruder sends messages using the IP address of a trusted client). When this option is enabled, source and destination IP and MAC addresses are checked for each ARP request/response. Traffic from a second MAC address using a specific IP address is denied, and the entry is not added to the user table. Possible IP spoofing attacks are logged and an SNMP trap is sent.  Default: Enabled
Prohibit RST Replay Attack	When enabled, closes a TCP connection in both directions if a TCP RST is received from either direction. You should not enable this option unless instructed to do so by an Aruba representative.  Default: Disabled
Log ICMP Errors	Enables logging of received ICMP errors. You should not enable this option unless instructed to do so by an Aruba representative.  Default: Disabled
Stateful SIP Processing	Disables monitoring of exchanges between a voice over IP or voice over WLAN device and a SIP server. This option should be enabled only when there is no VoIP or VoWLAN traffic on the network.  Default: Disabled (stateful SIP processing is enabled)

Parameter	Description
Allow Tri-session with DNAT	<p>Allows three-way session when performing destination NAT. This option should be enabled when the managed device is <i>not</i> the default gateway for wireless clients and the default gateway is behind the managed device. This option is typically used for captive portal configuration.</p> <p>Default: Disabled.</p>
AMSDU Configuration	<p>Enables handling AMSDU traffic from clients.</p> <p>Default: Disabled</p>
Session Mirror Destination	<p>Destination (IP address or port) to which mirrored session packets are sent. This option is used only for troubleshooting or debugging.</p> <p>Packets can be mirrored in multiple ACLs, so only a single copy is mirrored if there is a match within more than one ACL.</p> <p>You can configure the following:</p> <ul style="list-style-type: none"> <li>• Ethertype to be mirrored with the Ethertype ACL mirror option.</li> <li>• IP flows to be mirrored with the session ACL mirror option.</li> <li>• MAC flows to be mirrored with the MAC ACL mirror option.</li> <li>• If you configure both an IP address and a port to receive mirrored packets, the IP address takes precedence.</li> </ul> <p>Default: N/A</p>
Session Idle Timeout (sec)	<p>Set the time, in seconds, that a non-TCP session can be idle before it is removed from the session table. Specify a value in the range 16-259 seconds. You should not set this option unless instructed to do so by an Aruba representative.</p> <p>Default: 15 seconds</p>
Disable FTP Server	<p>Disables the FTP server on the managed device. Enabling this option prevents FTP transfers. You should not enable this option unless instructed to do so by an Aruba representative.</p> <p>Default: Disabled (FTP server is enabled)</p>
GRE Call ID Processing	<p>Creates a unique state for each PPTP tunnel. You should not enable this option unless instructed to do so by an Aruba representative.</p> <p>Default: Disabled</p>
Per-packet Logging	<p>Enables logging of every packet if logging is enabled for the corresponding session rule. Normally, one event is logged per session. If you enable this option, each packet in the session is logged. You should not enable this option unless instructed to do so by an Aruba representative, as doing so may create unnecessary overhead on the managed device.</p> <p>Default: Disabled (per-session logging is performed)</p>
Broadcast-filter ARP	<p>Reduces the number of broadcast packets sent to VoIP clients, thereby improving the battery life of voice handsets. You can enable this option for voice handsets in conjunction with increasing the DTIM interval on</p>

Parameter	Description
	clients. Default: Disabled
Prohibit ARP Spoofing	Detects and prohibits ARP spoofing. When this option is enabled, possible arp spoofing attacks are logged and an SNMP trap is sent. Default: Disabled
Prevent DHCP Exhaustion	Enable check for DHCP client hardware address against the packet source MAC address. This command checks the frame's source-MAC against the DHCPv4 client hardware address and drops the packet if it does not match. Enabling this feature prevents a client from submitting multiple DHCP requests with different hardware addresses, thereby preventing DHCP pool depletion. Default: Disabled
Session VOIP Timeout (sec)	Sets the idle session timeout for sessions that are marked as voice sessions. If no voice packet exchange occurs over a voice session for the specified time, the voice session is removed. Range is 16 – 300 seconds. Default: 300 seconds
Stateful H.323 Processing	Disables stateful H.323 processing. Default: Enabled
Stateful SCCP Processing	Disables stateful SCCP processing. Default: Disabled
Only Allow Local Subnets in User Table	Adds only IP addresses, which belong to a local subnet, to the user-table. Default: Disabled
Session Mirror IPSEC	Configures session mirroring of all frames that are processed by IPsec. Frames are sent to IP address specified by the session-mirror-destination option. <b>NOTE:</b> Use this option for debugging or troubleshooting only. Default: Disabled
Session-tunnel FIB	Enable session-tunnel based forwarding. <b>NOTE:</b> Best practices is to enable this parameter only during maintenance window or off-peak production hours.
Multicast Automatic Shaping	Enables multicast optimization and provides excellent streaming quality regardless of the amount of VLANs or IP IGMP groups that are used. Default: Disabled
Stateful VOCERA Processing	Disables stateful VOCERA processing.

Parameter	Description
	Default: Disabled
Stateful UA Processing	Disables stateful UA processing. Default: Disabled
Enforce BW Contracts for Broadcast Traffic	Applies bw contracts to local subnet broadcast traffic.
Enforce TCP Sequence Numbers	Enforces the TCP sequence numbers for all packets. Default: Disabled
Enforce WMM Voice Priority Matches Flow Content	If traffic to or from the user is inconsistent with the associated QoS policy for voice, the traffic is reclassified to best effort and data path counters incremented. Default: Disabled
Rate Limit CP Untrusted Uucast Traffic (pps)	Specifies the untrusted unicast traffic rate limit. Range is 1-65535 packets per seconds (pps). Default: 9765 pps
Rate Limit CP Untrusted Mcast Traffic (pps)	Specifies the untrusted multicast traffic rate limit. Range is 1-65535 packets per seconds (pps). Default: 1953 pps
Rate Limit CP Trusted Ucast Traffic (pps)	Specifies the trusted unicast traffic rate limit. Range is 1-65535 packets per seconds (pps). Default: 65535 pps
Rate Limit CP Trusted Mcast Traffic (pps)	Specifies the trusted multicast traffic rate limit. Range is 1-65535 packets per seconds (pps). Default: 1953 pps
Rate Limit CP Route Traffic (pps)	Specifies the traffic rate limit that needs ARP requests. Range is 1-65535 packets per seconds (pps). Default: 976 pps
Rate Limit CP Session Mirror Traffic (pps)	Specifies the session mirrored traffic forwarded to the managed device. Range is 1-65535 packets per seconds (pps). Default: 976 pps
Rate Limit CP Auth Process Traffic (pps)	Specifies the traffic rate limit that is forwarded to the authentication process. Range is Range is 1-65535 packets per seconds (pps). Default: 976 pps

## Working in the Presence of Web Proxy

When the Mobility Master needs to access data on the cloud or the internet, and if the internet bound traffic needs to pass through a proxy, execute the **web-proxy server** command. Once the command is executed the Mobility Master routes web (HTTP/HTTPS) traffic through the proxy server.

### In the CLI

Execute the following command in the CLI to route web traffic through the proxy server:

```
(host) [mynode] (config) #web-proxy server arubaproxy.com port 8080
(host) [mynode] (config) #show web-proxy
      Server: arubaproxy.com
      port: 8080
```

## Support for Desktop Virtualization Protocols

ArubaOS supports desktop virtualization protocols by providing preconfigured ACLs for Citrix and VMware clients. You can apply these ACLs to the user-role when using the Virtual Desktop Infrastructure (VDI) clients. This ensures that any enterprise application that uses the VDI client performs optimally with appropriate QoS.



---

Disable the voice aware ARM when applying the ACLs for the VDI clients as the virtual desktop sessions may prevent the ARM scanning.

---

## AppRF 2.0

The AppRF 2.0 feature improves application visibility and control by allowing you to configure access control list (ACL) and bandwidth-control applications and application categories. AppRF 2.0 supports a Deep Packet Inspection (DPI) engine for application detection for over a thousand applications. All wired and wireless traffic that traverses the managed device can now be categorized and controlled by application and application category.

AppRF 2.0 provides the ability to:

- permit or deny an application or application category for a specific role. For example, you can block bandwidth monopolizing applications on a guest role within an enterprise.
- rate limit an application or application category, such as video streaming applications, globally or for a specific role.
- mark different L2/L3 Quality of Service (QoS) for an application or application category for a user role. For example, you can mark video and voice sessions that originate from wireless users with different priorities so that traffic is prioritized accordingly in your network.
- support for upgrading application signatures.
- define custom applications and custom application categories.

To configure AppRF 2.0, see the following topics:

- [Enabling Deep Packet Inspection on page 390](#)
- [Configuring Policies for AppRF 2.0 on page 390](#)
- [Configuring Bandwidth Contracts on page 393](#)
- [Upgrading Application Signatures on page 394](#)
- [Defining Custom Application on page 395](#)

## Enabling Deep Packet Inspection

For application and application category specific configuration to take effect, you must first enable Deep Packet Inspection (DPI).



---

You must reboot (reload) the managed device after you enable or disable DPI for global classification to take effect.

---

### In the WebUI

1. In the **Mobility Master** node hierarchy, navigate to **Configuration > Services > Firewall** tab.
2. Click **Global Settings** accordion.
3. Select **Enabled** from the **Enable deep packet inspection** drop-down list. To disable DPI, select **Disabled** from the drop-down list.
4. Click **Submit**.
5. Click **Pending Changes**.
6. In the **Pending Changes** window, select the check box and click **Deploy changes**.
7. Reload the Mobility Master.

### In the CLI

To enable global DPI:

```
(host) [mynode] (config) #firewall dpi
(host) [mynode] #reload
```

To display the application ID, application name, and the ACL/ACE index information for a given session:

```
(host) [mynode] #show datapath session dpi
```

## Configuring Policies for AppRF 2.0

Access control lists now contain new application and application category options that let you permit or deny an application or application category on a given role. See the Dashboard Monitoring [Traffic Analysis](#) topic for details about configuring policies from the Dashboard.

### How ACL Works with AppRF

A session entry proceeds through two phases: the application detection phase (phase 1) and the post-application detection phase (phase 2). A session ACL is applied in phase1 and in phase 2.

In phase1, if the session ACL lookup results in an L3/L4 ACE entry request, the traffic pertaining to the session is guided by this L3/L4 ACE entry. However, if the session ACL lookup results in an application/application category specific ACE entry, the enforcement is postponed until phase 2. Once the application is determined, the session ACL is re-applied with "application/application category" information to determine the final action on the traffic.

### Global Session ACL

The Global Session ACL is used to configure ACL rules that span across or are common to all roles. They are applied to all roles. The global-sacl rules take precedence over any other ACLs that may be in the user role.

The global-sacl session ACL by default, is in position one for every user role configured on the managed device. The global-sacl session ACL has the following properties:

- It cannot be deleted.
- It always remains at position one in every role and its position cannot be modified.
- It contains only application rules.

- It can be modified in the WebUI, CLI, and dashboard on a Mobility Master.
- Any modifications to it results in the regeneration of ACE's of all roles.

### Role Default Session ACL

You can configure role-specific application configuration using the WebUI and dashboard. For example, you can deny the facebook application on the guest role using the CLI or dashboard without having to change the firewall configuration. This per-user role configuration from WebUI or Dashboard is placed in the Role Default Session ACL.

A new role session ACL named `apprf-“role-name”-sacl` has been added. This session, by default, is in position two for every user role configured on the managed device.

The string "apprf" is added to the beginning and "sacl" to the end of a role's name to form a managed device unique name for role default session ACL. This session ACL is in position two of the given user role after the global session ACL and takes the next higher priority after global policy rules.

The predefined role session ACL has the following properties:

- It cannot be deleted through the WebUI or CLI. It is only deleted automatically when the corresponding role is deleted.
- It always remains at position 2 in every role and its position cannot be modified.
- It contains only application rules.
- It can be modified using the WebUI, CLI, or dashboard on a Mobility Master, however any modification results in the regeneration of ACE's for that role.
- It cannot be applied to any other role.

Each application has an implicit set of ports that are used for communication. In phase 1, if an application ACE entry is hit, the traffic matching this application's implicit port is allowed (as governed by the application ACE). The DPI engine can monitor the exchange on these ports and determine the application. Once the application is determined, phase 2 occurs when an evaluation is done to determine the final outcome for the session.

### Example

This example shows a DPI rule along with a L3/L4 rule with forwarding action in the same ACL. Both ACL policies can be applied to a single user role.

#### ACL Policy "AppRules", Policy Type: Session

- Rule 1
  - source: any
  - destination: any
  - service/application: application facebook
  - action: permit
  - TOS value: 45
- Rule 2:
  - source: any
  - destination: any
  - service/application: application YouTube
  - action: deny
- Rule 3:
  - source: any
  - destination: any

- service/application: application category peer-to-peer
  - action: deny
- Rule 4:
  - source: any
  - destination: any
  - service/application: TCP 23
  - action: permit
- Rule 5:
  - source: network 40.1.0.0/16
  - destination: any
  - service/application: TCP 80
  - action: permit
  - TOS: 60
- Rule 6:
  - source: network 20.1.0.0/16
  - destination: any
  - service/application: TCP 80
  - action: source-nat

#### **ACL Policy "NetRules", Policy Type: Session**

- Rule 1
  - source: network 80.0.0.0/24
  - destination: any
  - service/application: TCP 80
  - action: deny
- Rule 2:
  - source: network 60.0.0.0/24
  - destination: any
  - service/application: TCP 80
  - action: dual-nat <nat\_pool>
- Rule 3:
  - source: network 10.0.0.0/24
  - destination: any
  - service/application: TCP 80
  - action: destination nat

#### **In the WebUI**

1. In the **Managed Device** node hierarchy, navigate to the **Configuration > Roles & Policies > Policies** tab on the WebUI.
2. Click **+** to create a new policy.
3. Select the policy created and click **+**.
4. Select **Access Control** option in the **Rule Type** field.
5. Click **OK**.
6. Select IPv4 or IPv6 from the **IP version** drop-down list.



7. Select Service from the **Service** drop-down list and an alias from the **Service alias** drop-down list.
8. Click **Submit**.
9. Click **Pending Changes**.
10. In the **Pending Changes** window, select the check box and click **Deploy changes**.

### In the CLI

To configure the ACL application-specific parameters using the command-line interface, access the command-line interface in config mode, run the following commands:

```
(host) [md] (config) #ip access-list
```

## Configuring Bandwidth Contracts

Bandwidth contract configuration lets you configure bandwidth contracts for both the global or application-specific levels.

### Global Bandwidth Contract Configuration

To configure bandwidth contracts to limit application and application categories on an application or global level, or to show global bandwidth contract configuration output, access the command-line interface and use the commands **dpi global-bandwidth-contract** and **show dpi global-bandwidth-contract**.

```
[host] [md] (config) #dpi global-bandwidth-contract [app|appcategory]
[host] [md] #show dpi global-bandwidth-contract
```

### Role-Specific Bandwidth Contracts

Application-specific bandwidth contracts (unlike "generic" bandwidth-contracts) allow you to control or reserve rates for specific applications only on a per-role basis. An optional exclude list is provided that allows you to exclude applications or application categories on which a generic user/role bandwidth-contract is not applied.

#### Using an Exclude List

Use an exclude to give specific enterprise mission-critical applications priority over other user traffic. An enterprise may have well known applications such as Microsoft Exchange, SAP, Oracle, accounting and finance applications, and other enterprise resource planning (ERP) or customer relationship management (CRM) applications.

Instead of enumerating bandwidth limits for each application individually on a per-user/per-role basis, you can configure a single bandwidth contract on a per-user/per-role to limit all non-mission critical applications. You can then exclude all mission-critical applications by placing them in an exclude list. This way all mission-critical applications will not be rate-limited. Important points regarding bandwidth contracts include:

- Application bandwidth contracts are per-role by default.
- When an application bandwidth-contract is configured for both a category and an application within the category, always apply the most specific bandwidth contract.

### In the WebUI

1. In the **Managed Device** node hierarchy, navigate to **Configuration > Roles & Policies > Roles** tab.
2. Click **+** to create a new user role or select a role from the **Roles** table to modify an existing role.
3. Click **Show Advanced View**.
4. Select the **Bandwidth** tab.
5. Click **+** under **Pre-Application Limits for This Role** accordion to add an application or application category to a bandwidth contract.
  - a. Select the application bandwidth type from the **Type** drop-down list.
  - b. Select the name of the bandwidth contract from the Name drop-down list.

- c. Enter values in Kbits/Mbits in the **Upstream** and **Downstream** fields.
  - d. Click **Submit**.
6. Click + under **Pre-Application Limit Exceptions for This Role** accordion to add an exception.
    - a. Select a value from the **Type** drop-down list.
    - b. Select an application / application category from the **Name** drop-down list.
    - c. Click **Submit**.
  7. Click **Show Advanced View** to configure additional parameters.




---

Make sure that the **Enable Deep Packet Inspection** option is checked.

---

8. Click **Submit**.
9. Click **Pending Changes**.
10. In the **Pending Changes** window, select the check box and click **Deploy changes**.

### In the CLI

To configure the bandwidth application-specific parameters using the CLI, access the command-line interface in config mode, and issue the following commands:

```
(host) [md] (config)# user-role <string>
(host) [md] (config-role)# bw-contract exclude
```

## Upgrading Application Signatures

Qosmos provides an upgraded app set library to Aruba. This is integrated in to the ArubaOS image. This is provided to the user as a Aruba-certified **proto bundle** file. The user can copy this file to Mobility Master flash and activate the **proto bundle** file using the command **dpi proto-bundle activate <filename>**

The **proto bundle** file activation is available only from CLI.

This ensures that managed device is able to recognize the latest app set dynamically.




---

The proto bundle file activation must be done under managed device.

---

In a typical Mobility Master deployment, if the managed device is running a higher version of the proto bundle , then upgrade with a lower version will not take effect.

## Protocol Database Image Upgrade

The procedure for protocol database image upgrade is as follows:

1. Qosmos DPI IxEngine provides a new protocol library to Aruba.
2. Aruba uses this to create a Aruba-certified **proto bundle** file, which is provided to the user.
3. User copies this to the Mobility Master flash.
4. Under the managed device, activate the **proto bundle** file using the **dpi proto-bundle activate <filename>** command.




---

If you are running ArubaOS 8.0.0.0, do not upgrade the QOSMOS application set library to the latest proto bundle.

---

## Defining Custom Application

A custom application can be created on the fly. Creating custom applications is supported on the managed device. This facilitates the user to apply roles and policies, and BW contracts to the custom applications. Custom applications can be associated with custom application categories.

A maximum of 64 custom applications can be created. In each custom application, a maximum of 16 rules can be applied. A custom application can be deleted only after deleting all the rules applied on it.



---

Starting from ArubaOS 8.0.1, when a custom application is added, modified, or deleted, it takes 2 minutes for the changes to take effect.

---

### In the WebUI

To create a custom application, perform the following steps:

1. In the **Managed Device** node hierarchy, navigate to the **Configuration > Roles & Policies > Applications** tab.
2. Click the **Custom Application** accordion.
3. Click **+** to create a custom application.
4. For **Name**, enter the name for the custom application.
5. For **Application ID**, enter a number between 1 and 64.
6. Select a **Category** from the drop-down list, if required.
7. For **Server name**, click **+**. In the **Add Server** window:
  - a. Enter the **Server name**.
  - b. Enter the **URI**.
  - c. Click **OK**.
8. For **Referer name**, click **+**. In the **Add Referer** window:
  - a. Enter the **Referer name**.
  - b. Click **OK**.
9. For **Common name**, click **+**. In the **Add Common Server** window:
  - a. Enter the **Common name**.
  - b. Click **OK**.
10. Click **Submit**.
11. Click **Pending Changes**.
12. In the **Pending Changes** window, select the check box and click **Deploy changes**.

### In the CLI

The following commands are used to create a new custom application on the Mobility Master and pushed to the managed device:

- http host/server name based application

```
(host) [md] (config) dpi custom-app <appname> <appID>
(host) [md] (config-submode) #http <hostname>
```
- http referrer based application

```
(host) [md] (config) dpi custom-app <appname> <appID>
(host) [md] (config-submode) #http referer-param <referrer>
```



---

Ensure that you enter only the domain name of the application for **<referrer>**.

---

- http server name and uri based application
 

```
(host) [md] (config) dpi custom-app <appname> <appID>
(host) [md] (config-submode) #http <hostname-param> <hostname> uri-param <uri>
```
- https common name based application
 

```
(host) [md] (config) dpi custom-app <appname> <appID>
(host) [md] (config-submode) #https common-name <common-name>
```




---

Enter the common name of the server certificate of the application. **<app id>** is a number between 1 and 64.

---

## Debugging

The following **show** commands are introduced as part of the custom application feature:

- Issue the following commands on the Mobility Master:
  - **show dpi custom-app all**: Displays output of custom applications
  - **show dpi custom-app <appname>**: Displays the rules of custom applications.
- Issue the following commands on the managed device:
  - **show dpi custom-app all** : Displays output of custom applications.
  - **show dpi custom-app <appname>**: Displays the rules of custom applications.
  - **show dpi application custom-app all**: Displays the custom application port information and DPI application id of all the custom applications.
  - **show dpi application custom-app <appname>**: Displays the custom application port information and DPI application ID of a particular custom application .

## Defining Custom Application Category

Creating user-defined custom application categories is supported on the Mobility Master. This will enable to customers to apply a policy for this category so that multiple custom applications associated with this category can receive the same policy.

A maximum of 32 custom application categories can be created.




---

Standard applications cannot be associated with custom application categories. Only custom applications can be associated with custom application categories. By default, custom applications fall under web category.

---

## In the WebUI

To create a custom application category, perform the following steps:

1. In the **Managed Device** node hierarchy, navigate to the **Configuration > Roles & Policies > Applications** tab.
2. Click the **Custom Application** accordion.
3. Click **+** to create a custom application.
4. In **Category**, click **+**.
5. In the **Application Categories** window, click **+** to create a custom application category.
6. In the **Application Categories > New Category** table:
  - a. For **Name**, enter the name for the custom application category.
  - b. For **Application ID**, enter a number between 1 and 32.
  - c. (Optional) For **Application**, select the check box next to the list of custom applications to associate with the category. Multiple custom applications can also be selected.



---

The **Application** list with check box appears only if custom applications are already created.

---

d. Click **Submit**.

The new custom category is now available in the **Category** drop-down list.

7. Click **Submit**.

8. Click **Pending Changes**.

9. In the **Pending Changes** window, select the check box and click **Deploy changes**.

To associate a custom application with a custom application category:

### In the CLI

Define the application category using the following command:

```
(host) [md] (config) #dpi appcategory <appcategory> <categoryId>
```

**categoryId** is a number between 1 and 32.

Associate the application category to a custom-application using the following commands:

```
(host) [md] (config) #dpi custom-app <appname> <appID>
(host) [md] (config-submode) #appcategory <appcategory>
(host) [md] (config-submode) #end
```

### Debugging

The following **show** commands are introduced as part of the custom application category feature:

- Issue the following command on the Mobility Master:
  - **show dpi application category user-defined all**: Displays custom app categories.
- Issue the following commands on the managed device:
  - **show dpi application category user-defined all**: Displays all custom application categories.
  - **show dpi application category user-defined <category-name>**: Displays the custom applications which associated to a particular custom application category.

ArubaOS and ClearPass Policy Manager include support for centralized policy definition and distribution. ArubaOS now supports downloadable roles. By using this feature, when ClearPass Policy Manager successfully authenticates a user, the user is assigned a role by ClearPass Policy Manager. If the role is not defined on the Mobility Master, the role attributes can also be downloaded automatically.

This chapter contains the following sections:

- [Introduction on page 398](#)
- [Important Points to Remember on page 398](#)
- [Enabling Downloadable Role on a Managed Device on page 399](#)
- [Sample Configuration on page 399](#)

## Introduction

In order to provide highly granular per-user level access, user roles can be created when a user has been successfully authenticated. During the configuration of a policy enforcement profile in ClearPass Policy Manager, the administrator can define a role that should be assigned to the user after successful authentication. In RADIUS authentication, when ClearPass Policy Manager successfully authenticates a user, the user is assigned a role by ClearPass Policy Manager. If the role is not defined on Mobility Master, the role attributes can also be downloaded automatically. This feature supports roles obtained by the following authentication methods:

- 802.1X (wireless and wired users)
- MAC authentication
- Captive Portal

## Important Points to Remember

- Under **Advanced** mode, ClearPass Policy Manager does not perform any error checking to confirm accuracy of the role definition. Therefore, it is recommended that you review the role defined in ClearPass Policy Manager prior to enabling this feature.
- The attributes that are listed below, herein referred to as whitelist role attributes, can be defined in ClearPass Policy Manager.:
  - **netdestination**
  - **netservice**
  - **ip access-list eth**
  - **ip access-list mac**
  - **ip access-list session**
  - **user-role**
- The above attributes that are referred to by a role definition must either be defined within the role definition itself or configured on the Mobility Master before the policy is downloaded.
- In ClearPass Policy Manager, two or more attributes (as listed above) should not have the same name. The following example is considered invalid, as both the attributes use **test** as the profile/net destination name:

```
qos-profile test
netdestination test
```

- Instance names (name of a whitelist role attribute) are case-sensitive. Attributes must adhere to the following rules:
  - Should not match any CLI option nested under a command from the whitelist.
  - Should not contain a number or a combination of numbers.
  - Should not contain any periods '.'.
  - Should not contain any spaces.

The example below is considered an invalid configuration and prevents ClearPass Policy Manager role download on a managed device:

```
netservice 'tcp' tcp 443
```

The first instance of **tcp** is a user-defined field, while the second is an operator of the **netservice** command. This violates the first rule.

```
netdestination 'alias'
```

The user-defined name **alias** is also a valid operator of the **netdestination** command. This violates the first rule.

```
netdestination '10.1.5'
```

This user-defined name uses both numbers and periods. This violates the second and third rule.

```
ip access-list stateless '100'
```

This user-defined name uses numbers. This violates the second rule.

```
qos-profile emp role
```

This profile name **emp role** contains spaces. This violates the fourth rule.

It is recommended that some naming convention similar to the CamelCase (mixture of upper and lower case letters in a single word) be used to avoid collisions with the CLI options in the role description.

## Enabling Downloadable Role on a Managed Device

You can enable role download using the CLI or WebUI.

### Using the WebUI

1. In the **Managed Network** node hierarchy, navigate to the **Configuration > Authentication** page.
2. Select the **AAA Profiles** tab
3. Expand **AAA** in the **AAA Profiles** list, and then select a **AAA** profile.
4. Select the **Download Role from CPPM** check box to enable role download.
5. Click **Save**.
6. Select **Pending Changes**.
7. In the **Pending Changes** window, select the check box and click **Deploy changes**.

### Using the CLI

```
(host) [md] (config) #aaa profile <profile-name>
(host) [md] (AAA profile) #download-role
```

## Sample Configuration

The following example shows the configuration details to integrate ClearPass Policy Manager server with a managed device to automatically download roles.

## ClearPass Policy Manager Server Configuration

### Adding a Device

1. Navigate to the **Configuration > Network > Devices** page in the ClearPass Policy Manager server.
2. Click **Add** above the **Network Devices** list. The **Add Device** page opens.
3. Under the **Device** tab, enter the **Name, IP or Subnet Address**, and **RADIUS Shared Secret** fields. Keep the rest of the fields as default.
4. Click **Add**.

The fields are described in [Table 70](#).

**Table 70:** *Device Tab*

Container	Description
Name	The name or identity of the device.
IP or Subnet Address	The IP address or subnet (example 10.1.1.1/24) of the device.
RADIUS Shared Secret	Enter and confirm a Shared Secret for each of the two supported request protocols.

### Adding an Enforcement Profile

1. Navigate to the **Configuration > Enforcement > Profiles** page.
2. Click **Add** above the **Enforcement Profiles** list. The **Enforcement Profiles** page opens.
3. Under the **Profile** tab, select **Aruba Downloadable Role Enforcement** from the **Template** drop-down list.
4. Enter the **Name** of the enforcement profile.
5. Under **Role Configuration Mode**, select **Advanced**. Keep the rest of the fields as default.
6. Click **Next**.

For the rest of the configuration, see [Advanced Role Configuration Mode](#).

The fields are described in [Table 71](#).

**Table 71:** *Enforcement Profiles Page*

Container	Description
Template	Policy Manager comes pre-packaged with several enforcement profile templates. In this example, select <b>Aruba Downloadable Role Enforcement - RADIUS</b> template that can be filled with user role definition to create roles that can be assigned to users after successful authentication.
Name	The name of the enforcement profile.
Role Configuration Mode	<b>Standard:</b> Configures the enforcement profile role using standard mode. <b>Advanced:</b> Configures the enforcement profile role using advanced mode.



## Advanced Role Configuration Mode

1. Under the **Attributes** tab, select **Radius:Aruba** from the **Type** table.
2. From the **Name** drop-down list, select **Aruba-CPPM-Role**.
3. In the **Value** field, enter the attribute for the downloadable-role.
4. Click the **Save** icon to save the attribute.
5. Click **Save** to save the enforcement profile.

The fields are described in [Table 72](#).

**Table 72:** *Enforcement Profiles Attributes Tab*

Container	Description
Type	Any RADIUS vendor dictionary that is pre-packaged with Policy Manager, or imported by the Administrator. This field is pre-populated with the dictionary names.
Name	The name of the attribute from the dictionary selected in the Type field. The attribute names are pre-populated from the dictionary.
Value	The attribute for the downloadable role. You can enter free-form text to define the role and policy. <b>NOTE:</b> The maximum limit for free form text is 16,000 bytes.

## Adding Enforcement Policy

1. Navigate to the **Configuration > Enforcement > Policies** page.
2. Click **Add** above the **Enforcement Policies** list. The **Enforcement Policies** page opens.
3. Under the **Enforcement** tab, enter the **Name** of the enforcement policy.
4. From the **Default Profile** drop-down list, select **[Deny Access Profile]**.  
Keep the rest of the fields as default.
5. Click **Next**.

The fields are described in [Table 73](#).

**Table 73:** *Enforcement Policies Enforcement Tab*

Container	Description
Name	The name of the enforcement policy.
Default Profile	An Enforcement Policy applies Conditions (roles, health, and time attributes) against specific values associated with those attributes to determine the Enforcement Profile. If none of the rules matches, Policy Manager applies the Default Profile.  See <a href="#">Adding an Enforcement Profile on page 400</a> to add a new profile.

6. Under the **Rules** tab, click **Add Rule**. The **Rules Editor** page opens.
7. Select **Click to add...** from the **Conditions** section. Select the appropriate values, and then click the **Save** icon.

- In the **Enforcement Profiles** section, select the RADIUS enforcement profile that you created in [Adding an Enforcement Profile on page 400](#) from the **Profile Names** drop-down list.
- Click **Save**.

The fields are described in [Table 74](#).

**Table 74:** *Enforcement Policies Rules Editor*

Container	Description
Type	The rules editor appears throughout the Policy Manager interface. It exposes different namespace dictionaries depending on Service type. When working with service rules, you can select <b>Authentication</b> namespace dictionary
Name	Drop-down list of attributes present in the selected namespace. In this example, select <b>Source</b> .
Operator	Drop-down list of context-appropriate (with respect to the attribute) operators. In this example, select <b>EQUALS</b> .
Value	Drop-down list of the Authentication source database. In this example, select <b>[Local User Repository]</b> .
Profile Names	Name of the RADIUS enforcement profile.

## Adding Services

- Navigate to the **Configuration > Services** page.
- Click **Add** above the **Services** list.
- Under the **Service** tab, select **802.1X Wired** from the **Type** drop-down-list.
- In the **Name** field, enter the name of the service.  
Keep the rest of the fields as default.
- Click **Next**.

The fields are described in [Table 75](#).

**Table 75:** *Service Tab*

Container	Description
Type	The service type. In this example, select <b>802.1X Wired</b> .
Name	The name of the service.

- Under the **Authentication** tab, select **[Local User Repository] [Local SQL DB]** from the **Authentication Sources** drop-down list.  
Keep the rest of the fields as default.
- Click **Next** twice.
- Under the **Enforcement** tab, select the enforcement policy that you created in [Adding Enforcement Policy on page 401](#) from the **Enforcement Policy** drop-down list.  
Keep the rest of the fields as default.
- Click **Save**.

For more configuration details on ClearPass Policy Manager, see the *ClearPass Policy Manager User Guide*.

## Managed Device Configuration

For additional command parameters, see the *ArubaOS CLI Reference Guide*.

### Configuring ClearPass Policy Manager Server on a Managed Device

```
(host) [md] (config) #aaa authentication-server radius cppm_server
(host) [md] (RADIUS Server "cppm_server") #host <ip_address_of_
  cppm_server>
(host) [md] (RADIUS Server "cppm_server") #key <psk>
(host) [md] (RADIUS Server "cppm_server") #cppm username <username>
  password <password>
```

### Configuring Server Group to include ClearPass Policy Manager Server

```
(host) [md] (config) #aaa server-group cppm_grp
(host) [md] (server group "cppm_grp") #auth-server cppm_server
```

### Configuring 802.1X Profile

```
(host) [md] (config) #aaa authentication dot1x cppm_dot1x_prof
```

### Configuring AAA Profile

```
(host) [md] (config) #aaa profile cppm_aaa_prof
(host) [md] (AAA Profile "cppm_aaa_prof") #authentication-dot1x cppm_
  dot1x_prof
(host) [md] (AAA Profile "cppm_aaa_prof") #dot1x-server-group cppm_grp
  (AAA Profile "cppm_aaa_prof") #download-role
```

### Show AAA Profile

```
(host) [md] #show aaa profile cppm_aaa_prof
  AAA Profile "cppm_aaa_prof"
  -----
  Parameter                               Value      Set
  -----
  Initial role                             logon
  MAC Authentication Profile                N/A
  MAC Authentication Default Role           guest
  MAC Authentication Server Group           default
  802.1X Authentication Profile             N/A
  802.1X Authentication Default Role        guest
  802.1X Authentication Server Group        N/A
  Download Role from CPPM                   Disabled
  Set username from dhcp option 12          Disabled
  L2 Authentication Fail Through            Disabled
  Multiple Server Accounting                Disabled
  User idle timeout                         N/A
  Max IPv4 for wireless user                2
  RADIUS Accounting Server Group            N/A
  RADIUS Interim Accounting                 Disabled
  XML API server                            N/A
  RFC 3576 server                           N/A
  User derivation rules                     N/A
  Wired to Wireless Roaming                 Enabled
  Device Type Classification                Enabled
  Enforce DHCP                              Disabled
  PAN Firewall Integration                   Disabled
  Open SSID radius accounting                Disabled
```

APs advertise WLANs to wireless clients by sending out beacons and probe responses that contain the WLAN's SSID and supported authentication and data rates. When a wireless client associates to an AP, it sends traffic to the AP's Basic Service Set Identifier (BSSID) which is usually the AP's MAC address.

In the Aruba network, an AP uses a unique BSSID for each WLAN, so each individual AP or AP group can support multiple WLAN configurations.

This chapter describes the following topics for creating and managing WLANs and Virtual AP profiles:

- [Basic WLAN Configuration Workflow on page 404](#)
- [WLAN Configuration Profiles on page 410](#)
- [Configuring the Virtual AP Profile](#)
- [Radio Resource \(802.11k\) and BSS Transition Management \(802.11v\) on page 420](#)
- [Fast BSS Transition \(802.11r\) on page 428](#)
- [WLAN SSID Profiles on page 429](#)
- [WLAN Authentication on page 436](#)

## Basic WLAN Configuration Workflow

The recommended method for creating a new WLAN configuration is through the new WLAN wizard, although advanced users may also configure a WLAN manually via the ArubaOS WebUI and command-line interfaces.

### Creating a WLAN using the WLAN Wizard

To start the New WLAN wizard, in the **Mobility Master** node hierarchy, navigate to **Configuration > Tasks** and select **Create a new WLAN**. The wizard opens and prompts you to enter the following information:

Configuration Setting	Description
<b>General</b>	
Name (SSID)	Name you assign to the new WLAN.
Primary Usage	Select whether the WLAN will be primarily supporting employees or guest users.
Broadcast on	Choose whether the WLAN SSID should broadcast on all APs associated to the managed device or Mobility Master configuration, or whether the WLAN should broadcast on APs in a selected AP group. If you choose the <b>Select AP Groups</b> option, you are prompted to select one or more AP groups.

Configuration Setting	Description
Forwarding Mode	If the forwarding mode is set to <b>Tunnel</b> , data is tunneled to the managed device using generic routing encapsulation (GRE). When a WLAN is configured to use the <b>Decrypt-Tunnel</b> forwarding mode, that AP decrypts and decapsulates all 802.11 frames from a client and sends the 802.3 frames through the GRE tunnel to the managed device, which then applies firewall policies to the user traffic. When the managed device sends traffic to a client, the managed device sends 802.3 traffic through the GRE tunnel to the AP, which then converts it to encrypted 802.11 and forwards to the client.
Broadcast SSID	By default, selected APs begin broadcasting the new WLAN SSID as soon as the new WLAN is created. If you do not want APs to broadcast the new WLAN, click the <b>Broadcast SSID</b> drop-down list and select <b>No</b> .
<b>VLANs</b>	
VLAN	The VLAN(s) into which users are placed in order to obtain an IP address. If you are creating a guest WLAN, remember that guest users must be separated from employee users by VLANs in the network.
Named VLANs	<p>Click the <b>Show VLAN Details</b> link to display the list of named VLANs configured on the managed device or Mobility Master.</p> <p>To add a new VLAN, click + below the <b>Named VLANs</b> table, then enter a VLAN name and a VLAN ID or range of IDs for the new VLAN. To edit a named VLAN, select the VLAN from the table and click the edit (pencil) icon.</p> <p>To create a range of multiple VLAN IDs, by specify the beginning and ending VLAN IDs separated by a hyphen. For example, 55-58.</p>
All VLAN IDs on This Controller	<p>Click the <b>Show VLAN Details</b> link to display the list of VLAN IDs configured on the managed device or Mobility Master.</p> <p>To add a VLAN ID, click + below the AI VLAN IDs table. To edit a VLAN ID, select the VLAN from the table and click the edit (pencil) icon. You can configure or edit the following settings:</p> <ul style="list-style-type: none"> <li>• <b>VLAN IDs:</b> Identification number for the VLAN</li> <li>• <b>Admin State:</b> Enable or disable the VLAN interface.</li> <li>• <b>IPv4 Address:</b> The IPv4 and netmask address for this interface</li> <li>• <b>Enable NAT:</b> Enables source network address translation (NAT) for all traffic routed from this VLAN. All ports on the managed device are assigned to VLAN 1 by default. Do not enable the NAT option for VLAN 1, as this will prevent IPsec connectivity between the managed device and its IPsec peers.</li> <li>• <b>Local Link Address:</b> Configures the specified IPv6 address as the link local address for this interface.</li> <li>• <b>Global Unicast Address:</b> Specify the IPv6 address prefix to configure the global unicast address for this interface. For example, 2001:DB8:0:3::/64</li> </ul>
<b>Security</b> <i>(for employee WLANs)</i>	
Enterprise	This option supports the following configuration parameters:

Configuration Setting	Description
	<ul style="list-style-type: none"> <li>● <b>Auth servers:</b> Click + to open the <b>Add Existing Server</b> window and select a preconfigured server from the list of servers. To define a new server, click + on the Add Existing Server window and define a new LDAP or RADIUS server. For details, see <a href="#">Configuring Authentication Servers on page 181</a></li> <li>● <b>Reauth Interval:</b> Interval, in seconds, between reauthentication attempts.</li> <li>● <b>Machine Authentication:</b> Select this option to enforce machine authentication before user authentication. If selected, either the machine-default-role or the user-default-role is assigned to the user, depending on which authentication is successful.</li> <li>● <b>Blacklisting:</b> Blacklists the client if authentication fails a specified number of times.</li> <li>● <b>Max Authentication Failures:</b> If <b>Blacklisting</b> is enabled, this parameter defines the number of times a user can try to login with wrong credentials after which the user is blacklisted as a security threat.</li> </ul>
Personal	<p>This option supports the following configuration parameters:</p> <ul style="list-style-type: none"> <li>● <b>Key management:</b> Use this setting to select the layer-2 encryption type to be used on this WLAN SSID. Select either <b>WPA-2 personal</b> (recommended) or <b>WPA personal</b>.</li> <li>● <b>Passphrase:</b> Enter the WPA-2 or WPA password</li> <li>● Retype: Retype the WPA-2 or WPA password</li> <li>● <b>MAC authentication:</b> Select this option to enforce machine authentication before user authentication. If selected, either the machine-default-role or the user-default-role is assigned to the user, depending on which authentication is successful.</li> <li>● <b>Blacklisting:</b> Blacklists the client if authentication fails a specified number of times.</li> <li>● <b>Max Authentication Failures:</b> If <b>Blacklisting</b> is enabled, this parameter defines the number of times a user can try to login with wrong credentials after which the user is blacklisted as a security threat.</li> </ul>
Open	<p>This option supports the following configuration parameters:</p> <ul style="list-style-type: none"> <li>● <b>MAC authentication:</b> Select this option to enforce machine authentication.</li> <li>● <b>Blacklisting:</b> Blacklists the client if authentication fails a specified number of times.</li> <li>● <b>Max Authentication Failures:</b> If <b>Blacklisting</b> is enabled, this parameter defines the number of times a user can try to login with wrong credentials after which the user is blacklisted as a security threat.</li> </ul>
<b>Security</b> (for guest WLANs)	
Clearpass or other external captive portal	<p>This option supports the following configuration parameters:</p> <ul style="list-style-type: none"> <li>● <b>Auth servers:</b> Click + to open the <b>Add Existing Server</b> window and select a preconfigured server from the list of servers. To define a new server, click + on the Add Existing Server window and define a new LDAP or RADIUS server. For details, see <a href="#">Configuring Authentication Servers on</a></li> </ul>

Configuration Setting	Description
	<p><a href="#">page 181</a></p> <ul style="list-style-type: none"> <li>● <b>CPPM Host:</b> IPv4 address of the ClearPass Policy Manager host.</li> <li>● <b>CPPM Page:</b> URL of the page that appears for the user logon. This can be set to any URL. Default: /auth/index.html</li> <li>● <b>Redirect URL:</b> URL to which an authenticated user will be directed. This parameter must be an absolute URL that begins with either http:// or https://.</li> </ul>
Internal captive portal with authentication	<p>This option supports the following configuration parameters:</p> <ul style="list-style-type: none"> <li>● <b>Template:</b> Define the title, text, banner icon and banner color for the captive portal landing page.</li> <li>● <b>Custom HTML:</b> Click this link to browse to and select HTML files for the initial login and welcome pages.</li> <li>● <b>Redirect URL:</b> URL to which an authenticated user will be directed. This parameter must be an absolute URL that begins with either http:// or https://.</li> </ul>
Internal captive portal with email registration	<p>This option supports the following configuration parameters:</p> <ul style="list-style-type: none"> <li>● <b>Template:</b> Define the title, text, banner icon and banner color for the captive portal landing page.</li> <li>● <b>Custom HTML:</b> Click this link to browse to and select HTML files for the initial login and welcome pages.</li> <li>● <b>Redirect URL:</b> URL to which an authenticated user will be directed. This parameter must be an absolute URL that begins with either http:// or https://.</li> </ul>
Internal captive portal, no auth or registration	<p>This option supports the following configuration parameters:</p> <ul style="list-style-type: none"> <li>● <b>Template:</b> Define the title, text, banner icon and banner color for the captive portal landing page.</li> <li>● <b>Custom HTML:</b> Click this link to browse to and select HTML files for the initial login and welcome pages.</li> <li>● <b>Redirect URL:</b> URL to which an authenticated user will be directed. This parameter must be an absolute URL that begins with either <b>http://</b> or <b>https://</b>.</li> </ul>
No Captive Portal	Guests are granted access without a captive portal.
<b>Access</b>	
Default Role	<p>Select a user role to be assigned to an employee that successfully authenticates to the WLAN.</p> <p>If you are creating an employee WLAN, click the <b>default role</b> drop-down list and select an existing user role, or define a new role for the WLAN, by selecting <b>Show Roles</b> and clicking + below the <b>Roles</b> table.</p>

Configuration Setting	Description
	<p>If you are creating a guest WLAN, the WLAN wizard automatically creates a default role for the guest users that have successfully authenticated to the WLAN, named is &lt;WLAN-name&gt;-guest-logon. To configure this role, click <b>Show Roles</b> and click + below the <b>Roles</b> table. As you configure your guest role, keep in mind the following guidelines for guest WLANs:</p> <ul style="list-style-type: none"> <li>• Guests must be limited not only in where they may go, but also by what network protocols and ports they may use to access resources.</li> <li>• Guests should be allowed to access only the local resources that are required for IP connectivity. These resources include DHCP and possibly DNS if an outside DNS server is not available. In most cases, a public DNS is always available.</li> <li>• All other internal resources should be off limits for the guest. This restriction is achieved usually by denying any internal address space to the guest user.</li> <li>• A time-of-day restriction policy should be used to allow guests to access the network only during normal working hours, because they should be using the network only while conducting official business. A rate limit can also be put on each guest user to keep the user from using up the limited wireless bandwidth. Accounts should be set to expire when their local work is completed, typically at the end of each business day.</li> </ul> <p><b>NOTE:</b> For complete information on creating user roles and assigning rules and policies to a role, see <a href="#">Roles and Policies on page 367</a>.</p>
Server Derived Roles	<p>(For employee WLANs using enterprise security) Enable this option to configure a server derivation rules that can assign a user role for the client can be based on one or more attributes returned by the server during authentication, or on client attributes such as SSID (even if the attribute is not returned by the server). Server-derivation rules are executed <i>after</i> client authentication.</p>
Derivation Method	<p>(For employee WLANs using enterprise security) Select a derivation method. Select <b>use value returned from ClearPass or other auth server</b> if your users will authenticate to the WLAN via ClearPass Policy Manager or another type of authentication server, or select <b>User rules defined in table below</b> to define a custom role based upon RADIUS Server VSAs. You will be prompted define the following values:</p> <ul style="list-style-type: none"> <li>• <b>Attribute:</b> RADIUS VSA type</li> <li>• <b>Condition:</b> contains, equals, not-equals, start-with or value-of</li> <li>• <b>String:</b> Text string compared against VSA condition</li> <li>• <b>Role:</b> Role assigned if the VSA condition and string match.</li> </ul> <p><b>NOTE:</b> For the current and complete list of all RADIUS VSAs available in the version of ArubaOS currently running on your managed device, access the command-line interface and issue the command <b>show aaa radius attributes</b>. See also <a href="#">RADIUS Server VSAs on page 185</a></p>

## Manually Creating a WLAN in the WebUI

The following workflow lists the tasks to manually configure a WLAN that uses 802.1X authentication. Click any of the links below for details on the configuration procedures for that task.





---

This method for configuring a WLAN is recommended for advanced users only.

---

1. [Configure your authentication servers.](#)
2. [Create an authentication server group](#), and assign the authentication servers you configured in step 1 to that server group.
3. [Configure a firewall access policy](#) for a group of users
4. [Create a user role](#), and assign the firewall access policy you created in step 3 to that user role.
5. [Configure the AAA profile for the configuration node.](#)
  - a. Assign the user role defined in step 4 to the AAA profile's **802.1X Authentication Default Role**
  - b. Associate the server group you created in step 2 to the AAA profile.
6. [Configure the SSID profile for the configuration node](#)
7. [Configure the virtual AP profile for the configuration node.](#) the Virtual AP profile for the configuration node will automatically be associated to the AAA profile configured in Step 5, and the SSID profile configured in Step 6.

## Manually Creating a WLAN in the CLI

The example below follows the suggested order of steps to configure a WLAN using the command-line interface.



---

This method for configuring a WLAN is recommended for advanced users only.

---

```
(host) [node] (config) #aaa server-group "THR-DOT1X-SERVER-GROUP-WPA2"
    auth-server Internal
!
ip access-list session THR-POLICY-NAME-WPA2
    user any any permit
!
(host) [node] (config) #user-role THR-ROLE-NAME-WPA2
    session-acl THR-POLICY-NAME-WPA2
!
(host) [node] (config) #aaa server-group "THR-DOT1X-SERVER-GROUP-WPA2"
    auth-server Internal
!
(host) [node] (config) #aaa profile "THR-AAA-PROFILE-WPA2"
    dot1x-default-role "THR-ROLE-NAME-WPA2"
    dot1x-server-group "THR-DOT1X-SERVER-GROUP-WPA2"
!
(host) [node] (config) #wlan ssid-profile "THR-SSID-PROFILE-WPA2"
    essid "THR-WPA2"
    opmode wpa2-aes
!
(host) [node] (config) #wlan virtual-ap "THR-VIRTUAL-AP-PROFILE-WPA2"
    ssid-profile "THR-SSID-PROFILE-WPA2"
    aaa-profile "THR-AAA-PROFILE-WPA2"
    vlan 60
!
(host) [node] (config) #ap-group "THRQ1-STANDARD"
    virtual-ap "THR-VIRTUAL-AP-PROFILE-WPA2"
```

## WLAN Configuration Profiles

You can configure your WLANs to provide different network access or services to users on the same physical network. For example, you can configure a WLAN to provide access to guest users and another WLAN to provide access to employee users through the same APs. You can also configure a WLAN that offers open authentication and Captive Portal access with data rates of 1 and 2 Mbps, and another WLAN that requires WPA authentication with data rates of up to 11 Mbps. You can apply both virtual AP configurations to the same AP or an AP group.

When you define a WLAN using the New WLAN wizard on the **Configuration > Tasks** page of the Mobility Master or stand-alone controller WebUI, the wizard automatically creates a new virtual AP profile, AAA profile, 802.11X, Server group profile and SSID profile with the same name as the WLAN, and with the configuration settings and values defined via the wizard. These profiles also support additional advanced features that are not configurable via the WLAN wizard on the **Configuration > Tasks** page.

The following table describes the profiles that comprise the configuration settings for an ArubaOS WLAN, with links to the sections of this document that describe these profiles in more detail.

**Table 76:** WLAN Profiles

Profile	Description
<a href="#">Virtual AP Profile</a>	<p>This is the top-level WLAN configuration profile. A Virtual AP profile allows you to configure WLAN settings such as broadcast/multicast settings, forwarding modes and RF bands, but it also identifies the individual 802.11k, AAA, Anyspot, Hotspot 2.0, SSID and WWM Traffic management profiles to be used by that WLAN.</p> <p>Default profile name: &lt;WLAN Name&gt;</p> <p>When you create a WLAN using the WLAN wizard, ArubaOS automatically creates a new Virtual AP profile with the same name as the WLAN.</p>
<a href="#">802.11k profile</a>	<p>The 802.11k protocol provides mechanisms for APs and clients to dynamically measure the available radio resources. Each 802.11k profile also references one instance of each the following additional profile types.</p> <ul style="list-style-type: none"> <li>• <a href="#">Beacon Report Request profile</a>: Defines beacon report request settings. Beacon report requests are sent only to 802.11k-compliant clients that advertise Beacon Report Capability in their RRM Enabled Capabilities IE.</li> <li>• <a href="#">RRM IE profile</a>: Defines Radio Resource Management Information Elements (RRM IEs) for WLANs with 802.11k support enabled.</li> <li>• <a href="#">TSM Report Request profile</a>: Defines Traffic Stream Measurement (TSM) Report Requests. These report requests are sent only to 802.11k-compliant clients that advertise a traffic stream report capability.</li> </ul> <p>Default profile name: default</p>
<a href="#">AAA profile</a>	<p>The AAA profile defines the type of authentication used by clients associating to a WLAN. Each AAA profile also references one instance of each the following additional profile types:</p> <ul style="list-style-type: none"> <li>• <a href="#">802.1X Authentication profile</a>: Defines 802.1X authentication settings.</li> <li>• <a href="#">802.1X Authentication Server Group profile</a>: Defines fail through and load balancing settings for a group of servers used for 802.1X authentication.</li> <li>• <a href="#">MAC Authentication profile</a>: Defines MAC authentication settings.</li> <li>• <a href="#">MAC Authentication Server Group profile</a>: Defines fail through and load balancing settings for a group of servers used for MAC authentication.</li> <li>• <a href="#">RADIUS Accounting Server Group profile</a>: Defines fail through and load balancing settings for</li> </ul>

Profile	Description
	<p>a group of servers used for RADIUS accounting.</p> <ul style="list-style-type: none"> <li>• <a href="#">RFC 3576 Server profile</a>: Defines a RADIUS server to send user disconnect, change-of-authorization (CoA), and session timeout messages as described in RFC 3576.</li> <li>• <a href="#">XML API Server profile</a>: Define an authentication key for an XML API server, to perform customized external captive portal user management using an XML API interface.</li> </ul> <p>Default profile name: &lt;WLAN Name&gt;</p> <p>When you create a WLAN using the WLAN wizard, ArubaOS automatically creates a new AAA profile with the same name as the WLAN.</p>
<a href="#">AnySpot Profile</a>	<p>The anyspot client probe suppression feature decreases network traffic by suppressing probe requests from clients attempting to locate and connect to other known networks. By default, a virtual AP is not associated with an Anyspot profile, so an Anyspot profile must first be defined, and then manually associated to the virtual AP.</p> <p>Default profile name: N/A</p>
<a href="#">Hotspot 2.0 Profile</a>	<p>Hotspot 2.0 is a Wi-Fi Alliance Passpoint specification based upon the 802.11u protocol that provides wireless clients with a streamlined mechanism to discover and authenticate to suitable networks, and allows mobile users the ability to roam between partner networks without additional authentication. The Hotspot profile for a WLAN references a hotspot <i>advertisement</i> profile, which in turn references several other profiles that define settings for individual hotspot features.</p> <ul style="list-style-type: none"> <li>• <a href="#">Hotspot Advertisement Profiles</a></li> <li>• <a href="#">ANQP Venue Name Profiles</a></li> <li>• <a href="#">ANQP Network Authentication Profiles</a></li> <li>• <a href="#">ANQP Domain Name Profile</a></li> <li>• <a href="#">ANQP IP Address Availability Profiles</a></li> <li>• <a href="#">ANQP NAI Realm Profiles</a></li> <li>• <a href="#">ANQP Roaming Consortium Profiles</a></li> <li>• <a href="#">ANQP 3GPP Cellular Network Profiles</a></li> <li>• <a href="#">H2QP Connection Capability Profiles</a></li> <li>• <a href="#">H2QP Operator Friendly Name Profiles</a></li> <li>• <a href="#">H2QP Operating Class Indication Profiles</a></li> <li>• <a href="#">H2QP WAN Metrics Profiles</a></li> </ul> <p>Default profile name: &lt;WLAN Name&gt;</p> <p>When you create a WLAN using the WLAN wizard, ArubaOS automatically creates a new Hotspot 2.0 profile with the same name as the WLAN.</p>
<a href="#">SSID Profile</a>	<p>A SSID profile defines the name of the network, authentication type for the network, basic rates, transmit rates, SSID cloaking, and certain WMM settings for the network. Each SSID profile also references one instance of each the following additional profile types:</p> <ul style="list-style-type: none"> <li>• <a href="#">80.11r profile</a>: The Fast BSS Transition (802.11r) mechanism minimizes the delay when a voice client transitions from one BSS to another within the same ESS.</li> <li>• <a href="#">EDCA Parameters (AP) profile</a>: ArubaOS supports media access prioritization through Enhanced Distributed Channel Access (EDCA), which defines four access categories (ACs) to</li> </ul>

Profile	Description
	<p>prioritize traffic. This profile defines EDCA settings for APs.</p> <ul style="list-style-type: none"> <li>• <a href="#">EDCA Parameters (Station) profile</a>: ArubaOS supports media access prioritization through Enhanced Distributed Channel Access (EDCA), which defines four access categories (ACs) to prioritize traffic. This profile defines EDCA settings for clients.</li> <li>• <a href="#">High-throughput SSID profile</a>: Defines 802.11ac very-high-throughput settings for the 5 GHz frequency band, and high-throughput (802.11n) settings for both the 5 GHz and 2.4 GHz frequency bands.</li> </ul> <p>Default profile name: &lt;WLAN Name&gt;</p> <p>When you create a WLAN using the WLAN wizard, ArubaOS automatically creates a new SSID profile with the same name as the WLAN.</p>

## Modifying Profile Parameters Associated with WLANs

Starting from ArubaOS 8.0.1 you can modify the parameters of profiles that are associated to a WLAN when it was created.




---

The Virtual AP profile parameters cannot be modified.

---

### In the WebUI

1. In the **Mobility Master** node hierarchy, navigate to the **Configuration > WLANs** tab.
2. Select a WLAN in the **WLANs** table and click **Profiles** tab.
3. Click **Wireless LAN > Virtual AP > WLAN NAME** under **Profiles for WLAN <Profile Name>**.
4. Make the necessary changes to the profile and click **Submit**.
5. Click **Pending Changes**.
6. In the **Pending Changes** window, select the check box and click **Deploy changes**.

## Configuring the Virtual AP Profile

The recommended method for creating a new WLAN configuration is through the new WLAN wizard, although advanced users may also configure a WLAN manually via the ArubaOS WebUI and command-line interfaces.

Follow the procedure below to manually configure a Virtual AP profile using the WebUI or command-line interfaces.




---

For important information on changing the virtual AP forwarding mode for a WLAN serving active wired or wireless clients, see [Changing a Virtual AP Forwarding Mode on page 419](#).

---

### In the WebUI

1. In the **Managed Network** node hierarchy, navigate to **Configuration > System > Profiles**.
2. In the **All Profiles** list, expand the **Wireless LAN** menu, then select **Virtual AP**.
3. Select the virtual AP profile you want to edit, or click + to create a new profile.  
The Virtual AP profile settings are divided into four sections, **Broadcast/Multicast**, **General**, **RF** and **Advanced**. The profile parameters in each section are described in [Table 77](#).
4. Click **Save**.
5. Click **Pending Changes**.
6. In the **Pending Changes** window, select the check box and click **Deploy Changes**.

**Table 77: Virtual AP Profile Parameters**

Parameter	Description
<b>BroadCast/Multicast</b>	
Dynamic Multicast Optimization (DMO)	Enable/Disable dynamic multicast optimization. This parameter is disabled by default, and cannot be enabled without the PEFNG license.
Dynamic Multicast Optimization (DMO) Threshold	Maximum number of high-throughput stations in a multicast group beyond which dynamic multicast optimization stops. Range: 2-255 stations Default: 6 stations.
Drop Broadcast and Multicast	Select the <b>Drop Broadcast and Multicast</b> check box to filter out broadcast and multicast traffic in the air.  Do not enable this option for virtual APs configured in bridge forwarding mode. This configuration parameter is only intended for use for virtual APs in tunnel mode. In tunnel mode, all packets travel to the controller, so the controller is able to drop all broadcast traffic. When a virtual AP is configured to use bridge forwarding mode, most data traffic stays local to the AP, and the controller is not able to filter out that broadcast traffic.  <b>IMPORTANT:</b> If you enable this option, you must also enable the <b>Convert Broadcast ARP requests to unicast</b> parameter on the virtual AP profile to prevent ARP requests from being dropped.
Convert Broadcast ARP requests to unicast	If enabled, all broadcast ARP requests are converted to unicast and sent directly to the client. You can check the status of this option using the <b>show ap active</b> and the <b>show datapath tunnel</b> command. If enabled, the output will display the letter <b>a</b> in the flags column.  This configuration parameter is only intended for use for virtual APs in tunnel mode. In tunnel mode, all packets travel to the controller, so the controller is able to convert ARP requests directed to the broadcast address into unicast.  When a virtual AP is configured to use bridge forwarding mode, most data traffic stays local to the AP, and the controller is not able to convert that broadcast traffic.  This parameter is enabled by default. Behaviors associated with these settings are enabled upon upgrade to ArubaOS 6.1.3.2. If your controller supports clients behind a wireless bridge or virtual clients on VMware devices, you must disable this setting to allow those clients to obtain an IP address. In previous releases of ArubaOS, the virtual AP profile included two unique broadcast filter parameters; the <b>drop broadcast and multicast</b> parameter, which filtered out all broadcast and multicast traffic in the air except DHCP response frames (these were converted to unicast frames and sent to the corresponding client) and the <b>convert Broadcast ARP requests to unicast</b> parameter, which converted broadcast ARP requests to unicast messages sent directly to the client.  The <b>Convert Broadcast ARP requests to unicast</b> setting includes the additional functionality of broadcast-filter all parameter, where DHCP response frames are sent as unicast to the corresponding client. This can impact DHCP discover/requested packets for clients behind a wireless bridge and virtual clients on VMware devices. Disable this option to resolve this issue and allow clients behind a wireless bridge or VMware devices to receive an IP address.  Default: Enabled

Parameter	Description
<b>General</b>	
Virtual AP enable	Select the <b>Virtual AP enable</b> check box to enable or disable the virtual AP.
VLAN	<p>The VLAN(s) into which users are placed in order to obtain an IP address. Click the drop-down list to select a configured VLAN, the click the arrow button to associate that VLAN with the virtual AP profile.</p> <p><b>NOTE:</b> You must add an existing VLAN ID to the Virtual AP profile.</p>
Forward mode	<p>This parameter controls whether data is tunneled to the controller using generic routing encapsulation (GRE), bridged into the local Ethernet LAN (for remote APs), or a combination thereof depending on the destination (corporate traffic goes to the controller, and Internet access remains local). All forwarding modes support band steering, TSPEC/TCLAS enforcement, 802.11k and station blacklisting.</p> <p>Click the drop-down list to select one of the following forward modes:</p> <ul style="list-style-type: none"> <li> <p><b>Tunnel:</b> The AP handles all 802.11 association requests and responses, but sends all 802.11 data packets, action frames and EAPOL frames over a GRE tunnel to the controller for processing. The controller removes or adds the GRE headers, decrypts or encrypts 802.11 frames and applies firewall rules to the user traffic as usual. Both remote and campus APs can be configured in tunnel mode.</p> </li> <li> <p><b>Bridge:</b> 802.11 frames are bridged into the local Ethernet LAN. When a remote AP or campus AP is in bridge mode, the AP (and not the controller) handles all 802.11 association requests and responses, encryption/decryption processes, and firewall enforcement. The 802.11e and 802.11k action frames are also processed by the AP, which then sends out responses as needed.</p> <p>An AP in bridge mode does not support captive portal authentication. Both remote and campus APs can be configured in bridge mode. Note that you must enable the control plane security feature on the controller before you configure campus APs in bridge mode.</p> </li> <li> <p><b>Split-Tunnel:</b> 802.11 frames are either tunneled or bridged, depending on the destination (corporate traffic goes to the controller, and Internet access remains local).</p> <p>A remote AP in split-tunnel forwarding mode handles all 802.11 association requests and responses, encryption/decryption, and firewall enforcement. The 802.11e and 802.11k action frames are also processed by the remote AP, which then sends out responses as needed.</p> </li> <li> <p><b>Decrypt-Tunnel:</b> Both remote and campus APs can be configured in decrypt-tunnel mode. When an AP uses decrypt-tunnel forwarding mode, that AP decrypts and decapsulates all 802.11 frames from a client and sends the 802.3 frames through the GRE tunnel to the controller, which then applies firewall policies to the user traffic.</p> <p>When the controller sends traffic to a client, the controller sends 802.3 traffic through the GRE tunnel to the AP, which then converts it to encrypted 802.11 and forwards to the client. This forwarding mode allows a network to utilize the encryption/decryption capacity of the AP while reducing the demand for processing resources on the controller.</p> <p>APs in decrypt-tunnel forwarding mode also manage all 802.11 association requests and responses, and process all 802.11e and 802.11k action frames. APs using decrypt-tunnel mode do have some limitations that not present for APs in regular tunnel forwarding mode.</p> <p>You must enable the control plane security feature on the controller before you configure campus APs in decrypt-tunnel forward mode.</p> </li> </ul>

Parameter	Description
	<p><b>NOTE:</b> Virtual APs in bridge or split-tunnel mode using static WEP should use key slots 2-4 on the controller. Key slot 1 should only be used with Virtual APs in tunnel mode.</p>
<b>RF</b>	
Allowed band	<p>The band(s) on which to use the virtual AP:</p> <ul style="list-style-type: none"> <li>• <b>a</b>—802.11a band only (5 GHz).</li> <li>• <b>g</b>—802.11b/g band only (2.4 GHz).</li> <li>• <b>all</b>—both 802.11a and 802.11b/g bands (5 GHz and 2.4 GHz). This is the default setting.</li> </ul>
Band Steering	<p>ARM's band steering feature encourages dual-band capable clients to stay on the 5GHz band on dual-band APs. This frees up resources on the 2.4GHz band for single band clients like VoIP phones.</p> <p>Band steering reduces co-channel interference and increases available bandwidth for dual-band clients, because there are more channels on the 5GHz band than on the 2.4GHz band. Dual-band 802.11n-capable clients may see even greater bandwidth improvements, because the band steering feature will automatically select between 40MHz or 20MHz channels in 802.11n networks. This feature is disabled by default, and must be enabled in a Virtual AP profile.</p> <p>The band steering feature supports both campus APs and remote APs that have a virtual AP profile set to <b>tunnel</b>, <b>split-tunnel</b> or <b>bridge</b> forwarding mode. Note, however, that if a campus or remote APs has virtual AP profiles configured in bridge or split-tunnel forwarding mode but no virtual AP in tunnel mode, those APs will gather information about 5G-capable clients independently and will not exchange this information with other APs that also have bridge or split-tunnel virtual APs only.</p>
Steering Mode	<p>Band steering supports the following three different band steering modes.</p> <ul style="list-style-type: none"> <li>• <b>Force-5GHz:</b> When the AP is configured in <b>force-5GHz</b> band steering mode, the AP will try to force 5Ghz-capable APs to use that radio band.</li> <li>• <b>Prefer-5GHz (Default):</b> If you configure the AP to use <b>prefer-5GHz</b> band steering mode, the AP will try to steer the client to 5G band (if the client is 5G capable) but will let the client connect on the 2.4G band if the client persists in 2.4 G association attempts.</li> <li>• <b>Balance-bands:</b> In this band steering mode, the AP tries to balance the clients across the two radios in order to best utilize the available 2.4G bandwidth. This feature takes into account the fact that the 5Ghz band has more channels than the 2.4 Ghz band, and that the 5 Ghz channels operate in 40MHz while the 2.5 Ghz band operates in 20 MHz.</li> </ul>
<b>Advanced</b>	
Cellular Handoff Assist	<p>When both the client match and the cellular handoff assist features are enabled, the cellular handoff assist feature can help a dual-mode, 3G/4G-capable Wi-Fi device such as an iPhone, iPad or Android client at the end of a Wi-Fi network switch from Wi-Fi to an alternate 3G/4G radio that provides better network access. This feature is supported by iOS and Android devices only.</p>

Parameter	Description
Authentication Failure Blacklist Time	Time, in seconds, a client is blocked if it fails repeated authentication. The default setting is 3600 seconds (1 hour). A value of 0 blocks the client indefinitely.
Blacklist Time	Number of seconds that a client is quarantined from the network after being blacklisted. Default: 3600 seconds (1 hour)
Deny inter user traffic	<p>Select this check box to deny traffic between the clients using this virtual AP profile.</p> <p>The global firewall shown the <b>Configuration&gt;Advanced Services &gt; Stateful Firewall &gt; Global</b> window also includes an option to deny all inter-user traffic, regardless of the Virtual AP profile used by those clients.</p> <p>If the global setting to deny inter-user traffic is enabled, all inter-user traffic between clients will be denied, regardless of the settings configured in the virtual AP profiles. If the setting to deny inter-user traffic is disabled globally but enabled on an individual virtual ap, only the traffic between un-trusted users and the clients on that particular virtual AP will be blocked.</p>
Deny time range	Click the drop-down list and select a configured time range for which the AP will deny access. If you have not yet configured a time range, navigate to <b>Configuration &gt; Security &gt; Access Control &gt; Time Ranges</b> to define a time range before configuring this setting in the Virtual AP profile.
DoS Prevention	If enabled, APs ignore deauthentication frames from clients. This prevents a successful deauthorization attack from being carried out against the AP. This does not affect third-party APs. Default: Disabled
HA Discovery on-association	<p>If enabled, home agent discovery is triggered on client association instead of home agent discovery based on traffic from client. Mobility on association can speed up roaming and improve connectivity for clients that do not send many uplink packets to trigger mobility (VoIP clients). Best practices is to disable this parameter as it increases IP mobility control traffic between managed devices in the same mobility domain. Enable this parameter only when voice issues are observed in VoIP clients.</p> <p>Default: Disabled</p> <p><b>NOTE:</b> <b>ha-disc-onassoc</b> parameter works only when IP mobility is enabled and configured on the managed device. For more information about this parameter, see <a href="#">HA Discovery on Association on page 608</a></p>
Mobile IP	<p>Enables or disables IP mobility for this virtual AP.</p> <p>Default: Enabled</p>
Preserve Client VLAN	If you select this check box, clients retain their previous VLAN assignment if the client disassociates from an AP and then immediately re-associates either with same AP or another AP on the same managed device.
Remote-AP Operation	<p>Configures when the virtual AP operates on a remote AP:</p> <ul style="list-style-type: none"> <li>• <b>always</b>—Permanently enables the virtual AP (Bridge Mode only). This option can be used for non-802.1X bridge VAPs.</li> <li>• <b>backup</b>—Enables the virtual AP if the remote AP cannot connect to the managed device (Bridge Mode only). This option can be used for non-802.1X bridge VAPs.</li> </ul>



Parameter	Description
	<ul style="list-style-type: none"> <li>● <b>persistent</b>—Permanently enables the virtual AP after the remote AP initially <b>connects</b> to the managed device (Bridge Mode only). This option can be used for any (Open/PSK/802.1X) bridge VAPs.</li> <li>● <b>standard</b>—Enables the virtual AP when the remote AP connects to the managed device. This option can be used for any (bridge/split-tunnel/tunnel/d-tunnel) VAPs.</li> </ul>
Station Blacklisting	<p>Select the <b>Station Blacklisting</b> check box to enable detection of denial of service (DoS) attacks, such as ping or SYN floods, that are not spoofed deauthorization attacks.</p> <p>Default: Enabled</p>
Strict Compliance	<p>If enabled, the AP denies client association requests if the AP and client station have no common rates defined. Some legacy client stations which are not fully 802.11-compliant may not include their configured rates in their association requests. Such non-compliant stations may have difficulty associating with APs unless strict compliance is disabled. This parameter is disabled by default.</p>
VLAN Mobility	<p>Enable or disable VLAN (Layer-2) mobility.</p> <p>Default: Disabled</p>
WAN operation mode	<p>This feature works in conjunction with the WAN Health Check Manager and Uplink Manager. When all uplinks are be down, the uplink manager makes the needed changes based on configuration and pushes these changes to APs.</p> <ul style="list-style-type: none"> <li>● If the operation mode is set to <b>primary</b>, the VAP will be disabled.</li> <li>● If the operation mode is set to <b>backup</b>, the VAP will be enabled.</li> <li>● If the operation mode is set to <b>Always</b>, the VAP will not change.</li> </ul>
FDB Update on Assoc	<p>This parameter enables seamless failover for silent clients, allowing them to re-associate. If you select this option, the controller will generate a Layer 2 update on behalf of client to update forwarding tables in bridge devices.</p> <p>Default: Disabled</p>

A Virtual AP profile directly references one of each of the following profiles types.

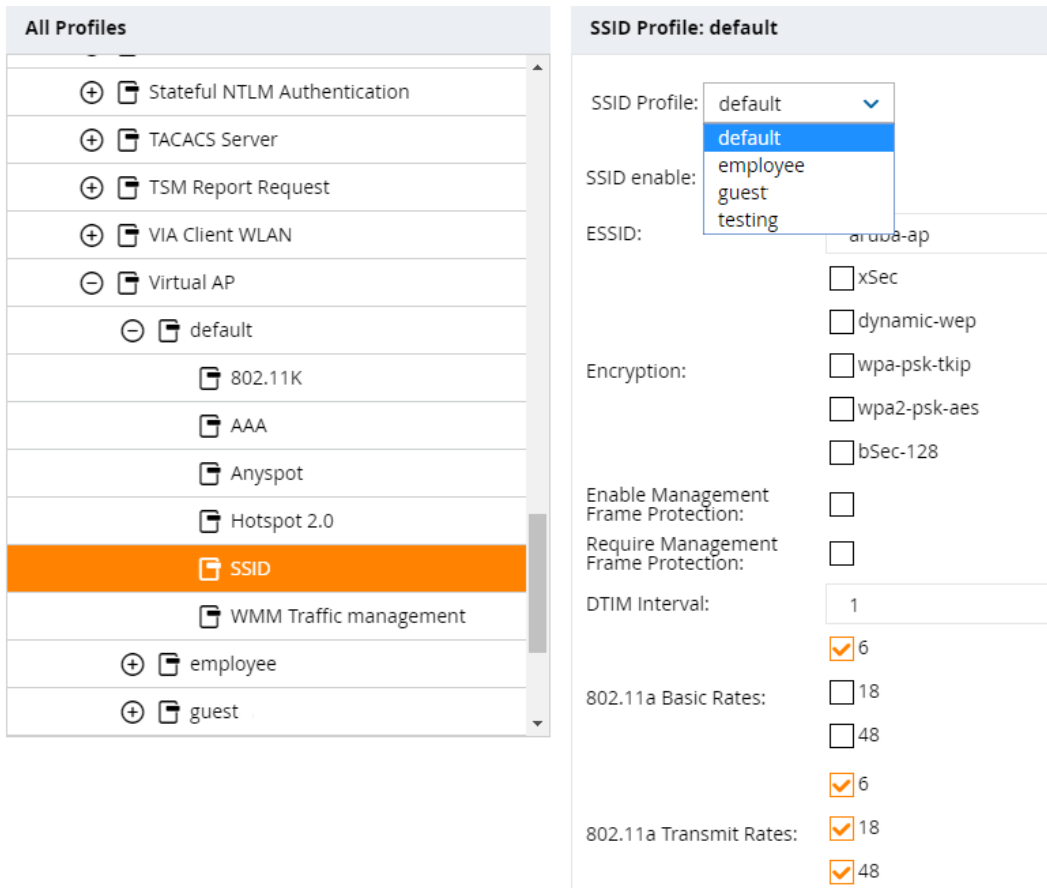
- 802.11k
- AAA
- AnySpot
- HotSpot 2.0
- SSID
- WWM Traffic Management

To change the profiles associated to a Virtual AP profile:

1. In the **Managed Network** node hierarchy, navigate to **Configuration > System > Profiles**.
2. In the **All Profiles** list, expand the **Wireless LAN** menu, then select **Virtual AP**.
3. Select the Virtual AP profile you want to edit. The **All Profiles** window displays the list of associated profiles for that Virtual AP.
4. Select any of the associated profiles in the list.

5. A drop-down list appears at the top of the right window pane which allows you to select another profile of that type.
6. Click **Save**.
7. Click **Pending Changes**.
8. In the **Pending Changes** window, select the check box and click **Deploy Changes**.

**Figure 33** Associating Profiles to a Virtual AP



### In the CLI

```
(host) [node] (config) #wlan virtual-ap <profile>
(host) [node] (Virtual AP profile "profile")aaa-profile <profile>
(host) [node] (Virtual AP profile "profile")anyspot-profile <profile>
(host) [node] (Virtual AP profile "profile")dot11k-profile <profile>
(host) [node] (Virtual AP profile "profile")hs2-profile <profile>
(host) [node] (Virtual AP profile "profile")ssid-profile <profile>
(host) [node] (Virtual AP profile "profile")wmm-traffic-management-profile <profile>
```

## Modifying Profiles and Parameters Associated with AP Groups

Starting from ArubaOS 8.0.1 you can modify the profiles and parameters associated with an AP group.

### In the WebUI

1. In the **Mobility Master** node hierarchy, navigate to the **Configuration > AP Groups** tab.
2. Select a AP group in the **AP Groups** table and click **Profiles** tab.
3. Select a profile under **Profiles for Group <AP Group>**.
4. Click **<NAME> profile** drop-down list and select a profile.

5. Make the necessary changes to the profile and click **Submit**.
6. Click **Pending Changes**.
7. In the **Pending Changes** window, select the check box and click **Deploy changes**.

## Selective Multicast Streams

The selective multicast group is based only on the packets learned through the Internet Group Management Protocol (IGMP).

- When the **Drop Broadcast and Multicast** setting is enabled in the virtual AP profile, the managed device allows multicast packets to be forwarded only if the following conditions are met:
  - packets originating from the wired side have a destination address range of 225.0.0.0 - 239.255.255.255
  - a station has subscribed to a multicast group.
- If the **Dynamic Multicast Optimization (DMO)** setting is enabled in the virtual AP profile, the packets are sent with 802.11 unicast header.
- When [IGMP snooping/proxy](#) is disabled, the managed device is not aware of the IGMP membership and drops the multicast flow.
- If [AirGroup](#) is enabled, mDNS (SSDP) packets are sent to the AirGroup application. The common address for mDNS is 224.0.0.251 and SSDP is 239.255.255.250.

## Changing a Virtual AP Forwarding Mode

When you change the forwarding mode for a Virtual AP actively serving clients, the user table will NOT reflect accurate client information unless the entries for those users are manually cleared. Use the following procedure to change the forwarding mode on a Virtual AP serving wired or wireless clients.

### Changing the Forwarding Mode for Wired Users

To change the forwarding mode for wired users connected to the wired port on an AP:

1. Disable the port by issuing the CLI command **ap wired-port-profile <ap-wired-port-profile> shutdown**. This will disconnect any wired clients using that port.
2. Issue the command **aaa user delete {<ipaddr> |all| mac <macaddr> | name <username> | role <role>}** to remove from the user table the wired users associated with AP wired ports using the <ap-wired-port-profile>.
3. Issue the command **ap wired-ap-profile <profile> forward-mode <mode>** where <mode> is the new forwarding mode for the wired port
4. Reenable the port using the command **ap wired-port-profile <ap-wired-port-profile> no shutdown**.

### Changing the Forwarding Mode for Wireless Users

To change the forwarding mode for wireless users associated with an AP radio:

1. Issue the command **ap-name <group> no virtual-ap <vap-profile>** or **ap-group <group> no virtual-ap <vap-profile>** to disassociate the AP or group of APs from the virtual AP profile.
2. Issue the command **aaa user delete {<ipaddr> |all| mac <macaddr> | name <username> | role <role>}** to remove from the user table the users associated to the virtual-ap specified in the previous step.
3. Issue the command **wlan virtual-AP <vap-profile> forward-mode <mode>** where <mode> is the new forwarding mode for the virtual AP.
4. Issue the command **ap-name <group> virtual-ap <vap-profile>** or **ap-group <group> virtual-ap <vap-profile>** to reassociate the AP or group of APs with the virtual AP profile.

## Radio Resource (802.11k) and BSS Transition Management (802.11v)

The 802.11k protocol provides mechanisms for APs and clients to dynamically measure the available radio resources. In an 802.11k enabled network, APs and clients can send neighbor reports, beacon reports, and link measurement reports to each other. This allows the APs and clients to take appropriate connection actions.

The 802.11v BSS Transition capability can improve throughput, data rates and QoS for the voice clients in a network by shifting (via transition) the individual voice traffic loads to more appropriate points of association within the ESS.

This topic includes the following procedures:

- [Configuring the 802.11k Profile on page 420](#)
- [Configuring Radio Resource Management Information Elements on page 422](#)
- [Configuring Beacon Report Requests on page 424](#)
- [Configuring Traffic Stream Measurement Report Requests on page 426](#)
- [BSS Transition Management \(802.11v\) on page 427](#)

### Configuring the 802.11k Profile

The following procedures outline the steps to configure 802.11k parameters for a configuration node.

#### In the WebUI

1. In the **Managed Network** node hierarchy, navigate to the **Configuration > System > Profiles** window.
2. In the Profiles list, expand the **Wireless LAN** menu, then select **802.11k**
3. To edit an existing 802.11k profile, select the 802.1X profile you want to edit. To create a new 802.11k profile, click + and enter a name for the new 802.11k profile name in the **profile name** field.
4. Configure your 802.11k radio settings. [Table 78](#) outlines the parameters you can configure in the 802.11k profile.
5. Click **Save**.
6. Click **Pending Changes**.
7. In the **Pending Changes** window, select the check box and click **Deploy Changes**.

**Table 78: 802.11k Profile Parameters**

Parameter	Description
Advertise 802.11k Capability	<p>Select this option to allow Virtual APs using this profile to advertise 802.11k capability. Enabling this option also enables support for the 802.11v BSS transition management feature described in <a href="#">BSS Transition Management (802.11v) on page 427</a>.</p> <p>Default: Disabled</p>
Forcefully disassociate on-hook voice clients	<p>Select this option to allow the AP to forcefully disassociate <i>on-hook</i> voice clients (clients that are not on a call) after period of inactivity. Without the forced disassociation feature, if an AP has reached its call admission control limits and an on-hook voice client wants to start a new call, that client may be denied. If forced disassociation is enabled, those clients can associate to a neighboring AP that can fulfill their QoS requirements.</p> <p>Default: Disabled</p>
Measurement Mode for Beacon Reports	<p>Click the <b>Measurement Mode for Beacon Reports</b> drop-down list and specify one of the following measurement modes:</p> <ul style="list-style-type: none"> <li>• <b>active-all-ch</b>—Enables active beacon measurement mode. In this mode, the client sends a probe request to the broadcast destination address on all supported channels, sets a measurement duration timer, and, at the end of the measurement duration, compiles all received beacons or probe response with the requested SSID and BSSID into a measurement report.</li> <li>• <b>active-ch-rpt</b>—In this mode, the client and returns a report that contains a list of channels in a regulatory class where a client is likely to find an AP, including the AP transmitting the AP channel report.</li> <li>• <b>beacon-table</b>—Enables beacon-table beacon measurement mode. In this mode, the client measures beacons and returns a report with stored beacon information for any supported channel with the requested SSID and BSSID. The client does not perform any additional measurements.</li> <li>• <b>passive</b>—Enables passive beacon measurement mode. In this mode, the client sets a measurement duration timer, and, at the end of the measurement duration, compiles all received beacons or probe response with the requested SSID and BSSID into a measurement report.</li> </ul> <p><b>NOTE:</b> If a station doesn't support the selected measurement mode, it returns a Beacon Measurement Report with the Incapable bit set in the Measurement Report Mode field.</p> <p>Default Mode: beacon-table</p>
Channel for Beacon Requests in 'A' band	<p>This value is sent in the 'Channel' field of the beacon requests on the 'A' radio. You can specify values in the range 34 to 165. The default value is 36.</p>
Channel for Beacon Requests in 'BG' band	<p>This value is sent in the 'Channel' field of the Beacon Requests on the 'BG' radio. You can specify values in the range 1 to 14. The default value is 1.</p>

Parameter	Description
Channel for AP Channel Reports in 'A' band	This value is sent in the 'Channel' field of the AP channel reports on the 'A' radio. You can specify values in the range 34 to 165. The default value is 36.
Channel for AP Channel Reports in 'BG' band	This value is sent in the 'Channel' field of the AP channel reports on the 'BG' radio. You can specify values in the range 1 to 14. The default value is 1.
Time duration between consecutive Beacon Requests	This option configures the time duration between two consecutive beacon requests sent to a dot11K client. By default, the beacon requests are sent to a dot11K client every 60 seconds. However, if a different value is required, the <code>bcn-req-time</code> option can be used.  This permits values in the range from 10 seconds to 200 seconds. A value of 0 is used to indicate that the generation of Beacon Request frames is turned off.
Time duration between consecutive Link Measurement Requests	This option configures the time duration between two consecutive link measurement requests sent to an dot11K client. By default, link measurement requests are sent to a dot11K client every 61 seconds.  This parameter permits values in the range from 10 seconds to 200 seconds. A value of 0 is used to indicate that the generation of Link Measurement Request frames is turned off.
Time duration between consecutive Transmit Stream Measurement Request	This option configures the time duration between two consecutive transmit stream measurement requests sent to a dot11K client. By default, the transmit stream measurement requests are sent to a dot11K client every 90 seconds.  This permits values in the range from 10 seconds to 200 seconds. A value of 0 is used to indicate that the generation of Transmit Stream Measurement Request frames is turned off.

### In the CLI

Use the following command to configure 802.11k profiles. The available parameters for this profile are described in [Table 78](#).

```
(host) [node] (config) #wlan dot11k-profile <profile-name>
```

## Configuring Radio Resource Management Information Elements

ArubaOS supports the following radio resource management information elements (RRM IEs) for APs with 802.11k support enabled. These settings can be enabled through the WebUI or CLI.

### In the WebUI

To select the RRM IEs to be sent in beacons and probe responses using the WebUI:

1. Navigate to **Configuration>System>Profiles**.
2. Expand the **Wireless LAN** menu and select **RRM IE**.
3. Select the RRM IE profile you want to configure, or create a new profile by clicking + and entering a name for the new profile in the **Profile Name** field.
4. Select any of the following IE types to enable that information element in beacons and probe responses. (All IE types are sent by default.)

**Table 79: RRM IE Parameters**

Parameter	Description
Advertise Enabled Capabilities IE	This value is used to determine if the RRM Enabled Capabilities IE should be advertised in the beacon frames. A value of "Enabled" allows the RRM Enabled Capabilities IE to be present in the beacon frames when 802.11K capability is enabled. A value of "Disabled" prevents the advertisement of the RRM Enabled Capabilities IE in the beacon frames when 802.11K capability is enabled.
Advertise Country IE	This value is used to determine if the Country IE should be advertised in the beacon frames. A value of "Enabled" allows the Country IE to be present in the beacon frames when 802.11K capability is enabled. A value of "Disabled" prevents the advertisement of the Country IE in the beacon frames when 802.11K capability is enabled.
Advertise Power Constraint IE	This value is used to determine if the Power Constraint IE should be advertised in the beacon frames. A value of "Enabled" allows the Power Constraint IE to be present in the beacon frames when 802.11K capability is enabled. A value of "Disabled" prevents the advertisement of the Power Constraint IE in the beacon frames when 802.11K capability is enabled.
Advertise TPC Report IE	This value is used to determine if the TPC Report IE should be advertised in the beacon frames. A value of "Enabled" allows the TPC Report IE to be present in the beacon frames when 802.11K capability is enabled. A value of "Disabled" prevents the advertisement of the TPC Report IE in the beacon frames when 802.11K capability is enabled.
Advertise QBSS Load IE	This value is used to determine if the QBSS Load IE should be advertised in the beacon frames. A value of "Enabled" allows the QBSS Load IE to be present in the beacon frames when 802.11K capability is enabled. A value of "Disabled" prevents the advertisement of the QBSS Load IE in the beacon frames when 802.11K capability is enabled. The default value is "Enabled".
Advertise BSS AAC IE	This value is used to determine if the BSS Available Admission Capacity IE should be advertised in the beacon frames. A value of "Enabled" allows the BSS Available Admission Capacity IE to be present in the beacon frames when 802.11K capability is enabled. A value of "Disabled" prevents the advertisement of the BSS Available Admission Capacity IE in the beacon frames when 802.11K capability is enabled.
Advertise Quiet IE	This value is used to determine if the Quiet IE should be advertised in the beacon frames. A value of "Enabled" allows the Quiet IE to be present in the beacon frames when 802.11K capability is enabled. A value of "Disabled" prevents the advertisement of the Quiet IE in the beacon frames when 802.11K capability is enabled.

5. Click **Save**.
6. Click **Pending Changes**.
7. In the **Pending Changes** window, select the check box and click **Deploy Changes**.

## In the CLI

To use the CLI to configure radio resource management information elements in the RRM IE profile, access the CLI in config mode and issue the following command:

```
(host) [node] (config) #wlan rrm-ie-profile <profile>
```

## Configuring Beacon Report Requests

The beacon report requests are sent only to 802.11k-compliant clients that advertise Beacon Report Capability in their RRM Enabled Capabilities IE. The beacon request frames are sent every 60 seconds.

The content of the report requests can be defined in the Beacon Report Request profile using the WebUI or CLI.

## In the WebUI

To select the information to be sent in beacon report requests using the WebUI:

1. Navigate to **Configuration>System>Profiles**.
2. Expand the **Wireless LAN** menu and select **Beacon Report Request**.
3. Select the Beacon Report Request profile you want to configure or create a new profile by clicking + and entering a name for the new profile in the **Profile Name** field.
4. Define the settings described in the table below.
5. Click **Save**.
6. Click **Pending Changes**.
7. In the **Pending Changes** window, select the check box and click **Deploy Changes**.

**Table 80:** Beacon Report Request Settings

Parameter	Description
Interface	This field is used to specify the Radio interface for transmitting the Beacon Report Request frame. It can have a value of either 0 or 1. The default value is 1.
Regulatory Class	This option is used to specify the Regulatory Class field in the Beacon Report Request frame. It can be set to one of the following: - <ul style="list-style-type: none"><li>• <b>1</b> (for 5 GHz band)</li><li>• <b>12</b> (for 2.4 GHz band)</li></ul>
Channel	This option is used to set the Channel field in the Beacon Report Request frame. The Channel value can be set to one of the following: - the channel of the AP (when Measurement Mode is set to either 'Passive' or 'Active-All channels') - 0 (when Measurement Mode is set to 'Beacon Table') - 255 (when Measurement Mode is set to 'Active-Channel Report')
Randomization Interval	This value is used to set the Randomization Interval field in the Beacon Report Request frame. The Randomization Interval is used to specify the desired maximum random delay in the measurement start time. It is expressed in units of TUs (Time Units). A Randomization Interval of 0 in a measurement request indicates that no random delay is to be used. This field can be given a value in the range (0, 65535). The default value is 0.



Parameter	Description
Measurement Duration	This value is used to set the Measurement Duration field in the Beacon Report Request frame. The Measurement Duration is set to the duration of the requested measurement. It is expressed in units of TUs. This field can be given a value in the range (0, 65535). The default value is 0.
Measurement Mode for Beacon Reports	<p>Click the <b>Measurement Mode for Beacon Reports</b> drop-down list and specify one of the following measurement modes:</p> <ul style="list-style-type: none"> <li>• <b>active-all-ch</b>—Enables active beacon measurement mode. In this mode, the client sends a probe request to the broadcast destination address on all supported channels, sets a measurement duration timer, and, at the end of the measurement duration, compiles all received beacons or probe response with the requested SSID and BSSID into a measurement report.</li> <li>• <b>active-ch-rpt</b>—In this mode, the client and returns a report that contains a list of channels in a regulatory class where a client is likely to find an AP, including the AP transmitting the AP channel report.</li> <li>• <b>beacon-table</b>—Enables beacon-table beacon measurement mode. In this mode, the client measures beacons and returns a report with stored beacon information for any supported channel with the requested SSID and BSSID. The client does not perform any additional measurements.</li> <li>• <b>passive</b>—Enables passive beacon measurement mode. In this mode, the client sets a measurement duration timer, and, at the end of the measurement duration, compiles all received beacons or probe response with the requested SSID and BSSID into a measurement report.</li> </ul> <p><b>NOTE:</b> If a station doesn't support the selected measurement mode, it returns a Beacon Measurement Report with the Incapable bit set in the Measurement Report Mode field. Default Mode: beacon-table</p>
Reporting Condition	This option is used to indicate the value for the "Reporting Condition" field in the Beacon Reporting Information sub-element present in the Beacon Report Request frame. It can have a range from 0 to 255. The default value is 0.
ESSID name	This option is used to indicate the value for the "SSID" field in the Beacon Report Request frame. It corresponds to the SSID Name for which the Beacon Report Request frame needs to be generated. It is a string with a minimum length of 1 and a maximum length of 32.
Reporting Detail	This option is used to indicate the value for the "Detail" field in the Reporting Detail sub-element present in the Beacon Report Request frame. It is set to "Disabled" by default.
Measurement Duration Mandatory	This value is used to set the "Duration Mandatory" bit of the Measurement Request Mode field of the Beacon Report Request frame. The default value is "Disabled".
Request Information values	This option is used to indicate the contents of the Request Information IE that could be present in the Beacon Report Request frame. The Request Information IE is present for all Measurement Modes except the 'Beacon Table' mode. It consists of a list of Element IDs that should be included by the client in the response frame.

## In the CLI

To select the information to be sent in beacon report requests using the command-line interface, access the CLI in config mode and issue the following commands.

```
(host) [node] (config) wlan bcn-rpt-req-profile <profile>
```

## Configuring Traffic Stream Measurement Report Requests

The Traffic Stream Measurement (TSM) report requests are sent only to 802.11k-compliant clients that advertise a traffic stream report capability. The TSM report request frames are sent every 60 seconds. The content of the report requests can be defined in the TSM Report Request profile using the WebUI or CLI.

### In the WebUI

To select the information to be sent in TSM report requests using the WebUI:

1. In the **Managed Network** node hierarchy, navigate to **Configuration>System>Profiles**.
2. Expand the **Wireless LAN** menu and select **TSM Report Request**.
3. Select the TSM Report Request profile you want to configure or create a new profile by clicking + and entering a name for the new profile in the **Profile Name** field.
4. Define the settings described in the table below.
5. Click **Save**.
6. Click **Pending Changes**.
7. In the **Pending Changes** window, select the check box and click **Deploy Changes**.

**Table 81:** TSM Report Request Settings

Parameter	Description
Request Mode for TSM Report Request	Select one of the following request modes: <ul style="list-style-type: none"><li>• normal</li><li>• triggered</li></ul> This value is used to determine the request mode for the Transmit Stream/Category Measurement Request frame. A Transmit Stream/Category Measurement Request frame can be sent in either normal mode or triggered mode. There are two options for this parameter <b>normal</b> and <b>triggered</b> . When the <b>triggered</b> option is selected, the Transmit Stream/Category Measurement Request frame is sent only when the trigger condition occurs. The default value for this field is <b>normal</b> .
Number of repetitions	This value is used to set the "Number of Repetitions" field in the Transmit Stream/Category Measurement Request frame. The <b>Number of Repetitions</b> field contains the requested number of repetitions for all the Measurement Request elements in this frame. A value of zero in this field indicates Measurement Request elements are executed once without repetition. A value of 65535 in the Number of Repetitions field indicates Measurement Request elements are repeated until the measurement is cancelled or superseded. This field has values in the range (0, 65535). The default value is 65535.
Duration Mandatory	This value is used to set the "Duration Mandatory" bit of the Measurement Request Mode field of the Transmit Stream/Category Measurement Request frame. The default value is <b>enabled</b> .

Parameter	Description
Randomization Interval	This value is used to set the Randomization Interval field in the Transmit Stream/Category Measurement Request frame. The Randomization Interval is used to specify the desired maximum random delay in the measurement start time. It is expressed in units of TUs (Time Units). When the request mode for the Transmit Stream/Category Measurement Request frame is set to "triggered", the Randomization Interval is not used and is set to 0. A Randomization Interval of 0 in a measurement request indicates that no random delay is to be used. This field can be given a value in the range (0, 65535). The default value is 0.
Measurement Duration	This value is used to set the Measurement Duration field in the Transmit Stream/Category Measurement Request frame. The Measurement Duration is set to the duration of the requested measurement. It is expressed in units of TUs. When the request mode for the Transmit Stream/Category Measurement Request frame is set to <b>triggered</b> , the Measurement Duration field should be set to 0. This field can be given a value in the range (0, 65535). The default value is 9776.
Traffic ID	The value is used to set the Traffic Identifier field in the Transmit Stream/Category Measurement Request frame. The Traffic Identifier field contains the TID subfield. The TID subfield indicates the TC or TS for which traffic is to be measured. This field can be given a value in the range (0, 255). The default value is 96
Bin 0 Range	This value is used to set the 'Bin 0 Range' field in the Transmit Stream/Category Measurement Request frame. Bin 0 Range indicates the delay range of the first bin (Bin 0) of the Transmit Delay Histogram, expressed in units of TUs. This field can be given a value in the range (0, 255). The default value is 6.

### In the CLI

To select the information to be sent in TSM report requests using the command-line interface, access the CLI in config mode and issue the following command.

```
(host) [node] (config) #wlan tsm-req-profile <profile>
```

## BSS Transition Management (802.11v)

BSS Transition Management enables an AP to request a voice client to transition to a specific AP, or suggest a set of preferred APs to a voice client, due to network load balancing or BSS termination. This helps the voice client identify the best AP to which that client should transition to as that client roams. ArubaOS supports BSS Transition Management features defined by the 802.11v standard.



Both the 802.11v BSS transition management features and the 802.11k radio resource management features are disabled by default. To enable both of these features, select the **Advertise 802.11k** Capability option in an 802.11k profile.

### Frame Types

BSS Transition Management uses the following frame types:

- **Query:** A Query frame is sent by the voice client that supports BSS transition management requesting a BSS transition candidate list to its associated AP, if the associated AP indicates that it supports the BSS transition capability.
- **Request:** An AP that supports BSS Transition Management responds to a BSS Transition Management Query frame with a BSS Transition Management Request frame. The AP may also send an unsolicited BSS Transition Management Request frame to a voice client at any time, if the client supports the BSS Transition Management capability. The Request frame also contains a Disassociation flag. If the flag is set, then the AP forcefully disassociates the client after 10 beacon intervals.
- **Response:** A Response frame is sent by the voice client back to the AP, informing whether it accepts or denies the transition.

### 802.11k and 802.11v clients

For 802.11k capable clients, the client management framework uses the actual beacon report generated by the client in response to a beacon report request sent by the AP. This beacon report replaces the virtual beacon report for that client. For 802.11v capable clients, the controller uses the 802.11v BSS Transition message to steer clients to the desired AP upon receiving a client steer trigger from the AP.

## Fast BSS Transition ( 802.11r)

ArubaOS provides support for Fast BSS Transition as part of the 802.11r implementation. Fast BSS Transition mechanism minimizes the delay when a voice client transitions from one BSS to another within the same ESS. Fast BSS Transition establishes security and QoS states at the target AP before or during a re-association. This minimizes the time required to resume data connectivity when a BSS transition happens.

The following table provides the modes in which Fast BSS Transition is supported:

**Table 82:** Supported VAP Forwarding Modes

VAP Forwarding Mode	Support for 802.11r
Tunnel Mode	Yes
Decrypt-Tunnel Mode	Yes
Split-Tunnel Mode	No
Bridge Mode	Beta quality

### Important Points to Remember

- Fast BSS Transition is operational only if the wireless client has support for 802.11r standard. If the client does not have support for 802.11r standard, it falls back to normal WPA2 authentication method.

## Configuring Fast BSS Transition

To enable and configure Fast BSS Transition on a configuration node, you must can create and configure an 802.11r profile using the WebUI or CLI.




---

Fast BSS transition is operational only with WPA2-Enterprise or WPA2-Personal.

---

## In the WebUI

1. In the **Managed Network** node hierarchy, navigate to the **Configuration > System > Profiles** window.
2. In the **All Profiles** list, expand the **Wireless LAN** menu, then select **802.11r**.
3. To edit an existing 802.11r profile, c select the 802.11r profile you want to edit. To create a new 802.11r Profile, click + and enter a name for the new 802.11r profile name in the profile name field.
4. Configure the following 802.11r radio settings.
  - a. Select the **Advertise 802.11r Capability** option to allow Virtual APs using this profile to advertise 802.11r capability.
  - b. Enter the mobility domain ID value (1-65535) in the **802.11r Mobility Domain ID** field. The default value is 1.
  - c. Enter the R1 Key timeout value in seconds (60-86400) for decrypt-tunnel or bridge mode in the **802.11r R1 Key Duration** field. The default value is 3600.
5. Click **Save**.
6. Click **Pending Changes**.
7. In the **Pending Changes** window, select the check box and click **Deploy Changes**.

## In the CLI

Create an 802.11r profile using the following command:

```
(host) [node] (config) #wlan dot11r-profile <profile> dot11r
```

## Troubleshooting Fast BSS Transition

ArubaOS provides various troubleshooting options to verify the Fast BSS Transition functionalities.

In decrypt-tunnel mode and bridge mode, each r0 key generates up to four r1 keys and the managed device pushes each r1 key to the corresponding AP. The following commands help verifying the pushing functionality:

Execute the following command to view all the r1 keys that are stored in an AP:

```
(host) [node] (config) #show ap debug dot11r state
```

You can use the following command to remove an r1 key from an AP when the AP does not have a cached r1 key during Fast BSS Transition roaming:

```
(host) [node] #ap debug dot11r remove-key
```

Execute the following command to view the hit/miss rate of r1 keys cached on an AP before a Fast BSS Transition roaming. This counter helps to verify if enough r1 keys are pushed to the neighboring APs.

```
(host) (config) #show ap debug dot11r efficiency <client-mac>
```

## WLAN SSID Profiles

A Service Set Identifier (SSID) is the network or WLAN that any client sees. A SSID profile defines the name of the network, authentication type for the network, basic rates, transmit rates, SSID cloaking, and certain WMM settings for the network.

### SSID Profile Overview

ArubaOS supports different types of the Advanced Encryption Standard (AES), Temporal Key Integrity Protocol (TKIP), and wired equivalent privacy (WEP) encryption. AES is the most secure and recommended encryption method. Most modern devices are AES capable and AES should be the default encryption method. Use TKIP only when the network includes devices that do not support AES. In these situations, use a separate SSID for devices that are only capable of TKIP.

## Suite-B Cryptography

The Suite-B (bSec) protocol is a pre-standard protocol that has been proposed to the IEEE 802.11 committee as an alternative to 802.11i. The main difference between bSec and standard 802.11i is that bSec implements Suite-B algorithms wherever possible. Notably, AES-CCM is replaced by AES-GCM, and the Key Derivation Function (KDF) of 802.11i is upgraded to support SHA-256 and SHA-384. In order to provide interoperability with standard Wi-Fi software drivers, bSec is implemented as a shim layer between standard 802.11 Wi-Fi and a Layer 3 protocol such as IP. A managed device configured to advertise a bSec SSID will advertise an open network, however only bSec frames will be permitted on the network.



---

This feature requires the ACR license.

---

The bSec protocol requires that you use VIA 2.1.1 or greater on the client device. Consult VIA documentation for more information on configuring and installing VIA.

The bSec protocol is available in 128-bit mode and 256-bit mode. The number of bits specifies the length of the AES-GCM encryption key. Using United States Department of Defense classification terminology, bSec-128 is suitable for protection of information up to the SECRET level, while bSec-256 is suitable for protection of information up to the TOP SECRET level.

Suite-B AES-128-GCM and AES-256-GCM encryption is supported by the ArubaOS hardware.

## Wi-Fi Multimedia Protection

Wi-Fi Multimedia™ (WMM®) is a Wi-Fi Alliance® certification program that is based on the IEEE 802.11e amendment. WMM ensures QoS for latency-sensitive traffic in the air. WMM divides the traffic into four queues or access categories:

- voice
- video
- best effort
- background

## Management Frame Protection

ArubaOS supports the IEEE 802.11w standard, also known as Management Frame Protection (MFP). MFP makes it difficult for an attacker to deny service by spoofing Deauth and Disassoc management frames. MFP uses 802.11i (Robust Security Network) framework that establishes encryption keys between the client and AP.

MFP is configured on a virtual AP (VAP) as part of the wlan ssid-profile. There are two parameters that can be configured, mfp-capable and mfp-required. Both are disabled by default.



---

MFP can only be enabled on SSIDs that support WPA2. MFP is not supported on virtual APs using tunnel forwarding mode.

---

## Configuring the SSID Profile

Follow the procedures below to create a new SSID profile and associate that profile to your Virtual AP.

### In the WebUI

1. In the **Managed Network** node hierarchy, navigate to **Configuration > System > All Profiles**.
2. In the **Profiles** list, expand the **Wireless LAN** menu, then select **SSID**.

3. Select the existing SSID profile from the Profile Details pane, or create a new profile by clicking + and entering a name for the new profile in the **Profile Name** field.
4. Configure the SSID profile parameters described in [Table 83](#).
5. Click **Save**.
6. Click **Pending Changes**.
7. In the **Pending Changes** window, select the check box and click **Deploy Changes**.

**Table 83:** *SSID Profile Parameters*

Parameter	Description
SSID Enable	Click this check box to enable or disable the SSID. The SSID is enabled by default.
ESSID	Name that uniquely identifies a wireless network. The network name, or <i>ESSID</i> can be up to 31 characters. If the ESSID includes spaces, you must enclose it in quotation marks.
Encryption	Select one of the following encryption types:
xSec	Encryption and tunneling of Layer-2 traffic between the controller and wired or wireless clients, or between controllers. To use xSec encryption, you must use a RADIUS authentication server. For clients, you must install the Funk Odyssey client software.  Requires installation of the xSec license. For xSec between managed devices, you must install an xSec license in each managed device.
opensystem	No authentication and encryption.
static-wep	WEP with static keys.
dynamic-wep	WEP with dynamic keys.
wpa-tkip	WPA with TKIP encryption and dynamic keys using 802.1X.
wpa-aes	WPA with AES encryption and dynamic keys using 802.1X.
wpa-psk-tkip	WPA with TKIP encryption using a preshared key.
wpa-psk-aes	WPA with AES encryption using a preshared key.
wpa2-aes	WPA2 with AES encryption and dynamic keys using 802.1X.
wpa2-psk-aes	WPA2 with AES encryption using a preshared key.
wpa2-psk-tkip	WPA2 with TKIP encryption using a preshared key.
wpa2-tkip	WPA2 with TKIP encryption and dynamic keys using 802.1X.

**Table 83: SSID Profile Parameters**

Parameter	Description
wpa2-aes-gcm-128	WPA2 with AES GCM-128 (Suite-b) encryption and dynamic keys using 802.1X. <b>NOTE:</b> This parameter requires the ACR license. For further information on Suite-B encryption, see <a href="#">Suite-B Cryptography on page 430</a> .
wpa2-aes-gcm-256	WPA2 with AES GCM-256 (Suite-b) encryption and dynamic keys using 802.1X. <b>NOTE:</b> This parameter requires the ACR license. For further information on Suite-B encryption, see <a href="#">Suite-B Cryptography on page 430</a> .
Enable Management Frame Protection	When selected, the SSID supports MFP-capable and traditional clients. <b>NOTE:</b> MFP can only be enabled on SSIDs that support WPA2.
Require Management Frame Protection	When selected, the SSID supports MFP-capable clients only. <b>NOTE:</b> MFP can only be enabled on SSIDs that support WPA2.
DTIM Interval	Specifies the interval, in milliseconds, between the sending of Delivery Traffic Indication Messages (DTIMs) in the beacon. This is the maximum number of beacon cycles before unacknowledged network broadcasts are flushed. When using wireless clients that employ power management features to sleep, the client must revive at least once during the DTIM period to receive broadcasts
802.11a Basic Rates	Select the set of supported 802.11a rates, in Mbps, that are advertised in beacon frames and probe responses.
802.11a Transmit Rates	Select the set of 802.11a rates at which the AP is allowed to send data. The actual transmit rate depends on what the client is able to handle, based on information sent at the time of association and on the current error/loss rate of the client.
802.11g Basic Rates	Select the set of supported 802.11b/g rates that are advertised in beacon frames and probe responses.
802.11g Transmit Rates	Select the set of 802.11b/g rates at which the AP is allowed to send data. The actual transmit rate depends on what the client is able to handle, based on information sent at the time of association and on the current error/loss rate of the client.
Station Ageout Time	Time, in seconds, that a client is allowed to remain idle before being aged out.
Max Transmit Attempts	Maximum number of retries allowed for the AP to send a frame.
RTS Threshold	Wireless clients transmitting frames larger than this threshold must issue Request to Send (RTS) and wait for the AP to respond with Clear to Send (CTS). This helps prevent mid-air collisions for wireless clients that are not within wireless peer range and cannot detect when other wireless clients are transmitting.



**Table 83: SSID Profile Parameters**

Parameter	Description
	The default value is 2333 bytes.
Short Preamble	Click this check box to enable or disable a short preamble for 802.11b/g radios. Network performance may be higher when short preamble is enabled. In mixed radio environments, some 802.11b wireless client stations may experience difficulty associating with the AP using short preamble. To use only long preamble, disable short preamble. Legacy client devices that use only long preamble generally can be updated to support short preamble.
Max Associations	Maximum number of wireless clients per radio for the SSID (subject to an AP limit of 255 clients per radio).  The supported range is 0-255 clients. Default value is 64.
Wireless Multimedia (WMM)	Enables or disables WMM, also known as IEEE 802.11e Enhanced Distribution Coordination Function (EDCF). WMM provides prioritization of specific traffic relative to other traffic in the network.
Wireless Multimedia U-APSD (WMM-UAPSD) Powersave	Enable Wireless Multimedia (WMM) UAPSD powersave.
WMM TSPEC Min Inactivity Interval	Specify the minimum inactivity time-out threshold of WMM traffic. This setting is useful in environments where low inactivity interval time-outs are advertised, which may cause unwanted timeouts.  The supported range is 0-3,600,000 milliseconds, and the default value is 0 milliseconds.
DSCP mapping for WMM voice AC	DSCP used to map WMM voice traffic.  The supported range is 0-63.
DSCP mapping for WMM video AC	Select the DSCP used to map WMM video traffic.  The supported range is 0-63.
DSCP mapping for WMM best-effort AC	Select the DSCP value used to map WMM best-effort traffic.  The supported range is 0-63.
DSCP mapping for WMM background AC	Select the DSCP used to map WMM background traffic.  The supported range is 0-63.
Hide SSID	Select this check box to enable or disable the hiding of the SSID name in beacon frames. Note that hiding the SSID does very little to increase security.
Deny_Broadcast Probes	When a client sends a broadcast probe request frame to search for all available SSIDs, this option controls whether or not the system responds for this SSID. When enabled, no response is sent and clients have to know the SSID in order to associate to the SSID. When disabled, a probe response frame is sent for this SSID.

**Table 83: SSID Profile Parameters**

Parameter	Description
Local Probe Request Threshold (dB)	Enter the SNR threshold below which incoming probe requests will get ignored. The supported range of values is 0-100 dB. A value of 0 disables this feature.
Disable Probe Retry	Click this check box to enable or disable battery MAC level retries for probe response frames. By default this parameter is enabled, which mean that MAC level retries for probe response frames is disabled. <b>NOTE:</b> This parameter is not supported for 200 Series access points.
Battery Boost	Converts multicast traffic to unicast before delivery to the client, thus allowing you to set a longer DTIM interval. The longer interval keeps associated wireless clients from activating their radios for multicast indication and delivery, leaving them in power-save mode longer and thus lengthening battery life.  This parameter requires the PEFNG license.
WEP Key 1	First static WEP key associated with the key index. Can be 10 or 26 hex characters in length.
WEP Key 2	Second static WEP key associated with the key index. Can be 10 or 26 hex characters in length.
WEP Key 3	Third Static WEP key associated with the key index. Can be 10 or 26 hex characters in length.
WEP Key 4	Fourth Static WEP key associated with the key index. Can be 10 or 26 hex characters in length.
WEP Transmit Key Index	Key index that specifies which static WEP key is to be used. Can be 1, 2, 3, or 4.
WPA Hexkey	WPA pre-shared key (PSK).
WPA Passphrase	WPA passphrase with which to generate a pre-shared key (PSK).
Maximum Transmit Failures	The AP assumes the client has left and should be deauthorized when the AP detects this number of consecutive frames were not delivered because the maximum retry threshold as been exceeded.
BC/MC Rate Optimization	Click this check box to enable or disable scanning of all active stations currently associated to an AP to select the lowest transmission rate for broadcast and multicast frames. This option only applies to broadcast and multicast data frames; 802.11 management frames are transmitted at the lowest configured rate. <b>NOTE:</b> Do not enable this parameter unless instructed to do so by your Aruba technical support representative.

**Table 83: SSID Profile Parameters**

Parameter	Description																																																																				
Rate Optimization for delivering EAPOL frames	Click this check box to use a more conservative rate for more reliable delivery of EAPOL frames.																																																																				
Strict Spectralink Voice Protocol (SVP)	Click this check box to enable Strict Spectralink Voice Protocol (SVP)																																																																				
802.11g Beacon Rate	Click this drop-down list to select the beacon rate for 802.11g (use for Distributed Antenna System (DAS) only). Using this parameter in normal operation may cause connectivity problems.																																																																				
802.11a Beacon Rate	Click this drop-down list to select the beacon rate for 802.11a (use for Distributed Antenna System (DAS) only). Using this parameter in normal operation may cause connectivity problems.																																																																				
Video Multicast Rate Optimization	<p>When configured, the controller chooses the rate for video multicast frames. You can configure Modulation Coding Scheme (MCS) rates as well. MCS is an important setting because it provides for potentially greater throughput.</p> <p><b>NOTE:</b> The following information displays the MCS rate if the <b>Short guard interval in 20 MHz mode</b> setting in <b>High-throughput SSID profile</b> is either enabled or disabled:</p> <table border="1"> <thead> <tr> <th>MCS</th> <th>Streams</th> <th>20 MHz</th> <th>20 MHz SGI</th> </tr> </thead> <tbody> <tr><td>0</td><td>1</td><td>6.5</td><td>7.2</td></tr> <tr><td>1</td><td>1</td><td>13.0</td><td>14.4</td></tr> <tr><td>2</td><td>1</td><td>19.5</td><td>21.7</td></tr> <tr><td>3</td><td>1</td><td>26.0</td><td>28.9</td></tr> <tr><td>4</td><td>1</td><td>39.0</td><td>43.3</td></tr> <tr><td>5</td><td>1</td><td>52.0</td><td>57.8</td></tr> <tr><td>6</td><td>1</td><td>58.5</td><td>65.0</td></tr> <tr><td>7</td><td>1</td><td>65.0</td><td>72.2</td></tr> <tr><td>8</td><td>2</td><td>13.0</td><td>14.4</td></tr> <tr><td>9</td><td>2</td><td>26.0</td><td>28.9</td></tr> <tr><td>10</td><td>2</td><td>39.0</td><td>43.3</td></tr> <tr><td>11</td><td>2</td><td>52.0</td><td>57.8</td></tr> <tr><td>12</td><td>2</td><td>78.0</td><td>86.7</td></tr> <tr><td>13</td><td>2</td><td>104.0</td><td>115.6</td></tr> <tr><td>14</td><td>2</td><td>117.0</td><td>130.0</td></tr> <tr><td>15</td><td>2</td><td>130.0</td><td>144.4</td></tr> </tbody> </table> <p><b>NOTE:</b> The MCS rates for video multicast are supported in all 802.11n-capable APs. This is not supported in 320 Series AP.</p>	MCS	Streams	20 MHz	20 MHz SGI	0	1	6.5	7.2	1	1	13.0	14.4	2	1	19.5	21.7	3	1	26.0	28.9	4	1	39.0	43.3	5	1	52.0	57.8	6	1	58.5	65.0	7	1	65.0	72.2	8	2	13.0	14.4	9	2	26.0	28.9	10	2	39.0	43.3	11	2	52.0	57.8	12	2	78.0	86.7	13	2	104.0	115.6	14	2	117.0	130.0	15	2	130.0	144.4
MCS	Streams	20 MHz	20 MHz SGI																																																																		
0	1	6.5	7.2																																																																		
1	1	13.0	14.4																																																																		
2	1	19.5	21.7																																																																		
3	1	26.0	28.9																																																																		
4	1	39.0	43.3																																																																		
5	1	52.0	57.8																																																																		
6	1	58.5	65.0																																																																		
7	1	65.0	72.2																																																																		
8	2	13.0	14.4																																																																		
9	2	26.0	28.9																																																																		
10	2	39.0	43.3																																																																		
11	2	52.0	57.8																																																																		
12	2	78.0	86.7																																																																		
13	2	104.0	115.6																																																																		
14	2	117.0	130.0																																																																		
15	2	130.0	144.4																																																																		
Advertise QBSS Load IE	<p>Click this check box to enable the AP to advertise the QBSS load element. The element includes the following parameters that provide information on the traffic situation:</p> <ul style="list-style-type: none"> <li>• <b>Station count:</b> The total number of stations associated to the QBSS.</li> <li>• <b>Channel utilization:</b> The percentage of time (normalized to 255) the channel is sensed to be busy. The access point uses either the physical or the virtual carrier sense mechanism to sense a busy channel.</li> <li>• <b>Available admission capacity:</b> The remaining amount of medium time (measured as number of 32us/s) available for a station via explicit</li> </ul>																																																																				

**Table 83: SSID Profile Parameters**

Parameter	Description
	<p>admission control.</p> <p>The QAP uses these parameters to decide whether to accept an admission control request. A wireless station uses these parameters to choose the appropriate access points.</p> <p><b>NOTE:</b> Ensure that WMM is enabled for legacy APs to advertise the QBSS load element. For 802.11n APs, ensure that either WMM or high throughput is enabled.</p>
Advertise Location Information	<p>When this option is enabled, APs broadcast their location within a IE carried in Beacon frames and Probe Response frames. The AP's latitude, longitude and altitude can be configured on the <b>Configuration &gt; Wireless &gt; AP Installation</b> page of the controller WebUI, or using the <b>provision-ap</b> command in the controller command-line interface.</p>
Advertise AP Name	<p>If this parameter is enabled, APs will broadcast the AP name configured by the <b>ap-name</b> command. This option is disabled by default.</p>
Enforce User VLAN for Open Stations	<p>Select this option to restrict data traffic from open stations to the user's assigned VLAN. This option is disabled by default.</p>
Enable OKC	<p>Opportunistic Key Caching (OKC) is a similar technique, not defined by 802.11i, available for authentication between multiple APs in a network where those APs are under common administrative control. An Aruba deployment with multiple APs under the control of a single controller is one such example. Using OKC, a station roaming to any AP in the network will not have to complete a full authentication exchange, but will instead just perform the 4-way handshake to establish transient encryption keys.</p>

### In the CLI

```
(host) [node] (config) #wlan ssid-profile <profile>
```

## WLAN Authentication

The [WLAN Wizard](#) allows you to define the type of authentication used by clients associating to a WLAN. The WLAN wizard is the recommend method for defining WLAN settings, but advanced users can also define authentication settings manually via the AAA profile in the WebUI or command-line interfaces.

### Configuring an AAA Profile in the WebUI

1. In the **Managed Network** node hierarchy, navigate to **Configuration > Authentication > AAA Profiles**.
2. Click + to define AAA profile settings for the selected configuration node.
3. Enter a name for the profile in the **Profile name** field, then configure the AAA profile parameters described in [Table 84](#).
4. Click **Save**.
5. Click **Pending Changes**.
6. In the **Pending Changes** window, select the check box and click **Deploy Changes**.

**Table 84: AAA Profile Parameters**

Parameter	Description
Initial role	Click the <b>Initial Role</b> drop-down list and select a role for unauthenticated users. The default role for unauthenticated users is <b>logon</b> .
MAC Authentication Default Role	Click the MAC Authentication Default Role drop-down list and select the role assigned to the user when the device is MAC authenticated. The default role for MAC authentication is the <b>guest</b> user role. If derivation rules are present, the role assigned to the client through these rules take precedence over the default role. <b>NOTE:</b> This feature requires the PEFNG license.
802.1X Authentication Default Role	Click the <b>802.1X Authentication Default Role</b> drop-down list and select the role assigned to the client after 802.1X authentication. The default role for 802.1X authentication is the <b>guest</b> user role. If derivation rules are present, the role assigned to the client through these rules take precedence over the default role. <b>NOTE:</b> This feature requires the PEFNG license.
User idle timeout	Select the <b>Enable</b> check box to configure user idle timeout value for this profile. Specify the idle timeout value for the client in seconds. A value of 0, deletes the user immediately after disassociation from the wireless network. Valid range is 30-15300 in multiples of 30 seconds. Enabling this option overrides the global settings configured in the AAA timers. If this is disabled, the global settings are used.
RADIUS Interim Accounting	When this option is enabled, the RADIUS accounting feature allows the managed device to send Interim-Update messages with current user statistics to the server at regular intervals. This option is disabled by default, allowing the managed device to send only start and stop messages to the RADIUS accounting server.
User derivation rules	Click the <b>User derivation</b> rules drop-down list and specify a user attribute profile from which the user role or VLAN is derived.
Wired to Wireless Roaming	Enable this feature to keep users authenticated when they roam from the wired side of the network. This feature is enabled by default.
SIP authentication role	Click the <b>SIP authentication</b> role drop-down list and specify the role assigned to a session initiation protocol (SIP) client upon registration. <b>NOTE:</b> This feature requires the PEFNG license.
Device Type Classification	When you select this option, the managed device will parse user-agent strings and attempt to identify the type of device connecting to the AP. When the device type classification is enabled, the Global client table shown in the <b>Monitoring&gt;Network &gt; All WLAN Clients</b> window shows each client's device type, if that client device can be identified.

Parameter	Description
Enforce DHCP	<p>When you select this option, clients must obtain an IP using DHCP before they are allowed to associate to an AP. Enable this option when you create a user rule that assigns a specific role or VLAN based upon the client device's type. For details, see <a href="#">Working with User-Derived VLANs on page 379</a>.</p> <p><b>NOTE:</b> If a client is removed from the user table by the "Logon user lifetime" AAA timer, then that client will not be able to send traffic until it renews its DHCP.</p> <p><b>NOTE:</b> Enforce DHCP is available on the managed device for APs configured for tunnel or decrypt-tunnel forwarding mode only.</p>
PAN firewalls Integration	<p>Requires IP mapping at Palo Alto Networks firewalls. For details, see <a href="#">Palo Alto Networks Firewall Integration on page 632</a>.</p>
Open SSID RADIUS Accounting	<p>Initiates RADIUS accounting as soon as the user associates to an Open SSID without any authentication.</p> <p><b>NOTE:</b> Do not enable this parameter for wired users. If enabled, the managed device sends RADIUS accounting packets for unauthenticated wired users.</p>

## Configuring an AAA Profile in the CLI

```
(host) [node] (config) #aaa authentication dot1x <profile>
(host) [node] (config) #aaa profile <profile>
```

AirMatch is the next generation radio resource management service introduced in ArubaOS 8.0 for devices in a Mobility Master/managed device topology. AirMatch provides RF network resource allocation with unprecedented quality. It analyzes the past 24 hours of RF network statistics and proactively optimizes the network for the next day. Any RF plan change is applied in the early morning to minimize client disruption and maximize the user experience. AirMatch can react to detrimental RF events, such as radar and high noise levels, to allow the network to manage sudden changes in the RF environment.

Stand-alone controllers support only the Adaptive Radio Management (ARM) and ClientMatch features, which use automatic, infrastructure-based controls to maximize client performance and enhance the stability and predictability of the Wi-Fi network.



---

AirMatch and ARM cannot be used together. ArubaOS 8.x does not support AirMatch on a standalone controller in master controller mode. A Mobility Master deployment that includes managed devices does not support Adaptive Radio Management.

---

### RF Management for Mobility Master Deployments with Managed Devices

The following sections provide a general overview of the RF management used by a multi-controller deployment managed by Mobility Master.

- [AirMatch RF Management Overview on page 439](#)
- [ClientMatch Overview on page 441](#)

The sections below describe the procedures to configure AirMatch and ClientMatch:

- [Configuring AirMatch on page 444](#)
- [Configuring ClientMatch on page 445](#)

### RF Management for Deployments with a Stand-alone Controller

The following sections provide a general overview of the RF management used by stand-alone controllers:

- [RF Management for Stand-alone Controller Deployments on page 446](#)
- [ClientMatch Overview on page 441](#)

The sections below describe the steps to configure advanced ARM settings and troubleshoot common ARM issues:

- [ARM Coverage and Interference Metrics on page 452](#)
- [Configuring ARM Profiles on page 453](#)
- [Troubleshooting ARM on page 459](#)

## AirMatch RF Management Overview



---

ArubaOS 8.x does not support AirMatch in master controller mode.

---

The AirMatch channel and EIRP optimization features deprecate the channel planning and EIRP optimization features in the legacy Adaptive Radio Management (ARM) feature. AirMatch is supported on Mobility Master

only, while legacy ARM channel optimization and EIRP features continue to be supported by stand-alone controllers running ArubaOS 8.0.

AirMatch channel planning evens out channel distributions in any size of network, and in any subset of the contiguous network (as much as allowed by the network configuration, regulatory domain, and AP hardware capability). AirMatch also minimizes channel coupling, where adjacent radios are assigned to the same channel. The computing power of Mobility Master impacts channel distribution calculations, so channel coupling may occasionally be allowed in complex networks to keep the computing time practical.

AirMatch EIRP planning automatically considers the local density of the network to manage the APs' coverage and modulation and coding scheme (MCS) operation, and optimizes EIRP changes across neighboring AP radios in order to offer users the best roaming experience.

[Table 85](#) describes some of the differences between the channel and EIRP optimization features supported by ArubaOS AirMatch and ArubaOS ARM.

**Table 85:** *AirMatch and ARM in ArubaOS*

Features	AirMatch	ARM
Initial Release	ArubaOS 8.0	ArubaOS 2.x
Supported Topology	Mobility Master / Managed device	Stand-alone controller
Run Period	24 hours	As little as 5 minutes
RF information used	Past 24 hours of RF data	Instantaneous snapshot of the RF environment
Deployment Time	5 AM (by default) , or any time necessary	Any time necessary
Computing Time	Depends upon network size	Less than 1 second
Optimization Scope	The entire RF network	Each individual AP

## AirMatch Channel Assignments

Each AP in a Mobility Master deployment measures its RF environment for a five minute period, every 30 minutes by default. The AP then sends AMON messages about the radio feasibility to the managed device based on that AP's hardware capability, radio and regulatory domain, and RF neighbors. The managed device forwards these messages to the Mobility Master. The Mobility Master adds this information to a database, computes an optimal solution, and deploys the latest RF plan by sending updated settings to the APs. By default, this configuration update is sent at 5 AM (as per the Mobility Master system clock), but time of this configuration update can be modified via the AirMatch profile.

---

An exception to this daily update is an automatic channel change due to a radar detection event or high noise interference. If an AP detects a radar event on its current operating channel, that AP automatically changes to another supported channel to avoid radar interference, and does not wait for the daily RF configuration update from the Mobility Master. An AP may also automatically change channels if a very high noise level is detected on the current channel, if at least one other channel is free of noise.

---



**NOTE**



In ArubaOS 8.0, AirMatch moves a radio to a random channel when a radar event is detected, or if a high noise floor is detected on a non-static channel. Starting with ArubaOS 8.0.1, AirMatch uses the criteria described in [Table 86](#) to assign a new channel.

**Table 86:** Channel Assignment Logic

Issue Prompting Channel Change	Channel Selection Criteria
Detected radar	AirMatch selects a channel with a minimum interference index from the channels without high noise or a radar condition.
High channel noise	<p>The channel selection criteria varies between static and non-static channels.</p> <ul style="list-style-type: none"> <li>• If static channel is configured, the channel does not change due to a high noise condition.</li> <li>• For a non-static channel, AirMatch selects a channel with a minimum interference index from the channels without high noise or a radar condition.</li> </ul>

## Channel Quality Improvement Thresholds

ArubaOS 8.0.1 introduces the AirMatch channel quality improvement threshold, which allows you to select the minimum channel improvement that can trigger a new scheduled channel solution. The default threshold value is a 15% improvement. If a proposed channel change will not produce an improvement that meets or exceeds this threshold, AirMatch will not trigger a channel change.



This channel quality setting only applies to scheduled updates. If you manually trigger an update using the **airmatch runnow** command, AirMatch will deploy the new solution regardless of the level of improvement.

## Initial RF Calculations

The database for the AirMatch service is empty when Mobility Master first boots up. When Mobility Master first detects APs on the network, it enters its initial optimization phase, collects data from all the APs, and generates an incremental solution every 30 minutes (by default) for the next eight hours. When this initial eight-hour period has elapsed, the AirMatch service will periodically calculate a new RF configuration for these devices.

When a new AP is deployed on a network with an active Mobility Master during the initial 8-hour AirMatch optimization phase, that AP joins the network with its preassigned channel and transmission power values. The AirMatch service detects the newly deployed AP on the network, restarts its RF computations, and sends an incremental RF configuration update to the new AP 30 minutes later. APs added to the network after the initial 8-hour optimization period will not receive an additional RF configuration update until the next scheduled update period.

## ClientMatch Overview

ClientMatch continually monitors a client's RF neighborhood to provide ongoing client bandsteering and load balancing, and enhanced AP reassignment for roaming mobile clients.



Legacy 802.11a/b/g devices do not support ClientMatch. When you enable ClientMatch on 802.11n-capable devices, ClientMatch overrides any settings configured for the legacy bandsteering or load balancing features. 802.11ac-capable devices do not support the legacy bandsteering, station hand off or load balancing settings, so these APs must be managed on using ClientMatch.

The managed device aggregates information it receives from all APs using ClientMatch, and maintains information for all associated clients in a database. The managed device shares this database with the APs (for their associated clients), and the APs use the information to compute the client-based RF neighborhood and determine which APs should be considered candidate APs for each client. When the managed device receives a client steer request from an AP, the managed device identifies the optimal AP candidate and manages the client's relocation to the desired radio. This is an improvement from previous releases, where ARM was managed exclusively by APs, without the larger perspective of the client's RF neighborhood.

In Mobility Master/managed device deployments where APs are connected to a managed device that is associated to Mobility Master, the AP sends RF neighborhood information to the managed device, which then forwards that information to the Mobility Master. The Mobility Master receives probe reports from all managed devices and generates a Virtual Beacon Report (VBR) for each client. These VBRs are sent from the Mobility Master to the managed device, and then to the AP to which the client is associated. APs associated to a stand-alone controller receive and collect information about clients in their neighborhood, and periodically send this information to the controller, which in turn generates VBRs and sends them directly back to the APs.

The following client/AP mismatch conditions are managed by ClientMatch:

- **Load Balancing:** ClientMatch balances clients across APs on different channels, based upon the client load on the APs and the SNR levels that the client detects from an underused AP. If an AP radio can support additional clients, the AP will participate in ClientMatch load balancing, and clients can be directed to that AP radio, subject to predefined SNR thresholds.
- **Sticky Clients:** ClientMatch also helps mobile clients that tend to stay associated to an AP despite low signal levels. APs using ClientMatch continually monitor the client's RSSI as it roams between APs, and moves the client to an AP when a better radio match is found. This prevents mobile clients from remaining associated to an APs with a less than ideal RSSI, which can cause poor connectivity and reduce performance for other clients associated with that AP.
- **Band Steering/Band Balancing:** APs using the ClientMatch feature monitor the RSSI for clients that advertise dual-band capability. If a client is currently associated to a 2.4 GHz radio, and the AP detects that the client has a good RSSI from the 5 GHz radio, the managed device attempts to steer the client to the 5 GHz radio, as long as the 5 GHz RSSI is not significantly worse than the 2.4 GHz RSSI, and the AP retains a suitable distribution of clients on each of its radios.

## Incremental Rules-Based ClientMatch Updates

The ClientMatch rules that manage client associations are based primarily upon the client's RF environment and apply uniformly to all client types, regardless of device type or operating system. ArubaOS 8.0 supports incremental updates to ClientMatch rules to support network devices running newer operating systems that may be incompatible with the existing ClientMatch client association rules. This feature allows the managed device to use a newer set of ClientMatch rules without updating the entire operating system, reducing network downtime.

## BSS Transition Management Support

The BSS Transition Management Support feature allows ClientMatch to steer devices using 802.11v BSS transition management standards for continuous wireless connectivity. This feature provides a seamless standards-compatible method of device steering in wireless networks, as 802.11v BSS transition management support has become increasingly common in wireless devices.

When ClientMatch attempts to steer the client to a more optimal AP, it sends out an 802.11v BSS transition management request to the 11v capable station and waits for a response.

1. ClientMatch begins a timeout session for the BSS transition management response or new association request to the desired AP.

2. If the request is rejected or the timeout session expires, ClientMatch is notified of the failed attempt and reinitiates the steer using the 802.11v BSS transition management request.
  - If the client steer fails the maximum number of timeout attempts (default: 5), ClientMatch marks the client as 11v unsupported and falls back to using deauths to steer.
  - If the client steer fails due to request rejection, ClientMatch does not mark the client as 11v unsupported and continues to attempt to steer using the 802.11v BSS transition management request.

## Multi-Media Sync-Up

ClientMatch offers a tighter integration with multiple media-aware ALGs to provide better call quality for programs like Skype for Business (Skype4b) and Facetime. With ClientMatch's ability to understand various media protocols, clients are not steered to different APs in the middle of an active media session.

When a client participates in a call, the managed device learns about the media session and sends this information to the AP to which the client is currently associated, as part of the variable bitrate (VBR) update. When the AP learns that the client is in a call, it will not attempt to steer the client to another AP until the managed device indicates that the call has ended, allowing calls to run more smoothly without any disruptions to the ongoing media flow.

## Multi-User MIMO Steering

Multi-user MIMO, or MU-MIMO Steering, groups multi-user-capable (MU-capable) clients to maximize the likelihood of MIMO transmissions, which increases downstream throughput performance in 802.11ac Wave 2 (gen 2) APs. MU-MIMO runs on MU-capable clients with traffic flows and PHY channels compatible for multi-user transmissions. ClientMatch steers and aligns MU-MIMO-capable clients with MU-MIMO-capable radios using SNR values. Multiple MU-MIMO-capable clients can be grouped together on a MU-MIMO-capable radio.

Successful MU-MIMO transmissions depend on the following:

- Traffic streams that can be multiplexed for MIMO transmissions. This is dependent on packet length and traffic flow rates (packet arrival rates) from APs to the devices.
- MU-MIMO-capable clients associated to the same radio, whose PHY channel matrices are compatible for simultaneous multi-user transmissions

In an 802.11ac AP deployment, clients indicate VHT capabilities for probe requests and association requests, including MU-MIMO support. The APs and managed devices use this information to determine whether the client is MU-MIMO-capable.

After the MU-MIMO-capable clients are located, they are steered to an appropriate MU-MIMO-capable radio. MU-MIMO Steering ensures that steers are compatible with existing trigger thresholds, such as sticky clients and load-balancing. The multi-user SNR threshold of the target radio must be greater than the sticky client SNR threshold, and radios that exceed the client threshold are avoided to prevent the need for load-balancing.

## Removing VBR Dependency on Probe Requests

ClientMatch has shifted its dependency on probe requests to the Air Monitor (AM) data feeds for virtual beacon report (VBR) data. Instead of relying solely on client background scans during probe requests, which can cause limitations due to low scanning frequency, ClientMatch uses AM data feeds to gain more continuous, comprehensive client RSSI feeds. Along with probe requests, Air Monitor data feeds collect client information during AP scanning using the following frames:

- Block ACK
- Management frames
- NULL data frames
- Data frames with rates no higher than 36Mbps
- Control frames

## Configuring AirMatch

The range of RF settings that can be assigned to an the AP via the AirMatch feature is defined in the 2.4 GHz and 5 GHz radio profiles on the managed device. You can access these settings on the Mobility Master WebUI by selecting the configuration for the managed device from the configuration hierarchy, then navigating to the **Configuration > AP Groups > Radio** and **Configuration > Access Points > Radio** pages. Use these pages to specify the radio mode and range of channels and maximum channel bandwidth that can be assigned to an AP or AP group via an AirMatch solution. The AirMatch feature will not assign an AP a channel that does not fall within the group of valid channels or channel bandwidth ranges allowed by that AP's 2.4 GHz and 5 GHz radio profile.

The AirMatch feature performs automatic daily updates by default, but you can use the Mobility Master WebUI or command-line interface to disable daily updates for APs at one or more configuration nodes, allowing those APs and retain their existing RF configuration. If the AirMatch updates are changed from the default **enabled** setting to **disabled**, the Mobility Master continues to receive RF updates from the APs but Mobility Master does not execute any channel or EIRP changes.

---

The AirMatch **disabled** setting is different from the ARM **disable** or **maintain** setting on a standalone controller. The ARM **disable** setting changes the AP radio's channel and EIRP values back to the default values specified in the AP radio's 802.11a and 802.11g radio profiles. The ARM **maintain** setting freezes the radio's current channel and EIRP settings. In contrast, if you use AirMatch in a Mobility Master/Managed Device topology, AirMatch's **disabled** option simply means the centralized algorithm will stop selecting a new channel, bandwidth, or EIRP setting; the network operator still can override the previous settings assigned by AirMatch with static channel or EIRP values, and the AP radio can continue to voluntarily change channels to avoid radar interference or high noise levels.

---



You can use the WebUI or command-line interface to define the most commonly used AirMatch configuration settings, but some advanced AirMatch settings are only available via the command-line interface.

### In the WebUI

To hold the existing AirMatch RF configuration and disable future updates in ArubaOS 8.0.1 or later:

1. In the **Mobility Master** node hierarchy, navigate to **Configuration > Services > AirMatch**.
2. Unselect the **Automatically deploy RF plan** checkbox.
3. Click **Submit**.
4. Select **Pending Changes**.
5. In the **Pending Changes** window, select the check box and click **Deploy changes**.

To change the time of the daily AirMatch RF updates:

1. In the **Mobility Master** node hierarchy, navigate to **Configuration > Services > AirMatch**.
2. In the **Activation Time** field, enter a number from 0-23 to specify an update hour (in 24-hour format).
3. Click **Submit**.
4. Select **Pending Changes**.
5. In the **Pending Changes** window, select the check box and click **Deploy changes**.



---

In ArubaOS 8.0.0, the AirMatch WebUI was located on the **Configuration > Services > More > AirMatch** page of the ArubaOS WebUI.

---

### In the CLI

To hold the existing AirMatch RF configuration :

```
(host) [mynode] (config) #airmatch profile schedule disable
```

To change the time of the daily AirMatch RF updates from the default 5 AM to 2 AM:

```
(host) [mynode] (config) #airmatch profile deploy-hour 2
```

Use the **quality-threshold** parameter to change the percentage of channel quality improvement that will trigger a scheduled AirMatch RF update. If a proposed channel change will not produce an improvement that meets or exceeds this threshold, AirMatch will not trigger a channel change.

```
(host) [mynode] (config) #airmatch profile quality-threshold <quality-threshold>
```

Use the Mobility Master command-line interface to manually initiate AirMatch RF computations and solution deployment instead of waiting for the next scheduled update period. Access the command-line interface in enable mode and issue the following command:

```
(host) [mynode] #airmatch runnow full
```

The **airmatch ap freeze** command deploys the specified channel and EIRP values to a radio immediately, then freezes those values, regardless of whether the AirMatch RF planning feature is set to **enable** or **disable** mode. A radio set with the **airmatch ap freeze** command uses a static radio configuration until those settings get explicitly canceled with the **airmatch ap unfreeze** command. This command can be used to freeze either the channel or the EIRP value, or both values. For example, you can freeze the channel on an AP radio, while allowing the EIRP values to be updated by AirMatch.

```
(host) [mynode] (config) # airmatch ap freeze {ip-addr <ip-addr>}|{ip6-addr <ip6-addr>}|{ap-name <ap-name>}|{ap-group <ap-group>}|{all-aps} {band <band>}|{channel <channel>}|{eirp <eirp>}|{lms {lms-ip <lms-ip>}|{lms-ipv6 <lms-ipv6>}}
```

Unfreezing a radio configuration with the **airmatch ap unfreeze** command does not mean that there will automatically be an immediate change in the radio's channel and EIRP values. It does, however, mean that the AirMatch algorithm can assign a new set of values at the next update.

```
(host) [mynode] (config) # airmatch ap unfreeze {ip-addr <ip-addr>}|{ip6-addr <ip6-addr>}|{ap-name <ap-name>}|{ap-group <ap-group>}|{all-aps} band <band> {channel <channel>}|{eirp <eirp>}|{lms {lms-ip <lms-ip>}|{lms-ipv6 <lms-ipv6>}}
```

By default, each AP in a Mobility Master deployment measures its RF environment for a five minute duration, every 30 minutes by default. Mobility Master uses this information to compute an optimal solution, then deploys the latest RF plan by sending updated settings to the APs. Use the **ap system profile** command to modify these default report intervals, or to disable AirMatch reports to the APs.

```
(host) [mynode] (config) #ap system-profile <profile>
    airmatch-measure-duration <airmatch-measure-duration>
    airmatch-report-enabled
    airmatch-report-period <airmatch-report-period>
```

## Configuring ClientMatch

Use the following procedures to disable or reenable ClientMatch, and upload a Rules-Based ClientMatch (RCBM) update package.

### Enabling and Disabling ClientMatch

ClientMatch is enabled by default. The procedure to disable and reenable ClientMatch varies, depending upon whether your deployment consists of multiple managed devices managed by a Mobility Master, or whether your APs are all associated to a stand-alone controller.

### Mobility Master Deployments

ClientMatch is enabled and disabled in the AP group's 2.4 GHz and 5 GHz radio settings.

1. In the **Managed Network** node hierarchy, navigate to the **Configuration > AP Groups** page.
2. Select the name of an AP group from the **AP Groups** table.

3. Click the **Radio** tab below the **AP Groups** table to display the AP radio settings.
4. Expand the **Client Control** section.
5. Click the **Client-Match** drop-down lists for the 2.4 GHz and 5 GHz radios to **enable** or **disable** ClientMatch for these radios.
6. Modify the desired settings, and then click **Submit**.
7. Click **Pending Changes**.
8. In the **Pending Changes** window, select the check box and click **Deploy Changes**.

For more information on managing 2.4 GHz and 5 GHz radio settings, see [2.4 Ghz and 5 Ghz Radio RF Management on page 530](#).

## Stand-alone Controller Deployments

For stand-alone controllers that do not have any associated managed devices, the ClientMatch feature is enabled and disabled in the AP's Adaptive Radio Management (ARM) profile, as described in [Configuring ARM Profiles on page 453](#). Although default ClientMatch settings are recommended for most users, advanced ClientMatch settings can be configured using **rf arm-profile** commands in the command-line interface.

## Uploading a Custom Client-Match Rule Update Package

Use the WebUI or command line interface to upload a custom update file of ClientMatch rules to the **/flash/config** folder on Mobility Master. This feature is not available for stand-alone controller deployments.

### In the WebUI

To upload a ClientMatch rule update package in ArubaOS 8.0.1 or later:

1. In the **Mobility Master** node hierarchy, navigate to **Diagnostics > Technical Support > Client Match Rules**.
2. Click **Upload File**, and then select a file to upload.
3. Click **Submit**.
4. Click **Pending Changes**.
5. In the **Pending Changes** window, select the check box and click **Deploy Changes**.

---

ArubaOS 8.0.1 introduces a new WebUI page to upload a custom Client-Match rule update package. Starting with ArubaOS 8.0.1, you must upload a ClientMatch rule update package via the **Diagnostics > Technical Support > Client Match Rules** page of the Mobility Master WebUI. This is a change from ArubaOS 8.0.0, where ClientMatch rule packages are uploaded via the **Configuration > Services > More > ClientMatch** page.

---



### In the CLI

```
(host) [mynode] (config) #copy tftp: <tftphost> <filename> flash: <destname>
(host) [mynode] (config) #copy ftp: <ftphost> <user> <password> flash: <destname>
(host) [mynode] (config) #copy scp: <scphost> <username> <password> flash: <destname>
```

## RF Management for Stand-alone Controller Deployments

Aruba's Adaptive Radio Management (ARM) technology maximizes WLAN performance even in the highest traffic networks by dynamically and intelligently choosing the best 802.11 channel and transmit power for each Aruba AP in its current RF environment.

Aruba's ARM technology solves wireless networking challenges for stand-alone controllers in a large network deployment, dense deployment, or a network that must support VoIP or mobile users. Deployments with

dozens of users per access point can cause network contention and interference, but ARM dynamically monitors and adjusts the network to ensure that all users are allowed ready access.

ARM continually monitors and adjusts radio resources to provide optimal network performance for APs associated to a stand-alone controller. Automatic power control can adjust AP power settings if adjacent APs are added, removed, or moved to a new location within the network, minimizing interference with other WLAN networks. ARM adjusts only the affected APs, so the entire network does not require systemic changes.

This section describes the following features:

- [Adaptive Radio Management \(ARM\) Monitoring and Management on page 447](#)
- [Traffic Shaping on page 450](#)

## Adaptive Radio Management (ARM) Monitoring and Management

When ARM is enabled, the Aruba AP dynamically scans all 802.11 channels in its regulatory domain at regular intervals and will report everything it sees to the controller on each channel it scans (by default, 802.11n-capable APs scan channels in all regulatory domains). This includes, but is not limited to, data regarding WLAN coverage, interference, and intrusion detection. You can retrieve this information from the controller to get a quick health check of your WLAN deployment without having to walk around every part of a building with a network analyzer. For additional information on the individual matrix gathered on the AP's current assigned RF channel, see [ARM Coverage and Interference Metrics on page 449](#).

### Maintaining Channel Quality

Hybrid APs and Spectrum Monitors determine channel quality by measuring channel noise, non-Wi-Fi (interferer) utilization and duty-cycles, and certain types of retries. Regular APs using ARM derive channel quality values by measuring the noise floor for both 802.11 and non-802.11 noise on that channel.

The ARM algorithm is based on what the individual AP hears, so each AP on your WLAN can effectively “self heal” by compensating for changing scenarios like a broken antenna or blocked signals from neighboring APs. Additionally, ARM periodically collects information about neighboring APs to help each AP better adapt to its own changing environment.

### Configuring ARM Scanning

The default ARM scanning interval is determined by the **scan-interval** parameter in the ARM profile. If the AP does not have any associated clients (or if most of its clients are inactive), ARM will dynamically readjust this default scan interval, allowing the AP to obtain better information about its RF neighborhood by scanning non-home channels more frequently. If an AP attempts to scan a non-home channel but is unsuccessful, the AP will make additional attempts to rescan that channel before skipping it and continuing on to other channels.

The **Over the Air Updates** feature allows an AP to get information about its RF environment from its neighbors, even if the AP cannot scan. If you enable this feature, when an AP on the network scans a foreign (non-home) channel, it sends an Over-the-Air (OTA) update in an 802.11 management frame that contains information about that AP's home channel, the current transmission EIRP value of the home channel, and one-hop neighbors seen by that AP.

If ARM reports a high noise floor on a channel within a 40 MHz channel pair or 80 MHz channel set, ARM performs an additional 20 MHz scan on each channel within that channel pair or set, to determine the actual noise floor of each affected channel. This allows ARM to avoid assigning the overused channel, while still allowing channel assignments to the other unaffected channels in that channel pair or set.

### Understanding ARM Application Awareness

Aruba APs keep a count of the number of data bytes transmitted and received by their radios to calculate the traffic load. When a WLAN gets very busy and traffic exceeds a predefined threshold, load-aware ARM dynamically adjusts scanning behavior to maintain uninterrupted data transfer on heavily loaded systems.

ARM-enabled APs will resume their complete monitoring scans when the traffic has dropped to normal levels. You can also define a firewall policy that pauses ARM scanning when the AP detects critically important or latency-sensitive traffic from a specified host or network.

ARM's band steering feature encourages dual-band capable clients to stay on the 5 GHz band on dual-band APs. This frees up resources on the 2.4 GHz band for single-band clients like VoIP phones.

The ARM "Mode Aware" option is a useful feature for single radio, dual-band WLAN networks with high density AP deployments. If there is too much AP coverage, those APs can cause interference and negatively impact your network. Mode aware ARM can turn APs into Air Monitors if necessary, then turn those Air Monitors back into APs when they detect gaps in coverage. Note that an Air Monitor will not turn back into an AP if it detects client traffic (or client traffic increases), but will change to an AP only if it detects coverage holes.

### Using Multi-Band ARM for 802.11a/802.11g Traffic

It is recommended that you use the **multi-band** ARM assignment and **Mode Aware** ARM feature for single-radio APs in networks with traffic in the 802.11 a and 802.11 g bands. This feature allows a single-radio AP to dynamically change its radio bands based on current coverage on the configured band. This feature is enabled via the AP's ARM profile.

When you first provision a single-radio AP, it initially operates in the radio band specified in its AP system profile. If the AP finds adequate coverage on multiple channels in its current band of operation, the **mode-aware** feature allows the AP to temporarily turn itself off and become an AP Air Monitor (APM). In AP Monitor mode, the AP scans all channels across both bands to verify that each channel meets or exceeds its required level of acceptable radio coverage (as defined by the in the ARM profile).

If the AP Monitor detects that a channel on the 802.11 g band does not have adequate radio coverage, it will convert back to an AP on that 802.11 channel. If the 802.11 g band is adequately covered, the AP Monitor will next check the 802.11 a band. If a channel on the 802.11 a band lacks coverage, the AP Monitor will convert back to an AP on that 802.11 a channel.

### 80MHz Dynamic Bandwidth Switch

If an AP radio uses an 80 MHz channel, the radio only sends out frames when the entire 80 MHz channel is clear, even if the AP is sending only a 20 MHz management frame or 40 MHz data frame. As a result, throughput on the selected 80 MHz channel can be negatively impacted if interference occurs on both 20 MHz channels of the secondary 40 MHz channel.

The ARM dynamic bandwidth switch feature allows ARM to detect the 20 MHz interferers in this situation and potentially move the AP radio to another 80 MHz channel, or change the AP transmissions to 40 MHz and use the primary 40 MHz channel instead.

When this feature is enabled, ARM starts a dynamic bandwidth switch observation window if load-aware scan rejects increase, *and* the clear channel assignment IBSS percentage (the percentage of channel traffic sent from that AP radio) drops below the value defined by the **dynamic-bw-cca-ibss-thresh** parameter.

If an observation window opens, and the clear channel assignment interference threshold exceeds the value defined by the **dynamic-bw-cca- intf-thresh** parameter, and the number of failed beacons from the radio exceeds the threshold defined by the **dynamic-bw-beacon- failed-thresh** parameter during that observation period, ARM will move the AP to another available 80 MHz channel with the minimum interference index. If no other 80 MHz channel is available, ARM downgrades the radio bandwidth to 40 MHz.



---

This feature is configured using the **rf arm-profile** command in the command-line interface. For more information refer to the *ArubaOS CLI Reference Guide*.

---



## ARM Coverage and Interference Metrics

ARM computes coverage and interference metrics for each valid channel and chooses the best performing channel and transmit power settings for each AP's RF environment. Each AP gathers other metrics on their ARM-assigned channel to provide a snapshot of the current RF health state.

The following two metrics help the AP decide which channel and transmit power setting is best.

- **Coverage Index:** The AP uses this metric to measure RF coverage. The coverage index is calculated as  $x/y$ , where "x" is the AP's weighted calculation of the Signal-to-Noise Ratio (SNR) on all valid APs on a specified 802.11 channel, and "y" is the weighted calculation of the Aruba AP's SNR the neighboring APs see on that channel.

To view these values for an AP in your current WLAN environment, issue the CLI command **show ap arm rf-summary ap-name <ap-name>**, where **<ap-name>** is the name of an AP for which you want to view information.

- **Interference Index:** The AP uses this metric to measure co-channel and adjacent channel interference. The Interference Index is calculated as  $a/b/c/d$ , where:
  - Metric value "a" is the channel interference the AP sees on its selected channel.
  - Metric value "b" is the interference the AP sees on the adjacent channel.
  - Metric value "c" is the channel interference the AP's neighbors see on the selected channel.
  - Metric value "d" is the interference the AP's neighbors see on the adjacent channel.

To manually calculate the total Interference Index for a channel, issue the CLI command **show ap arm rf-summary ap-name <ap-name>**, then add the values  $a+b+c+d$ .

Each AP also gathers the following additional metrics, which can provide a snapshot of the current RF health state. View these values for each AP using the CLI command **show ap arm rf-summary ip-addr <ap ip address>**.

- Amount of Retry frames (measured in %)
- Amount of Low-speed frames (measured in %)
- Amount of Non-unicast frames (measured in %)
- Amount of Fragmented frames (measured in %)
- Amount of Bandwidth seen on the channel (measured in kbps)
- Amount of PHY errors seen on the channel (measured in %)
- Amount of MAC errors seen on the channel (measured in %)
- Noise floor value for the specified AP

## Cellular Handoff Assist

Some dual-network-capable devices, such as mobile phones, prefer to connect to Wi-Fi networks and may remain associated to a Wi-Fi network even when they experience poor performance at the edge of the Wi-Fi coverage area. When both the ClientMatch and the cellular handoff assist features are enabled, the cellular handoff assist feature can help a dual-mode, 3G/4G-capable Wi-Fi device, such as an iPhone, iPad, or Android client at the end of a Wi-Fi network, switch from Wi-Fi to an alternate 3G/4G radio that provides better network access. This feature is supported by iOS and Android devices only.

This feature is enabled via the Virtual AP profile for an AP or AP group. For more information on Virtual AP profiles and other WLAN configuration settings, see [Basic WLAN Configuration Workflow on page 404](#)

## Traffic Shaping

In a mixed-client network, it is possible for slower clients to bring down the performance of the whole network. To solve this problem and ensure fair access to all clients independent of their WLAN or IP stack capabilities, an AP can implement the traffic shaping feature. This feature has the following three options:

- **default-access:** Traffic shaping is disabled, and client performance is dependent on MAC contention resolution. This is the default traffic shaping setting.
- **fair-access:** Each client gets the same airtime, regardless of client capability and capacity. This option is useful in environments like a training facility or exam hall, where a mix of 802.11 a/g, 802.11g and 802.11n clients need equal to network resources, regardless of their capabilities.
- **preferred-access:** High-throughput (802.11 n) clients do not get penalized because of slower 802.11 a/g or 802.11 b transmissions that take more air time due to lower rates. Similarly, faster 802.11 a/g clients get more access than 802.11 b clients.

With this feature, an AP keeps track of all BSSIDs active on a radio, all clients connected to the BSSID, and 802.11 a/g, 802.11 b, or 802.11 n capabilities of each client. During every sampling period, airtime is allocated to each client, giving it the opportunity to receive traffic. The specific amount of airtime given to an individual client is determined by the following factors:

- Client capabilities (802.11 a/g, 802.11 b or 802.11 n).
- Amount of time the client spent receiving data during the last sampling period.
- Number of active clients in the last sampling period.
- Activity of the current client in the last sampling period.

The **bw-alloc** parameter of a traffic management profile allows you to set a minimum bandwidth to be allocated to a virtual AP profile when there is congestion on the wireless network. You must set traffic shaping to **fair-access** to use this bandwidth allocation value for an individual virtual AP.

Traffic shaping is configured in an traffic management profile. You can use the CLI or WebUI to enable and configure traffic shaping.

### In the WebUI

To configure traffic shaping via the WebUI:

1. In the **Mobility Master** node hierarchy, navigate to **Configuration > System > Profiles**.
2. Select **QoS** from the **All Profiles** list to expand the **QoS** section.
3. Select the **Traffic management** profile.
4. In the **Profiles Details** window, select the name of the traffic management profile for which you want to configure traffic shaping. If you do not have any traffic management profiles configured, click **+** and enter a name for a new profile.

The following table describes configuration settings available in the **General** and **Advanced** sections of the traffic management profile.

**Table 87: Traffic Management Profile Parameters**

Parameter	Description
<b>General Settings</b>	
Station Shaping Policy	<p>Define Station Shaping Policy This feature has the following three options:</p> <ul style="list-style-type: none"> <li>• <b>default-access:</b> Traffic shaping is disabled, and client performance is dependent on MAC contention resolution. This is the default traffic shaping setting.</li> <li>• <b>fair-access:</b> Each client gets the same airtime, regardless of client capability and capacity. This option is useful in environments like a training facility or exam hall, where a mix of 802.11a/g, 802.11g, and 802.11n clients need equal to network resources, regardless of their capabilities. The bw-alloc parameter of a traffic management profile allows you to set a minimum bandwidth to be allocated to a virtual AP profile when there is congestion on the wireless network. You must set traffic shaping to fair-access to use this bandwidth allocation value for an individual virtual AP.</li> <li>• <b>preferred-access:</b> High-throughput (802.11n) clients do not get penalized because of slower 802.11a/g or 802.11b transmissions that take more air time due to lower rates. Similarly, faster 802.11a/g clients get more access than 802.11b clients.</li> </ul>
<b>Advanced Settings</b>	
Proportional BW Allocation	<p>You can allocate a maximum bandwidth, as a percentage of available bandwidth to a virtual AP (VAP).</p> <p>To assign a percentage of bandwidth to a virtual AP:</p> <ol style="list-style-type: none"> <li>1. Click + in the <b>Proportional BW Allocation</b> table.</li> <li>2. Select the VAP profile to which you would like to allocate a bandwidth share from the <b>virtual_ap</b> drop-down list.</li> <li>3. Specify the percentage of bandwidth to be allocated to the VAP in the <b>share</b> field.</li> <li>4. Click the <b>hard_limit</b> drop-down list and select the mode for restricting the bandwidth for the VAP. Select the <b>soft</b> limit check box if you want to restrict the bandwidth for this VAP when there is a congestion on the wireless network. If you do want to restrict the bandwidth even when here there is congestion, select the <b>hard</b> limit option.</li> <li>5. Click <b>OK</b>.</li> <li>6. Repeat steps 1-5 to assign any remaining bandwidth to additional VAPs, if desired.</li> </ol> <p>To remove a VAP from the list of VAPs with allocated bandwidth, select the VAP from the <b>Proportional BW Allocation</b> table and click <b>Delete</b>.</p>
Report Interval	<p>Number of minutes between bandwidth usage reports.</p> <p>Range: 1-99 minutes</p> <p>Default value is 5 minutes.</p>

7. Click **Save**.
8. Click **Pending Changes**.
9. In the **Pending Changes** window, select the check box and click **Deploy Changes**.

### In the CLI

To enable and configure traffic shaping via the command-line interface, access the CLI in config mode and issue the following commands:

```
(host) [mynose] (config) #wlan traffic-management-profile <profile> shaping-policy default-access|fair-access|preferred-access
```

Use the following commands to apply an 802.11a or 802.11g traffic management profile to an AP group or an individual AP.

```
(host) [mynode] (config) #ap-group <name> dot11a-traffic-mgmt-profile|dot11g-traffic-mgmt-profile <profile>
```

## ARM Coverage and Interference Metrics

ARM computes coverage and interference metrics for each valid channel, and chooses the best performing channel and transmit power settings for each AP's RF environment. Each AP gathers other metrics on their ARM-assigned channel to provide a snapshot of the current RF health state.

The following two metrics help the AP decide which channel and transmit power setting is best:

- **Coverage Index:** The AP uses this metric to measure RF coverage. The coverage index is calculated as  $x/y$ , where "x" is the AP's weighted calculation of the Signal-to-Noise Ratio (SNR) on all valid APs on a specified 802.11 channel, and "y" is the weighted calculation of the Aruba AP's SNR the neighboring APs see on that channel.

To view these values for an AP in your current WLAN environment, issue the CLI command **show ap arm rf-summary ap-name <ap-name>**, where **<ap-name>** is the name of an AP for which you want to view information.

- **Interference Index:** The AP uses this metric to measure co-channel and adjacent channel interference. The Interference Index is calculated as  $a/b/c/d$ , where:
  - Metric value "a" is the channel interference the AP sees on its selected channel.
  - Metric value "b" is the interference the AP sees on the adjacent channel.
  - Metric value "c" is the channel interference the AP's neighbors see on the selected channel.
  - Metric value "d" is the interference the AP's neighbors see on the adjacent channel.

To manually calculate the total Interference Index for a channel, issue the CLI command **show ap arm rf-summary ap-name <ap-name>**, then add the values  $a+b+c+d$ .

Each AP also gathers the following additional metrics, which can provide a snapshot of the current RF health state. View these values for each AP using the CLI command **show ap arm rf-summary ip-addr <ap ip address>**.

- Amount of Retry frames (measured in %)
- Amount of Low-speed frames (measured in %)
- Amount of Non-unicast frames (measured in %)
- Amount of Fragmented frames (measured in %)
- Amount of Bandwidth seen on the channel (measured in kbps)
- Amount of PHY errors seen on the channel (measured in %)
- Amount of MAC errors seen on the channel (measured in %)
- Noise floor value for the specified AP

The following enhancements are introduced in ArubaOS 8.0 to resolve issues that occur with the distributed channel/power algorithm:

- **Push random channel assignments to APs:** To support the random channel assignment feature, set the **Assignment** parameter in the ARM profile to **maintain**. Once this is done, random channels are pushed from the managed device STM/SAPM to APs that belong to a specific ap-group. This helps in replacing the dynamic channel change solution in a high density environment, thereby overcoming the issue with convergence. Random channel assignment helps in certain customer deployments where administrators want to control channels assigned and also for initial channel assignment to seed ARM channel computation.

- **Reduce interference channel change:** To reduce the number of interference channel changes and to configure the weight of interfering APs when calculating the interference index, the **interfering-ap-weight** parameter is introduced in the **rf-arm-profile** command. Before this enhancement was introduced, the value of the interfering AP (uncontrollable AP) was similar to the valid AP (controllable AP).

## Configuring ARM Profiles

ARM profile settings are divided into two categories: **General**, **Scanning** and **Advanced**. The general ARM settings include general configuration parameters such as channel and power assignments and minimum and maximum allowed EIRP values.



---

Most network environments do not require any changes to the **Scanning** or **Advanced** categories of ARM configuration settings. If, however, your network supports a large amount of VoIP or Video traffic, or if you have unusually high security requirements you may want to manually adjust the basic ARM thresholds.

---

### Default Profiles

When you create a new AP group and modify any of the ARM settings for that group, ArubaOS creates a unique profile for that AP group. The settings in these default profiles may vary, depending upon the radio type. The default ARM profile for a 2.4 GHz radio is Default-g, and the default profile for a 5 GHz radio is Default-a.

### Manually Configuring an ARM Profile

The range of RF settings that can be assigned to an the AP is defined in the 2.4 GHz and 5 GHz radio profiles. You can access these settings on the Mobility Master WebUI by selecting the configuration for the managed device from the configuration hierarchy, then navigating to the **Configuration > AP Groups > Radio** page. However, advanced ARM settings can be edited using the WebUI or command-line interface.



---

The ARM profile also includes advanced ClientMatch settings that can be configured through the command-line interface only. The default values for these settings are recommended for most users, and caution should be used when changing them to a non-default value. For complete details on all ClientMatch configuration settings, refer to the *ArubaOS CLI Reference Guide*.

---

### In the WebUI

To edit an ARM profile via the WebUI:

1. In the **Mobility Master** node hierarchy, navigate to **Configuration > System > Profiles**.
2. Select **RF Management** from the **All Profiles** list, and then click **Adaptive Radio Management (ARM)**.
3. Select the ARM profile you want to edit, or create a new profile by clicking **+** and entering a name for the new profile in the **Profile Name** field. The ARM profile settings are divided into three sections, **General**, **Scanning** and **Advanced**. The profile parameters in each section are described in [Table 88](#).

**Table 88: ARM Profile Configuration Parameters**

Parameter	Description	Default
<b>Basic</b>		
Assignment	<p>Activates one of four ARM channel/power assignment modes.</p> <ul style="list-style-type: none"> <li>● <b>disable:</b> Disables ARM calibration and reverts APs back to default channel and power settings specified by the AP's radio profile.</li> <li>● <b>maintain:</b> APs maintain their current channel and power settings. This setting can be used to maintain AP channel and power levels after ARM has initially selected the best settings.</li> <li>● <b>multi-band:</b> For single-radio APs, this value computes ARM assignments for both 5 GHz (802.11a) and 2.4 GHz (802.11b/g) frequency bands.</li> <li>● <b>single-band:</b> For dual-radio APs, this value enables APs to change transmit power and channels within their same frequency band, and to adapt to changing channel conditions.</li> </ul>	single-band
Allowed bands for 40MHz channels	The specified setting allows ARM to determine if 40 MHz mode of operation is allowed on the 5 GHz or 2.4 GHz frequency band only, on both frequency bands, or on neither frequency band.	a-only
80MHz support	If enabled, this feature allows ARM to assign 80 MHz channels on APs that support VHT.	enabled
Max Tx EIRP	<p>Maximum effective isotropic radiated power (EIRP) from 3 to 33 dBm in 3 dBm increments. You may also specify a special value of 127 dBm for regulatory maximum. Higher power level settings may be constrained by local regulatory requirements and AP capabilities. In the event that an AP is configured for a <b>Max Tx EIRP</b> setting it cannot support, this value will be reduced to the highest supported power setting.</p> <p><b>NOTE:</b> Power settings will not change if the <b>Assignment</b> option is set to <b>disabled</b> or <b>maintain</b>.</p>	<ul style="list-style-type: none"> <li>● default-a: 18 dBm</li> <li>● default-g: 9 dBm</li> </ul>
Min Tx EIRP	<p>Minimum effective isotropic radiated power (EIRP) from 3 to 33 dBm in 3 dBm increments. You may also specify a special value of 127 dBm for regulatory maximum to disable power adjustments for environments such as outdoor mesh links. Note that power settings will not change if the <b>Assignment</b> option is set to <b>disabled</b> or <b>maintain</b>. Higher power level settings may be constrained by local regulatory requirements and AP capabilities. In the event that an AP is configured for a <b>Min Tx EIRP</b> setting it cannot support, this value will be reduced to the highest supported power setting.</p>	<ul style="list-style-type: none"> <li>● default-a: 12 dBm</li> <li>● default-g: 6 dBm</li> </ul>

**Table 88: ARM Profile Configuration Parameters**

Parameter	Description	Default
	Consider configuring a <b>Min Tx Power</b> setting higher than the default value if most of your APs are placed on the ceiling. APs on a ceiling often have good line of sight between them, which will cause ARM to decrease their power to prevent interference. However, if the wireless clients down on the floor do not have such a clear line back to the AP, you could end up with coverage gaps.	
ClientMatch	<p>The ClientMatch feature helps optimize network resources by balancing clients across channels, regardless of whether the AP or the managed device is responding to the wireless clients' probe requests.</p> <p>If enabled, the managed device compares whether an AP has more clients than its neighboring APs on other channels. If an AP's client load is at or over a predetermined threshold as compared to its immediate neighbors, or if a neighboring Aruba AP on another channel does not have any clients, load balancing will be enabled on that AP. This feature is enabled by default. For details, see <a href="#">ClientMatch Overview on page 441</a>.</p>	Enabled
<b>Scanning</b>		
Scanning	<p>The <b>Scanning</b> check box enables or disables AP scanning across multiple channels. This check box is selected by default. Do not disable scanning unless you want to disable ARM and manually configure AP channel and transmission power. Disabling this option also disables the following scanning features:</p> <ul style="list-style-type: none"> <li>● Multi Band Scan</li> <li>● Rogue AP Aware</li> <li>● Voip Aware Scan</li> <li>● Power Save Scan</li> </ul>	Enabled
Multi Band Scan	<p>If enabled, single radio channel APs scan for rogue APs across multiple channels. This option requires that <b>Scanning</b> is also enabled.</p> <p>(The <b>Multi Band Scan</b> option does not apply to APs that have two radios, as these devices already scan across multiple channels. If one of these dual-radio devices are assigned an ARM profile with Multi Band enabled, that device will ignore this setting.)</p>	Enabled
VoIP Aware Scan	<p>Aruba's VoIP Call Admission Control (CAC) prevents any single AP from becoming congested with voice calls. When you enable CAC, you should also enable <b>VoIP Aware Scan</b> in the ARM profile, so the AP will not attempt to scan a different channel if one of its clients has an active VoIP call. This option requires that <b>Scanning</b> is also enabled.</p>	Enabled

**Table 88: ARM Profile Configuration Parameters**

Parameter	Description	Default
Power Save Aware Scan	If enabled, the AP will not scan a different channel if it has one or more clients that is in power save mode.	Disabled
Video Aware Scan	As long as there is at least one video frame every 100 mSec the AP will reject an ARM scanning request. Note that for each radio interface, video frames must be defined in one of two ways: <ul style="list-style-type: none"> <li>Classify the frame as video traffic via a session ACL.</li> <li>Enable WMM on the WLAN's SSID profile and define a specific DSCP value as a video stream. Next, create a session ACL to tag the video traffic with the that DSCP value.</li> </ul>	Enabled
Scan Mode	By default, 802.11n-capable APs scan channels within all regulatory domains. To limit the AP scans to just the regulatory domain for that AP, click the <b>Scan Mode</b> drop-down list and select <b>reg-domain</b> .  <b>NOTE:</b> This setting does not apply to APs that do not support 802.11n; these APs will scan their regulatory domain only.	all-reg-domain
<b>Advanced</b>		
Client Aware	If the <b>Client Aware</b> option is enabled, the AP does not change channels if there is an active client associated to that AP. (Activity is defined by the <b>sta-inactivity-time</b> parameter in the IDS general profile. By default, a client is considered active if it has sent or received traffic within the last 60 seconds.)  If you disable <b>Client Aware</b> , the AP may change to a more optimal channel, but this change may also disrupt current client traffic.	Enabled
Rogue AP Aware	If you have enabled both the <b>Scanning</b> and <b>Rogue AP options</b> , Aruba APs may change channels to contain off-channel rogue APs with active clients. This security features allows APs to change channels even if the <b>Client Aware</b> setting is disabled.  This setting is disabled by default, and should only be enabled in high-security environments where security requirements are allowed to consume higher levels of network resources. You may prefer to receive Rogue AP alerts via SNMP traps or syslog events.	Disabled
Active Scan	When you enable <b>Active Scan</b> , an AP initiates active scanning via probe request. This option elicits more information from nearby APs, but also creates additional management traffic on the network. <b>Active Scan</b> is disabled by default, and should <i>not be enabled</i> except under the direct supervision of Aruba Support.	Disabled



**Table 88: ARM Profile Configuration Parameters**

Parameter	Description	Default
ARM Over the Air Updates	<p>The <b>ARM Over the Air Updates</b> option allows an AP to get information about its RF environment from its neighbors, even the AP cannot scan. If this feature is enabled, when an AP on the network scans a foreign (non-home) channel, it sends other APs an Over-the-Air (OTA) update in an 802.11 management frame that contains information about the scanning AP's home channel, the current transmission EIRP value of its home channel, and one-hop neighbors seen by that AP.</p> <p>Default: enabled</p>	Enabled
Ideal Coverage Index	<p>The Aruba coverage index metric is a weighted calculation based on the RF coverage for all Aruba APs and neighboring APs on a specified channel. The <b>Ideal Coverage Index</b> specifies the ideal coverage that an AP should try to achieve on its channel. The denser the AP deployment, the lower this value should be.</p> <p>Range: 2–20</p> <p>For additional information on how this the Coverage Index is calculated, see <a href="#">ARM Coverage and Interference Metrics on page 449</a></p>	<ul style="list-style-type: none"> <li>• default-a: 6</li> <li>• default-g: 6</li> </ul>
Acceptable Coverage Index	<p>For multi-band implementations, the <b>Acceptable Coverage Index</b> specifies the minimal coverage an AP it should achieve on its channel. The denser the AP deployment, the lower this value should be.</p> <p>Range: 1–6</p>	4
Free Channel Index	<p>The Aruba Interference index metric measures interference for a specified channel and its surrounding channels. This value is calculated and weighted for all APs on those channels (including 3rd-party APs).</p> <p>An AP will only move to a new channel if the new channel has a lower interference index value than the current channel. <b>Free Channel Index</b> specifies the required difference between the two interference index values before the AP moves to the new channel. The lower this value, the more likely it is that the AP will move to the new channel. The range of possible values is 10–40.</p> <p>For additional information on how this the Channel Index is calculated, see <a href="#">ARM Coverage and Interference Metrics on page 449</a></p>	<ul style="list-style-type: none"> <li>• default-a: 40</li> <li>• default-g: 25</li> </ul>
Interfering AP weight	<p>Weight of interfering APs in the interference index calculation.</p> <p>Range: 0-100</p>	25
Backoff Time	<p>After an AP changes channel or power settings, it waits for the backoff time interval before it asks for a new channel/power setting.</p> <p>Range: 120–3600 seconds.</p>	240 sec

**Table 88: ARM Profile Configuration Parameters**

Parameter	Description	Default
Error Rate Threshold	The minimum percentage of PHY errors and MAC errors in the channel that will trigger a channel change.	<ul style="list-style-type: none"> <li>• default-a: 70%</li> <li>• default-g: 70%</li> </ul>
Error Rate Wait Time	Minimum time in seconds the error rate has to exceed the Error Rate Threshold before it triggers a channel change.	<ul style="list-style-type: none"> <li>• default-a: 90 sec</li> <li>• default-g: 90 sec</li> </ul>
Channel Quality Aware Arm	If this feature is enabled, ARM changes are based upon an internally calculated channel quality metric. When this feature is disabled, ARM initiates channel changes based on thresholds defined in this profile, and chooses the channel based on the calculated interference index value. Default: Disabled	Disabled
Channel Quality Threshold	Channel quality percentage below which ARM initiates a channel change. Range: 0-100%	70%
Channel Quality Wait Time	If channel quality is below the specified channel quality threshold for this wait time period, ARM initiates a channel change. Range:1-3600 seconds	120 seconds
Minimum Scan Time	Minimum number of times a channel must be scanned before it is considered for assignment. Range: 0–2,147,483,647 scans. It is recommended to use a <b>Minimum Scan Time</b> between 1–20 scans.	8 scans
Load Aware Scan Threshold	Load aware ARM preserves network resources during periods of high traffic by temporarily halting ARM scanning if the load for the AP gets too high.  The <b>Load Aware Scan Threshold</b> is the traffic throughput level an AP must reach before it stops scanning.  Range: 0–20,000,000 bytes/second. (Specify 0 to disable this feature.)	1250000 Bps
Mode Aware ARM	If enabled, ARM will turn APs into Air Monitors (AMs) if it detects higher coverage levels than necessary. This helps avoid higher levels of interference on the WLAN. Although this setting is disabled by default, you may want to enable this feature if your APs are deployed in close proximity (less than 60 feet apart).  Mode aware ARM turns Air Monitors back into APs when they detect gaps in coverage. Note that an Air Monitor will not turn back into an AP if it detects client traffic (or client traffic increases), but will change to an AP only if it detects coverage holes.	Disabled

## In the CLI

To create a new ARM profile or modify an existing profile via the command-line interface, access the CLI in config mode and issue the following command:

```
(host) [mynode] (config) #rf arm-profile <profile>
```

## Dynamic Bandwidth Switch

ARM's dynamic bandwidth switch feature provides capability for ARM to detect the 20 MHz interferer by reading the Clear Channel Assessment (CCA) statistics and other radio statistics. Once the signatures are detected, ARM moves to another 80 MHz channel or downgrades to 40 MHz. This feature only works when **dynamic-bw** parameter is enabled and ARM is set to use 80 MHz assignment.



---

If ARM decides to downgrade the bandwidth to 40 MHz, then it will upgrade back to 80 MHz after the clear time based on the volume of the traffic.

---

## Enabling Dynamic Bandwidth Switch

Use the following procedures to enable or disable dynamic bandwidth switch using command-line interfaces.

### In the CLI

Use the following commands to enable and set dynamic bandwidth switch:

```
(host) [mynode] (config) #rf arm-profile default
(host) [mynode] (Adaptive Radio Management (ARM) profile "default") #dynamic-bw
(host) [mynode] (Adaptive Radio Management (ARM) profile "default") #dynamic-bw-beacon-failed-
thresh
(host) [mynode] (Adaptive Radio Management (ARM) profile "default") #dynamic-bw-cca-ibss-
thresh
(host) [mynode] (Adaptive Radio Management (ARM) profile "default") #dynamic-bw-cca-intf-
thresh
(host) [mynode] (Adaptive Radio Management (ARM) profile "default") #dynamic-bw-clear-time
(host) [mynode] (Adaptive Radio Management (ARM) profile "default") #dynamic-bw-wait-time
```

## Troubleshooting ARM

If ARM is enabled but does not seem to be working properly, try some of the troubleshooting tips below.

### Too many APs on the Same Channel

If many APs are selecting the same RF channel, there may be excessive interference on the other valid 802.11 channels. Issue the CLI commands **show ap arm rf-summary ap-name <ap-name>** or **show ap arm rf-summary ip-addr <ap ip address>** and calculate the Interference index (*intf\_idx*) for all the valid channels.

An AP will only move to a new channel if the new channel has a lower interference index value than the current channel. The ARM Free Channel Index parameter specifies the required difference between two interference index values. If this value is set too high, the AP will not switch channels, even if the interference is slightly lower on another channel. Lower the Free Channel Index to improve the likelihood that the AP will switch to a better channel.

### Wireless Clients Report a Low Signal Level

If APs detect strong signals from other APs on the same channel, they may decrease their power levels accordingly. Issue the CLI commands **show ap arm rf-summary ap-name <ap-name>** or **show ap arm rf-summary ip-addr <ap ip address>**.

for all APs and check their current coverage index (*cov-idx*). If the AP's coverage index is at or higher than the configured coverage index value, then the APs have correctly chosen the transmit power setting. To manually increase the minimum power level for the APs using a specific ARM profile, define a higher minimum value with the command **rf arm-profile <profile> min-tx-power <dBm>**.

If wireless clients still report that they see low signal levels for the APs, check that the AP's antennas are correctly connected to the AP and correctly placed according to the manufacturer's installation guide.

### **Transmission Power Levels Change Too Often**

Frequent changes in transmission power levels can indicate an unstable RF environment, but can also reflect incorrect ARM or AP settings. To slow down the frequency at which the APs change their transmit power, set the ARM backoff time to a higher value.

### **APs Detect Errors but Do Not Change Channels**

First, ensure that ARM error checking is enabled. The ARM Error Rate Threshold should be set to a percentage higher than zero. The suggested configuration value for the ARM Error Rate Threshold is 30–50%.

### **APs Don't Change Channels Due to Channel Noise**

APs will only change channels due to interference if you enable ARM noise checking. Check to verify that the ARM Noise Threshold is set to a value higher than 0 dBm. The suggested setting for this threshold is 75 dBm.

The ArubaOS Wireless Intrusion Prevention (WIP) features and configurations are discussed in this chapter. WIP offers a wide selection of intrusion detection and protection features to protect the network against wireless threats. The WIP configuration is done on Mobility Master in the network.

These features do not require an RFprotect license:

- Rogue AP classification techniques other than AP classification rules
- Rogue containment
- Wired containment
- Wireless containment without Tarpit

For details on commands refer to the *ArubaOS CLI Reference Guide*.

This chapter contains the following sections:

- [Working with the Reusable Wizard on page 461](#)
- [Monitoring the Security Dashboard on page 462](#)
- [Detecting Rogue APs on page 463](#)
- [Working with Intrusion Detection on page 466](#)
- [Configuring Intrusion Protection on page 478](#)
- [Configuring the WLAN Management System \(WMS\) on page 481](#)
- [Understanding Client Blacklisting on page 487](#)
- [Working with WIP Advanced Features on page 490](#)
- [Configuring TotalWatch on page 490](#)
- [Administering TotalWatch on page 493](#)
- [Tarpit Shielding Overview on page 494](#)
- [Configuring Tarpit Shielding on page 494](#)

## Working with the Reusable Wizard

The WebUI's reusable, intuitive, user-friendly Wizard provides steps to enable, define, or change

- Integrated vs Overlay WLAN/WIP options
- Detection features for attacks against infrastructure
- Detection features for attacks against WLAN clients
- Protection features for attacks against infrastructure
- Protection features for WLAN clients

## Understanding Wizard Intrusion Detection

Apply the intrusion detection mechanisms for detecting attacks against your infrastructure and clients. You can either set the detection level to automatically enable the appropriate detection mechanisms or customize the settings for infrastructure and client attacks. Use the slider to select one of the detection levels for the infrastructure and clients:

- High—Enables all the detection mechanisms applicable to your infrastructure, including all the options of low and medium level settings.

- Medium (Default)—Enables some important detection mechanisms for your infrastructure. This includes all the options of the low level settings.
- Low—Enables only the most critical detection mechanisms for your infrastructure.
- Off—Disables all the detection mechanisms.

To enable custom settings, click **Custom Settings for Infrastructure** or **Custom Settings for Client** to manually enable or disable the detection mechanisms for your infrastructure and clients. To revert to the standard settings from the custom settings mode, click **Revert to Standard Settings**.

## Understanding Wizard Intrusion Protection

Apply the intrusion protection mechanisms for your infrastructure and clients . You can set the protection level to automatically enable the appropriate protection mechanisms or customize the settings for your infrastructure and clients.

### Protecting Your Infrastructure

Select the required protection settings for the infrastructure from the **Custom Settings for Infrastructure** table in the wizard. The following protections options are available to choose:

- Protect misconfigured AP
- Protect from adhoc networks
- Protect from adhoc networks - enhanced
- Protect from adhoc networks using valid SSID
- Protect SSID
- Protect 802.11n high throughput devices
- Protect 40mhz 802.11n high throughput devices
- Protect from AP impersonation
- Protect from wireless hosted networks
- Rogue containment
- Suspected rogue containment
- Suspected rogue confidence level > 90
- Suspected rogue confidence level > 80

### Protecting Your Clients

Select the required protection settings for the clients from the **Custom Settings for Client** table in the wizard. The following protections options are available to choose:

- Protect valid stations
- Protect windows bridge

## Monitoring the Security Dashboard

The **Security** page of **Dashboard** in the WebUI, allows you to monitor the detection and protection of wireless intrusions in your network.

The dashboard's two top tables— **Discovered APs & Clients** and **Events**—contain data as links. When these links are clicked, they arrange, filter, and display the appropriate information in the lower table.

For example, In the **Discovered APs & Clients** table, if you click a number in the **Active APs** column, the bottom table filters and arranges information about those classified Rogue APs. Use the scroll bar at the right to view all the Rogue APs.



The term *events* in this section is meant to include security threats, vulnerabilities, attacks (intrusion or Denial of Service) and other similarly related events.

Similarly, the **Event** table contains data links. You can click on these data links to view information, in the bottom table, related to the event you selected. You can use the scroll bar at the right to view all the events.

## Detecting Rogue APs

The most important WIP functionality is the ability to classify an AP as a potential security threat. An AP is considered to be rogue if it is both unauthorized and plugged in to the wired side of the network. An AP is considered to be interfering if it is seen in the RF environment but is not connected to the wired network.

While the interfering AP can potentially cause RF interference, it is not considered a direct security threat since it is not connected to the wired network. However, an interfering AP may be reclassified as a rogue AP.

### Understanding Classification Terminology

APs and clients are discovered during scanning of the wireless medium, and they are classified into various groups. The AP and client classification definitions are in [Table 89](#) and [Table 90](#).

**Table 89:** *AP Classification Definition*

Classification	Description
Valid AP	An AP that is part of the enterprise providing WLAN service.
Interfering AP	An AP that is seen in the RF environment but is not connected to the wired network. An interfering AP is not considered a direct security threat since it is not connected to the wired network. For example, an interfering AP can be an AP that belongs to a neighboring office's WLAN but is not part of your WLAN network.
Neighbor AP	A neighboring AP is when the BSSIDs are known. Once classified, a neighboring AP does not change its state.
Rogue AP	An unauthorized AP that is plugged into the wired side of the network.
Suspected-Rogue AP	A suspected rogue AP is an unauthorized AP that may be plugged into the wired side of the network.
Manually-contained AP	An AP for which DoS is enabled manually.

**Table 90:** *Client Classification Definitions*

Classification	Description
Valid Client	Any client that successfully authenticates with a valid AP and passes encrypted traffic.
Manually-contained Client	Any clients for which DoS is enabled manually.
Interfering Client	A client associated to any AP and is not valid.

## Understanding Classification Methodology

A discovered AP is classified as a rogue or a suspected rogue by the following methods:

- Internal heuristics
- AP classification rules
- Manually by the user

The internal heuristics works by checking if the discovered AP is communicating with a wired device on the customer network. This is done by matching the MAC address of devices that are on the discovered AP's network with that of the user's wired network. The MAC of the device on the discovered AP's network is known as the *Match MAC*. The ways in which the matching of wired MACs occurs is detailed in the sections [Understanding Match Methods on page 464](#) and [Understanding Match Types on page 464](#).

## Understanding Match Methods

The match methods are:

- **Plus One**—The match MAC matches a device whose MAC address' last bit was one more than that of the Match MAC.
- **Minus One**—The match MAC matches a device whose MAC address' last bit was one less than that of the Match MAC.
- **Equal**—The match was against the same MAC address.
- **OUI**—The match was against the manufacturer's OUI of the wired device.

The classification details are available in the **Discovered APs & Clients** section of the **Dashboard > Security** page of the WebUI. The information can be obtained by clicking on the details icon for a selected discovered AP. The information is also available in the **show wms rogue-ap** command.

## Understanding Match Types

- **Eth-Wired-MAC:** The MAC addresses of wired devices learned by an AP on its Ethernet interface.
- **GW-Wired-MAC:** The collection of Gateway MACs of all APs across Mobility Master and managed devices.
- **AP-Wired-MAC:** The MAC addresses of wired devices learned by monitoring traffic out of other valid and rogue APs.
- **Config-Wired-MAC:** The MAC addresses that are configured by the user, typically that of well-known servers in the network.
- **Manual:** User-triggered classification.
- **External-Wired-MAC:** The MAC address matched a set of known wired devices that are maintained in an external database.
- **Mobility-Manager:** The classification was determined by the mobility manager, AMP.



- **Classification-off:** AP is classified as rogue because classification has been disabled, causing all non-authorized APs to be classified as rogue.
- **Propagated-Wired-MAC:** The MAC addresses of wired devices learned by a different AP than the one that uses it for classifying a rogue.
- **Base-BSSID-Override:** The classification was derived from another BSSID, which belongs to the same AP that supports multiple BSSIDs on the radio interface.
- **AP-Rule:** A user-defined AP classification rule has matched.
- **System-Wired-MAC:** The MAC addresses of wired devices learned on the managed device.
- **System-Gateway-MAC:** The Gateway MAC addresses learned on the managed device.

## Understanding Suspected Rogue Confidence Level

A suspected rogue AP is a potential threat to the WLAN infrastructure. A suspected rogue AP has a confidence level associated with it. An AP can be marked as a suspected rogue if it is determined to be a potential threat on the wired network, or if it matches a user-defined classification rule.

The suspected-rogue classification mechanisms are:

- Each mechanism that causes a suspected-rogue classification is assigned a confidence level increment of 20%.
- AP classification rules have a configured confidence level.
- When a mechanism matches a previously unmatched mechanism, the confidence level increment associated with that mechanism is added to the current confidence level (the confidence level starts at zero).
- The confidence level is capped at 100%.
- If your managed device reboots, your suspected-rogue APs are not checked against any new rules that were configured after the reboot. Without this restriction, all the mechanisms that classified your APs as suspected-rogues may trigger again, causing the confidence level to surpass its cap of 100%. You can explicitly mark an AP as “interfering” to trigger all new rules to match against it.

## Understanding AP Classification Rules

AP classification rule configuration is performed only on Mobility Master. If AMP is enabled via the **mobility-manager** command, then processing of the AP classification rules is disabled on Mobility Master. A rule is identified by its ASCII character string name (32 characters maximum). The AP classification rules have one of the following specifications:

- SSID of the AP
- SNR of the AP
- Discovered-AP-Count or the number of APs that can see the AP

### Understanding SSID specification

Each rule can have up to 6 SSID parameters. If one or more SSIDs are specified in a rule, an option of whether to match any of the SSIDs or not match all of the SSIDs can be specified. The default is to check for a match operation.

### Understanding SNR specification

Each rule can have only one specification of the SNR. A minimum and/or maximum can be specified in each rule, and the specification is in SNR (db).

## Understanding Discovered-AP-Count specification

Each rule can have only one specification of the Discovered-AP-Count. Each rule can specify a minimum or maximum of the Discovered-AP-count. The minimum or maximum operation must be specified if the Discovered-AP-count is specified. The default setting is to check for the minimum discovered-AP-count.

### Sample Rules

If SSID equals xyz AND SNR > 40 then classify AP as suspected-rogue with conf-level-increment of 20

If SNR > 60 and DISCOVERING\_APS > 2, then classify AP as suspected-rogue with conf-level increment of 35

If SSID equals 'XYZ', then classify AP as known-neighbor

## Understanding Rule Matching

A rule must be enabled before it is matched. A maximum of 32 rules can be created with a maximum of 16 rules simultaneously active. If a rule matches, an AP is classified either as **Suspected-Rogue** or as **Neighbor**

For an AP classified as **Suspected-Rogue**, an associated confidence-level is provided (minimum is 5%).

The following mechanism is used for rule matching:

- When *all* the conditions specified in the rule evaluate to true, the rule matches.
- If multiple rules match, causing the AP to be classified as a Suspected-Rogue, the confidence level of each rule is aggregated to determine the confidence level of the classification.
- When multiple rules match and any one of those matching rules cause the AP to be classified as a Neighbor, then the AP is classified as Neighbor.
- APs classified as either Neighbor or Suspected-Rogue will attempt to match any configured AP rule.
- Once a rule matches an AP, the same rule will not be checked for the AP.
- When the managed device reboots, no attempt to match a previously matched AP is made.
- If a rule is disabled or modified, all APs that were previously classified based on that rule will continue to be in the newly classified state.

## Working with Intrusion Detection

This section covers Infrastructure and Client Intrusion Detections.

### Understanding Infrastructure Intrusion Detection

Detecting attacks against the infrastructure is critical in avoiding attacks that may lead to a large-scale Denial of Service (DoS) attack or a security breach. This group of features detects attacks against the WLAN infrastructure, which consists of authorized APs, the RF medium, and the wired network. An authorized or valid-AP is defined as an AP that belongs to the WLAN infrastructure. The AP is either an Aruba AP or a third party AP. ArubaOS automatically learns authorized Aruba APs.

[Table 91](#) presents a summary of the intrusion infrastructure detection features with their related commands, traps, and syslog identification. Feature details follow the table.

**Table 91: Infrastructure Detection Summary**

Feature	Command	Trap	Syslog ID
<a href="#">Detecting an 802.11n 40MHz Intolerance Setting on page 471</a>	ids dos-profile <profile-name> detect-ht-40mhz-intolerance client-ht-40mhz-intol-quiet-time	wlsxHT40MHzIntoleranceAP wlsxHT40MHzIntoleranceSta	1260 52, 1260 53, 1270 52, 1270 53
<a href="#">Detecting Active 802.11n Greenfield Mode on page 471</a>	ids unauthorized-device-profile <profile-name> detect-ht-greenfield	wlsxHtGreenfieldSupported	1260 54, 1270 54
<a href="#">Detecting Ad hoc Networks on page 471</a>	ids unauthorized-device-profile <profile-name> detect-adhoc-network	wlsxNAAdhocNetwork	1260 33, 1270 33
<a href="#">Detecting an Ad hoc Network Using a Valid SSID on page 471</a>	ids unauthorized-device-profile <profile-name> detect-adhoc-using-valid-ssid adhoc-using-valid-ssid-quiet-time	wlsxAdhocUsingValidSSID	1260 68, 1270 68
<a href="#">Detecting an AP Flood Attack on page 471</a>	ids dos-profile <profile-name> detect-ap-flood ap-flood-threshold ap-flood-inc-time ap-flood-quiet-time	wlsxApFloodAttack	1260 34, 1270 34
<a href="#">Detecting AP Impersonation on page 471</a>	ids impersonation-profile <profile-name> detect-ap-impersonation beacon-diff-threshold beacon-inc-wait-time	wlsxAPImpersonation	1260 06, 1270 06
<a href="#">Detecting AP Spoofing on page 471</a>	ids impersonation-profile <profile-name> detect-ap-spoofing ap-spoofing-quiet-time	wlsxAPSpoofingDetected wlsxClientAssociatingOn WrongChannel	1260 69, 1260 70, 1270 69, 1270 70

Feature	Command	Trap	Syslog ID
<a href="#">Detecting Bad WEP Initialization on page 471</a>	ids unauthorized-device-profile <profile-name> detect-bad-wep	wlsxRepeatWEPIVViolation wlsxStaRepeatWEPIVViolation wlsxWeakWEPIVViolation wlsxStaWeakWEPIVViolation	1260 14, 1260 15, 1260 16, 1260 17, 1270 14, 1270 15, 1270 16, 1270 17
<a href="#">Detecting a Beacon Frame Spoofing Attack on page 471</a>	ids impersonation-profile <profile-name> detect-beacon-wrong-channel beacon-wrong-channel-quiet-time	wlsxMalformedFrameWrongChannel Detected	1260 86, 1270 86
<a href="#">Detecting a Client Flood Attack on page 472</a>	ids dos-profile <profile-name> detect-client-flood client-flood-threshold client-flood-inc-time client-flood-quiet-time	wlsxClientFloodAttack	1260 64, 1270 64
<a href="#">Detecting a CTS Rate Anomaly</a>	ids dos-profile <profile-name> detect-cts-rate-anomaly cts-rate-threshold cts-rate-time-interval cts-rate-quiet-time	wlsxCtsRateAnomaly	1260 73, 1270 73
<a href="#">Detecting Devices with an Invalid MAC OUI on page 472</a>	ids unauthorized-device-profile <profile-name> detect-invalid-mac-oui mac-oui-quiet-time	wlsxInvalidMacOUIAP wlsxInvalidMacOUISta	1260 29, 1260 30, 1270 29, 1270 30
<a href="#">Detecting an Invalid Address Combination on page 472</a>	ids dos-profile <profile-name> detect-invalid-address-combination invalid-address-combination-quiet-time	wlsxInvalidAddressCombination	1260 79, 1270 79
<a href="#">Detecting an Overflow EAPOL Key on page 472</a>	ids dos-profile <profile-name> detect-overflow-eapol-key overflow-eapol-key-quiet-time	wlsxMalformedOverflowEAPOLKey Detected	1260 82, 1270 82

Feature	Command	Trap	Syslog ID
<a href="#">Detecting Overflow IE Tags on page 472</a>	ids dos-profile <profile-name> detect-overflow-ie overflow-ie-quiet-time	wlsxOverflowIEDetected	1260 84, 1270 84
<a href="#">Detecting a Malformed Frame-Assoc Request on page 472</a>	ids dos-profile <profile-name> detect-malformed-assoc-req malformed-assoc-req-quiet-time	wlsxMalformedAssocReqDetected	1260 80, 1270 80
<a href="#">Detecting Malformed Frame-Auth on page 473</a>	ids dos-profile <profile-name> detect-malformed-frame-auth malformed-auth-frame-quiet-time	wlsxMalformedAuthFrameDetected	1260 83, 1270 83
<a href="#">Detecting a Malformed Frame-HT IE on page 473</a>	ids dos-profile <profile-name> detect-malformed-htie malformed-htie-quiet-time	wlsxMalformedHTIEDetected	1260 81, 1270 81
<a href="#">Detecting a Malformed Frame-Large Duration on page 473</a>	ids-dos-profile <profile-name> detect-malformed-large-duration malformed-large-duration-quiet-time	wlsxMalformedFrameLargeDuration Detected	1260 85, 1270 85
<a href="#">Detecting a Misconfigured AP on page 473</a>  (WEP, WPA, SSID, Channel, OUI)	ids unauthorized-device-profile <profile-name> detect-misconfigured-ap privacy require-wpa valid-and-protected-ssid cfg-valid-11g-channel cfg-valid-11a-channel valid-oui	wlsxWEPMisconfiguration wlsxWPAMisconfiguration wlsxSSIDMisconfiguration wlsxChannelMisconfiguration wlsxOUIMisconfiguration	1260 11, 1260 28, 1260 10, 1260 08, 1260 09, 1270 11, 1270 28, 1270 10, 1270 08, 1270 09
<a href="#">Detecting a CTS Rate Anomaly on page 472</a>	ids dos-profile <profile-name> detect-rts-rate-anomaly rts-rate-threshold rts-rate-time-interval rts-rate-quiet-time	wlsxRtsRateAnomaly	1260 74, 1270 74

Feature	Command	Trap	Syslog ID
<a href="#">Detecting a Windows Bridge on page 473</a>	ids unauthorized-device-profile <profile-name> detect-windows-bridge	wlsxWindowsBridgeDetectedAP  wlsxWindowsBridgeDetectedSta  wlsxNAdhocNetworkBridgeDetected  AP  wlsxNAdhocNetworkBridgeDetected Sta	1260 39, 1260 40, 1260 41, 1260 42, 1270 39, 1270 40, 1270 41, 1270 42
<a href="#">Detecting a Wireless Bridge on page 473</a>	ids unauthorized-device-profile <profile-name> detect-wireless-bridge wireless-bridge-quiet-time	wlsxWirelessBridge	1260 36, 1270 36
<a href="#">Detecting Broadcast Deauthentication on page 473</a>	ids signature-matching-profile <profile-name> signature deauth-Broadcast  ids general-profile <profile-name> signature-quiet-time	wlsxNSignatureMatchDeathBroadcast	1260 47, 1270 47
<a href="#">Detecting Broadcast Disassociation on page 473</a>	ids signature-matching-profile <profile-name> signature disassoc-Broadcast  ids general-profile <profile-name> signature-quiet-time	wlsxNSignatureMatchDisassocBcast	1260 66, 1270 66
<a href="#">Detecting Netstumbler on page 473</a>	ids signature-matching-profile <profile-name> signature 'Netstumbler Generic' signature 'Netstumbler Version 3.3.0.x'  ids general-profile <profile-name> signature-quiet-time	wlsxNSignatureMatchNetstumbler	1260 43, 1270 43
<a href="#">Detecting Valid SSID Misuse on page 473</a>	ids-unauthorized-device-profile <profile-name> detect-valid-ssid-misuse valid-and-protected-ssid	wlsxValidSSIDViolation	1260 07, 1270 07
<a href="#">Detecting Wellenreiter on page 474</a>	ids signature-matching-profile <profile-name> signature Wellenreiter  ids general-profile <profile-name> signature-quiet-time	wlsxNSignatureMatchWellenreiter	1260 67, 1270 67

## Detecting an 802.11n 40MHz Intolerance Setting

When a client sets the HT capability **intolerant** bit to indicate that it is unable to participate in a 40MHz BSS, the AP must use lower data rates with all of its clients. Network administrators often want to know if there are devices that are advertising 40MHz intolerance, as this can impact the performance of the network.

## Detecting Active 802.11n Greenfield Mode

When 802.11 devices use the HT operating mode, they can not share the same channel as 802.11 a/b/g stations. Not only can they not communicate with legacy devices, the way they use the transmission medium is different, which would cause collisions, errors, and retransmissions.

## Detecting Ad hoc Networks

An adhoc network is a collection of wireless clients that form a network amongst themselves without the use of an AP. As far as network administrators are concerned, adhoc wireless networks are uncontrolled. If they do not use encryption, they may expose sensitive data to outside eavesdroppers. If a device is connected to a wired network and has bridging enabled, an adhoc network may also function like a rogue AP. Additionally, adhoc networks can expose client devices to viruses and other security vulnerabilities. For these reasons, many administrators choose to prohibit adhoc networks.

## Detecting an Ad hoc Network Using a Valid SSID

If an unauthorized adhoc network is using the same SSID as an authorized network, a valid client may be tricked into connecting to the wrong network. If a client connects to a malicious adhoc network, security breaches or attacks can occur.

## Detecting an AP Flood Attack

Fake AP is a tool that was originally created to thwart wardrivers by flooding beacon frames containing hundreds of different addresses. This would appear to a wardriver as though there were hundreds of APs in the area, thus concealing the real AP. An attacker can use this tool to flood an enterprise or public hotspots with fake AP beacons to confuse legitimate users and to increase the amount of processing need on client operating systems.

## Detecting AP Impersonation

In AP impersonation attacks, the attacker sets up an AP that assumes the BSSID and ESSID of a valid AP. AP impersonation attacks can be done for man-in-the-middle attacks, a rogue AP attempting to bypass detection, or a honeypot attack.

## Detecting AP Spoofing

An AP Spoofing attack involves an intruder sending forged frames that are made to look like they are from a legitimate AP. It is trivial for an attacker to do this, since tools are readily available to inject wireless frames with any MAC address that the user desires. Spoofing frames from a legitimate AP is the foundation of many wireless attacks.

## Detecting Bad WEP Initialization

This is the detection of WEP initialization vectors that are known to be weak. A primary means of cracking WEP keys is to capture 802.11 frames over an extended period of time and searching for such weak implementations that are still used by many legacy devices.

## Detecting a Beacon Frame Spoofing Attack

In this type of attack, an intruder spoofs a beacon packet on a channel that is different from that advertised in the beacon frame of the AP.

## Detecting a Client Flood Attack

There are fake AP tools that can be used to attack wireless intrusion detection itself by generating a large number of fake clients that fill internal tables with fake information. If successful, it overwhelms the wireless intrusion system, resulting in a DoS.

## Detecting a CTS Rate Anomaly

The RF medium can be reserved via Virtual Carrier Sensing using a Clear To Send (CTS) transaction. The transmitter station sends a Ready To Send (RTS) frame to the receiver station. The receiver station responds with a CTS frame. All other stations that receive these CTS frames will refrain from transmitting over the wireless medium for an amount of time specified in the *duration* fields of these frames.

Attackers can exploit the Virtual Carrier Sensing mechanism to launch a DoS attack on the WLAN by transmitting numerous RTS and/or CTS frames. This causes other stations in the WLAN to defer transmission to the wireless medium. The attacker can essentially block the authorized stations in the WLAN with this attack.

## Detecting an RTS Rate Anomaly

The RF medium can be reserved via Virtual Carrier Sensing using an RTS transaction. The transmitter station sends a RTS frame to the receiver station. The receiver station responds with a CTS frame. All other stations that receive these RTS frames will refrain from transmitting over the wireless medium for an amount of time specified in the *duration* fields of these frames.

Attackers can exploit the Virtual Carrier Sensing mechanism to launch a DoS attack on the WLAN by transmitting numerous RTS and/or CTS frames. This causes other stations in the WLAN to defer transmission to the wireless medium. The attacker can essentially block the authorized stations in the WLAN with this attack.

## Detecting Devices with an Invalid MAC OUI

The first three bytes of a MAC address, known as the MAC organizationally unique identifier (OUI), is assigned by the IEEE to known manufacturers. Often, clients using a spoofed MAC address do not use a valid OUI and instead use a randomly generated MAC address.

## Detecting an Invalid Address Combination

In this attack, an intruder can cause an AP to transmit deauthentication and disassociation frames to all of its clients. Triggers that can cause this condition include the use of broadcast or multicast MAC address in the source address field.

## Detecting an Overflow EAPOL Key

Some wireless drivers used in access points do not correctly validate the EAPOL key fields. A malicious EAPOL-Key packet with an invalid advertised length can trigger a DoS or possible code execution. This can only be achieved after a successful 802.11 association exchange.

## Detecting Overflow IE Tags

Some wireless drivers used in access points do not correctly parse the vendor-specific IE tags. A malicious association request sent to the AP containing an IE with an inappropriate length (too long) can cause a DoS and potentially lead to code execution. The association request must be sent after a successful 802.11 authentication exchange.

## Detecting a Malformed Frame-Assoc Request

Some wireless drivers used in access points do not correctly parse the SSID information element tag contained in association request frames. A malicious association request with a null SSID (that is, zero length SSID) can trigger a DoS or potential code execution condition on the targeted device.



## Detecting Malformed Frame-Auth

Malformed 802.11 authentication frames that do not conform to the specification can expose vulnerabilities in some drivers that have not implemented proper error checking. This feature checks for unexpected values in an Authentication frame.

## Detecting a Malformed Frame-HT IE

The IEEE 802.11n HT (High Throughput) IE is used to convey information about the 802.11n network. An 802.11 management frame containing a malformed HT IE can crash some client implementations, potentially representing an exploitable condition when transmitted by a malicious attacker.

## Detecting a Malformed Frame-Large Duration

The virtual carrier-sense attack is implemented by modifying the 802.11 MAC layer implementation to allow random duration values to be sent periodically. This attack can be carried out on the ACK, data, RTS, and CTS frame types by using large duration values. This attack can prevent channel access to legitimate users.

## Detecting a Misconfigured AP

A list of parameters can be configured to define the characteristics of a valid AP. This feature is primarily used when non-Aruba APs are used in the network, since the Aruba devices cannot configure the third-party APs. These parameters include WEP, WPA, OUI of valid MAC addresses, valid channels, and valid SSIDs.

## Detecting a Windows Bridge

A Windows Bridge occurs when a client that is associated to an AP is also connected to the wired network, and has enabled bridging between these two interfaces.

## Detecting a Wireless Bridge

Wireless bridges are normally used to connect multiple buildings together. However, an attacker could place (or have an authorized person place) a wireless bridge inside the network that would extend the corporate network somewhere outside the building. Wireless bridges are somewhat different from rogue APs, in that they do not use beacons and have no concept of association. Most networks do not use bridges – in these networks, the presence of a bridge is a signal that a security problem exists.

## Detecting Broadcast Deauthentication

A deauthentication broadcast attempts to disconnect all stations in range. Rather than sending a spoofed deauth to a specific MAC address, this attack sends the frame to a broadcast address.

## Detecting Broadcast Disassociation

By sending disassociation frames to the broadcast address (FF:FF:FF:FF:FF:FF), an attacker can disconnect all stations on a network for a widespread DoS.

## Detecting Netstumbler

NetStumbler is a popular wardriving application used to locate 802.11 networks. When used with certain NICs, NetStumbler generates a characteristic frame that can be detected. Version 3.3.0 of NetStumbler changed the characteristic frame slightly.

## Detecting Valid SSID Misuse

If an unauthorized AP (neighbor or interfering) is using the same SSID as an authorized network, a valid client may be tricked into connecting to the wrong network. If a client connects to a malicious network, security breaches or attacks can occur.

## Detecting Wellenreiter

Wellenreiter is a passive wireless network discovery tool used to compile a list of APs along with their MAC address, SSID, channel, and security setting in the vicinity. It passively sniffs wireless traffic, and with certain version (versions 1.4, 1.5, and 1.6), sends active probes that target known default SSIDs.

## Understanding Client Intrusion Detection

Generally, clients are more vulnerable to attacks than APs. Clients are more apt to associate with a malignant AP due to the client's driver behavior or a misconfigured client. It is important to monitor authorized clients to track their associations and to track any attacks raised against the client. Client attack detection is categorized as:

- **Detecting attacks against Aruba APs clients:** An attacker can perform an active DOS attack against an associated client, or perform a replay attack to obtain the keys of transmission which could lead to more serious attacks.
- **Monitoring Authorized clients:** Since clients are easily tricked into associating with unauthorized APs, tracking all misassociations of authorized clients is very important.

An authorized client is a client authorized to use the WLAN network. In ArubaOS, an authorized client is called a *valid-client*. ArubaOS automatically learns a valid client. A client is determined to be valid if it is associated to an authorized or valid AP using encryption; either Layer 2 or IPsec.



Detection of attacks is limited to valid clients and clients associated to valid APs. Clients that are associated as guests using unencrypted association are included in the attack detection. However, clients on neighboring (interfering) APs are not tracked for attack detection unless they are specified as valid.

[Table 92](#) presents a summary of the client intrusion detection features with their related commands, traps, and syslog identification. Details of each feature follow the table.

**Table 92:** *Client Detection Summary*

Feature	Command	Trap	Syslog ID
<a href="#">Detecting a Block ACK DoS on page 476</a>	ids-dos-profile <profile-name> detect-block-ack-attack block-ack-quiet-time	wlsxBlockAckAttackDetected	1260 87, 1270 87
<a href="#">Detecting a ChopChop Attack on page 476</a>	ids-dos-profile <profile-name> detect-chopchop-attack chopchop-quiet-time	wlsxChopChopAttackDetected	1260 78, 1270 78
<a href="#">Detecting a Disconnect Station Attack on page 476</a>	ids dos-profile <name> detect-disconnect-sta disconnect-sta-quiet-time disconnect-sta-assoc-resp-threshold disconnect-death-disassoc-threshold	wlsxNDisconnectStationAttack	1260 35, 1270 35
<a href="#">Detecting an EAP Rate Anomaly on page 476</a>	ids-dos-profile <profile-name> detect-eap-rate-anomaly eap-rate-threshold eap-rate-time-interval eap-rate-quiet-time	wlsxEAPRateAnomaly	1260 32, 1270 32

Feature	Command	Trap	Syslog ID
<a href="#">Detecting a FATA-Jack Attack Structure on page 476</a>	ids dos-profile <profile-name> detect-fatajack-attack fatajack-attack-quiet-time	wlsxFatajackAttackDetected	1260 72, 1270 72
<a href="#">Detecting a Hotspotter Attack on page 477</a>	ids impersonation-profile <profile-name> detect-hotspotter-attack hotspotter-quiet-time	wlsxHotspotterAttackDetected	1260 88, 1270 88
<a href="#">Detecting a Meiners Power Save DoS Attack on page 477</a>	ids dos-profile <profile-name> detect-power-save-dos-attack power-save-dos-min-frames power-save-dos-quiet-time power-save-dos-threshold	wlsxPowerSaveDoSAttack	1261 09, 1271 09
<a href="#">Detecting an Omerta Attack on page 477</a>	ids dos-profile <profile-name> detect-omerta-attack omerta-attack-threshold omerta-attack-quiet-time	wlsxOmertaAttack	1260 71, 1270 71
<a href="#">Detecting Rate Anomalies on page 477</a>	ids dos-profile <profile-name> detect-rate-anomalies  assoc-rate-thresholds disassoc-rate-thresholds death-rate-thresholds probe-request-rate-thresholds probe-response-rate-thresholds auth-rate-thresholds	wlsxChannelRateAnomaly wlsxNodeRateAnomalyAP wlsxNodeRateAnomalySta	1260 61, 1260 62, 1260 63, 1270 61, 1270 62, 1270 63
<a href="#">Detecting a TKIP Replay Attack on page 477</a>	ids dos-profile detect-tkip-replay-attack tkip-replay-quiet-time	wlsxTkipReplayAttackDetected	1260 77, 1270 77
<a href="#">Detecting Unencrypted Valid Clients on page 477</a>	ids unauthorized-device-profile detect-unencrypted-valid-client unencrypted-valid-client-quiet-time	wlsxValidClientNotUsingEncryption	1260 65, 1270 65
<a href="#">Detecting a Valid Client Misassociation on page 477</a>	ids unauthorized-device-profile detect-valid-client-misassociation	wlsxValidClientMisassociation	1260 75, 1270 75

Feature	Command	Trap	Syslog ID
<a href="#">Detecting an AirJack Attack on page 478</a>	ids signature-matching-profile signature AirJack  ids general-profile signature-quiet-time	wlsxNSignatureMatchAirjack	1260 46, 1270 46
<a href="#">Detecting ASLEAP on page 478</a>	ids signature-matching-profile signature ASLEAP  ids general-profile signature-quiet-time	wlsxNSignatureMatchAsleep	1260 44, 1270 44
<a href="#">Detecting a Null Probe Response on page 478</a>	ids signature-matching-profile signature Null Probe Response  ids general-profile signature-quiet-time	wlsxNSignatureMatchNullProbeR esp	1260 45, 1270 45

### Detecting a Block ACK DoS

The Block ACK mechanism that was introduced in 802.11e, and enhanced in 802.11nD3.0, has a built-in DoS vulnerability. The Block ACK mechanism allows for a sender to use the ADDBA request frame to specify the sequence number window that the receiver should expect. The receiver will only accept frames in this window.

An attacker can spoof the ADDBA request frame causing the receiver to reset its sequence number window and thereby drop frames that do not fall in that range.

### Detecting a ChopChop Attack

ChopChop is a plaintext recovery attack against WEP encrypted networks. It works by forcing the plaintext, one byte at a time, by truncating a captured frame and then trying all 256 possible values for the last byte with a corrected CRC. The correct guess causes the AP to retransmit the frame. When that happens, the frame is truncated again.

### Detecting a Disconnect Station Attack

A disconnect attack can be launched in many ways; the end result is that the client is effectively and repeatedly disconnected from the AP.

### Detecting an EAP Rate Anomaly

To authenticate wireless clients, WLANs may use 802.1X, which is based on a framework called Extensible Authentication Protocol (EAP). After an EAP packet exchange, and the user is successfully authenticated, the EAP-Success is sent from the AP to the client. If the user fails to authenticate, an EAP-Failure is sent. In this attack, EAP-Failure or EAP-Success frames are spoofed from the access point to the client to disrupting the authentication state on the client. This confuses the client's state, causing it to drop the AP connection. By continuously sending EAP Success or Failure messages, an attacker can effectively prevent the client from authenticating with the APs in the WLAN.

### Detecting a FATA-Jack Attack Structure

FATA-Jack is an 802.11 client DoS tool that tries to disconnect targeted stations using spoofed authentication frames that contain an invalid authentication algorithm number.

## Detecting a Hotspotter Attack

The Hotspotter attack is an evil-twin attack which attempts to lure a client to a malicious AP. Many enterprise employees use their laptop in Wi-Fi area hotspots at airports, cafes, malls etc. They have SSIDs of their hotspot service providers configured on their laptops. The SSIDs used by different hotspot service providers are well known. This enables the attackers to set up APs with hotspot SSIDs in close proximity of the enterprise premises. When the enterprise laptop Client probes for hotspot SSIDs, these malicious APs respond and invite the client to connect to them. When the client connects to a malicious AP, a number of security attacks can be launched on the client. Airsnarf is a popular hacking tool used to launch these attacks.

## Detecting a Meiners Power Save DoS Attack

To save on power, wireless clients will sleep periodically, during which they cannot transmit or receive. A client indicates its intention to sleep by sending frames to the AP with the Power Management bit ON. The AP then begins buffering traffic bound for that client until it indicates that it is awake. An intruder could exploit this mechanism by sending (spoofed) frames to the AP on behalf of the client to trick the AP into believing the client is asleep. This will cause the AP to buffer most, if not all, frames destined for the client.

## Detecting an Omerta Attack

Omerta is an 802.11 DoS tool that sends disassociation frames to all stations on a channel in response to data frames. The Omerta attack is characterized by disassociation frames with a reason code of 0x01. This reason code is unspecified and is not used under normal circumstances.

## Detecting Rate Anomalies

Many DoS attacks flood an AP or multiple APs with 802.11 management frames. These can include authenticate/associate frames, which are designed to fill up the association table of an AP. Other management frame floods, such as probe request floods, can consume excess processing power on the AP.

## Detecting a TKIP Replay Attack

TKIP is vulnerable to replay (via WMM/QoS) and plaintext discovery (via ChopChop). This affects all WPA-TKIP usage. By replaying a captured TKIP data frame on other QoS queues, an attacker can manipulate the RC4 data and checksum to derive the plaintext at a rate of one byte per minute.

By targeting an ARP frame and guessing the known payload, an attacker can extract the complete plaintext and MIC checksum. With the extracted MIC checksum, an attacker can reverse the MIC AP to Station key and sign future messages as MIC compliant, opening the door for more advanced attacks.

## Detecting Unencrypted Valid Clients

An authorized (valid) client that is passing traffic in unencrypted mode is a security risk. An intruder can sniff unencrypted traffic (also known as *packet capture*) with software tools known as sniffers. These packets are then reassembled to produce the original message.

## Detecting a Valid Client Misassociation

This feature does not detect attacks, but rather it monitors authorized (valid) wireless clients and their association within the network. Valid client misassociation is potentially dangerous to network security. The four types of misassociation that we monitor are:

- **Authorized Client associated to Rogue:** A valid client that is associated to a rogue AP.
- **Authorized Client associated to External AP:** An external AP, in this context, is any AP that is not valid and not a rogue.
- **Authorized Client associated to Honeypot AP:** A honeypot is an AP that is not *valid* but is using an SSID that has been designated as valid/protected.
- **Authorized Client in ad hoc connection mode:** A valid client that has joined an ad hoc network.

## Detecting an AirJack Attack

AirJack is a suite of device drivers for 802.11(a/b/g) raw frame injection and reception. It was intended to be used as a development tool for all 802.11 applications that need to access the raw protocol. However, one of the tools included allowing users to force all users off an AP.

## Detecting ASLEAP

ASLEAP is a tool created for Linux systems used to attack Cisco LEAP authentication protocol.

## Detecting a Null Probe Response

A null probe response attack has the potential to crash or lock up the firmware of many 802.11 NICs. In this attack, a client probe-request frame will be answered by a probe response containing a null SSID. A number of popular NIC cards will lock up upon receiving such a probe response.

## Configuring Intrusion Protection

Intrusion protection features support containment of an AP or a client. In the case of an AP, we will attempt to disconnect all clients that are connected or attempting to connect to the AP. In the case of a client, the client's association to an AP is targeted. The following containment mechanisms are supported:

- **Deauthentication containment:** An AP or client is contained by disrupting its association on the wireless interface.
- **Tarpit containment:** An AP is contained by luring clients that are attempting to associate with it to a tarpit. The tarpit can be on the same channel as the AP being contained, or on a different channel (see [Tarpit Shielding Overview on page 494](#)).
- **Wired containment:** An AP or client is contained by disrupting its connection on the wired interface.

The WIP feature supports separate enforcement policies that use the underlying containment mechanisms to contain an AP or a client that do not conform to the policy. These policies are discussed in the sections that follow.

## Understanding Infrastructure Intrusion Protection

[Table 93](#) presents a summary of the infrastructure intrusion protection features with their related commands, traps, and syslog identifications. Details of each feature follow the table.

**Table 93:** *Infrastructure Protection Summary*

Feature	Command
<a href="#">Protecting 40MHz 802.11 High Throughput Devices on page 479</a>	<code>ids unauthorized-device-profile &lt;profile-name&gt; protect-ht-40mhz</code>
<a href="#">Protecting 802.11n High Throughput Devices on page 479</a>	<code>ids unauthorized-device-profile &lt;profile-name&gt; protect-high-throughput</code>
<a href="#">Protecting Against Adhoc Networks on page 479</a>	<code>ids unauthorized-device-profile &lt;profile-name&gt; protect-adhoc-enhanced protect-adhoc-network</code>

Feature	Command
<a href="#">Protecting Against Adhoc Networks Using Valid SSID on page 479</a>	<code>ids unauthorized-device-profile &lt;profile-name&gt; protect-adhoc-using-valid-ssid</code>
<a href="#">Protecting Against AP Impersonation on page 480</a>	<code>ids impersonation-profile &lt;profile-name&gt; protect-ap-impersonation</code>
<a href="#">Protecting Against Misconfigured APs on page 480</a>	<code>ids unauthorized-device-profile &lt;profile-name&gt; protect-misconfigured-ap</code>
<a href="#">Protecting SSIDs on page 480</a>	<code>ids unauthorized-device-profile &lt;profile-name&gt; protect-ssid</code>
<a href="#">Protecting Against Wireless Hosted Networks on page 480</a>	<code>ids unauthorized-device-profile &lt;profile-name&gt; detect-wireless-hosted-network protect-wireless-hosted-network</code>
<a href="#">Protecting Against Rogue Containment on page 480</a>	<code>ids unauthorized-device-profile &lt;profile-name&gt; rogue-containment</code>
<a href="#">Protecting Against Suspected Rogue Containment on page 480</a>	<code>ids unauthorized-device-profile suspect-rogue-containment suspect-rogue-conf-level</code>
<a href="#">Protection against Wired Rogue APs on page 480</a>	<code>ids general-profile wired-containment wired-containment-ap-adj-mac wired-containment-susp-l3-rogue</code>

## Protecting 40MHz 802.11 High Throughput Devices

Protection from AP(s) that support 40MHz HT involves containing the AP such that clients can not connect.

## Protecting 802.11n High Throughput Devices

Protection from AP(s) that support HT involves containing the AP such that clients can not connect.

## Protecting Against Adhoc Networks

Protection from an adhoc network involves containing the adhoc network so that clients cannot connect to it. The basic adhoc protection feature protects against adhoc networks using WPA/WPA2 security. The enhanced adhoc network protection feature protects against open/WEP adhoc networks. Both features can be used together for maximum protection, or enabled or disabled separately.




---

This feature requires that you enable the **wireless-containment** setting in the IDS general profile.

---

## Protecting Against Adhoc Networks Using Valid SSID

Protection from adhoc networks using valid SSID involves containing the adhoc networks that use a valid or protected SSIDs so that clients cannot connect to it. This feature provides protection against WPA/WPA2/WEP/open adhoc networks.

## Protecting Against AP Impersonation

Protection from AP impersonation involves containing both the legitimate and impersonating AP so that clients can not connect to either AP.

## Protecting Against Misconfigured APs

Protect Misconfigured AP enforces that valid APs are configured properly. An offending AP is contained by preventing clients from associating to it.

## Protecting Against Wireless Hosted Networks

Clients using the Windows wireless hosted network feature can act as an access point to which other wireless clients can connect, effectively becoming a Wi-Fi HotSpot. This creates a security issue for enterprises, because unauthorized users can use a hosted network to gain access to the corporate network, and valid users that connect to a hosted network are vulnerable to attacks or security breaches. This feature detects a wireless hosted network, and contains the client hosting this network.

## Protecting SSIDs

Protect SSID enforces that valid/protected SSIDs are used only by valid APs. An offending AP is contained by preventing clients from associating to it.

## Protecting Against Rogue Containment

By default, rogue APs are not automatically disabled. Rogue containment automatically disables a rogue AP by preventing clients from associating to it.

## Protecting Against Suspected Rogue Containment

By default, suspected rogue APs are not automatically contained. In combination with the suspected rogue containment confidence level, suspected rogue containment automatically disables a suspect rogue by preventing clients from associating to it.

## Protection against Wired Rogue APs

This feature enables containment from the wired side of the network. The basic wired containment feature in the IDS general profile isolates layer-3 APs whose wired interface MAC addresses are the same as (or one character off from) their BSSIDs. The enhanced wired containment feature introduced in ArubaOS 6.3 can also identify and contain an AP with a preset wired MAC address that is completely different from the AP's BSSID. In many non-Aruba APs, the MAC address the AP provides to wireless clients as a 'gateway MAC' is offset by one character from its wired MAC address. This enhanced feature allows ArubaOS to check to see if a suspected Layer-3 rogue AP's MAC address follows this common pattern.

## Understanding Client Intrusion Protection

[Table 94](#) list the client intrusion protection features with their related commands, traps, and syslog identifications. Details of each feature follow the table.

**Table 94:** *Client Protection Summary*

Feature	Command
<a href="#">Protecting Valid Stations on page 481</a>	<code>ids unauthorized-device-profile &lt;profile-name&gt;</code> <code>protect-valid-sta</code>
<a href="#">Protecting Windows Bridge on page 481</a>	<code>ids unauthorized-device-profile &lt;profile-name&gt;</code> <code>protect-windows-bridge</code>



## Protecting Valid Stations

Protecting a valid client involves disconnecting that client if it is associated to a non-valid AP.

## Protecting Windows Bridge

Protecting from a Windows Bridge involves containing the client that is forming the bridge so that it can not connect to the AP.

## Warning Message for Containment Features

The feature for enabling wireless containment under the **IDS Unauthorized Device** profile and **IDS Impersonation** profile may be in violation of certain Federal Communications Commission (FCC) regulatory statutes. To address this, a warning message is issued each time the command is enabled:

- If enabled through the WebUI, the warning message will appear before the command is executed.
- If enabled through the CLI, the warning message will appear after the command is executed

## Configuring the WLAN Management System (WMS)

The WLAN management system (WMS) on Mobility Master monitors wireless traffic to detect any new AP or wireless client station in the RF environment. When an AP or wireless client is detected, it is classified, and its classification is used to determine the security policies that should be enforced on the AP or client. By default, the WMS service is terminated at Mobility Master, which requires every AP across the network to communicate with the WMS service on Mobility Master.

### Configuring General WMS settings

Use the IDS WMS General profile to configure general WMS settings such as AP ageout times and update intervals, and enable the collection of statistics for monitored APs and clients.

#### In the WebUI

To configure the IDS WMS General profile

1. In the **Mobility Master** node hierarchy, navigate to **Configuration > System > Profiles**.
2. Expand the **IDS** menu and select **IDS WMS General**.
3. Configure the parameters as described in [Table 95](#) and then click **Save**.
4. Click **Pending Changes**.
5. In the **Pending Changes** window, select the check box and click **Deploy changes**.

**Table 95: WMS Configuration Parameters**

Parameter	Description
AP poll interval	Interval, in milliseconds, for communication between the managed device and Aruba APs. The managed device contacts the AP at this interval to download AP to station associations, update policy configuration changes, and download AP and station statistics. Default: 60000 milliseconds (1 minute)
AP poll retries	Maximum number of failed polling attempts before the polled AP is considered to be down. Default: 3
AP ageout interval	The amount of time, in minutes, that an AP is unseen by any probes before it is deleted from the database. Enter 0 to disable ageout. Default: 30 minutes
Adhoc AP ageout interval	The amount of time, in minutes, that an adhoc (IBSS) AP unseen by any problems before it is deleted from the database. Enter 0 to disable ageout. Default: 5 minutes
Station ageout Interval	The amount of time, in minutes, that a client is unseen by any probes before it is deleted from the database. Enter 0 to disable ageout. Default: 30 minutes
Statistics update	Enables or disables statistics update in the database. Default: disabled
Persistent Neighbor APs	When enabled, this feature prevents APs that are marked as neighbor APs from being aged out. Default: disabled
Persistent Valid STAs	When enabled, this feature prevents valid stations from being aged out. Default: disabled
AP learning	Enables or disables AP learning. Learning affects the way APs are classified. Default: disabled

Parameter	Description
Propagate Wired Macs	Enables the propagation of the gateway wired MAC information. Default: enabled
Collect Stats for Monitored APs and Clients	Enables collection of statistics (up to 25,000 entries) on Mobility Master for monitored APs and clients. Default: disabled
Learn System Wired Macs:	Enable or disable “learning” of wired MACs on the managed device. Default: disabled

### In the CLI

Use the following command to configure WMS via the CLI. The parameters in this command are described in detail in [Table 95](#).

```
(host)[mynode]config# ids wms-general-profile
```

### Configuring Local WMS Settings

The configuration parameters in IDS WMS local system profile allow the user to change the default behavior and table sizes of the WMS on specific managed devices.

### Configuring Local WMS Settings In the WebUI

To configure the IDS WMS Local System profile

1. In the **Mobility Master** node hierarchy, navigate to **Configuration > System > Profiles**.
2. Expand the **IDS** menu and select **IDS WMS Local System**.
3. Configure the parameters as described in [Table 96](#) and then click **Save**.
4. Click **Pending Changes**.
5. In the **Pending Changes** window, select the check box and click **Deploy changes**.

**Table 96:** *IDS WMS Local System Profile Settings*

Parameter	Description
Max AP Threshold	Set the max threshold for the total number of APs
Max RBTREE Entries	Set the max threshold for the total number of AP and station RBTREE entries.
Max STA Threshold	Set the max threshold for the total number of stations.
Max System Wired MACs	Set the max number of system wired MAC table entries learned by the managed device.

Parameter	Description
Override Service Termination	Override the system-determined termination mode, and terminate WMS service at the managed device to which the AP is associated. Do not use this option if you have multiple managed devices in one location, as WMS will not operate correctly. For more information, see <a href="#">Mobility Master WMS Termination vs. Managed Device WMS Termination on page 484</a> .
Periodic AP Snapshot Interval	Set the interval in minutes at which to generate a periodic snapshot of monitored APs. The (AMON) messages comprising the snapshot will be spread over this interval.
Periodic Rogue AP Snapshot Interval	Set the interval in minutes at which to generate a periodic snapshot of monitored Rogue APs. The (AMON) messages comprising the snapshot will be spread over this interval.
Periodic STA Snapshot Interval	Set the interval in minutes at which to generate a periodic snapshot of monitored clients. The (AMON) messages comprising the snapshot will be spread over this interval.
System Wired MAC Update Interval	Set the interval, in minutes, for repopulating the system wired MAC table at the managed device.

## Configuring Local WMS Settings In the CLI

Use the following command to configure local WMS settings via the **ids wms-local-system-profile**. The parameters in this command are described in detail in [Table 96](#).

```
(host) [mynode] (config) #ids wms-local-system-profile
```

## Mobility Master WMS Termination vs. Managed Device WMS Termination

By default, the devices and events detected by a managed device are sent to Mobility Master, allowing Mobility Master to update its database with AP, client, and event information from that managed device. This is the recommended mode for terminating WMS services.

If a managed device is installed at a location with strict bandwidth limitations, the WMS services can optionally be configured to terminate at the managed device. Local managed device termination of WMS services must be enabled with caution. Enabling this feature reduces the bandwidth used by messages between the managed device and Mobility Master, but does introduce some serious limitations. Optimal device classification and IDS detection/protection requires a centralized network-wide view that is best provided by WMS termination on Mobility Master.




---

Enable local (managed device) termination of the WMS service with caution, as enabling this feature may impact WMS device classification and IDS detection and protection on your network. **This feature is only supported on a network topology where the managed device is geographically away from another managed device terminating APs.**

---

## AMON Messaging between WMS on a Managed Device and WMS on Mobility Master

If you enable local termination of the WMS service on a managed device, the default behavior for this feature prevents Mobility Master from monitoring devices seen by APs on that managed device. As a result, network administrators must view these devices via the managed device WebUI and command-line interfaces. This is the recommended method for monitoring devices at locations where a managed device locally terminates the WMS service.

However, a managed device can optionally be configured to send AMON messages with information about monitored devices and events to the WMS service on Mobility Master. The managed device does not send AMON messages to Mobility Master unless AMON messaging is enabled via Mobility Master WebUI.



---

**Do not enable WMS AMON messages from a managed device to Mobility Master if the WMS service does not terminate on the managed device, as this will disrupt WMS functionality for the APs associated to that managed device.** AMON messages sent from a managed device to Mobility Master are likely to consume a substantial amount of bandwidth, potentially eliminating and bandwidth savings provided by local termination of WMS on a managed device.

---

To allow a managed device that is locally terminating the WMS service to send AMON messages to Mobility Master:

1. In the **Mobility Master** node hierarchy, navigate to **Configuration > System > More > General** page and configure the Mobility Master as management server for the managed device.
2. Enable AMON messaging from the managed device to Mobility Master using the **Mgmt Config** profile in **Controller Profile** under the **Configuration > System > Profiles** page of the Mobility Master WebUI.

### Supported AMON Message Types

A managed device terminating the WMS service can send the following AMON message types to Mobility Master:

- **Monitored AP Info Messages:** This message is sent when a monitored AP is newly added to the WMS, or a monitored AP's classification, confidence level, SSID, or encryption type has changed. To enable this message type, select the **Monitored Info - Add/Update** option in the **Mgmt Config** profile.
- **Monitored AP Delete Messages:** This message is not used by WMS. Although this message type can be enabled via the **Monitored Info - Deletion** option in the **Mgmt Config** profile, best practices is to keep this option disabled.
- **Monitored Station Info Messages:** This message is sent when a monitored client is newly added to the WMS, or a monitored client's BSSID or rogue station type has changed. To enable this message type, select the **Monitored Info - Add/Update** option in the **Mgmt Config** profile.
- **Monitored Station Delete Messages:** This message is not used by WMS. Although this message type can be enabled via the **Monitored Info - Deletion** option in the **Mgmt Config** profile, best practices is to keep this option disabled.
- **Rogue AP Info Messages:** This message is sent when an AP is newly classified as a rogue or suspected Rogue, or when the AP confidence level changes. To enable this message type, select the **Monitored Info - Add/Update** option in the **Mgmt Config** profile.
- **Wireless IDS Event Info Message:** (new): This message type sends information about Intrusion Detection System events as they are seen. To enable this message type, select the **Wireless IDS Event Info** option in the **Mgmt Config** profile.
- **Periodic AP Snapshots:** This message type sends a snapshot of all monitored APs in WMS every update period. To enable this message type, select the **Monitored Info - Periodic Snapshot** option in the **Mgmt Config** profile. Use the **Periodic STA Snapshot Interval** parameter in the IDS WMS Local System profile to set the interval during which the AP snapshot messages are sent.
- **Periodic Station Snapshots:** This message type sends a snapshot of all monitored clients in WMS every update period. To enable this message type, select the **Monitored Info - Periodic Snapshot** option in the **Mgmt Config** profile. Use the **Periodic Rogue AP Snapshot Interval** parameter in the IDS WMS Local System profile to set the interval during which the client snapshot messages are sent.
- **Periodic Rogue AP Snapshots:** This message type sends a snapshot of all rogue APs in WMS every update period. To enable this message type, select the **Monitored Info - Periodic Snapshot** option in the **Mgmt**

**Config** profile. Use the **Periodic AP Snapshot Interval** parameter in the IDS WMS Local System profile to set the interval during which the rogue AP snapshot messages are sent.

## Managing the WMS Database

The WMS process interacts with all the air monitor (AM) processes in the network. When WMS receives an event message from an AM, the WMS process will save the event information along with the BSSID of the AP that generated the event in the WMS database. Use the following commands in Enable mode to manage the WMS database.

The **wms export-db** command exports the specified file as an ASCII text file into the WMS database.

```
(host) [mynode] #wms export-db <filename>
```

The **wms import-db** command imports the specified file into the WMS database:

```
(host) [mynode] #wms import-db <filename>
```

The **wms reint-db** command reinitializes the WMS database. Note that this command does not make an automatic backup of the current database.

```
(host) [mynode] #wms reint-db
```

## Optimizing Classification Behavior

APs can be configured to periodically send WMS a list of monitored devices that are still unclassified. Once the WMS receives this list, a classification message is sent from the WMS to the AP, to classify each unclassified device.

### In the WebUI

1. In the **Managed Network** node hierarchy, navigate to **Configuration > System > Profiles**.
2. Expand the **IDS** menu and select **IDS General**.
3. Expand the **Advanced** accordion.
4. Configure the parameters as described in [Table 97](#) then click **Save**.
5. Click **Pending Changes**.
6. In the **Pending Changes** window, select the check box and click **Deploy changes**.

**Table 97:** *IDS General Profile Parameters*

Parameter	Description
Unclassified AP Update	Enables or disables classification updates for monitored APs. If this option is enabled, it helps decrease the delay in the speed at which the devices are classified.  Default: Disabled
Unclassified STA Update	Enables or disables classification updates for monitored clients. If this option is enabled, it helps decrease the delay in the speed at which the devices are classified.  Default: Disabled

### In the CLI

Use the following command to configure IDS General Profile parameters using the CLI.

```
(host) [md] (config) # ids general-profile <profile-name>  
(host) [md] (IDS General Profile "<profile-name>") #unclass-ap-update  
(host) [md] (IDS General Profile "<profile-name>") unclass-device-update-interval
```

```
(host) [md] (IDS General Profile "<profile-name>")unclass-sta-update
```

## Managing the List of Valid Exempt Clients

The network administrator can configure clients to be exempted from valid station protection and valid station misassociation detection by adding the mac-address of those devices to the valid-exempt-list.

Once a client MAC address is added to the valid-exempt list:

- If the client exists in the WMS, the classification is set to valid.
- If the client does not exist in the WMS, a client entry is created and then the classification is set to valid.
- After the classification is done, APs that are seeing the client are notified that the client is added to the valid-exempt list.



---

A maximum of 200 MAC addresses can be added to a valid-exempt list. The valid-exempt list is not retained after the managed device reboots or a process is restarted.

---

### In the CLI

Use the following commands to add or remove MAC addresses from the valid-exempt list:

```
(host) [md] (config) #wms client <macaddr> valid-exempt insert
(host) [md] (config) #wms client <macaddr> valid-exempt remove
```

Use the following command to display a list of configured valid-exempt clients:

```
(host) [md] #show wms client valid-exempt
```

Use the following command to display a list of clients that are viewed by the AP and marked as valid-exempt:

```
(host) [md] #show ap monitor client-list ap-name <> valid-exempt
```

Use the following command to view the number of MAC addresses added to the valid-exempt client list:

```
(host) [md] #show wms counters
Counters
-----
Name                               Value
----                               -
DB Reads                           288268
DB Writes                           350870
Probe Table DB Reads                2477
Probe Table DB Writes               952
AP Table DB Reads                   143992
AP Table DB Writes                  138867
STA Table DB Reads                   40404
STA Table DB Writes                 99687
Probe STA Table DB Reads            101352
Probe STA Table DB Writes          117566
Probe Register                       2476
Probe State Update                   37077
Set RAP Type                         42552
Set RAP Type Conf Level              152
Valid Exempt Station Macs       10
```

## Understanding Client Blacklisting

When a client is blacklisted in the Aruba system, the client is not allowed to associate with any AP in the network for a specified amount of time. If a client is connected to the network when it is blacklisted, a deauthentication message is sent to force the client to disconnect. While blacklisted, the client cannot associate with another SSID in the network.

The managed device retains the client blacklist in the user database, so the information is not lost if the managed device reboots. When you import or export the managed device's user database, the client blacklist will be exported or imported as well.

## Methods of Blacklisting

There are several ways in which a client can be blacklisted in the Aruba system:

- You can manually blacklist a specific client. See [Blacklisting Manually on page 488](#) for more information.
- A client fails to successfully authenticate for a configured number of times for a specified authentication method. The client is automatically blacklisted. See [Blacklisting by Authentication Failure on page 488](#) for more information.
- A DoS or man in the middle (MITM) attack has been launched in the network. Detection of these attacks can cause the immediate blacklisting of a client. See [Enabling Attack Blacklisting on page 489](#) for more information.
- An external application or appliance that provides network services, such as virus protection or intrusion detection, can blacklist a client and send the blacklisting information to the Mobility Master via an XML API server. When the managed device receives the client blacklist request from the server, it blacklists the client, logs an event, and sends an SNMP trap.

See [External Services Interface on page 998](#) for more information.



---

The External Services Interface feature requires the Policy Enforcement Firewall Next Generation (PEFNG) license installed in the managed device.

---

## Blacklisting Manually

There are several reasons why you may choose to blacklist a client. For example, you can enable different Aruba intrusion detection system (IDS) features that detect suspicious activities, such as MAC address spoofing or DoS attacks. When these activities are detected, an event is logged and an SNMP trap is sent with the client information. To blacklist a client, you need to know its MAC address.

To manually blacklist a client, issue the following command in enable mode of the CLI:

```
(host) [md] #stm add-blacklist-client
```

To clear the entire client blacklist, issue the following command in enable mode of the CLI:

```
(host) [md] #stm purge-blacklist-clients
```

## Blacklisting by Authentication Failure

You can configure a maximum authentication failure threshold for each of the following authentication methods:

- 802.1X
- MAC
- Captive portal
- VPN

When a client exceeds the configured threshold for one of the above methods, the client is automatically blacklisted by the managed device, an event is logged, and an SNMP trap is sent. By default, the maximum authentication failure threshold is set to 0 for the above authentication methods, which means that there is no limit to the number of times a client can attempt to authenticate.

With 802.1X authentication, you can also configure blacklisting of clients who fail machine authentication.





---

When clients are blacklisted because they exceed the authentication failure threshold, they are blacklisted indefinitely by default. You can configure the duration of the blacklisting; see [Setting Blacklist Duration on page 489](#).

---

To set the authentication failure threshold via the WebUI:

1. In the **Managed Networks** node hierarchy, navigate to **Configuration > System > Profiles**.
2. In **All Profiles** expand the **Wireless LAN** list, select the appropriate authentication profile, then select the profile instance.
3. Enter a value in the **Max Authentication failures** field.
4. Click **Save**.
5. Click **Pending Changes**.
6. In the **Pending Changes** window, select the check box and click **Deploy changes**.

To set the authentication failure threshold via the command-line interface, access the CLI in config mode and issue the following commands:

```
(host) [md] (config) #aaa authentication {captive-portal|dot1x|mac|vpn} <profile>
(host) [md] (<Auth-Profile> <profile-name>) # max-authentication-failures <number>
```

## Enabling Attack Blacklisting

There are two types of automatic client blacklisting that can be enabled: blacklisting due to spoofed deauthentication, or blacklisting due to other types of DoS attacks.

Automatic blacklisting for DoS attacks other than spoofed deauthentication is enabled by default. You can disable this blacklisting on a per-SSID basis in the virtual AP profile.

Man in the middle (MITM) attacks begin with an intruder impersonating a valid enterprise AP. If an AP needs to reboot, it sends deauthentication packets to connected clients to enable them to disconnect and reassociate with another AP. An intruder or attacker can spoof deauthentication packets, forcing clients to disconnect from the network and reassociate with the attacker's AP. A valid enterprise client associates to the intruder's AP, while the intruder then associates to the enterprise AP. Communication between the network and the client flows through the intruder (the man in the middle), thus allowing the intruder the ability to add, delete, or modify data. When this type of attack is identified by the Aruba system, the client can be blacklisted, blocking the MITM attack. You can enable this blacklisting ability in the **IDS DoSprofile** (this is disabled by default).

To enable spoofed deauth detection and blacklisting via the WebUI:

1. In the **Managed Networks** node hierarchy, navigate to **Configuration > System > Profiles**.
2. In **All Profiles**, expand the **IDS** menu, then select a profile from the **IDS DOS profile** list.
3. Select the **Spoofed Deauth Blacklist** check box.
4. Click **Save**.
5. Click **Pending Changes**.
6. In the **Pending Changes** window, select the check box and click **Deploy changes**.

To enable spoofed deauth detection and blacklisting via the command-line interface, access the CLI in config mode, and issue the following commands:

```
(host) [md] (config) #ids dos-profile defaultids dos-profile <profile>
(host) [md] (IDS Denial Of Service Profile "default") #spoofed-deauth-blacklist
```

## Setting Blacklist Duration

You can configure the duration that clients are blacklisted on a per-SSID basis via the virtual AP profile. There are two different blacklist duration settings:

- For clients that are blacklisted due to authentication failure. By default, this is set to 0 (the client is blacklisted indefinitely).
- For clients that are blacklisted due to other reasons, including manual blacklisting. By default, this is set to 3600 seconds (one hour). You can set this to 0 to blacklist clients indefinitely.

To configure the blacklist duration via the WebUI:

1. In the **Managed Networks** node hierarchy, navigate to the **Configuration >System > Profiles** page.
2. In **All Profiles**, select **Wireless LAN**, then **Virtual AP**. Select the virtual AP instance.
  - a. To set a blacklist duration for authentication failure, expand the **Advanced** accordion and enter a value for **Authentication Failure Blacklist Time**.
  - b. To set a blacklist duration for other reasons, expand the **Advanced** accordion and enter a value for **Blacklist Time**.
3. Click **Save**.
4. Click **Pending Changes**.
5. In the **Pending Changes** window, select the check box and click **Deploy changes**.

To configure the blacklist duration via the command-line interface, access the CLI in config mode and issue the following commands:

```
(host) [md] (config) #wlan virtual-ap default
(host) [md] (Virtual AP profile "default") #auth-failure-blacklist-time <seconds>
(host) [md] (Virtual AP profile "default") #blacklist-time <seconds>
```

## Removing a Client from Blacklisting

To remove a client from blacklisting via the command-line interface, access the CLI in enable mode and issue the following command:

```
(host) [md] #stm remove-blacklist-client <macaddr>
```

## Working with WIP Advanced Features

Device Classification is the first step in securing the corporate environment from unauthorized wireless access. Adequate measures that quickly shut down intrusions are critical in protecting sensitive information and network resources. APs and stations must be accurately classified to determine whether they are valid, rogue, or a neighboring AP. Then, an automated response can be implemented to prevent possible intrusion attempts.

TotalWatch™ allows for detecting devices that are running on typical operational channels. Tarpit Shielding provides a better way of containing devices that are deemed unauthorized. Both of these features are discussed in the sections that follow.

- [Configuring TotalWatch on page 490](#)
- [Administering TotalWatch on page 493](#)
- [Tarpit Shielding Overview on page 494](#)
- [Configuring Tarpit Shielding on page 494](#)

## Configuring TotalWatch

Aruba 802.11n APs and non-11n APs in AM-mode support for TotalWatch is the ability to scan all channels of the RF spectrum, including 2.4- and 5-GHz bands as well as the 4.9-GHz public safety band. TotalWatch also provides 5-MHz granular channel scanning of bands for rogue devices and dynamic scanning dwell times to focus on those channels with traffic. TotalWatch provides an advanced set of features to detect unauthorized

wireless devices and a set of customized rules are used to highlight devices that truly pose a threat to the network.



---

TotalWatch is supported on APs deployed in the AM-mode only.

---

TotalWatch provides monitoring support for the entire WLAN spectrum. Aruba APs in the AM-mode can *monitor* the following frequencies:

- 2412MHz to 2472MHz in the 2.5GHz band
- 5100Mhz to 5895MHz in the 5GHz band.

Aruba APs in AM-mode can *scan* the following additional frequencies:

- 2484MHz and 4900Mhz to 5000MHz (J-channels)
- 5000 to 5100MHz

If the AP is HT-capable (High Throughput), these frequencies are scanned in the 40MHz mode.

## Understanding TotalWatch Channel Types and Qualifiers

Based on the regulatory characteristics, channels are categorized into the following types:

- **Reg-domain Channels** : A channel that belongs to the regulatory domain of the country in which the AP is deployed. The set of channels that belong to this group is a subset of the channels in the all-reg-domain channel group.
- **All-reg-domain Channels** : A valid non-overlapping channel that is in the regulatory domain of at least one country. The channels in this category belong in the frequency ranges of:
  - 2412MHz to 2472MHz in the g-band
  - 5100Mhz to 5895MHz in the a-band.
- **Rare Channel** : Channels that fall into a frequency range outside of the regulatory domain; 2484 MHz and 4900MHz-4995MHz (J-channels), and 5000-5100Mhz. The channels in this group do not belong to any other group.

Each of these channel types can have an associated qualifier:

- **Active Channel** : This qualifier indicates that wireless activity is detected on this channel by the presence of an AP or other 802.11 activity such as a probe request.
- **DOS Channel** : A channel where wireless containment is active. This channel should belong to the country-code channel (regulatory domain).

## Understanding TotalWatch Monitoring Features

TotalWatch enables monitoring of all channels including regulatory domain and rare channels. You can select one of the following scanning modes for each radio AP:

- scan only the channels that belong to the AP's regulatory domain
- scan channels that belong to all regulatory domains
- scan all channels

## Understanding TotalWatch Scanning Spectrum Features

TotalWatch scans the following frequencies.

- G-band—2412MHz to 2472MHz
- J-band—2484 MHz and 4900-4995MHz

- A-band—5000-5100MHz to 5895MHz

[Table 98](#) list the frequency-to-channel mapping used by TotalWatch.

**Table 98:** *Frequency to Channel Mapping*

Frequency	Channel
2412 – 2472MHz (in increments of 5MHz)	1 - 13
2484MHz	14
5100 – 5895MHz (in increments of 5MHz)	20 - 179
4900 – 4995MHz (in increments of 5MHz)	180 - 199
5000 – 5100MHz	200 - 219

## Understanding TotalWatch Channel Dwell Time

When an AP (in am-mode) visits a channel, the amount of time the AP *stays* on that channel is known as the *dwell time*. The channel dwell time is a variable value based on the following channel types.

- **dwell-time-active-channel** : For channels where there is wireless activity. Default setting is 500 ms.
- **dwell-time-reg-domain channel** : For channels that belong to the AP's regulatory domain group (reg-domain) with *no* wireless activity. The default setting is 250 ms.
- **dwell-time-other-reg-domain-channel** : For channels that belong to the *all* regulatory domain group (all-reg-domain) with *no* wireless activity The default setting is 250 ms.
- **dwell-time-rare-channel** : For channels in the rare group where *no* wireless activity is detected. The default value is 100 ms.

Use the **rf am-scan-profile** command to set the dwell time and scan mode.

## Understanding TotalWatch Channel Visiting

The Active and DOS channels are visited more frequently than the other channels. The order of preference in selecting the next channel is:

1. DOS
2. Active
3. reg-domain
4. All-reg-domain
5. Rare

Once a channel is selected, the dwell time for that channel is determined based on the channel type. At the end of the dwell time, a new channel is picked.

## Understanding TotalWatch Age out of Devices

ArubaOS uses a combination of inactivity time and unseen time to age out a device. This ensures that the channel is scanned a sufficient number of times before a device ages out. AM module maintains the following

parameters:

- **Discovered Time** : The absolute time, in seconds, since the device was discovered.
- **Monitored Time** : The number of times the channel was scanned since discovery.
- **Inactivity Time** : The number of times the device was not “seen” when the channel is scanned.
- **Unseen Time** : The absolute time, in seconds, since the device was last “seen.”

## Administering TotalWatch

The AM module will initialize the channel list for each of the AP’s radio based on the scan mode setting for the radio. For example, if scan mode is set to rare, then the channel list will contain all possible channels. You can view these channels by using the **show ap arm scan-times** command.

### Configuring Per Radio Settings

For each radio, you can configure the following settings (for detailed information on commands, refer to the *ArubaOS 8.0.1.0 Command Line Reference Guide*):

- the dwell times for the various channel types
- the channel list that should be used for scanning

These settings are configured via the command **rfam-scan-profile**, which can be attached to the two profiles, **dot11a-radio-profile** and **dot11g-radio-profile**.

The am-scan-profile includes the following parameters that can be configured:

```
rf am-scan-profile <name>
scan-mode [reg-domain | all-reg-domain | rare]
```

The default setting is the all-reg-domain. This is consistent with the default functioning of the AM scanning where the radio scans channels belonging to all regulatory domains.

### Configuring Per AP Setting

If the AP is a dual-band single radio AP, an option is available to specify which band should be used for scanning in AM-mode. This setting is available in the **ap system-profile**, via the **am-scan-rf-band** command.

```
ap system-profile <name>
am-scan-rf-band [a | g | all]
```

The default value is “all”, which is consistent with the prior behavior. This setting is ignored in the case of a dual radio AP.

There are four parameters that controls the age out of devices in the AM module.

```
ids general-profile <name>
ap-inactivity-timeout
sta-inactivity-timeout
ap-max-unseen-timeout
sta-max-unseen-timeout
```

The inactivity timeout is the number of times the device was not “seen” when the channel was scanned. The unseen timeout is the time, in seconds, since the device was last “seen.”

The **show ap monitor scan-info/channel** commands provide details of the channel types, dwell times, and the channel visit sequence.

```
(host) # show ap monitor scan-info ap-name rb-121
```

## Licensing

The ability to perform rare scanning is available only with the RFprotect license. However, the AP can scan **reg-domain** or **all-reg-domain** channels without the RFprotect license.

## Tarpit Shielding Overview

The Tarpit Shielding feature is a type of wireless containment. Detected devices that are classified as rogues are contained by forcing client association to a fake channel or BSSID. This method of tarpitting is more efficient than rogue containment via repeated de-authorization requests. Tarpit Shielding works by spoofing frames from an AP to *confuse* a client about its association. The *confused* client assumes it is associated to the AP on a different (fake) channel than the channel that the AP is actually operating on, and will attempt to communicate with the AP in the fake channel.

Tarpit Shielding works in conjunction with the *death* wireless containment mechanism. The death mechanism triggers the client to generate probe request and subsequent association request frames. The AP then responds with probe response and association response frames. Once the monitoring AP sees these frames, it will spoof the probe-response and association response frames, and manipulates the content of the frames to confuse the client.

A station is determined to be in the Tarpit when we see it sending data frames in the fake channel. With some clients, the station remains in tarpit state until the user manually disables and re-enables the wireless interface.

## Configuring Tarpit Shielding

Tarpit shielding is configured on an AP using one of two methods:

- **Disable all clients** : In this method, any client that attempts to associate with an AP marked for containment is sent spoofed frames.
- **Disable non-valid clients** : In this method, only non-authorized clients that attempt to associate with an AP are sent to the tarpit.

The choices for disabling Tarpit Shielding on an AP are:

- Death-wireless-containment
- Death-wireless-containment with tarpit-shielding (excluding-valid-clients)
- Death-wireless-containment with tarpit-shielding

## Enabling Tarpit Shielding

Use the **ids-general-profile** command to configure **Tarpit Shielding** (for detailed information on commands refer to the *ArubaOS Command Line Reference Guide*).

```
(host) [mynode] (config) #ids general-profile default
```

```
(host) [mynode] (IDS General Profile "default") #wireless-containment [death-only | none | tarpit-all-sta | tarpit-non-valid-sta]
```

Use the following show commands to view updated Tarpit Shielding status and the spoofed frames generated for an AP:

- **show ap monitor stats**
- **show ap monitor containment-info**

## Understanding Tarpit Shielding Licensing CLI Commands

Under the **ids general-profile default wireless-containment** command, the **tarpit-non-valid-sta** and **tarpit-all-sta** options are available only with a RFprotect license. The **deauth-only** and **none** options are available with the Base OS license.

When an AP is first installed on the network and powered on, the AP locates its host managed device and the AP's designated configuration is "pushed" from the Mobility Master to the AP. This chapter gives an overview of the basic functions of each AP, and describes the process to install and configure the APs on your network.



---

APs cannot terminate either on Mobility Master or a master controller. They must terminate on managed devices only.

---

The following topics are included in this chapter:

- [Basic Functions and Features on page 496](#)
- [AP Settings Triggering a Radio Restart on page 497](#)
- [Naming and Grouping APs](#)
- [Understanding AP Configuration Profiles on page 502](#)
- [Before you Deploy an AP on page 504](#)
- [Enable Controller Discovery on page 504](#)
- [Enable DHCP to Provide APs with IP Addresses](#)
- [Enable Controller Discovery on page 504](#)
- [Configuring Installed APs on page 509](#)
- [Optional AP Configuration Settings on page 516](#)
- [Configuring AP Image Preload on page 514](#)
- [2.4 Ghz and 5 Ghz Radio RF Management on page 530](#)
- [Validating and Optimizing AP Connectivity on page 542](#)
- [AP Chanel Scanning on page 543](#)
- [Managing AP Console Settings on page 545](#)
- [Link Aggregation Support on page 549](#)
- [Support for Port Bounce on page 552](#)

## Basic Functions and Features

Use the Mobility Master WebUI and command-line interface to configure APs. [Table 99](#) lists the basic AP configuration functions and features.



**Table 99: AP Configuration Function Overview**

Features and Function	Description
Wireless LANs	<p>A wireless LAN (WLAN) permits wireless clients to connect to the network. An AP broadcasts the SSID (which corresponds to a WLAN configured on the Mobility Master) to wireless clients. APs support multiple SSIDs. WLAN configuration includes the authentication method and the authentication servers by which wireless users are validated for access.</p> <p>The WebUI includes a WLAN Wizard that provides easy-to-follow steps to configure a new WLAN.</p> <p><b>NOTE:</b> All new WLANs are associated with the ap-group named “default”.</p>
AP operation	<p>An AP can function as an AP that serves clients, as an air monitor (AM) performing network and radio frequency (RF) monitoring, or as a hybrid AP that serves both clients and performs spectrum analysis a single radio channel. You can also specify the regulatory domain (the country) which determines the 802.11 transmission spectrum in which the AP will operate. Within the regulated transmission spectrum, you can configure 802.11a, 802.11b/g, or 802.11n (high-throughput) radio settings.</p> <p><b>NOTE:</b> The 802.11n features, such as high-throughput and 40 MHz configuration settings, are supported on APs that are 802.11n standard compliant.</p>
Quality of Service (QoS)	<p>Configure Voice over IP call admission control options and bandwidth allocation for 5 GHz (802.11a) or 2.4 GHz (802.11b/g) frequency bands of traffic.</p>
RF Management	<p>Configure settings for balancing wireless traffic across APs, detect holes in radio coverage, or other metrics that can indicate interference and potential problems on the wireless network.</p> <p>Adaptive Radio Management (ARM) is an RF spectrum management technology that allows each AP to determine the best 802.11 channel and transmit power settings. ARM provides several configurable settings.</p>
Intrusion Detection System	<p>Configure settings to detect and disable rogue APs, adhoc networks, and unauthorized devices, and prevent attacks on the network. You can also configure signatures to detect and prevent intrusions and attacks.</p>
Mesh	<p>Configure Aruba APs as mesh nodes to bridge multiple Ethernet LANs or extend wireless coverage. A mesh node is either</p> <ul style="list-style-type: none"> <li>• a mesh portal: an AP that uses its wired interface to reach the managed device</li> <li>• a mesh point: an AP that establishes a path to the managed device via the mesh portal</li> </ul> <p>Mesh environments use a wireless backhaul to carry traffic between mesh nodes. This allows one 802.11 radio to carry traditional WLAN services to clients and one 802.11 radio to carry mesh traffic and WLAN services. <a href="#">Secure Enterprise Mesh on page 553</a> contains more specific information on the Mesh feature.</p>

## AP Settings Triggering a Radio Restart

Changing the following settings triggers the radio to restart on the 200 Series, AP-205H, 210 Series, 220 Series, 270 Series and 320 Series access points. When the radio restarts, wireless services will be briefly interrupted. Clients will automatically reconnect to the network when the radio is again up and running.

**Table 100:** Profile Settings that restart an AP radio

Profile	Settings
802.11a/802.11g Radio Profile	<ul style="list-style-type: none"><li>● Channel</li><li>● Enable Channel Switch Announcement (CSA)</li><li>● CSA Count</li><li>● High throughput enable (radio)</li><li>● Very high throughput enable (radio)</li><li>● TurboQAM enable</li><li>● Maximum distance (outdoor mesh setting)</li><li>● Transmit EIRP</li><li>● Advertise 802.11h Capabilities</li><li>● Beacon Period/Beacon Regulate</li><li>● Advertise 802.11d Capabilities</li></ul>
Virtual AP Profile	<ul style="list-style-type: none"><li>● Virtual AP enable</li><li>● Forward Mode</li><li>● Remote-AP operation</li></ul>
SSID Profile	<ul style="list-style-type: none"><li>● ESSID</li><li>● Encryption</li><li>● Enable Management Frame Protection</li><li>● Require Management Frame Protection</li><li>● Multiple Tx Replay Counters</li><li>● Strict Spectralink Voice Protocol (SVP)</li><li>● Wireless Multimedia (WMM) settings<ul style="list-style-type: none"><li>■ Wireless Multimedia (WMM)</li><li>■ Wireless Multimedia U-APSD (WMM-UAPSD) Powersave</li><li>■ WMM TSPEC Min Inactivity Interval</li><li>■ DSCP mapping for WMM voice AC</li><li>■ DSCP mapping for WMM video AC</li><li>■ DSCP mapping for WMM best-effort AC</li><li>■ DSCP mapping for WMM background AC</li></ul></li></ul>

**Table 100:** Profile Settings that restart an AP radio

Profile	Settings
High-throughput SSID Profile	<ul style="list-style-type: none"><li>• High throughput enable (SSID)</li><li>• 40 MHz channel usage</li><li>• Very High throughput enable (SSID)</li><li>• 80 MHz channel usage (VHT)</li></ul>
802.11r Profile	<ul style="list-style-type: none"><li>• Advertise 802.11r Capability</li><li>• 802.11r Mobility Domain ID</li><li>• 802.11r R1 Key Duration</li><li>• key-assignment (CLI only)</li></ul>
Hotspot 2.0 Profile	<ul style="list-style-type: none"><li>• Advertise Hotspot 2.0 Capability</li><li>• RADIUS Chargeable User Identity (RFC4372)</li><li>• RADIUS Location Data (RFC5580)</li></ul>

## Naming and Grouping APs

In the Aruba user-centric network, each AP has a unique name and belongs to an AP group.

Each AP is identified with an automatically-derived name. The default name depends on if the AP has been previously configured.

- The AP has not been configured—the name is the AP's Ethernet MAC address in colon-separated hexadecimal digits.
- Configured with a previous ArubaOS release—the name is in the format *building.floor.location*

You can assign a new name (up to 63 characters) to an AP; the new name must be unique within your network. For example, you can rename an AP to reflect its physical location within your network, such as “building3-lobby”.

An *AP group* is a set of APs to which the same configuration is applied. There is an AP group called “default” to which all APs discovered by the managed device are assigned. By using the “default” AP group, you can configure features that are applied globally to all APs.

You can create additional AP groups and assign APs to that new group. However, an AP can belong to only one AP group at a time. For example, you can create an AP group “Victoria” that consists of the APs that are installed in a company's location in British Columbia. You can create another AP group “Toronto” that consists of the APs in Ontario. You can configure the “Toronto” AP group with different information from the APs in the “Victoria” AP group.

While you can use an AP group to apply a feature to a set of APs, you can also configure a feature or option for a specific AP by referencing the AP's name. Any options or values that you configure for a specific AP will override the same options or values configured for the AP group to which the AP belongs.

The following procedures describes how to create an AP group.



---

Reassigning an AP from an AP group requires a reboot of the AP for the new group assignment to take effect. Therefore, wait until there is little or no client traffic passing through the AP before reassigning it.

---

## Creating an AP group

You can use the WebUI or the CLI to create a new AP group.

### In the WebUI

1. In the **Managed Network** node hierarchy, select the managed device where the AP group are to be added.
2. Navigate to the **Configuration > AP Groups** menu.
3. Click **Add** below the AP Groups table.
4. In the **New AP Groups** window, enter the AP group name in the **New AP groups** field.
5. Click **Submit**.
6. Click **Pending Changes**.
7. In the **Pending Changes** window, select the check box and click **Deploy Changes**.

### In the CLI

Use the following command to create an AP group:

```
(host) [mynode] (config) #ap-group <group>
```

When you create an AP group with the CLI, you can specify the virtual AP definitions and configuration profiles you want applied to the APs in the group.

## Assigning an AP to an AP Group

Although you will assign an AP to an AP group when you first deploy the device, you can assign an AP to a different AP group at any time.



---

Once the **ap-regroup** command is executed, the AP automatically reboots. If the AP is powered off or otherwise not connected to the network or managed device, the executed command is queued until the AP is powered on or reconnected.

---

### In the WebUI

1. In the **Managed Network** node hierarchy, navigate to the **Configuration > Access Points** menu.
2. Select the check box next to the AP and click **Provision**.
3. From the list of provisioning settings, click the **AP group** drop-down list and choose a new the AP group for the selected AP.
4. Click **Submit**.
5. Click **Pending Changes**.
6. In the **Pending Changes** window, select the check box and click **Deploy Changes**.

### In the CLI

Use the following command to assign a single AP to an existing AP group.

```
(host) [mynode] (config) #ap-regroup {ap-name <name>|serial-num <number>|wired-mac <macaddr>} <group>
```

## Assigning Channels to an AP Group

The country code in the AP Regulatory Domain profile determines supported channel and channel pairs for that specific AP. Any changes to the country code causes the valid channel lists to be reset to the defaults for the country.

This section illustrates how to perform the following tasks for an AP group:

- Configure the “default” regulatory domain profile to use a valid country code. This will determine the available channels.
- Configure a 40 MHz channel (bonded pair) for the AP group’s 802.11a (5 GHz) radio profile.
- Configure a 20 MHz channel for the AP group’s 802.11g (2.4 GHz) radio profile.

## Using the WebUI

1. In the **Managed Network** node hierarchy, select the managed device containing the AP group.
2. Navigate to the **Configuration > AP Groups** page.
3. Select the AP group to be configured.
4. Select the **Radio** tab from the AP group menu and click **Basic** accordion.
5. Click the **Radio mode** drop-down list and choose **ap-mode**.
6. Select 2.4 GHz or 5 GHz radio to be configured and click **Edit** in the **Valid Channels** field.
7. In the **Valid Channels** window, select the channels that will be supported by the AP group.
8. Click **OK**.
9. Click **Submit**.
10. Click **Pending Changes**.
11. In the **Pending Changes** window, select the check box and click **Deploy Changes**.

## Using the CLI

The following commands may be used to configure channels for an AP group.

```
(host) [mynode] (config) #ap regulatory-domain-profile default
country-code US
(host) [mynode] (config) #rf dot11a-radio-profile ht-corpnet-a
channel 36+
(host) [mynode] (config) #rf dot11g-radio-profile ht-corpnet-g
channel 1
```




---

Country codes are generally specified in ISO 3166 format. To see what channels are available for a given country code, use the **show ap allowed-channels country-code <country-code>** command.

---

## Channel Switch Announcement (CSA)

When an AP changes its channel, an existing wireless clients may “time out” while waiting to receive a new beacon from the AP; the client must begin scanning to discover the new channel on which the AP is operating. If the disruption is long enough, the client may need to reassociate, reauthenticate, and request an IP address. Channel Switch Announcement (CSA), as defined by IEEE 802.11h, enables an AP to announce that it is switching to a new channel before it begins transmitting on that channel. This allows the clients, who support CSA, to transition to the new channel with minimal downtime.

When CSA is enabled, the AP does not change to a new channel immediately. Instead, it sends a number of beacons (the default is 4) which contain the CSA announcement before it switches to the new channel. You can configure the number of announcements sent before the change.




---

Clients must support CSA in order to track the channel change without experiencing disruption.

---

## Using the WebUI

1. In the **Managed Network** node hierarchy, select the managed device containing the AP group.
2. Navigate to the **Configuration > AP Groups** page.
3. Select the AP group to be configured.

4. Select **Radio** tab from the AP group menu and click **Advanced** accordion.
5. Select **Enabled** from the **CSA** drop-down list. This option can be enabled/disabled separately for 2.4 GHz and 5 GHz radios.
6. Click **Submit**.
7. Click **Pending Changes**.
8. In the **Pending Changes** window, select the check box and click **Deploy Changes**.

## Automatic Channel and Transmit Power Selection

To allow automatic channel and transmit power selection based on the radio environment, enable Adaptive Radio Management (ARM). Note that ARM assignments will override the static channel and power configurations done using the radio profile. For complete information on the Adaptive Radio Management feature, refer to [RF Planning and Channel Management on page 439](#).

## Understanding AP Configuration Profiles

An AP configuration profile is a general name to describe any of the different groups of settings that can be defined, saved, and applied to an Access Point. ArubaOS has many different types of profiles that each allow you to configure a different aspect of an AP's overall configuration. ArubaOS also contains a predefined "default" profile for each profile type. You can use the predefined settings in these default profiles, or create entirely new profiles that you can edit as required.

Each different AP configuration profile type can be managed using the CLI or the WebUI. To see a full list of available configuration profiles using the command-line interface, access the CLI and issue the command **show profile-hierarchy**. To view available configuration profiles using the WebUI, navigate to **Configuration > System**, then select the **Profiles** tab.



---

The profile types that appear in the **All Profiles** list may vary, depending upon the controller configuration and available licenses.

---

## AP Profiles

The AP profiles configure AP operation parameters, radio settings, port operations, regulatory domain, and SNMP information.

- **AM Filter:** Clients may assign APs/AP groups to Air Monitor (AM) filter profiles. These profiles collect data that is used to identify and monitor APs, wireless clients, and mesh nodes within the network.
- **AP Authorization:** Allows you to assign an to a provisioned but unauthorized AP to a AP group with a restricted configuration profile. For details see [Configuring Remote AP Authorization Profiles on page 666](#).
- **AP Ethernet Link:** Sets the duplex mode and speed of the AP's Ethernet link. The configurable speed is dependent on the port type, and you can define a separate Ethernet Interface profile for each Ethernet link. For details on configuring this profile, see [Ethernet Interface Link Profile Parameters on page 519](#)
- **AP LACP LMS map information:** maps a LMS IP address to a GRE striping IP address. If the AP fails over to a standby or backup Mobility Master, the AP LACP LMS map information profile on the new LC defines the striping IP address that the AP uses for link aggregation. For details, see [Configuring LACP](#).
- **AP LLDP and AP LLDP-MED Network Policy:** Link Layer Discovery Protocol (LLDP), is a Layer-2 protocol that allows network devices to advertise their identity and capabilities on a LAN. The LLDP-MED Network Policy profile defines the VLAN, priority levels, and DSCP values used by a voice or video application. Wired interfaces on Aruba APs support LLDP by periodically transmitting LLDP Protocol Data Units (PDUs) comprised of selected type-length-value (TLV) elements. The AP LLDP profile identifies which TLVs will be sent by the AP. For details, see [Understanding Extended Voice and Video Features on page 931](#).

- **AP multizone:** The MultiZone feature allows AP to terminate to multiple managed devices that reside in different zones. A zone is a collection of managed devices under a single administration domain. For details, see [MultiZone](#)
- **AP system:** defines administrative options for the controller, including the IP addresses of the local, backup, and master controllers, Real-time Locating Systems (RTLS) server values and the number of consecutive missed heartbeats on a GRE tunnel before an AP reboots. For details on configuring this profile, see [Optional AP Configuration Settings](#).
- **AP Wired Port:** specifies a AAA profile for users connected to the wired port on an AP.
- **EDCA Parameters (AP):** AP to client traffic prioritization, including EDCA parameters for background, best-effort, voice and video queues. For additional information on configuring this profile, see [Configure EDCA parameters on page 888](#).
- **EDCA Parameters (Station):** client to AP traffic prioritization parameters, including Enhanced Distributed Channel Access (EDCA) parameters for background, best-effort, voice and video queues. For additional information on configuring this profile, see [Configure EDCA parameters on page 888](#).
- **Regulatory Domain:** defines the AP's country code and valid channels for both legacy and high-throughput 802.11a and 802.11b/g radios.
- **Spectrum Local Override:** configure an individual AP radio as a spectrum monitor, For details, see [Converting AP to Spectrum Monitor on page 694](#).
- **Wired AP:** determines if 802.11 frames are tunneled to the controller using Generic Routing Encapsulation (GRE) tunnels, bridged into the local Ethernet LAN, or configured for a combination of the two (split-mode). In tunnel forwarding mode, the AP handles all 802.11 association requests and responses, but sends all 802.11 data packets, action frames and EAPOL frames over a GRE tunnel to the controller for processing. When a remote AP or campus AP is in bridge mode, the AP handles all 802.11 association requests and responses, encryption/decryption processes, and firewall enforcement. In split-tunnel mode, 802.11 frames are either tunneled or bridged, depending on the destination (corporate traffic goes to the controller, and Internet access remains local). For details, see [Configuring Ethernet Ports for Mesh on page 582](#)

## RF Management Profiles

The profiles configure radio tuning and calibration, AP load balancing, and RSSI metrics.

- **802.11a:** defines AP radio settings for the 5 GHz frequency band, including the Adaptive Radio Management (ARM) profile and the high-throughput (802.11n) radio profile. For additional information on configuring this profile, see [2.4 Ghz and 5 Ghz Radio RF Management on page 530](#).
- **802.11g:** defines AP radio settings for the 2.4 GHz frequency band, including the Adaptive Radio Management (ARM) profile and the high-throughput (802.11n) radio profile. Each 802.11a and 802.11b radio profile includes a reference to an Adaptive Radio Management (ARM) profile.

If you want ARM to dynamically select the best channel and transmission power for the radio, verify that the 802.11a/802.11g radio profile references an active and enabled ARM profile. If you want to manually select a channel for each AP group, create separate 802.11a and 802.11g profiles for each AP group and assign a different transmission channel for each profile. For additional information on configuring this profile, see [2.4 Ghz and 5 Ghz Radio RF Management on page 530](#).

- **Adaptive Radio Management (ARM):** defines the Adaptive Radio Management (ARM) settings for scanning, acceptable coverage levels, transmission power and noise thresholds. In most network environments, ARM does not need any adjustments from its factory-configured settings. However, if you are using VoIP or have unusually high security requirements you may want to manually adjust the ARM thresholds. For complete details on Adaptive Radio Management, refer to [Configuring ARM Profiles on page 453](#).
- **AM Scanning:** Aruba 802.11n APs and non-11n APs in AM-mode support the TotalWatch scanning feature giving them the ability to scan all channels of the RF spectrum, including 2.4-and 5-GHz bands as well as the

4.9-GHz public safety band. The AM Scanning profile enables this feature, and defines the dwell types for different channel types.

- **High-throughput radio:** manages high-throughput (802.11n) radio settings for 802.11n-capable APs. A high-throughput profile determines 40 Mhz tolerance settings, and controls whether or not the APs using this profile will advertise intolerance of 40 MHz operation. (This option is disabled by default, allowing 40 MHz operation.) For additional information on configuring this profile, see [High-Throughput APs on page 536](#).
- **RF Event Thresholds:** defines error event conditions, based on a customizable percentage of low-speed frames, non-unicast frames, or fragmented, retry or error frames. For additional information on configuring this profile, see [RF Event Configuration on page 534](#).
- **RF Optimization:** enables or disables load balancing based on a user-defined number of clients or degree of AP utilization on an AP. Use this profile to detect coverage holes, radio interference and STA association failures and configure Received signal strength indication (RSSI) metrics.

## Before you Deploy an AP

Before you install APs in a network environment, you must ensure that the APs are able to locate and connect to the managed device. Specifically, you must configure firewall settings to allow APs to obtain software images and configuration settings from the controller, verify APs are able to locate the Mobility Master, and verify each AP is assigned a valid IP address when connected to the network. If you want to provision APs with more than one interface, you can also configure the USB settings and interface priority levels using an AP provisioning profile.



---

Mobility Master cannot be used as an AP master since APs are not allowed to terminate on a Mobility Master. If the AP manager on Mobility Master receives an AP HELLO message, the message is dropped.

---

The following steps describe the basic pre-deployment tasks. Click any of the links for more information on these procedures.

1. [Configure Firewall Settings](#)
2. [Enable Controller Discovery](#)
3. [Enable DHCP](#)
4. [\(Optional\) Define the AP Provisioning Profile](#)
5. [Define a virtual AP profile, and assign that profile to an AP group](#)

### Mesh AP Preconfiguration

Mesh APs require the following additional steps to define the mesh networking environment.

- [Define and configure the mesh cluster profile.](#)
- [Define and configure the mesh radio profile](#)

### Remote AP Preconfiguration

Remote APs require the following additional step to identify valid APs in the remote AP whitelist.

- [Create a Remote AP whitelist](#)

## Enable Controller Discovery

An AP can discover the IP address of the controller from a DNS server, from a DHCP server, or using the Aruba Discovery Protocol (ADP).



At boot time, the AP builds a list of managed device IP addresses and then tries these addresses in order until it successfully reaches a managed device. This list of IP addresses provides an enhanced redundancy scheme for managed device that are located in multiple data centers separated across Layer-3 networks. The AP constructs its list of managed device addresses as follows:

- If the provisioning parameter is set to a DNS name, that name is resolved and all resulting addresses are put on the list. If is set to an IP address, that address is put on the list.
- If the provisioning parameter is not set and a managed device address was received in DHCP Option 43, that address is put on the list.
- If the provisioning parameter is not set and no address was received via DHCP option 43, ADP is used to discover a managed device address and that address is put on the list.
- Managed device addresses derived from the **server-name** and **server-ip** provisioning parameters and the default managed device name **aruba-master** are added to the list. Note that if a DNS name resolves to multiple addresses, all addresses are added to the list.

## Controller Discovery using DNS

When using DNS, AP learns multiple IP addresses to associate with a managed device. If the primary node is unavailable or does not respond, the AP continues through the list of learned IP addresses until it establishes a connection with an available managed device. This takes approximately 3.5 minutes per managed device.



---

It is recommended you use a DNS server to provide APs with the IP address of the managed device because it involves minimal changes to the network and provides the greatest flexibility in the placement of APs.

---

APs are factory-configured to use the host name **aruba-master** for the managed device that terminates the APs. For the DNS server to resolve this host name to the IP address of the managed device, you must configure an entry on the DNS server for the name **aruba-master**.

## Controller Discovery using ADP

ADP is enabled by default on all Aruba APs and managed devices. With ADP, APs send out periodic multicast and broadcast queries to locate the Mobility Master. ADP requires that all APs and managed devices are connected to the same Layer-2 network. If the devices are on different networks, you must use a Layer-3 compatible discovery mechanism, such as DNS, DHCP, or IGMP forwarding.

To use ADP discovery:

1. Issue the command **show adp config** to verify that ADP and IGMP join options are enabled on the managed device, If ADP is not enabled, you can reenale ADP using the command **adp discovery enable** and **adp igmp-join enable**.
2. If the APs are not in the same broadcast domain as the Mobility Master, you enable multicast on the network (ADP multicast queries are sent to the IP multicast group address 239.0.82.11) for the Mobility Master to respond to the APs' queries. You also must make sure that all routers are configured to listen for Internet Group Management Protocol (IGMP) join requests from the controller and can route these multicast packets.

## Controller discovery using a DHCP Server

You can configure a DHCP server to provide the Mobility Master's IP address. You must configure the DHCP server to send the managed device's IP address using the DHCP vendor-specific attribute option 43. The APs identify themselves with a vendor class identifier set to **ArubaAP** in their DHCP requests. When the DHCP server responds to a request, it will send the managed device's IP address as the value of option 43.

When using DHCP option 43, the AP accepts only one IP address. If the IP address of the managed device provided by DHCP is not available, the AP can use the other IP addresses provisioned or learned by DNS

to establish a connection. For more information on how to configure vendor-specific information on a DHCP server, see [DHCP with Vendor-Specific Options on page 1059](#) or refer to the documentation included with your server.

## Enable DHCP to Provide APs with IP Addresses

Each AP requires a unique IP address on a subnetwork that has connectivity to a managed device. It is recommended you use the Dynamic Host Configuration Protocol (DHCP) to provide IP addresses for APs; the DHCP server can be an existing network server or a managed device configured as a DHCP server.



---

If you do not enable DHCP, each AP must be manually configured with an IP address through the AP provisioning profile.

---

You can use an existing DHCP server in the same subnetwork as the AP to provide the AP with its IP information. You can also configure a device in the same subnetwork to act as a relay agent for a DHCP server on a different subnetwork. (Refer to the vendor documentation for the DHCP Server or relay agent for information.)

The Mobility Master can configure the managed device as a DHCP server to assign an IP address to the AP. The managed device must be the only DHCP server for this subnetwork.

### In the WebUI

1. In the **Managed Network** node hierarchy, navigate to the **Configuration > Services** window.
2. Open the **DHCP Server tab**
3. Select **Enable** from either **IPv4** or **IPv6 DHCP server** drop-down list.
4. In the **Pool Configuration** table, click **Add**.
5. Enter information about the subnetwork for which IP addresses are to be assigned.
6. Click **Submit**.

**Table 101:** *DHCP Configuration Parameters*

Parameter	Description
IP Version	Select the IP version used by the DHCP pool configuration
Pool name	Enter the name of the DHCP pool.
Default routers	Enter an IP address to assign the DHCP default router for the managed device
DNS Servers	Enter an IP address to assign the DHCP DNS server for the managed device
Import from DHCP/PPPoE	Enables/disables importing of DNS server configurations.
WINS	Enter IP address to assign WINS servers. When entering multiple servers, each server must be separated by a space.
Import from DHCP/PPPoE	Enables/disables importing WINS server configurations.

Parameter	Description
Lease days	Length of time a device may lease the DHCP in days. Entering <b>0</b> indicates no time limit.
Lease hours	Length of time a device may lease the DHCP in hours.
Lease minutes	Length of time a device may lease the DHCP in minutes.
Lease seconds	Length of time a device may lease the DHCP in seconds.
Network IP mask	Enter an IP address to assign the netmask for the DHCP pool

## Excluding IP Addresses

If there are addresses that should not be assigned in the subnetwork:

1. Click **Add** in the **Excluded Address Range** table that corresponds with the IP version used.
2. Enter the address range in the **Add Excluded Address** section.
3. Click **Apply**.

## In the CLI

The following commands can be used to configure the DHCP services.

```
(host) [node] (config) # ap system-profile <profile>
    rap-dhcp-default-router <ip-addr>
    rap-dhcp-dns-server <ip-addr>
    rap-dhcp-lease
    rap-dhcp-pool-end
    rap-dhcp-pool-start
    rap-dhcp-pool-netmask
    rap-dhcp-server-id
    rap-dhcp-server-vlan
(host) [node] (config) # ip dhcp
    adaptive
    default-pool
    excluded-address
    load-balance
    ping-check
    pool
(host) [node] (config) # service
    dhcp
    dhcpv6
```

## AP Provisioning

AP provisioning settings allow you to define a set of additional provisioning information for an AP, such as USB modem settings, PPPoE values, or configuration settings to provision an AP as a remote AP.

Make sure that any provisioning changes you make are complete and accurate before save those settings. If an AP is misconfigured with erroneous parameters, that AP may be lost.

1. Navigate to the **Configuration > Access Points** window.
2. Select the AP to which you want to add new provisioning settings, then click **Provision**. The AP provisioning settings are divided into two groups. By default, the ArubaOS WebUI displays configuration settings described in [Table 102](#).

**Table 102: AP Provisioning Profile parameters**

Parameter	Description
Name	Name assigned to an AP  <b>NOTE:</b> An AP requires a reboot before a new AP name takes effect. Therefore, wait until there is little or no client traffic passing through the AP before renaming it.
AP Group	AP group to which the AP is assigned.
Remote-AP	Select this check box to provision the APs as a remote APs. If you are provisioning remote APs, you must also add the remote APs to the RAP whitelist. For details, see <a href="#">Remote Access Points on page 639</a> .
Controller Discovery	Select <b>DHCP</b> if you have configured a DHCP server to provide the AP with the master controller's IP address, or select <b>Static</b> to manually define the AP's managed device IP.  <ul style="list-style-type: none"> <li>If you select the <b>Static</b> option, you are prompted to enter the managed device's DNS name or IP address.</li> <li>If you select the <b>DHCP</b> option, You must configure the DHCP server to send the controller's IP address using the DHCP vendor-specific attribute option 43.</li> </ul> <p>When using DHCP discovery, the APs identify themselves with a vendor class identifier set to ArubaAP in their DHCP requests. When the DHCP server responds to a request, it will send the controller's IP address as the value of option 43.</p> <p>When using DHCP option 43, the AP accepts only one IP address. If the IP address of the controller provided by DHCP is not available, the AP can use the other IP addresses provisioned or learned by DNS to establish a connection. For more information on how to configure vendor-specific information on a DHCP server, see <a href="#">Enable DHCP to Provide APs with IP Addresses on page 506</a> or refer to the documentation included with your server.</p>
IP	Select <b>DHCP</b> if you have configured a DHCP server to provide the AP with the the AP IP address, or select <b>Static</b> to manually define the AP's IP address.  If you select the Static option, you are prompted to enter the following information for the selected AP:  <ul style="list-style-type: none"> <li>IPv4 address, netmask and DNS server</li> <li>IPv6 address and DNS server</li> <li>IP address of the internet gateway used by the AP.</li> </ul>
TFTP Server	IP address of the TFTP server from which the AP can download its boot image.
Coverage Area	This setting defines the type of installation ( <b>indoor</b> or <b>outdoor</b> ). The <b>default</b> option indicates that the installation mode is determined by the AP model type.

Parameter	Description
Single Chain Mode	If this option is enabled for an 802.11n-capable radio, the radio will operate in single-chain mode, and will transmit and receive data using only legacy rates and single-stream HT rates up to MCS 7. This parameter is disabled by default.
PEAP username	Username of AP so that AP can authenticate to 802.1X using PEAP.
PEAP password	Password of AP so that AP can authenticate to 802.1X using PEAP.

## Configuring Installed APs

APs and AMs are designed to require only minimal setup to make them operational in an user-centric network. Once APs have established communication with the managed device, you can apply advanced configuration to individual APs or groups of APs in the network using the WebUI on the managed device.

You can either connect the AP directly to a port on the managed device, or connect the AP to another switch or router that has layer-2 or layer-3 connectivity to the managed device. If the Ethernet port on the managed device is an 802.3af Power over Ethernet (PoE) port, the AP automatically uses it to power up. If a PoE port is not available, you must get an AC adapter for the AP. For more information, see the Installation Guide for the specific AP.

If you are configuring a new AP that has never been provisioned before, you must first connect the AP to the managed device according the instructions included with that AP. If you are reprovisioning or reconfiguring existing active APs, this step is not necessary, as the APs are already communicating with the managed device.

This section describes the procedure to configure a installed AP with the basic settings it requires to become operational on the network. You can configure an AP using the AP wizard, the provisioning profile in the WebUI, or the managed device command-line interface. using The individual configuration steps vary, depending upon whether the AP is deployed as a campus AP, remote AP (RAP) or a mesh AP.

### Configuring an AP using the web UI

The easiest way to provision any AP is to use the AP Wizard in the managed device WebUI. This wizard will walk you through the specific steps required to provision a campus, remote or Mesh AP. The Wizard includes a help tab that further describes each of the configuration tasks for that deployment type.

To access the AP wizard to provision a AP:

1. Select the managed device to which the AP will be provisioned.
2. Navigate to the **Configuration > Access Points** page.
3. Select the new AP from the **Campus APs** list, then click **Provision**.
4. In the **General** section, click the **AP Group** drop-down list and select the AP group to which this AP should be assigned. The AP group must have at least one virtual AP.
5. (Optional) Some AP models support an external antenna in addition to their internal antenna. If the AP you are provisioning supports an external antenna, the Provisioning window displays an additional **Antenna Parameters** section.
6. If your AP will use Point-to-Point Protocol over Ethernet (PPPoE) to authenticate itself to a service provider, open the **Uplink** tab to enter the parameters in the **PPPoE** section:
  - PPPoE User Name: Set the PPPoE User Name for this remote AP.
  - PPPoE Password: Enter and then confirm the PPPoE password for this remote AP.
  - PPPoE Service Name: Either an ISP name or a class of service configured on the PPPoE server.

7. (Optional) To allow the remote AP to use PEAP to authenticate to 802.1X networks, select **Show Advanced Options** under the **General** tab, then enter a user name and password in the 802.1X Parameter using PEAP section.
8. (Optional) Define the uplink VLAN. If you configure an uplink VLAN on an AP connected to a port in trunk mode, the AP sends and receives frames tagged with this VLAN on its Ethernet uplink. To define the uplink VLAN, entering a VLAN ID from 1-4095 (inclusive) in the **IP Settings** section of the **Provisioning** window,
9. In the **IP Settings** section, define how the AP should obtain its IP address. If you have configured an DHCP server to allow APs to get addresses using DHCP, select **Obtain IP address using DHCP**. For more information on configuring a DHCP server, see [Enable DHCP to Provide APs with IP Addresses on page 506](#). Otherwise, select **Use the Following IP address** and enter the appropriate values in the following fields:
  - **IP address:** IP address for the AP, in dotted-decimal format
  - **Subnet mask:** Subnet mask for the IP, in dotted-decimal format.
  - **Gateway IP address:** The IP address the AP uses to reach other networks.
  - **DNS IP address:** The IP address of the Domain Name Server.
  - **Domain name:** (optional) The default domain name.
10. (Optional) Access points can be configured in single-chain mode, allowing the radios of those APs to transmit and receive data using only legacy rates and single-stream HT and VHT rates on a single radio chain and single antenna or antenna interface. On APs with external antennas, this feature uses the external antenna interface labeled **A0** or **ANT0** (radio chain 0); the other (one or two) antenna interfaces are left unused. If you are provisioning an 802.11n-capable AP, select the **Enable for Radio-0** or **Enable for Radio-1** check boxes in the **Single-Chain Mode** section to enable single-chain mode for the selected radio. AP radios in single-chain mode will transmit and receive data using only legacy rates and single-stream HT rates up to MCS 7. This feature is disabled by default.
11. (Optional) If you are provisioning a campus AP model that support USB modems, you must complete the fields in the **USB Settings** section. USB settings will not appear in the **Provisioning** tab unless you are provisioning an AP that support these features. Check the **USB Parameters** check box and configure the additional cellular USB settings described in [Table 103](#).
12. (Optional) Define the AP name or SNMP location. The **AP list** section displays current information for an AP, and allows you to define additional parameters for your AP, such as AP Name, SNMP System Location.
13. Click **Submit** (Reprovisioning the AP causes it to automatically reboot).

**Table 103:** *USB Settings*

Parameter	Description
Device	Select the USB modem model from the drop-down list. If the model is not listed, select <b>Other (Any)</b> .
TTY Device Data Path	The TTY device path for the USB modem. This parameter only needs to be specified if the default path is incorrect.
TTY Device Control Path	The TTY device control path for the USB modem. This parameter only needs to be specified if the default path is incorrect.
Initialization String	The initialization string for the USB modem. This string configures the Access Point Name (APN) setting of the USB modem. For the USB modem to understand this string, the value entered should adhere to the following formats: <ul style="list-style-type: none"> <li>● Prefix double-quotes with a backslash character. See example below:</li> </ul>

Parameter	Description
	<p><b>"AT+CGDCONT=1,\"IP\",\"vendor\""</b></p> <ul style="list-style-type: none"> <li>Use single-quote instead of double-quotes. AP translates single-quote into double-quotes. See example below:</li> </ul> <p><b>"AT+CGDCONT=1,'IP','vendor'"</b></p> <ul style="list-style-type: none"> <li>Do not use double-quotes as a string begin-end pair. This is supported by AP. See example below:</li> </ul> <p><b>AT+CGDCONT=1,'IP','vendor'</b></p> <p>This parameter only needs to be specified if the default string is incorrect.</p>
Device Identifier	The USB device identifier, if the device is not already supported.
Device Type	<p>Specify the USB driver type from the following list:</p> <ul style="list-style-type: none"> <li><b>acm</b>: Use ACM driver</li> <li><b>airprime</b>: Use Airprime driver</li> <li><b>beceem-wimax</b>: Use Beceem driver for 4G-WiMAX</li> <li><b>ether</b>: Use CDC Ether driver for direct IP 4G device</li> <li><b>hso</b>: Use HSO driver for newer Option</li> <li><b>none</b>: Disable 3G or 2G network on USB</li> <li><b>option</b>: Use Option driver</li> <li><b>pantech-3g</b>: Same as "pantech-uml290" - to support upgrade</li> <li><b>pantech-uml290</b>: Use Pantech USB driver for UML290 device</li> <li><b>ptumlbnet</b>: Use Pantech USB driver for 4G device</li> <li><b>rndis</b>: Use a RNDIS driver for a 4G device</li> <li><b>sierra-evdo</b>: Use EVDO Sierra Wireless driver</li> <li><b>sierra-gsm</b>: Use GSM Sierra Wireless driver</li> <li><b>sierrausbnet</b>: Use SIERRA Direct IP driver for 4G device</li> <li><b>storage</b>: Use USB flash as storage device for storing RAP certificates</li> </ul>
Dial String	The dial string for the USB modem. This parameter only needs to be specified if the default string is incorrect.
PPP Username	Enter the PPP username provided by the cellular service provider.
PPP Password	Enter the optional PPP password provided by the cellular service provider.
Confirm PPP Password	Re-enter the optional PPP password provided by the cellular service provider.
Modeswitch	USB cellular devices on remote APs typically register as modems, but may occasionally register as a mass-storage device. If a remote AP cannot recognize its USB cellular modem, use setting to specify the parameters for the hardware model of the USB cellular data-card.

Parameter	Description
	<p><b>NOTE:</b> You must enclose the entire modeswitch parameter string in quotation marks. Example follows:</p> <p><b>"-v &lt;default_vendor&gt; -p &lt;default_product&gt; -V &lt;target_vendor&gt; -P &lt;target_product&gt; -M &lt;message_content&gt;"</b></p>
Cellular NW Preference	<p>The cellular modem network preference setting allows you to select how the modem should operate.</p> <ul style="list-style-type: none"> <li>• <b>auto</b> (default): In this mode, the modem firmware will control the cellular network service selection; so the cellular network service failover and fallback is not interrupted by the remote AP (RAP).</li> <li>• <b>3g_only</b>: Locks the modem to operate only in 3G.</li> <li>• <b>4g_only</b>: Locks the modem to operate only in 4G.</li> <li>• <b>advanced</b>: The RAP controls the cellular network service selection based on the Received Signal Strength Indication (RSSI) threshold-based approach. Initially the modem is set to the default auto mode. This allows the modem firmware to select the available network. The RAP determines the RSSI value for the available network type (for example 4G), checks whether the RSSI is within required range, and if so, connects to that network. If the RSSI for the modem's selected network is not within the required range, the RAP will then check the RSSI limit of an alternate network (for example, 3G), and reconnect to that alternate network. The RAP will repeat the above steps each time it tries to connect using a 4G multi-mode modem in this mode.</li> </ul>
Link Priority Ethernet	Set the priority of the wired uplink. Each uplink type has an associated priority; wired ports having the highest priority by default.
Link Priority Cellular	<p>Set the priority of the cellular uplink. By default, the cellular uplink is a lower priority than the wired uplink; making the wired link the primary link and the cellular link the secondary or backup link.</p> <p>Configuring the cellular link with a higher priority than your wired link priority will set your cellular link as the primary managed device link.</p>
USB storage for CSR/Key	Check this box if you want the USB to store CSR and private key files.

## Configuring a Remote AP

A remote AP (RAP) is recommended when the network between the AP and managed device is an untrusted/non-routable network, such as the Internet. Furthermore, a RAP supports an internal DHCP server, while a campus AP does not.

### Remote Authentication

The two most common ways to provision an AP for remote authentication are certificate-based AP provisioning and provisioning using a pre-shared key. Although both options allow for a simple secure setup of your remote network, you should make sure that the procedure you select is supported by your managed device, the AP model type and the end user's client software. If you must provision your APs using a pre-shared key, you need to know which managed device models you have that do not support certificate-based provisioning.

- **Certificate based authentication** allows a managed device to authenticate a AP using its certificates instead of a PSK. You can manually provision an individual AP with a full set of provisioning parameters, or



simultaneously provision an entire group of APs by defining a provisioning profile which contains a smaller set of provisioning parameters that can be applied the entire AP group. When you manually provision an individual AP to use certificated-based authentication, you must connect that AP to the managed device before you can define its provisioning settings.

- Use **Pre-Shared Key (PSK) authentication** to provision an individual remote AP or a group of remote APs using an Internet Key Exchange Pre-Shared Key (IKE PSK).

## RAP Configuration

The steps to configure a remote AP using the WebUI are similar to the steps described in [Configuring an AP using the web UI](#) , although some additional steps are required.

1. Select the managed device to which the AP will be provisioned.
2. Navigate to the **Configuration > Access Points** page.
3. Open the **Remote APs** tab
4. Select the new RAP from the **Remote AP** list, then click **Provision**.
5. In the **General** section, click the **AP Group** drop-down list and select the AP group to which this AP should be assigned. The AP group must have at least one virtual AP.
6. (Optional) Some AP models support an external antenna in addition to their internal antenna. If the AP you are provisioning supports an external antenna, the Provisioning window displays an additional **Antenna Parameters** section.
7. If your AP will use Point-to-Point Protocol over Ethernet (PPPoE) to authenticate itself to a service provider, open the **Uplink** tab to enter the parameters in the **PPPoE** section:
  - PPPoE User Name: Set the PPPoE User Name for this remote AP.
  - PPPoE Password: Enter and then confirm the PPPoE password for this remote AP.
  - PPPoE Service Name: Either an ISP name or a class of service configured on the PPPoE server.
8. (Optional) To allow the remote AP to use PEAP to authenticate to 802.1X networks, select **Show Advanced Options** under the **General** tab, then enter a user name and password in the 802.1X Parameter using PEAP section.
9. If you are provisioning a remote AP model that support USB modems, you must complete the fields in the **USB Settings** section. USB settings will not appear in the **Provisioning** tab unless you are provisioning an AP that support these features. Check the **USB Parameters** check box and configure the additional cellular USB settings described in [Table 103](#).

## Verifying the Configuration

After the AP has been configured, navigate to **Dashboard** page and verify that the AP has an **up** status. The AP on your network *does not* appear in this table, it may have been classified as an inactive AP for any of the following reasons:

- The AP is configured with a missing or incorrect VLAN. (For example, the AP is configured to use a tunneled SSID of VLAN 2 but the controller doesn't have a VLAN 2.)
- The AP has an unknown AP group.
- The AP has a duplicate AP name.
- An AP with an external antenna is not provisioned with external antenna gain settings.
- Both radios on the AP are disabled.
- No virtual APs are defined on the AP.
- The AP has profile errors. For details, access the command-line interface and issue the command "show profile errors".

- The GRE tunnel between the AP and the managed device was blocked by a firewall after the AP became active.
- The AP is temporarily down while it is upgrading its software. The AP will become active again after upgrading.

## Configuring AP Image Preload

The AP image preload feature minimizes the downtime required for a managed device upgrade by allowing the APs associated to that managed device to download the new images before the managed device actually starts running the new version.

This feature allows you to select the maximum number of APs that are allowed to preload the new software image at any one time, thereby reducing the possibility that the managed device may get overloaded or that network traffic may be impacted by all APs on the managed device attempting to download a new image at once.

APs can continue normal operation while they are downloading their new software version. When the download completes, the AP sends a message to the managed device, informing it that the AP has either successfully downloaded the new software version, or that the preload has failed for some reason. If the download fails, the AP will retry the download after a brief waiting period.

You can allow every AP on a managed device to preload a new software version, or also create a custom list of AP groups or individual APs that can use this feature. If a new AP associates to the managed device while the AP image download feature is active, the managed device will check that AP's name and group to see if it appears in the preload list. If an AP is on the list, (and does not already have the specified image in its Flash memory) that AP will start preloading its image.




---

Once a software version has been downloaded, another version cannot be downloaded until the AP reboots.

---

## Enable and Configure AP Image Preload



To configure the AP image preload feature using the command-line interface, enter the following commands in **enable** mode.

```
ap image-preload
  activate all-aps|specific-aps
  add {ap-group <ap-group> | ap-name <ap-name>}
  cancel
  clear-all
  delete {ap-group <ap-group> | ap-name <ap-name>}
  [partition <part-num>]
  [max-downloads <max-downloads>]
```

The parameters for this command are described in [Table 104](#).

**Table 104: AP Image Preload Configuration Parameters**

Parameter	Description
activate	Issue the <b>ap image-preload activate</b> command to activate this feature, allowing APs in the preload list to start downloading their new image from the managed device.
all-aps	All APs will be allowed to pre download the image.
specific-aps	Only APs in the preload list will be allowed to preload the image.
add	Add individual APs or AP groups to the list of APs allowed to preload the image.
ap-group <group>	Add a group of APs to the preload list.
ap-name <name>	Add an individual AP to the preload list.
cancel	Cancel the AP preload and clear the preload list. Any APs downloading a new image at the time this command is issued will continue to download the file.
clear-all	Clear all APs from the preload list.
delete	Delete an individual AP or AP group from the preload list. <b>NOTE:</b> This command may be issued before or after preloading is activated. If it is executed after preloading has already been activated, any APs downloading a new image at the time this command is issued will continue to download the file. APs that are still waiting to preload will be removed from the preload list.
ap-group <group>	Remove the specified group of APs from the preload list
ap-name <name>	Remove an individual AP from the preload list
partition <partition-num>	Specify the partition from which the APs should download their images. By default, the APs will preload images from the managed device's default boot partition.
max-downloads <max-downloads>	Specify the maximum number of APs that can simultaneously download their image from the managed device. The default value is ten APs.

## View AP Preload Status

You can monitor the current preload status of APs using the image preload feature using the **show ap image-preload status summary** command in the command-line interface. The output of this command contains the following information:

**Table 105:** AP Image Preload Status Settings

Column	Description
AP Image Preload State/Count	<p>These two columns list the different possible preload states for APs eligible to preload a new software image, and the total number of APs in each state.</p> <ul style="list-style-type: none"> <li>● <b>Preloaded:</b> Number of APs that have finished preloaded a new software image.</li> <li>● <b>Preloading:</b> Number of APs that are currently downloading the new image.</li> <li>● <b>Waiting:</b> Number of APs that are waiting to start preloading the new image from the managed device.</li> </ul>
Count	This column lists the number of eligible APs currently in each preload state.
AP Name	Name of an AP eligible to preload a new software image.
AP Group	AP group of an AP eligible to preload a new software image.
AP IP	IP address of the AP.
AP Type	AP model type.
Preload State	<p>Current preload state for the AP</p> <ul style="list-style-type: none"> <li>● <b>Preloaded:</b> The AP is finished preloading a new software image.</li> <li>● <b>Preloading:</b> The AP is currently downloading the new image.</li> <li>● <b>Waiting:</b> The AP is waiting to start preloading the new image from the managed device.</li> </ul>
Start Time	Time the AP starting preloading an image.
End Time	Time the AP completed the image preload.
Failure Count	Number of times that the AP failed to preload the new image.
Failure Reason	In the event of an image preload failure, this column will display the reason that the image download failed.

## Optional AP Configuration Settings

Once the AP has been installed and provisioned, you can use the WebUI or CLI to configure the optional AP settings described in the following sections:

- [Spanning Tree on page 517](#)
- [PortFast on page 517](#)
- [Enabling PortFast On a Trunk Port on page 517](#)
- [AP Console Access Using a Backup ESSID on page 517](#)
- [Defining an RTLS Server on page 518](#)
- [AP Redundancy on page 518](#)
- [AP Maintenance Mode on page 518](#)

- [Energy Efficient Ethernet on page 518](#)
- [AP LEDs on page 519](#)
- [Suppressing Client Probe Requests on page 520](#)
- [BLE Operation Mode on page 521](#)
- [Configuring the AP System Profile on page 521](#)
- [Configuring the AP Wired Port Profile on page 529](#)

## Spanning Tree

The Spanning Tree Protocol (STP) can prevent loops in bridged Ethernet local area networks. Spanning tree settings can be configured via the WebUI and command-line interface.

To enable this feature, enable both the **Spanning Tree** parameter in the AP system profile and the **Spanning Tree** parameter in the AP wired port profile. For details, see [Configuring the AP System Profile on page 521](#).

## PortFast

The PortFast feature is introduced to avoid network connectivity issues. These issues are caused by delays in STP enabled ports moving from blocking-state to forwarding-state after transitioning from the listening and learning states. STP enabled ports that are connected to devices such as a single switch, workstation, or a server can access the network only after passing all these STP states. Some applications need to connect to the network immediately, else they will timeout.

Spanning Tree should be enabled on the access point before enabling PortFast. If PortFast is configured, it is enabled only on access mode ports and if PortFast-Trunk is configured, it is enabled on trunk-mode ports only. Only one of them can be set based on the port's switchport mode.

### Enabling PortFast on an Access Port

Before enabling PortFast ensure that the switchport mode is set to **access**:

```
(host) [mynode] #show ap wired-port-profile <profile>
```

Execute the following commands in config mode to enable PortFast on an access port:

```
(host) [mynode] (config) #ap wired-port-profile "default"
(host) [mynode] (AP wired port profile "default") #portfast
```

### Enabling PortFast On a Trunk Port

Before enabling PortFast ensure that the switchport mode is set to **trunk**:

```
(host) [mynode] #show ap wired-port-profile <profile>
```

Execute the following commands in config mode to enable PortFast on a trunk port:

```
(host) [mynode] (config) #ap wired-port-profile "default"
(host) [mynode] (AP wired port profile "default") #portfast-trunk
```

## AP Console Access Using a Backup ESSID

This failover system allows users to access an AP console after the AP has disconnected from the managed device. By advertising backup ESSID in either static or dynamic mode, the user is still able to access and debug the AP remotely through a virtual AP. Settings for this feature are configured using the **Password for Backup**, **RF Band for Backup**, and **Operation for backup** parameters in the AP system profile. For details, see [Configuring the AP System Profile on page 521](#).

## Defining an RTLS Server

The RTLS server configuration enables the AP to send RFID tag information to an RTLS server. Currently, when configuring the RTLS server under **ap system-profile**, you can set the **station-message-frequency** parameter in the 1-3600 seconds range. Setting the frequency to 1 means a report is sent for every station every second. A value of 5 means that a report for a ny particular station would be sent at 5 second intervals.

- Sending more frequent reports to the server can improve the accuracy of the location calculation.
- Configuring an AP to send reports more frequently adds additional load in terms of CPU usage.

Settings for this feature are configured using the **RTLS Server configuration** parameters in the **Advanced** section the AP system profile. For details, see [Configuring the AP System Profile on page 521](#).

## AP Redundancy

In conjunction with the managed device redundancy features described in [Increasing Network Uptime Through Redundancy and VRRP on page 590](#) the information in this section describes redundancy for APs. Remote APs also offer redundancy solutions via a backup configuration, backup managed device list, and remote AP failback. For more information relevant to remote APs, see [Remote Access Points on page 639](#).

The AP failback feature allows an AP associated with the backup managed device (backup LMS) to fail back to the primary managed device (primary LMS) if it becomes available.

If configured, the AP monitors the primary managed device by sending probes every 600 seconds by default. If the AP successfully contacts the primary managed device for the entire hold-down period, it will fail back to the primary managed device. If the AP is unsuccessful, the AP maintains its connection to the backup managed device, restarts the LMS hold-down timer, and continues monitoring the primary managed device.

Settings for this feature are configured using the LMS IP parameters in the **LMS settings** section of the AP system profile. For details, see [Configuring the AP System Profile on page 521](#).

## AP Maintenance Mode

You can configure APs to suppress traps and syslog messages related to those APs. Known as AP maintenance mode, this setting in the AP system profile is particularly useful when deploying, maintaining, or upgrading the network. If enabled, APs stop flooding unnecessary traps and syslog messages to network management systems or network operations centers during a deployment or scheduled maintenance. The managed device still generates debug syslog messages if debug logging is enabled. After completing the network maintenance, disable AP maintenance mode to ensure all traps and syslog messages are sent. AP maintenance mode is disabled by default.

The AP maintenance mode is configured by enabling **Maintenance Mode** parameter in the **Advanced** section of the AP system profile. For details, see [Configuring the AP System Profile on page 521](#).

To view the maintenance mode status of APs, use the following commands in the Mobility Master command-line interface:

```
show ap config {ap-group <name>|ap-name <name>|ssid <name>}
show ap debug system-status {ap-name <name>|bssid <name>| ip-addr <ipaddr>}
```

## Energy Efficient Ethernet

Most newer models of Aruba APs support the 803.az Energy Efficient Ethernet (EEE) standard, which allows the APs to consume less power during periods of low data activity. This setting can be enabled for provisioned APs or AP groups through the Ethernet Link profile. If this feature is enabled for an AP group, any APs in the group that do not support 803.az will ignore this setting.

Energy Efficient Ethernet is configured using the AP Ethernet Link profile.

## In the WebUI

1. Navigate to the **Configuration > System > Profiles** page.
2. Select **AP > AP Ethernet Link**, and select the Ethernet link profile you want to modify. The parameters for the profile are described in [Table 106](#).

**Table 106:** Ethernet Interface Link Profile Parameters

Parameter	Description
Speed	The speed of the Ethernet interface, either 10 Mbps, 100 Mbps, 1000 Mbps (1 Gbps), or auto-negotiated.
Duplex	The duplex mode of the Ethernet interface, either full, half, or auto-negotiated.
802.3az (EEE)	Select this check box to enable support for 802.1az Energy Efficient Ethernet. (for 130 Series only).
Power Over Ethernet	Enable Power over Ethernet (PoE) for APs that support PoE.

By default, AP wired port profiles reference the Default Ethernet interface link profile. If you created a new Ethernet interface link profile to support 803.az, use the procedure below to associate a AP wired port profile or Ethernet interface port configuration with the new Ethernet Interface link profile.

To associate a new Ethernet interface link profile with a wired port profile:

1. In the **Managed Network** node hierarchy, navigate to the **Configuration > System > Profiles** page.
2. Navigate to **AP > AP Wired Port Profile** on the **Profile** pane, then select the AP Wired Port profile you want to modify.
3. Click the Ethernet interface link profile currently associated with the AP wired port profile you want to modify. This profile appears below the AP Wired Port Profile in the **All Profiles** list.
4. Click the **Ethernet interface link profile** drop-down list at the top of the **Profile Details** window, and select a new Ethernet interface link profile.
5. Click **Apply** to save your changes.

## In the CLI

To enable support for 803.az EEE, access the command-line interface in config mode and issue the following command:

```
(host) [node] (config) #ap enet-link-profile <profile>
dot3az
```

Associate a new Ethernet Interface link profile with an AP wired port profile using the following command:

```
(host) [node] (config) #ap wired-port-profile <profile>
enet-link-profile <profile>
```

## AP LEDs

AP LEDs on 802.11n and 802.11ac APs can be configured in two modes: **normal** and **off**. In normal mode, the AP LEDs will light as expected. When the mode is set to off, all of the LEDs on the affected APs are disabled. The AP LED mode is configured by enabling the **LED Operating Mode** parameter in the **General** section of the AP system profile. For details, see [Configuring the AP System Profile on page 521](#).

## Suppressing Client Probe Requests

The anyspot client probe suppression feature decreases network traffic by suppressing probe requests from clients attempting to locate and connect to other known networks. By reducing the frequency at which these messages are sent, this feature frees up network resources and improves network performance.

When an AP is configured to use this feature, the anyspot AP radio hides its configured ESSID in beacons, and compiles a list of other ESSIDs from detected neighboring APs. If the client sends a probe request without a specified ESSID, the anyspot AP will respond with a preconfigured ESSID.

When a client searches for a preferred network, that client sends the SSID of the preferred network in the probe request. The anyspot AP checks to see if there is a neighboring AP using that ESSID that can respond the client's request. If no matching network is found, the anyspot AP sends a response to the client using the SSID from the client request. If the client is authorized to connect to the anyspot AP, that client associates to AP. Once connected to the anyspot AP, the client recognizes the ESSID to which it is connected as one associated with its preferred network, and does not send out any further probe requests.



---

An AP radio can only use this feature when encryption is disabled. (That is, when the **operation mode** parameter in the AP radio's WLAN SSSID profile is set to **opensystem**.)

---

You can define a list of excluded ESSIDs to which the anyspot AP will not respond. If a client sends probe request with an ESSID on the excluded ESSID list, the anyspot AP will not respond to the request, even if there is no neighboring AP using that ESSID. Excluded ESSIDs can be identified by exact name or a matching string.

### In the WebUI

Use the following procedure to suppress client probe requests by enabling the anyspot feature.

1. In the **Managed Network** node hierarchy, navigate to the **Configuration > System > Profiles** page.
2. Navigate to **Wireless LAN > Anyspot** on the **Profile** pane, then select the Anyspot profile you want to modify.
3. Configure the anyspot parameters described in [Table 107](#).

**Table 107:** *Anyspot Client Probe Suppression Configuration Parameters*

Parameter	Description
Enable Anyspot	Select this check box to enable the anyspot feature. Note that you must associate the anyspot profile with a virtual AP profile for the settings to take effect.
Exclude ESSID(s) (exact match)	An anyspot-enabled radio will not respond to client probe requests using an ESSID in the <b>Exclude ESSID</b> lists. To add an ESSID to the list, enter the full name of the ESSID, then click <b>Add</b> . To remove an ESSID from the list, select it and click <b>Delete</b> . ESSIDs from neighboring APs will automatically appear in this list as long as the anyspot-enabled AP can detect that ESSID.
Exclude ESSID(s) (containing string)	An anyspot-enabled radio will not respond to client probe requests using an ESSID in the <b>Exclude ESSID</b> list. To exclude ESSIDs that partially match a text string, enter that string then click <b>Add</b> . To remove a matching string from the list, select it and click <b>Delete</b> .
Preset ESSID(s)	The anyspot-enabled AP will not send an ESSID in beacons, but if a client sends a probe requests without ESSIDs (that is, the probe request is not looking for a specific network) then the anyspot-enabled AP will respond to the probe request with an ESSID from this list.



If you create a new Anyspot profile, use the procedure below to associate the anyspot profile with a selected WLAN via the virtual AP profile.

To associate a new Ethernet interface link profile with a wired port profile:

1. In the **Managed Network** node hierarchy, navigate to the **Configuration > System > Profiles** page.
2. Select **AP > Virtual AP** on the **Profile** pane, then select the Virtual AP profile for the WLAN you want to modify.
3. Click the **Anyspot** profile currently associated with the Virtual AP profile. This profile appears below the Virtual AP Profile in the **All Profiles** list.
4. Click the **Anyspot profile** drop-down list and select the new **Anyspot** profile.

### In the CLI

Use the following commands to configure the anyspot profile, and associate an anyspot profile with a virtual AP.

```
(host)[node] (config) #wlan anyspot-profile <anyspot-profile>
(host)[node] (config) #wlan virtual-ap profile <profile>
    anyspot <profile>
```

## BLE Operation Mode

The **BLE Operation Mode** setting determines how the built-in Bluetooth Low Energy (BLE) chip in the AP functions. You can configure this setting using the Mobility Master WebUI or CLI.



---

BLE is disabled on the ArubaOS FIPS build. The **BLE Operation Mode** setting is currently supported in 320 Series access points only.

---

This feature supports the following modes:

- **Beaconing:** The AP's built-in BLE chip functions as an iBeacon combined with beacon management functionality.
- **Disabled:** The AP's built-in BLE chip is turned off. This is the default setting.
- **DynamicConsole:** The AP's built-in chip functions as a regular iBeacon combined with beacon management functionality. However, when the link to the managed device is lost, the built-in chip temporarily enables access to the AP console over BLE. This state of the BLE device may be rolled back to any of the other modes if the AP receives a different configuration setting for the **ble-op-mode** parameter from the new LMS.
- **PersistentConsole:** The AP's built-in chip provides access to the AP console over BLE using a mobile application. This functionality is the superset of the **Beaconing** mode.

Settings for this feature are configured using the **BLE Operation Mode** parameter in the **Advanced** section of the AP system profile. For details, see [Configuring the AP System Profile on page 521](#).

## Configuring the AP System Profile

The AP system profile configuration settings are divided into four groups, **General**, **LMS Settings**, **Remote AP** and **Advanced**. The **General**, **LMS Settings**, and **Remote AP** sections of this profile include configuration settings that often need to be adjusted to suit a specific network. The **Advanced** tab includes settings that do not need frequent adjustment or should be kept at their default values.

### In the WebUI:

To configure AP settings via the AP system profile:

1. In the **Managed Network** node hierarchy, navigate to **Configuration > System > Profiles** and expand the **AP** profiles menu.
2. Expand the AP system profile menu and select the name of an existing profile or click **Add** to create a new profile.
3. Configure the profile parameters described in [Table 108](#), then click **Save**.

**Table 108:** AP System Profile Configuration

Parameter	Description
<b>General AP System Profile Settings</b>	
RF Band	For APs that support both 802.11a and 802.11b/g RF bands, specify the RF band in which the AP should operate: <ul style="list-style-type: none"> <li>• g = 2.4 GHz</li> <li>• a = 5 GHz</li> </ul>
RF Band for AM Mode scanning	For Air Monitors that support both 802.11a and 802.11b/g RF bands, specify the RF band which the AM should scan: <ul style="list-style-type: none"> <li>• a = 5 GHz</li> <li>• all = both radio bands</li> <li>• g = 2.4 GHz</li> </ul>
Native VLAN ID	Native VLAN for bridge mode virtual APs (frames on the native VLAN are not tagged with 802.1q tags).
Session ACL	Session ACL configured with the ip access-list session command. <b>NOTE:</b> This parameter requires the PEFNG license.
Corporate DNS Domain	Name of domain that is resolved by corporate DNS servers. Use this parameter when configuring split-tunnel forwarding.
SNMP sysContact	SNMP system contact information.
LED operating mode	The operating mode for the LEDs on 802.11n-capable indoor AP. supported options are normal mode, and off, which disables all LEDs.
LED Override	Override the LED action for single-LED APs in normal LED operating mode. If enabled, this feature disables the LED auto-turn-off function.
Driver Log Level	Level of AP driver logs sent to the syslog server. Supported options are: <ul style="list-style-type: none"> <li>• <b>alerts:</b> Immediate action needed</li> <li>• <b>critical:</b> Critical Conditions</li> <li>• <b>debugging:</b> Debugging Messages</li> <li>• <b>emergencies:</b> System is unusable</li> <li>• <b>errors:</b> Error Conditions</li> </ul>

Parameter	Description
	<ul style="list-style-type: none"> <li>● <b>informational:</b> Informational Messages</li> <li>● <b>notifications:</b> Normal but significant conditions</li> <li>● <b>warnings:</b> Warning conditions</li> </ul>
SAP MTU	Maximum Transmission Unit, in bytes, on the wired link for the AP.
RAP MTU	Configures the maximum size of the GRE packets exchanged between a RAP and the managed device.
Secondary Master IP/FQDN	The secondary Mobility Master is configured to be used when a RAP is not able to reach the primary Mobility Master.
Spanning Tree	Enables the spanning-tree protocol.
AP Multicast Aggregation	Enable multicast aggregation at AP
AP ARP attack protection	Drop ARP packets coming from wired or wireless clients with AP gateway IP address. In other words, disallow ARP attack from untrusted ports.
AP multicast aggregation allowed VLANs	Enable a list of VLANs where AP multicast aggregation is allowed.
<b>LMS AP System Profile Settings</b>	
LMS IP	<p>This parameter specifies the IP address of the local management switch (LMS)—the managed device—which is responsible for terminating user traffic from the APs, and processing and forwarding the traffic to the wired network. This can be the IP address of the managed device or Mobility Master.</p> <p>When using redundant managed devices as the LMS, set this parameter to be the VRRP IP address to ensure that APs always have an active IP address with which to terminate sessions.</p> <p><b>NOTE:</b> If the LMS-IP is blank, the access point will remain on the managed device that it finds using methods like DNS or DHCP. If an IP address is configured for the LMS IP parameter, the AP will be immediately redirected to the managed device at that address.</p>
Backup LMS IP	This parameter specifies the IP address of a <i>backup</i> to the IP address specified with the lms-ip parameter.
LMS IPv6	<p>This parameter specifies the IPv6 address of the local management switch (LMS)—the managed device—which is responsible for terminating user traffic from the APs, and processing and forwarding the traffic to the wired network. This can be the IP address of the managed device or Mobility Master.</p> <p>When using redundant managed devices as the LMS, set this parameter to be the VRRP IP address to ensure that APs always have an active IP address with which to terminate sessions.</p>

Parameter	Description
Backup LMS IPv6	This parameter specifies the IPv6 address of a <i>backup</i> to the IPv6 address specified with the <code>lms-ipv6</code> parameter.
LMS Preemption	When this parameter is enabled, the AP automatically reverts to the primary LMS IP address when it becomes available.
LMS Hold-down Period	Time, in seconds, that the primary LMS must be available before an AP returns to that LMS after failover.
<b>Remote AP System Profile Settings</b>	
Remote-AP DHCP Server VLAN	VLAN ID of the remote AP DHCP server used if the managed device is unavailable. This VLAN enables the DHCP server on the AP (also known as the remote AP DHCP server VLAN). If you enter the native VLAN ID, the DHCP server is unavailable.
Remote-AP DHCP Server ID	IP address used as the DHCP server identifier.
Remote-AP DHCP Default Router	IP address for the default DHCP router.
Remote-AP DHCP DNS Server	IP address of the DNS server.
Remote-AP DHCP Pool Start	Configures a DHCP pool for remote APs. This is the first IP address of the DHCP pool.
Remote-AP DHCP Pool End	Configures a DHCP pool for remote APs. This is the last IP address of the DHCP pool.
Remote-AP DHCP Pool Netmask	Configures a DHCP pool for remote APs. This is the netmask used for the DHCP pool.
Remote-AP DHCP Lease Time	The amount of days that the assigned IP address is valid for the client. Specify the lease in <days>. A value of 0 indicates the IP address is always valid; the lease does not expire.
Remote-AP uplink total bandwidth	This is the total reserved uplink bandwidth (in Kilobits per second).
Remote-AP bw reservation 1 Remote-AP bw reservation 2 Remote-AP bw reservation 3	Session ACLs with uplink bandwidth reservation in kilobits per second. You can specify up to three session ACLs to reserve uplink bandwidth. The sum of the three uplink bandwidths should not exceed the Remote-AP uplink total bandwidth .
Remote-AP Local Network Access	Enable or disable local network access across VLANs in a Remote-AP.
<b>Advanced AP System Profile Settings</b>	

Parameter	Description
Tunnel heartbeat interval	Set the interval between heartbeat messages between a remote or campus AP and its associated managed device. An increase in the heartbeat interval increases the time it will take for an AP to detect the loss in connectivity to the managed device, but can reduce internet bandwidth consumed by a remote AP. The supported range is 1-60 seconds, and the default value is 1 second.
LMS ping interval	Specifies the interval at which application level ping needs to be sent to primary managed device to check the reachability. Applicable only for RAP.  <b>NOTE:</b> If this parameter is changed, UDP session timeout on an intermediate router which performs NATing should be set accordingly. The preferred timeout value is (lms-ping-interval + 30sec). The supported range is 10-60 seconds, and the default value is 20 seconds.
Bootstrap threshold	Number of consecutive missed heartbeats on a GRE tunnel (heartbeats are sent once per second on each tunnel) before an AP reboots. On the managed device, the GRE tunnel timeout is 1.5 x bootstrap-threshold; the tunnel is torn down after this number of seconds of inactivity on the tunnel. The supported range is 1-65535, and the default value is 8.
Double Encrypt	This parameter applies only to remote APs. Use double encryption for traffic to and from a wireless client that is connected to a tunneled SSID.  When enabled, all traffic is re-encrypted in the IPsec tunnel. When disabled, the wireless frame is only encapsulated inside the IPsec tunnel.  All other types of data traffic between the managed device and the AP (wired traffic and traffic from a split-tunneled SSID) are always encrypted in the IPsec tunnel.
Dump Server	(For debugging purposes.) Specifies the server to receive a core dump generated when an AP process crashes.  <b>NOTE:</b> To allow the core dump files to be sent to the managed device instead of a dump server, access the managed device command-line interface and issue the command <b>ap-crash-transfer</b> .
Heartbeat DSCP	Assign a DSCP value to AP heartbeats to prioritize heartbeats traveling over low-speed links. The supported range is 0-63, and the default value is 0. For more information, see <a href="#">Prioritizing AP Heartbeats on page 543</a> .
Maintenance Mode	Enable or disable AP maintenance mode.  This setting is useful when deploying, maintaining, or upgrading the network.

Parameter	Description
	If enabled, APs stop flooding unnecessary traps and syslog messages to network management systems or network operations centers when deploying, maintaining, or upgrading the network. The controller still generates debug syslog messages if debug logging is enabled.
Maximum Request Retries	Maximum number of times to retry AP-generated requests, including keepalive messages. After the maximum number of retries, the AP either tries the IP address specified by the <code>bkup-lms-ip</code> (if configured) or reboots.
Request Retry Interval	Interval, in seconds, between the first and second retries of AP-generated requests. If the configured interval is less than 30 seconds, the interval for subsequent retries is increased up to 30 seconds.
Number of IPSEC retries	Number of times the AP will try to create an IPsec tunnel with the master controller before the AP will reboot. If you specify a value of 0, and AP will not reboot if it cannot create the IPsec tunnel. The supported range of values is 0-1000 retries, and the default value is 85 retries.
AeroScout RTLS Server	Enables the AP to send AeroScout tag information to an RTLS server. You must specify the IP address or DNS server and port number of the server to which location reports are sent.  RTLS station reporting includes information for APs and the clients that the AP has detected. If you select the <b>Include Unassociated Stations</b> option, the station reports will also include information about clients not associated to any AP. By default, unassociated clients are not included in station reports.
IPorDNS	IP address or the DNS of the AeroScout server to which location reports are sent.
Port	Port number on the AeroScout server to which location reports are sent.
includeUnassocSta	If you select the <b>Include Unassociated Stations</b> option, the station reports will also include information about clients not associated to any AP. By default, unassociated clients are not included in station reports.
RTLS Server configuration	Enables the AP to send RFID tag information to an RTLS server. You must specify the IP address or DNS server and port number of the server to which location reports are sent, a shared secret key, and the frequency at which packets are sent to the server.  RTLS station reporting includes information for APs and the clients that the AP has detected. For more information on configuring RTLS server configuration, see <a href="#">Defining an RTLS Server on page 518</a> .
IPorDNS	IP address or the DNS of the RTLS server to which location reports are sent.

Parameter	Description
Port	RTLS server port number
frequency	Specify how often to send station RSSI update messages to the server.. The supported range is 1-3600 seconds, and the default setting is 30 seconds.
key	Shared secret key for the RTLS server.
Include Unassociated Stations	If you select the <b>Include Unassociated Stations</b> option for an RTLS server, the station reports will also include information about clients not associated to any AP. By default, unassociated clients are not included in station reports.
RTLS Server Compatibility Mode	The compatibility mode controls the format of tag frames forwarded to the RTLS server. Enabling this mode will enable legacy format (includes a 2 byte padding), and disabling this mode will remove the padding. The tag frame format will be the same across all AP models. This feature is enabled by default
Slow Timer Recovery by rebooting itself	If you enable this option, ArubaOS checks for a slow CPU timer, and if it detects an issue, restarts the AP without logging a reason for the reboot. This feature is supported on AP-103H, and RAP-108/ RAP-109 access points.
Telnet	Select this check box to enable telnet to the AP.
Console Enable	Enable console port on the AP.
AP Console Protection	Enable the AP console protection by requiring a password to get AP console access.
AP Console Password	Sets the AP console password on the controller. If configured, you must enter this password to get AP console access. If not configured, the controller generates a default random password which can be viewed by executing the <b>encrypt disable</b> command followed by the <b>show ap system-profile &lt;profile-name&gt;</b> command. To disable the AP console password, execute the <b>shell-passwd passworddisabled</b> command.  <b>NOTE:</b> The <b>passworddisabled</b> is a special character string. On entering this string, the controller disables the AP console password.
Password for Backup	Allows client access to adjust the band and mode settings for the backup ESSID.
AP USB Power override	Enabling override enables the USB port of the AP with POE AT power.  <b>NOTE:</b> This parameter is applicable for AP-205H access point only.

Parameter	Description
RF Band for Backup	<p>Band on which the controller broadcasts the backup ESSID. Supported values are as follows:</p> <ul style="list-style-type: none"> <li>• <b>a</b>: 802.11a</li> <li>• <b>all</b>: all bands. This is the default setting.</li> <li>• <b>g</b>: 802.11g</li> </ul>
Operation for Backup	<p>This parameter allows AP console access using a backup ESSID, allowing users to access an AP console after the AP has disconnected from the controller. When the AP advertises a backup ESSID in either static or dynamic mode, a user is able to access and debug the AP remotely through a virtual AP.</p> <p>The default setting for this feature is <b>off</b>. Select <b>dynamic</b> or <b>static</b> to enable this feature and select the mode by which the controller broadcasts the backup ESSID.</p>
BLE Endpoint URL	URL of the Meridian server to which the BLE sends monitoring data.
BLE Auth Token	The Bluetooth Low Energy (BLE) endpoint authorization token is a text string of 1-255 characters used by the BLE to authorize to and securely communicate with the Beacon Management Console. This token is unique for each deployment.
BLE Operation Mode	<p>Determines how the built-in Bluetooth Low Energy (BLE) chip in the AP functions. BLE chip can be in one of the following four modes:</p> <ul style="list-style-type: none"> <li>• <b>Beaconing</b>: The AP's built-in BLE chip functions as an iBeacon combined with beacon management functionality.</li> <li>• <b>Disabled</b>: The AP's built-in BLE chip is turned off. This is the default setting.</li> <li>• <b>Dynamic Console</b>: The AP's built-in chip functions as a regular iBeacon combined with beacon management functionality. However, when the link to the controller is lost, the built-in chip temporarily enables access to the AP console over BLE. This state of the BLE device may be rolled back to any of the other modes if the AP receives a different configuration setting for the <b>ble-op-mode</b> parameter from the new LMS.</li> <li>• <b>Persistent Console</b>: The AP's built-in chip provides access to the AP console over BLE using a mobile application. This functionality is the superset of the <b>Beaconing</b> mode.</li> </ul> <p><b>NOTE:</b> BLE is disabled for ArubaOS FIPS.</p>
Health Check	The AP Health check feature uses ping probes to check reachability and latency levels for the connection between the AP and the controller.
mode	Ping probe mode is the only mode currently supported by this feature.



Parameter	Description
packetsize	The size, in bytes, of a ping datagram. The supported range of values is 10-2000.
burstcnt	Number of probes to be sent during the probe frequency interval defined by the <b>frequency</b> health-check parameter. The supported range of values is 1-16.
freq	Probe interval, in seconds. The WAN health-check feature sends the number of probes defined by the <b>burst-size</b> parameter during each frequency interval defined by this <b>frequency</b> parameter. The supported range of values is 10-300.
report	Number of seconds between health check reports sent from the AP to the controller. The supported range of values is 60-3600.
retrycnt	Number of times the attempts to resend a probe. The supported range of values is 1-10 retry attempts.
AirMatch Report Period	Change the frequency period which AirMatch starts measuring the RF environment. The default value is 30 minutes, and the supported range of values is 5-180 minutes.
AirMatch Measurement Duration	Change the AirMatch RF measurement duration from the default value of five minutes to any value from 5-60 minutes. A value of 0 disables AirMatch RF environment measurements.
AirMatch Report Enabled	Enable or disable AirMatch reports. Each AP in a Mobility Master deployment measures its RF environment for a five minute duration, every 30 minutes. Mobility Master uses this information to compute an optimal solution, then deploys the latest RF plan by sending updated settings to the APs every 24 hours. This feature is enabled by default.

### In the CLI

The following command configures the AP system profile in the command-line interface.

```
(host) [node] (config) #ap system-profile <profile>
```

## Configuring the AP Wired Port Profile

This profile is only applicable to APs with Ethernet ports. Use this profile to enable or disable the wired port, define an AAA profile for wired port devices, and associate the port with an Ethernet link profile that defines its speed and duplex values. Basic AP wired port settings can be configured via the WebUI, while some additional advanced settings are available in the command-line interface.

### In the WebUI

1. Navigate to the **Configuration > System > Profiles** page.
2. Select **AP > AP Wired Port** , and select the AP wired port profile you want to modify. The parameters for the profile are described in [Table 106](#).

**Table 109: AP Wired Port Profile Parameters**

Parameter	Description
Shut down	Disable the wired AP port.
Remote AP Backup	Enable this option to use the wired port on a Remote AP for local connectivity and troubleshooting when the AP cannot reach the managed device. If the AP is not connected to the managed device, no firewall policies will be applied when this option is enabled. (The AAA profile will be applied when the AP is connected to managed device).
Bridge Role	Role that is assigned to a user if split-tunnel authentication fails.
Time to wait for authentication to succeed	Authentication timeout value, in seconds, for devices connecting the AP's wired port. The supported range is 1-65535 seconds, and the default value is 20 seconds.
Spanning Tree:	Enables the spanning-tree protocol.
Portfast:	Enables portfast for AP wired access ports. Spanning tree must be enabled before this command can be used.
Portfast on trunk:	Enables portfast for AP wired trunk ports. Spanning tree must be enabled before this command can be used.

### In the CLI

The following command configures the AP wired port profile in the command-line interface.

```
(host) [node] (config) #ap wired-port-profile <profile>
```

## 2.4 Ghz and 5 Ghz Radio RF Management

The two 802.11a and 802.11g RF management profiles for an AP configure its 802.11a (5 Ghz) and 802.11b/g (2.4 GHz) radio settings. You can either use the "default" version of each profile, or create a new 802.11a or 802.11g profile using the procedures below. Each RF management radio profile includes a reference to an Adaptive Radio Management (ARM) profile. If you would like ARM to dynamically select the best channel and transmission power for the radio, verify that the RF management profile references an active and enabled ARM profile. It can be useful to set the **Max Tx EIRP** parameter in the ARM profile to 127 (the maximum power level permissible) until it determines the signal-to-noise ratio on the links. If ARM is active, the **Max Tx EIRP** can also be set to 127 to allow maximum power levels.

If you want to manually select a channel for each AP group, create separate 802.11a and 802.11g profiles for each AP group and assign a different transmission channel for each profile. For example, one AP group could have an 802.11a profile that uses channel 36 and an 802.11g profile that uses channel 11, and another AP group could have an 802.11a profile that uses channel 40 and an 802.11g profile that uses channel 9.

With the implementation of the high-throughput 802.11n standard, 40 MHz channels were added in addition to the existing 20 MHz channel options. Available 20 MHz and 40 MHz channels are dependent on the country code entered in the regulatory domain profile. The newer very high-throughput (VHT) 802.11ac standard introduces 80 MHz channel options.



Changing the country code causes the valid channel lists to be reset to the defaults for the country.

## Managing 2.4 GHz and 5 GHz Radio Settings

Use the following procedures to define and manage 802.11a and 802.11g RF management profiles Using the WebUI.

### In the WebUI

1. In the **Managed Network** node hierarchy, navigate to the **Configuration > AP Groups** tab.
2. Select the name of an AP group from the AP groups tables.
3. Click the **Radio** tab below the AP groups tables to display the AP groups radio settings. The radio settings are divided into three sections, **Basic**, **Advanced** and **Client Control**. The profile parameters in each section are described in [Table 110](#).
4. Modify the desired settings, then click **Submit**.
5. Click **Pending Changes**.
6. In the **Pending Changes** window, select the check box and click **Deploy Changes**.

**Table 110:** 2.4 GHz and 5 GHz Radio Configuration Parameters

Parameter	Description
<b>Basic</b>	
Radio Mode	Access Point operating mode. Available options are: <ul style="list-style-type: none"><li>• <b>am-mode:</b> Air Monitor mode</li><li>• <b>ap-mode:</b> Access Point mode</li><li>• <b>spectrum-mode:</b> Spectrum Monitor mode</li></ul> The default settings is <b>ap-mode</b> .
Spectrum Monitoring	Select this option to convert APs using this radio profile to a hybrid APs that will continue to serve clients as an Access Point, but will also scan and analyze spectrum analysis data for a single radio channel. For more details on hybrid APs, see <a href="#">Spectrum Analysis on page 688</a> . This option is available only when radio mode is <b>ap-mode</b> .
Tx Power	Select the maximum and minimum transmission power levels for the radio in dBm. You can also set the maximum level to 127 for the regulatory maximum for that radio. Transmit power may be further limited by regulatory domain constraints and AP capabilities. This option is available only when radio mode is <b>ap-mode</b> .
Channel Width	The following channel width configurations are available in ArubaOS: <ul style="list-style-type: none"><li>• <b>20 Mhz:</b> A 20 MHz channel assignment consists of a single 20 MHz channel. This 20 channel assignment is valid for 802.11a/b/g and for 802.11n 20 MHz mode of operation.</li><li>• <b>40 Mhz:</b> A 40 MHz channel assignment consists of two 20 MHz channels bonded together (a bonded pair). This channel assignment is valid for 802.11n 40 MHz mode of operation and is most often utilized on the 5 GHz frequency band.</li></ul>

Parameter	Description
	<ul style="list-style-type: none"> <li>● <b>80 Mhz:</b> If you select this option, the AP radio supports channels assignments within the 20 Mhz, 40 Mhz and 80 Mhz bands.</li> </ul>
Valid 2.4 Ghz Channels Valid 5 Ghz Channels	Click <b>Edit</b> to select a group of supported transmit channels for the 2.4 Ghz and 5 Ghz radios. The available channels depend on the regulatory domain (country). The available channels may be limited by the Channel Width setting. This option is available only when radio mode is <b>ap-mode</b> .
Scan mode	<p>Air monitoring scan mode. Available options are:</p> <ul style="list-style-type: none"> <li>● <b>all-reg-domain:</b> Scan channels that belong to regulatory domain of any country</li> <li>● <b>rare:</b> Scan channels that do not belong to regulatory domain of any country</li> <li>● <b>reg-domain:</b> Scan channels that belong to regulatory domain of AP.</li> </ul> <p>The default settings is <b>all-reg-domain</b>. This option is available only when radio mode is <b>am-mode</b>.</p>
<b>Advanced</b>	
Interference Immunity	<p>Set a value for non-Wi-Fi Interference Immunity.</p> <p>The default setting for this parameter is level 2. When performance drops due to interference from non-802.11 interferers (such as DECT or Bluetooth devices), the level can be increased up to level 5 for improved performance. However, increasing the level makes the AP slightly "deaf" to its surroundings, causing the AP to lose a small amount of range.</p> <p>The levels for this parameter are:</p> <ul style="list-style-type: none"> <li>● Level 0: no ANI adaptation.</li> <li>● Level 1: noise immunity only.</li> <li>● Level 2: noise and spur immunity.</li> <li>● Level 3: level 2 and weak OFDM immunity.</li> <li>● Level 4: level 3 and FIR immunity.</li> <li>● Level 5: disable PHY reporting.</li> </ul>
Beacon Interval	Beacon Interval for the AP in msec. The supported range is 60-30000)msec, and the default value is 100 msec.
Enable CSA	Channel Switch Announcements (CSAs), as defined by IEEE 802.11h, enable an AP to announce that it is switching to a new channel before it begins transmitting on that channel. Enable this option to allow clients that support CSA to transition to the new channel with minimal downtime.
CSA Count	Number of channel switch announcements that must be sent prior to switching to a new channel. The default CSA count is 4 announcements.

Parameter	Description
Advertise 802.11d and 802.11h	Enable the radio to advertise its 802.11d (Country Information) and 802.11h (Transmit Power Control) capabilities. This option is disabled by default.
<b>Client Control</b>	
Client Match	Enable client match client bandsteering, load balancing and enhanced AP reassignment for roaming mobile clients. For more information on this feature, see <a href="#">ClientMatch Overview on page 441</a>

## In the CLI

```
[mynode] (config) #rf dot11a-radio-profile|dot11g-radio-profile <profile-name>
```

To view a complete list of 802.11a or 802.11g RF management profiles and their status:

```
[mynode]# show rf dot11a-radio-profile|dot11g-radio-profile
```

To view a complete list of 802.11a or 802.11g RF management profiles and their status:

```
[mynode]# show rf dot11a-radio-profile|dot11g-radio-profile
```

To view the settings of a specific RF management profile:

```
[mynode]# show rf dot11a-radio-profile|dot11g-radio-profile <profile-name>
```

## Managing High Throughput Radio Settings

Each radio references a high-throughput profile that manages that AP's 40Mhz tolerance settings. By default, a 5 Ghz radio uses a high-throughput profile named **default-a** and a 2.4 Ghz radio uses a high-throughput profile named **default-g**. If you do not want to use these default profiles, use the procedure below to reference a different high-throughput profile for your 802.11a or 802.11g RF management profiles. For more information on configuring these settings, see [High-Throughput APs on page 536](#).

## RF Optimization

Each AP includes an RF Optimization profile that allows you to configure settings for detecting interference. The controller can detect interference near a wireless client station or AP is based on an increase in the frame retry rate or frame receive error rate.

## Using the WebUI

1. Navigate to the **Configuration > System > Profiles** tab.
2. Select **RF Management** menu, then click **RF Optimization**.
3. Select the RF Optimization profile you want to edit or click **Add** and enter a name into the **Profile Name** dialog box to create a new profile.
4. Configure your RF Optimization radio settings then click **Submit**. [Table 111](#) describes the parameters

**Table 111: RF Optimization Profile Parameters**

Parameter	Description
Station Handoff Assist	Allows the controller to force a client off an AP when the RSSI drops below a defined minimum threshold. Default: Disabled
RSSI Falloff Wait Time	Time, in seconds, to wait with decreasing RSSI before a de-authorization message is sent to the client. Maximum value: 8 seconds Default : 4 seconds
Low RSSI Threshold	Minimum RSSI above which de-authorization messages should never be sent. Default: 10
RSSI Check Frequency	Interval, in seconds, to sample RSSI. Default: 3 seconds

### Using the CLI

Use the following command to configure RF Optimization profiles using the command-line interface

```
rf optimization-profile <profile>
```

### RF Event Configuration

An AP's event threshold profile configures Received Signal Strength Indication (RSSI) metrics, including high and low watermarks for frame error rates and frame retry rates. When certain RF parameters are exceeded, these events can signal excessive load on the network, excessive interference, or faulty equipment.



---

This profile and many of the detection parameters are disabled (value is 0) by default.

---

The following procedure details the steps to configure RF Event parameters.

### Using the WebUI

1. Navigate to the **Configuration > Controller > Profiles** tab.
2. Select **RF Management** menu, then click **RF Event Thresholds**.
3. Select the RF Event Thresholds profile you want to edit or click + and enter a name into the **Profile Name** dialog box to create a new profile.
4. (Optional) Click **General** then select **Detect Frame Rate Anomalies** to enable or disables detection of frame rate anomalies. This feature is disabled by default.
5. (Optional) Click **Advanced** to configure the parameters described detailed in [Table 112](#).
6. Click **Save**.

**Table 112: RF Event Thresholds Profile Parameters**

Parameter	Description
Bandwidth Rate High Watermark	If bandwidth in an AP exceeds this value, a bandwidth exceeded condition exists. The value represents the percentage of maximum for a given radio. (For 802.11b, the maximum bandwidth is 7 Mbps. For 802.11 a and g, the maximum is 30 Mbps.) The recommended value is 85%.
Bandwidth Rate Low Watermark	After a bandwidth exceeded condition exists, the condition persists until bandwidth drops below this value. The recommended value is 70%.
Frame Error Rate High Watermark	If the frame error rate (as a percentage of total frames in an AP) exceeds this value, a frame error rate exceeded condition exists. The recommended value is 16%.
Frame Error Rate Low Watermark	After a frame error rate exceeded condition exists, the condition persists until the frame error rate drops below this value. The recommended value is 8%.
Frame Fragmentation Rate High Watermark	If the frame fragmentation rate (as a percentage of total frames in an AP) exceeds this value, a frame fragmentation rate exceeded condition exists. The recommended value is 16%.
Frame Fragmentation Rate Low Watermark	After a frame fragmentation rate exceeded condition exists, the condition persists until the frame fragmentation rate drops below this value. The recommended value is 8%.
Frame Low Speed Rate High Watermark	If the rate of low-speed frames (as a percentage of total frames in an AP) exceeds this value, a low-speed rate exceeded condition exists. This could indicate a coverage hole. The recommended value is 16%.
Frame Low Speed Rate Low Watermark	After a low-speed rate exceeded condition exists, the condition persists until the percentage of low-speed frames drops below this value. The recommended value is 8%.
Frame Non Unicast Rate High Watermark	If the non-unicast rate (as a percentage of total frames in an AP) exceeds this value, a non-unicast rate exceeded condition exists. This value depends upon the applications used on the network.
Frame Non Unicast Rate Low Watermark	After a non-unicast rate exceeded condition exists, the condition persists until the non-unicast rate drops below this value.
Frame Receive Error Rate High Watermark	If the frame receive error rate (as a percentage of total frames in an AP) exceeds this value, a frame receive error rate exceeded condition exists. The recommended value is 16%.

Parameter	Description
Frame Receive Error Rate Low Watermark	After a frame receive error rate exceeded condition exists, the condition persists until the frame receive error rate drops below this value. The recommended value is 8%.
Frame Retry Rate High Watermark	If the frame retry rate (as a percentage of total frames in an AP) exceeds this value, a frame retry rate exceeded condition exists. The recommended value is 16%.
Frame Retry Rate Low Watermark	After a frame retry rate exceeded condition exists, the condition persists until the frame retry rate drops below this value. The recommended value is 8%.

## Using the CLI

Use the following command to configure RF event profiles. The available parameters for this profile are detailed in [Table 112](#).

```
rf event-thresholds-profile <profile>
```

## High-Throughput APs

With the implementation of the IEEE 802.11ac standard, very-high-throughput can be configured to operate on the 5 GHz frequency band. High-throughput (802.11n) can be configured on both the 5 GHz and 2.4 GHz frequency bands. High-throughput is enabled by default, and can be enabled or disabled in the 802.11a and 802.11g radio profiles. For details, see [2.4 Ghz and 5 Ghz Radio RF Management on page 530](#)

Two different profiles advanced define settings specific to high-throughput APs, the **high-throughput radio** profile and the **high-throughput SSID** profile. Use the **High-throughput radio** profile to configure your APs to advertise intolerance of 40 MHz operation. (By default, this option is disabled, and 40 MHz operation is allowed.) This profile also allows you to enable the **CSD Override** feature. When you turn on CSD override, CSD is disabled and only one antenna transmits data, even if they are being sent to high-throughput stations. The **High-throughput SSID** profile configures the high-throughput SSID settings for 802.11n.

You must create and modify a high-throughput radio or high-throughput SSID profile to change default values for an AP radio, such as activating features not enabled by default, disabling features that are enabled by default, or modifying default values for configuration settings.




---

Stations are not allowed to use high-throughput with TKIP stand-alone encryption, although TKIP can be provided in mixed-mode BSSIDs that support high-throughput. High-throughput is disabled on a BSSID if the encryption mode is stand-alone TKIP or WEP.

---

## Configuring Advanced High-Throughput Radio Settings

Most deployments do not require manual configuration of the high-throughput radio profile, however, you can configure advanced high-throughput radio profile settings using the WebUI or CLI interfaces

### In the WebUI

1. In the **Managed Network** node hierarchy, navigate to the **Configuration > System > Profiles** tab.
2. From the **All Profiles** window, expand the **RF Management** menu, then click **High-Throughput Radio**.
3. Select the High-Throughput Radio profile you want to edit or click + and enter a name into the **Profile Name** dialog box to create a new profile.
4. Configure the throughput settings described in [Table 113](#).



5. Click **Save**.
6. Click **Pending Changes**.
7. In the **Pending Changes** window, select the check box and click **Deploy Changes**.

**Table 113:** *High-Throughput Radio Profile Configuration Parameters*

Parameter	Description
honor 40MHz intolerance	When enabled, the radio will stop using the 40 MHz channels if the 40 MHz intolerance indication is received from another AP or station. Uncheck the <b>Honor 40 Mhz intolerance check box</b> to disable this feature.  Default: Enabled
CSD override	Most transmissions to high throughput (HT) stations are sent through multiple antennas using cyclic shift diversity (CSD). When you enable the <b>CSD Override</b> parameter, CSD is disabled and only one antenna transmits data, even if they are being sent to high-throughput stations. This enables interoperability for legacy or high-throughput stations that cannot decode 802.11n CDD data. This option is disabled by default, and should only be enabled under the supervision of Aruba technical support.  Use this feature to turn off antenna diversity when the AP must support legacy clients such as Cisco 7921g VoIP phones, or older 802.11g clients (e.g. Intel Centrino clients). Note, however, that enabling this feature can reduce overall throughput rates.

### In the CLI

```
(host) (config) #rf ht-radio-profile <profile>
(host) (config) #rf dot11a-radio-profile|dot11g-radio-profile <profile> high-throughput-enable
```

## Configuring Advanced High-Throughput SSID settings

Most deployments do not require manual configuration of the high-throughput SSID profile, however, you can configure advanced high-throughput SSID profile settings or modify default SSID profile values using the WebUI or CLI interfaces.




---

De-aggregation of MAC Service Data Units (A-MSDUs) is supported with a maximum frame transmission size of 4k bytes; however, this feature is always enabled and is not configurable. Aggregation is not currently supported.

---

### In the WebUI

1. In the **Managed Network** node hierarchy, navigate to the **Configuration > System > Profiles** tab.
2. Expand the **Wireless LAN** profiles menu.
3. Select **High-Throughput SSID**.
4. Select the High-Throughput SSID profile you want to edit or click + and enter a name into the **Profile Name** dialog box to create a new profile.
5. Configure the high-throughput SSID profile settings described in [Table 114](#).

**Table 114: High-Throughput SSID Profile Parameters**

Parameter	Description
<b>General</b>	
High throughput enable (SSID)	<p>Determines if this high-throughput SSID allows high-throughput (802.11n) stations to associate.</p> <p>Enabling high-throughput in an WLAN high-throughput SSID profile enables Wi-Fi Multimedia (WMM) base features for the associated SSID.</p> <p>Default: Enabled.</p>
40 MHz channel usage	<p>Enable or disable the use of 40 MHz channels. This parameter is enabled by default.</p> <p>Default: Enabled.</p>
Very High throughput enable (SSID)	<p>Enable or disable support for Very High Throughput (802.11ac) on the SSID.</p> <p>Default: Enabled.</p>
80 MHz channel usage (VHT)	<p>Enable or disable the use of 80 MHz channels on Very High Throughput (VHT) APs.</p> <p>Default: Enabled.</p>
<b>Multi User Transmit Beamforming</b>	
VHT - Multi User Transmit Beamforming	<p>Enable or disable VHT Multi-User Transmit Beamforming. If this parameter is disabled, all other Multi-User Transmit Beamforming configuration parameters have no effect.</p> <p>Default: Enabled.</p>
<b>Transmit Beamforming</b>	
VHT - Explicit Transmit Beamforming	<p>Enable or disable VHT Explicit Transmit Beamforming for the 802.11ac-capable APs. When this parameter is enabled, the AP requests information about the Multiple-Input and Multiple-Output (MIMO) channel and uses that information to transmit data over multiple transmit streams using a calculated steering matrix. The result is higher throughput due to improved signal at the beamforming (the receiving client). If this parameter is disabled, all other transmit beamforming settings will not take effect.</p> <p>Default: Enabled.</p>
<b>Advanced</b>	
BA AMSDU Enable	<p>Enable or disable Receive AMSDU in Block ACK (BA) negotiation. If enabled, AP denies clients from sending AMSDU using BA agreement.</p> <p>Default: Enabled.</p>

Parameter	Description
Temporal Diversity Enable	<p>When this setting is enabled and the client is not responding to 802.11 packets, the AP will launch two hardware retries; if the hardware retries are not successful then it attempts software retries.</p> <p>Default: Disabled.</p>
Legacy stations	<p>Control whether or not legacy (non-HT) stations are allowed to associate with this SSID. By default, legacy stations are allowed to associate. This setting has no effect on a BSS in which HT support is not available.</p> <p>Default: Enabled.</p>
Low-density Parity Check	<p>If enabled, the AP will advertise Low-density Parity Check (LDPC) support. LDPC improves data transmission over radio channels with high levels of background noise.</p> <p>Default: Enabled.</p>
Maximum number of spatial streams usable for STBC reception	<p>Control the maximum number of spatial streams usable for Space-Time Block Code (STBC) reception. 0 disables STBC reception, 1 uses STBC for MCS 0-7. Higher MCS values are not supported. (Supported on the AP-105, 130 Series, and AP-175 only. The configured value will be adjusted based on AP capabilities.)</p> <p>Default: 1.</p> <p><b>NOTE:</b> If transmit beamforming is enabled, STBC will be disabled for beamformed frames.</p>
Maximum number of spatial streams usable for STBC transmission.	<p>Control the maximum number of spatial streams usable for STBC transmission. 0 disables STBC transmission, 1 uses STBC for MCS 0-7. Higher MCS values are not supported. (Supported on AP-105, 130 Series, and AP-175 only. The configured value will be adjusted based on AP capabilities.)</p> <p>Default: 1.</p> <p><b>NOTE:</b> If transmit beamforming is enabled, STBC will be disabled for beamformed frames.</p>
MPDU Aggregation	<p>Enable or disable MAC Protocol Data Unit (MPDU) aggregation.</p> <p>High-throughput APs are able to send aggregated MAC protocol data units (MDPUs), which allow an AP to receive a single block acknowledgment instead of multiple ACK signals. This option, which is enabled by default, reduces network traffic overhead by effectively eliminating the need to initiate a new transfer for every MPDU.</p> <p>Default: Enabled.</p>
Max received A-MPDU size	<p>Control the maximum size, in bytes, of an Aggregated-MAC Packet Data Unit (A-MPDU) that can be received on this high-throughput SSID.</p>

Parameter	Description
	Default: 65535 bytes.
Max transmitted A-MPDU size	Control the maximum size, in bytes, of an A-MPDU that can be sent on this high-throughput SSID. Range: 1576–65535 bytes.
Min MPDU start spacing	Minimum time between the start of adjacent MPDUs within an aggregate MPDU, in microseconds. Range: 0 (No restriction on MPDU start spacing), .25 µsec, .5 µsec, 1 µsec, 2 µsec, 4 µsec. Default: 0.
Short guard interval in 20 MHz mode	Enable or disable use of short (400 ns) guard interval in 20 MHz mode.  A guard interval is a period of time between transmissions that allows reflections from the previous data transmission to settle before an AP transmits data again. An AP identifies any signal content received inside this interval as unwanted inter-symbol interference, and rejects that data. The 802.11n standard specifies two guard intervals: 400 ns (short) and 800 ns (long). Enabling a short guard interval can decrease network overhead by reducing unnecessary idle time on each AP. Some outdoor deployments, may, however require a longer guard interval. If the short guard interval does not allow enough time for reflections to settle in your mesh deployment, inter-symbol interference values may increase and degrade throughput.  Default: Enabled.
Short guard interval in 40 MHz mode	Enable or disable use of short guard interval (400 ns) in 40 MHz mode of operation.  Default: Enabled.
Short guard interval in 80 MHz mode	Enable or disable use of short guard interval (400 ns) in 80 MHz mode of operation.  Default: Enabled.
Supported MCS set	A list of Modulation Coding Scheme (MCS) values or ranges of values to be supported on this SSID. The MCS you choose determines the channel width (20 MHz vs. 40 MHz vs. 80 MHz) and the number of spatial streams used by the mesh node.  Range: 0–31.  Default: 0–31.  To specify a smaller range of values, enter a hyphen between the lower and upper values. To specify a series of different values, separate each value with a comma.

Parameter	Description
	<p>Examples: 2-10 1,3,6,9,12</p> <p>MCS value of 16-23 are supported on 130 Series/RAP-155/11ac APs only.</p> <p>MCS value of 24-31 are supported on 320 Series APs only.</p>
VHT - Supported MCS Map	<p>Comma separated list of maximum supported MCS for spatial streams 1 through 4. Valid values for maximum MCS are 7, 8, 9, and '-' (if spatial stream is not supported). Maximum MCS of a spatial stream cannot be higher than the previous streams. If an MCS is not valid for a particular combination of bandwidth and number of spatial streams, it will not be used for Tx and Rx.</p> <p>Default: 9,9,9,9.</p>
VHT - Transmit Beamforming Sounding Interval	<p>Time interval in milliseconds between channel information updates between the AP and the beamformee client.</p> <p>Default: 25 msec.</p> <p><b>NOTE:</b> This is applicable for 802.11ac-capable APs only.</p>
Maximum VHT MPDU size	<p>Maximum size of a VHT MPDU.</p> <p>Default: 11454 bytes.</p>
Maximum number of MSDUs in an A-MSDU on best-effort AC	<p>Set the maximum number of MSDUs in a TX A-MSDU on best effort AC.</p> <p>Default: 2.</p> <p><b>NOTE:</b> In tunnel and decrypt-tunnel forwarding mode, TX A-MSDU is disabled if the value is set to 0. If the value is set to non-zero, TX A-MSDU is enabled and set to this value.</p>

Parameter	Description
Maximum number of MSDUs in an A-MSDU on background AC	Set the maximum number of MSDUs in a TX A-MSDU on background AC.  Default: 2.  <b>NOTE:</b> TX A-MSDU is disabled if the value is set to 0. In decrypt-tunnel forwarding mode, TX A-MSDU on background AC is disabled and assigning any value has no effect.
Maximum number of MSDUs in an A-MSDU on video AC	Set the maximum number of MSDUs in a TX A-MSDU on video AC.  Default: 2.  <b>NOTE:</b> TX A-MSDU is disabled if the value is set to 0. In decrypt-tunnel forwarding mode, TX A-MSDU on video AC is disabled and assigning any value has no effect.
Maximum number of MSDUs in an A-MSDU on voice AC	Set the maximum number of MSDUs in a TX A-MSDU on voice AC.  Default: 0.  <b>NOTE:</b> TX A-MSDU is disabled if the value is set to 0. In decrypt-tunnel forwarding mode, TX A-MSDU on voice AC is disabled and assigning any value has no effect.

## In the CLI

```
(host) (config) #wlan ht-ssid-profile <profile-name>
```

## Validating and Optimizing AP Connectivity

The ArubaOS AP system profile contains multiple configuration settings to help you validate and optimize your AP connections to a controller.

This section includes the following information about these features:

- [AP Health Checks on page 542](#)
- [Optimizing AP Connections over Low-Speed Links on page 542](#)

### AP Health Checks

The AP Health check feature uses ping probes to check reachability and latency levels for the connection between the AP and the managed device. The recorded latency information appears in the output of the **show ap ip health-check** command. If the managed device IP address becomes unreachable from the AP uplink, this feature records the time that the connection failed, and saves that information in a log file (tmp/ap\_hcm\_log) on the AP.



This feature is disabled by default, and is enabled by selecting the Health Check option in the AP system profile. For details see [Configuring the AP System Profile on page 521](#)

### Optimizing AP Connections over Low-Speed Links

Depending on your deployment scenario, you may have APs or remote APs that connect to a managed device located across low-speed (less than 1 Mbps capacity) or high-latency (greater than 100 ms) links.

With low-speed links, if heartbeat or keep alive packets are not received between the AP and managed device during the defined interval, APs may reboot causing clients to re-associate. You can adjust the bootstrap threshold and prioritize AP heartbeats to optimize these types of links. In addition, high bandwidth applications may saturate low-speed links. For example, if you have tunnel-mode SSIDs, use them with low-bandwidth applications such as barcode scanning, small database lookups, and Telnet to avoid saturating the link. If you have traffic that will remain local, deploying remote APs and configuring SSIDs as bridge-mode SSIDs can also prevent link saturation.

With high-latency links, consider the amount and type of client devices accessing the links. Aruba APs locally process 802.11 probe-requests and probe-responses, but the 802.11 association process requires interaction with the managed device.

When deploying APs across low-speed or high-latency links, The following best practices are recommended:

- Connect APs and managed devices over a link with a capacity of 1 Mbps or greater.
- Maintain a minimum link speed of 64 Kbps per AP and per bridge-mode SSID. This is the minimum speed required for downloading software images.
- Adjust the bootstrap threshold to 30 if the network experiences packet loss. This makes the AP recover more slowly in the event of a failure, but it will be more tolerant to heartbeat packet loss.
- Prioritize AP heartbeats to prevent losing connectivity with the managed device.
- If possible, reduce the number of tunnel-mode SSIDs. Each SSID creates a tunnel to the managed device with its own tunnel keep alive traffic.
- If most of the data traffic will remain local to the site, deploy remote APs in bridging mode. For more information about remote APs, see [Access Points on page 496](#).
- If high-latency links such as transoceanic or satellite links are used in the network, deploy a managed device geographically close to the APs.
- If high-latency causes association issues with certain handheld devices or barcode scanners, check the manufacturer of the device for recent firmware and driver updates.

## Configuring the Bootstrap Threshold

To configure the bootstrap threshold via the WebUI, enter a value into the **bootstrap threshold** field in the advanced AP system profile settings. ( For details see [Configuring the AP System Profile on page 521](#)) To configure this setting via the command-line interface, issue the command **ap system-profile <profile> bootstrap-threshold <bootstrap-threshold>**.

## Prioritizing AP Heartbeats

To configure the AP heartbeat priority via the WebUI, enter a value greater than zero into the **Heartbeat DSCP** field in the advanced AP system profile settings. ( For details see [Configuring the AP System Profile on page 521](#)) To configure this setting via the command-line interface, issue the command **ap system-profile <profile> heartbeat-dscp <number>**.

## AP Channel Scanning

The scanning algorithm is enhanced to reduce the delay between visits to some channel types, by changing their scan priority.

## Channel Types and Priority

A channel can belong to one or more channel types, depending on regulatory information and the activity that is detected on the channel. The frequency of visits to a channel depends on the priority of the channel type(s) to which it belongs. The following table describes the priority of channel types.

**Table 115:** *Channel Types and Priority*

Channel Priority	Channel Type	Description
One	DOS Channels	Channels where the AP is actively containing one more rogue devices in AM mode are marked with an <b>O</b> flag in the ARM CLI output ( <code>show ap arm scan-times</code> ).
Two	Active Channels	Channels where AP or Station activity has already been detected are marked with an <b>A</b> flag in the ARM CLI output and are visited in all scan-modes.
Three	Reg-Domain Channels	Channels that are in the AP's regulatory domain are marked with a <b>C</b> flag in the ARM CLI output and are visited in all scan modes.
Four	All Reg-Domain Channels	Channels that belong to any country's regulatory domain are marked with a <b>D</b> flag in the ARM CLI output and are visited only if the <b>scan-mode</b> is set to <b>All-Reg</b> or <b>Rare</b> .
Five	Unconventional Scan Channels	This new channel type category contains channels that belong to any country's regulatory domain, but with an unconventional scan direction. These channels are marked with a <b>J</b> or <b>M</b> flag in the ARM CLI output and are visited only if <b>scan-mode</b> is set to <b>All-Reg</b> or <b>Rare</b> .
Six	Rare Channels	Channels that do not belong to any country's regulatory domain are marked with a <b>Z</b> flag in the ARM CLI output. Rare channel scanning is done in the AM mode only if the rare scan mode is selected in the <b>AM Scanning</b> profile.

The country code in the AP Regulatory Domain profile determines supported channel and channel pairs for that specific AP. If there is a change in the country code, the valid channel list is reset to the default value for that country.



---

Use the `show ap arm scan-times ap-name <ap_name>` command to show scan state and flags for each channel.

---

## Scanning Optimizations

The following optimizations enable the AP to achieve optimum RF monitoring. Unconventional Scans and Relative Priority of Channel Type Categories optimization apply to all AP types, but Channel Group Scanning optimization applies only to 200 Series models. All optimizations apply to AP and AM mode scanning.

### Unconventional (direction) Scans

- Unconventional scans are 40MHz scans of a channel in the direction away from the channel pair. For example, in the 44-48 channel pair:
  - Conventional scans will be 44+ and 48-
  - Unconventional scans will be 44- and 48+



- Unconventional scans are no longer interspersed with conventional scans. Unconventional scans operate with a lower frequency, because they belong to a new low priority channel type.
- Unconventional scans are performed in all-regulatory and rare scan modes. But these scans will not be performed if the scan mode is set to regulatory domain. This modification enables the AP to scan through active channels, regulatory channels, and all-regulatory channels faster.



---

Currently, 200 Series access points do not support unconventional or rare channel scanning.

---

## Modifications in Scan Frequency

A modification is introduced to increase the frequency of visits to active and regulatory domain channels. Channel type categories are:

- DOS
- Active
- Regulatory domain
- All-regulatory domain
- Unconventional or rare



---

Unconventional or rare channels are merged for scanning.

---

## Channel Group Scanning

Since a 11ac AP radio can hear frames sub-channels when it performs an 80MHz wide scan, scanning can be optimized by categorizing channels into scan groups, which are visited sequentially when a new primary channel is selected. This allows the AP scan through the list of channels faster, so that the delay between visits to channels in a group is reduced.

For more information on Channel Group Scanning, see [Channel Group Scanning on page 545](#)

## Channel Group Scanning

The following section describes channel group scanning:

- Channel groups can be 80MHz (4 channels), 40MHz (2 channels), or 20MHz wide (1 channel).
- Each channel is mapped to a group depending on the maximum width supported by that channel and the radio's capability. The maximum width supported by a channel is determined by the channel's membership in regulatory domain channel pairs or groups.
  - Channel 36, 40, 44, and 48 belong to 80MHz group
  - Channel 165 belongs to 20MHz group
- Channel groups are visited sequentially and the primary channel is rotated after each visit.
- Group scanning behavior is performed for 200 Series access points on A-band channels.



---

Scanning only once in each 80MHz wide group allows the AP to scan through the channel list faster and also hear frames on sub-channels.

---

## Managing AP Console Settings

An AP's provisioning parameters are unique to each AP. These parameters are initially configured on the Mobility Master and then pushed out to the AP and stored on the AP itself. Best practices are to configure an

AP's provisioning settings using the Mobility Master WebUI. If you find it necessary to alter an AP's provisioning settings for troubleshooting purposes, you can do so using the WebUI and CLI, or alternatively, through a console connection to the AP itself.

To create a console connection to the AP:

1. Connect a local console to the serial port on the AP. You can connect the AP's serial port to a terminal or terminal server using an Ethernet cable, or connect the serial console port to a DB-9 adapter, then connect the adapter to a laptop using an RS-232 cable. For details on connecting to an AP's serial console port, refer to the installation guide included with the AP.
2. Establish a console communication to the AP, then power-cycle the AP to reboot it.
3. To access the AP console command prompt, press **Enter** when the AP displays the message "Hit <Enter> to stop autoboot." If the autoboot countdown expires before you can interrupt it, turn the device off and then back on.
4. Once the AP boot prompt appears, enter the AP console password. You can issue any of the AP provisioning commands described in the [Table 116](#). Remember, though these commands may be useful for troubleshooting, they are all optional and are *not* necessary for normal AP provisioning.

**Table 116:** AP Boot Commands



The list of AP boot commands may vary based on the APBoot image version.

Command	Description
boot	Boot the ArubaOS image from flash or USB, using currently saved environment variables. Any unsaved changes to the variables will be lost. This command has the following sub-parameters: <ul style="list-style-type: none"> <li>• ap - Boot the ArubaOS image from flash.</li> <li>• usb:&lt;path&gt; - Boot the ArubaOS image from USB.</li> </ul>
clear	Clear the ArubaOS image or other information. This command has the following sub-parameters: <ul style="list-style-type: none"> <li>• all - Clear the cache and ArubaOS.</li> <li>• cache - Clear the cache sectors (mesh, RAP, CAP).</li> <li>• os &lt;n&gt; - Clear the image from the specified partition (default: 0).</li> <li>• prov - Clear provisioning image from the flash.</li> </ul>
dhcp	Invoke DHCP client to obtain IP/boot parameters.
factory_reset	Reset the AP to factory default.
flash	Upgrade the boot image. <b>NOTE:</b> Exercise caution when using this command.
help	Help text for the AP boot commands.
mfginfo	Shows manufacturing information of the AP.

Command	Description
osinfo	Shows the ArubaOS image information on the AP.
ping	Check network connectivity.
printenv	List the environment variables and their current settings. AP boot environment variables are configured using the AP boot <b>setenv</b> command,
purgeenv	Reinstate AP boot configuration to factory default. This includes restoring the default environment variables.
reset	Perform RESET of the AP CPU.
saveenv	Save environment variables to persistent storage.
setenv ipaddr <ipaddr>	IP address to be assigned to the AP.
setenv netmask <netmaskip>	Netmask to be assigned to the AP.
setenv gatewayip <ipaddr>	IP address of the internet gateway used by the AP.
setenv name <ap name>	Name of the AP.
setenv group <group name>	Name of the AP group to which the AP should belong.
setenv master <ipaddr>	IP address of the AP's master controller.
setenv serverip <ipaddr>	IP address of the TFTP server from which the AP can download its boot image.
setenv dnsip <ipaddr>	IP address of the DNS server used by the AP.
setenv domainname <domain>	Domain name used by the AP.
tftpboot	Boot ArubaOS image over the network using TFTP protocol.
upgrade	Upgrade the APBoot or ArubaOS image. This command has the following sub-parameters: <ul style="list-style-type: none"> <li>boot &lt;file&gt; - Upgrade the APBoot image from &lt;file&gt;.</li> <li>os [&lt;n&gt;] &lt;file&gt; - Upgrade the ArubaOS image in partition &lt;n&gt; from &lt;file&gt;.</li> <li>prov - Upgrade provisioning image from &lt;file&gt;.</li> </ul> <p><b>NOTE:</b> &lt;file&gt; can be a &lt;TFTP-server-IP&gt;:&lt;path&gt; or usb:&lt;path&gt;.</p>
version	Displays the APBoot image version.

- When you are finished, type **saveenv** and then press **enter** to save your settings



---

Other AP console commands may be available when accessing an AP directly through its console port, but these commands can cause configuration errors if used improperly and should only be issued under the direct supervision of Aruba technical support.

---

The example below configures an AP location and domain name using an AP console connection:

```
Hit <Enter> to stop autoboot: 0
apboot> <INTERRUPT>
apboot> setenv group corporate-2
apboot> setenv domainname mycompany.com
apboot> saveenv
apboot>boot
```

To view current AP settings using the AP console, issue the command **printenv <name>** where **<name>** is one of the variable names listed in [Table 116](#), such as **ipaddr**, **dnsip** or **gatewayip**.

```
apboot> printenv domainname
domainname=mycompany.com
```

## AP Console Password Protection

The ArubaOS AP console password feature helps protect systems that manage highly sensitive information, like financial and banking institutions, by requiring users to log in to the AP network with a password. The AP console password is enabled by default. Passwords must be 6 to 32 characters in length, and can include alphanumeric and special characters. If configured, you must enter this password to get AP console access. If not configured, the Mobility Master generates a default random password which can be viewed by executing the **encrypt disable** command followed by the **show ap system-profile <profile-name>** command.

The timeout feature is also supported as an added level of security. If there is no user input or activity during one timeout interval (default of 30 minutes), the user is logged out of the system. The timeout interval cannot be modified.

### Setting an AP Console Password

You can configure an AP console password using the managed device WebUI or CLI.

#### In the WebUI

To set a password in the WebUI:

- In the Managed Network node hierarchy, navigate to **Configuration > System** page.
- Select the **Profiles** tab.
- Expand the **AP profile** in the **All Profiles** list, then select **AP System**.
- Select the AP system profile you want to modify.
- Open the **Advanced** tab, check the **Console Enable** check box.
- In the **AP Console Password** field, enter the desired AP console password. Retype the password to confirm.
- In the **Password for Backup** field, enter the password backup password for the console. Retype the password to confirm.
- Click **Submit**.



---

Once the console is enabled, you do not need to enable it again. The console access is password protected.

---

## In the CLI

To set the AP console password in the CLI:

```
(host)[node] (config) #ap system-profile <profile>
(host)[node] (AP system-profile "<profile>") #console-enable
(host)[node] (AP system-profile "<profile>") #slow_timer_recovery
```

If the password is lost, and the AP is not connected to a managed device, the console can be reset using the reset button on the AP or the **factory\_reset** AP boot command. If it is already connected to a managed device, the AP password can be changed under the **AP Console Password** field of the **AP System** profile in the WebUI, or using the **ap-console-password** parameter of the **ap system-profile** command in the CLI.

## Disabling Access to the AP Console

Another way to protect your AP system is to completely disable access to the AP console under enabled mode.

### In the WebUI

To disable access to the console in the WebUI:

1. In the Managed Network node hierarchy, navigate to the **Configuration > System** page.
2. Select the **Profiles** tab.
3. Expand the **AP profile** in the **All Profiles** list, then select **AP System**.
4. Select the AP system profile you want to modify.
5. Open the **Advanced** tab, check the **Console Enable** check box.
6. Click **Save**.

### In the CLI

To disable access to the console in the CLI:

```
(host)[node] (config) #ap system-profile default
(host)[node] (AP system profile "default") #no console-enable
```

## Link Aggregation Support



---

Link aggregation is only supported by 220 Series, 270 Series and 320 Series access points.

---

All 220 Series, 270 Series, and 320 Series access points support link aggregation using either static port channel (configuration based) or Link Aggregation Control Protocol (protocol signaling based). These access points can optionally be deployed with LACP configuration to benefit from higher (greater than 1 Gbps) aggregate throughput capabilities.

The Mobility Master uses two different IP addresses for forwarding traffic to wireless clients associated to tunnel mode or decrypt-tunnel mode VAPs. One IP address is Mobility Master's IP address and the other is an unassigned IP address called GRE striping IP. Select the GRE striping IP address to ensure that a different physical interface is used by the load-balancing algorithm on the Ethernet switch. This enables the 220 Series, 270 Series, and 320 Series access points achieve greater than 1 Gbps throughput in both upstream and downstream directions.

On 200 Series and 270 Series access points, different IP addresses are used for different GRE tunnels between the AP and the LC. One LC IP address is used for tunnels corresponding to virtual APs using a 5G radio and the other LC IP address is used for tunnels corresponding to virtual APs using a 2.4G radio. By associating clients on both bands you can achieve more than 1 Gbps throughput.

On 320 Series access points, both IP addresses are used for GRE tunnels of virtual APs on 5G radio. By associating one 4x4 802.11ac client or multiple clients on you can achieve more than 1 Gbps throughput.

A local AP LACP LMS map information profile that maps a LMS IP address to a GRE striping IP address. If the AP fails over to a standby or backup Mobility Master, the AP LACP LMS map information profile on the new LC defines the striping IP address that the AP uses for link aggregation. This feature allows 220 Series, 270 Series, and 320 Series access points to continue to support link aggregation to a backup Mobility Master in the event of a Mobility Master failover, even if the backup Mobility Master is in a different L3 network.

In previous releases, the GRE striping IP address was defined in the global AP system profile, which did not allow APs to maintain GRE striping tunnels if the AP failed over to a backup Mobility Master in a different L3 network.



---

If your topology includes a backup Mobility Master you must define GRE striping IP settings in the active and the backup Mobility Master. For more information on LACP features in ArubaOS, see [Configuring LACP on page 159](#).

---

## Configuring LACP

To enable and configure LACP on 220 Series, 270 Series, and 320 Series access points, configure the **LMS IP** address and the **GRE Striping IP** address. In ArubaOS 6.4.2 and later, the GRE striping parameter is configured in the AP LACP Striping profile. In ArubaOS 6.3.1.0 to 6.4.1.x, GRE striping is configured in the **AP System profile**. The **GRE Striping IP** value must be an IPv4 address owned by the Mobility Master that has the specified **LMS IP**. The **GRE Striping IP** does not belong to any physical or virtual interface on the Mobility Master, but the Mobility Master can transmit or receive packets using this IP.

You can configure LACP features using the WebUI or the CLI.

### Using the WebUI

Follow the procedure to configure the LACP parameters in the AP System profile and AP LACP LMS map information profile:

1. In the Managed Network node hierarchy, navigate to the **Configuration > AP Groups** page.
1. Select an AP group then click the **More** tab.
2. Enter a unique IPv4 address in the **LMS IP address** field.
3. Enter a backup IPv4 address in the **Backup LMS IP address** field.
4. Enter a unique IPv6 address in the **LMS IPv6 address** field.
5. Enter a backup IPv6 address in the **Backup LMS IPv6 address** field.
6. Click **Submit**.

Use the following steps to enable LACP.

1. In the Managed Network node hierarchy, navigate to **Configuration > System**
2. **Profiles** and expand the **AP** profiles menu.
3. Select the **AP LACP LMS map information** profile.
4. Select the **AP LACP Striping IP** check box to enable the **AP LACP striping IP** feature.
5. Enter a GRE striping IP address in the **ip** field.
6. Enter a LMS IP address in the **lms** field.
7. Click **OK**.
8. Click **Save**.

### Using the CLI,

Execute the following commands to configure AP LACP and striping IP on HA standby or backup LMS:

```
(host)[node] (config) #ap system-profile LACP
(host)[node] (AP system-profile "LACP") #lms-ip 192.0.2.1
(host)[node] (AP system-profile "LACP") #bkup-lms-ip 192.0.77.1
(host)[node] (AP system-profile "LACP") #exit
(host)[node] (config) #ap-lacp-striping-ip
(host)[node] (AP LACP LMS map information) #striping-ip 192.0.2.2 lms 192.0.2.1
(host)[node] (AP LACP LMS map information) #aplacp-enable
```

Execute the following commands to configure AP LACP LMS on HA standby or backup LMS.

```
(bkup-host)[node] (config) #ap-lacp-striping-ip
(bkup-host)[node] (config) (AP LACP LMS map information) #striping-ip
    192.0.77.2 lms 192.0.2.1
(bkup-host) [node] (config) (AP LACP LMS map information) #aplacp-enable
```




---

If the **lms-ip** is not specified in the AP system profile, you can create an entry in **ap-lacp-striping-ip** profile with just the **striping-ip**.

---

## Important Points to Remember

- In the upstream direction when the AP transmits GRE frames to the Mobility Master the bonding driver must be in active-active mode and not in the default active-standby mode to allow link aggregation.
- If an AP's uplink access switch ports are configured in static port-channel mode, then the AP will set the Ethernet bonding mode to static port-channel (xor mode) only if **gre-striping-ip** is configured. If **gre-striping-ip** is not configured, then the AP goes back to **active-standby** mode. In this scenario, the AP may go down depending on the behavior of the upstream switch.
- If an AP's uplink access switch ports are configured in dynamic LACP mode, the AP detects LACP-PDUs and automatically sets the Ethernet bonding mode to LACP. If **gre-striping-ip** is not configured, then the AP's Ethernet bonding mode will continue to be in LACP mode, but the AP will send GRE traffic only through one Ethernet port.
- In AP-324/AP-325 access points, if AP uplink packet capture is taken, the downstream traffic will have sequence number in GRE header. Wireshark Aruba wlan decoder will not be able to decode these packets correctly since it looks for known Aruba GRE tunnel IDs.
- Ensure that the **gre-striping-ip** is unique and not used by any other host on the subnet.
- LACP support is limited to a use case where Enet 0 and Enet 1 ports of the AP are connected to a switch, and LACP is enabled on the two corresponding switch ports.
- The port priority is not applicable to the AP as both ports need to be used. This value is always set to the maximum numerical priority (0xFF), which is the lowest priority.
- The system priority is not configurable. It is set to the maximum numerical value (0xFFFF), which is the lowest priority. This leaves control of the aggregate to the upstream switch.
- The timeout value is not configurable.
- The key is not configurable and the default key value is 1.
- LACP cannot be enabled if wired AP functionality is enabled on the second port. You cannot enable LACP if the Enet 1 port is shutdown.

## Troubleshooting Link Aggregation

The following show commands in the CLI can be used to troubleshoot Link Aggregation on 220 Series, 270 Series, and 320 Series access points:

- **show ap debug lacp ap-name <ap-name>**—Using this command, you can view if LACP is active on an AP. It displays the number of GRE packets sent and received on the two Ethernet ports. Using this command with verbose option on AP-324/AP-325 access points displays packet re-ordering statistics of each wlan client.

- **show ap database**—Starting with ArubaOS 6.4.2, the output of this command includes an **LACP Striping** flag (s) to indicate if the AP is configured with a LACP striping IP address,
- **show datapath tunnel**—Using this command on 220 Series/270 Series access points, you can verify if the 2.4GHz tunnels are anchored on the **gre-striping-ip** (The GRE IDs for these tunnels are in a range between 0x8300 and 0x83F0). On AP-324/AP-325 access points, use the verbose option to verify that 5GHz tunnels have striping IP set in the column **StripIP** (The GRE IDs for these tunnels are in a range between 0x8200 and 0x82F0).
- **show datapath station**—On AP-324/AP-325 access points, using this command displays the LACP sequence number sent in the GRE header of the last packet to the client. This information is displayed under **Seq** column.
- **show ap remote debug anul-sta-entries**—On AP-324/AP-325 access points, using this command displays LAG enabled/disabled per station and data drops due to LAG packet reordering.
- **show datapath user**—Using this command, you can verify if the **gre-striping-ip** has an entry with the 'L' (local) flag
- **show datapath route-cache**—Using this command, you can verify if the **gre-striping-ip** has an entry with the LC MAC.

## Support for Port Bounce

Mobility Master provides support for the port bounce feature which enables a client to re-initiate a DHCP request when there is a VLAN change. This is achieved when a RADIUS server such as ClearPass Policy Manager sends Disconnect-Request with a Vendor Specific Attribute (VSA 40) to Mobility Master. Then, Mobility Master forwards the request to the device to trigger an interface shut down for a specified period. This allows the device to re-initiate a DHCP request for obtaining an IP address in the changed subnet.

The Disconnect-Request must include the following information:

- Calling Station-Id—MAC address of the user
- VSA—40
- Integer—0-60

VSA 40 represents **Aruba-Port-Bounce-Host**. The integer value indicates the time in seconds for which Mobility Master must shut the interface down. If the integer value received is 0 or a number greater than 60, Mobility Master does not shut the interface down.




---

During a port bounce, the client connected to the interface is removed from the user table and is added back after the port is up.

---

Execute the following command to view the security logs during and after a port bounce:

```
[mynode] #show log security all | include bounce
```

The following sample shows the output during a port bounce:

```
Sep 14 22:22:46 authmgr[539]: <124004> <DEBUG> |authmgr| Sending port bounce request for User
mac 34:e6:d7:24:c8:3b
Sep 14 22:23:22 authmgr[539]: <124004> <DEBUG> |authmgr| Port Bounce succeeded for User Mac
34:e6:d7:24:c8:3b
```



The Aruba secure enterprise mesh solution is an effective way to expand network coverage for outdoor and indoor enterprise environments without any wires. Using mesh, you can bridge multiple Ethernet LANs or you can extend your wireless coverage. As traffic traverses across mesh APs, the mesh network automatically reconfigures around broken or blocked paths. This self-healing feature provides increased reliability and redundancy: the network continues to operate if an AP stops functioning or a connection fails. Aruba managed devices provide centralized configuration and management for APs in a mesh environment; local mesh APs provide encryption and traffic forwarding for mesh links.

### Mesh Overview Information

The following topics in this chapter describes the components of the Aruba secure enterprise mesh architecture and profiles, as well as factors that should be taken into consideration when planning your mesh deployment.

- [Understanding Mesh Access Points on page 553](#)
- [Understanding Mesh Links on page 555](#)
- [Understanding Mesh Profiles on page 557](#)
- [Understanding Remote Mesh Portals \(RMPs\) on page 561](#)
- [Mesh Deployment Planning on page 565](#)
- [Mesh Deployment Solutions on page 563](#)
- [Mesh Deployment Planning on page 565](#)

### Mesh Configuration Procedures

The following topics describe the procedures required to configure your secure enterprise mesh solution:

1. [Creating and Editing Mesh Radio Profiles on page 571](#)
2. [Creating and Editing Mesh Radio Profiles on page 571](#)
3. [Creating and Editing Mesh High-Throughput SSID Profiles on page 576](#)
4. [Configuring Ethernet Ports for Mesh on page 582](#)
5. [Provisioning Mesh Nodes on page 585](#)
6. [Verifying Your Mesh Network on page 586](#)



---

Aruba strongly recommends staging mesh APs before deploying them. Identify the physical location of the APs, configure them for mesh, provision the APs and verify connectivity before physically deploying them in a live network.

---

If you are configuring an AP as both a remote access point and a mesh portal, see also [Configuring Remote Mesh Portals \(RMPs\) on page 588](#)

### Understanding Mesh Access Points

Mesh APs learn about their environment when they boot up. Mesh APs are either configured as a mesh portal (MPP), an AP that uses its wired interface to reach the managed device, or a mesh point (MP), an AP that establishes an all-wireless path to the mesh portal. Mesh APs locate and associate with their nearest neighbor,

which provides the best path to the mesh portal. Mesh portals and mesh points are also known as mesh nodes, a generic term used to describe APs configured for mesh.

A mesh radio's bandwidth can be shared between mesh-backhaul traffic and client traffic. You can, however, configure a radio for mesh services only. If you have a dual-radio AP, a mesh node can be configured to deliver client services on one radio, and both mesh and WLAN services to clients on the other. If you configure a single-radio AP to deliver mesh services only (by disabling the mesh radio in its 802.11a or 802.11g radio profile) that mesh node can not deliver WLAN services to its clients.

For mesh and traditional thin AP deployments, the Aruba Mobility Master provides centralized provisioning, configuration, policy definition, ongoing network management, and wireless and security services. However, unlike the traditional thin AP case, mesh nodes also perform network traffic encryption and decryption, and packet forwarding over wired and wireless links.

You configure the AP for mesh on the Mobility Master using either the WebUI or the CLI. All mesh related configuration parameters are grouped into mesh profiles that you can apply as needed to an AP group or to individual APs.

APs operate as thin APs by default; their primary function is to receive and transmit electromagnetic signals; other WLAN processing is left to the managed device. When planning a mesh network, you manually configure APs to operate in mesh portal or mesh point roles. Unlike a traditional WLAN environment, local mesh nodes provide encryption and traffic forwarding for mesh links in a mesh environment. Virtual APs are still applied to non-mesh radios.

Provisioning mesh APs is similar to thin APs; however, there are some key differences. Thin APs establish a channel to the managed device from which they receive the configuration for each radio interface. Mesh nodes, in contrast, get their radio interfaces up and running *before* making contact with the managed device. This requires a minimum set of parameters from the AP group and mesh cluster so the mesh node discovers a neighbor, and creates a mesh link and subsequent channel with the managed device. To do this, you must first define and configure the mesh cluster profile *before* configuring an AP to operate as a mesh node. This chapter first describes how to configure the mesh profile, then describes how to configure APs to operate in mesh mode. If you have already configured a complete mesh profile, continue to "Ethernet Ports for Mesh" or "Provisioning Mesh Nodes".

## Mesh Portals

The mesh portal (MP) is the gateway between the wireless mesh network and the enterprise wired LAN. You configure an Aruba AP to perform the mesh portal role, which uses its wired interface to establish a link to the wired LAN. You can deploy multiple mesh portals to support redundant mesh paths (mesh links between neighboring mesh points that establish the best path to the mesh portal) from the wireless mesh network to the wired LAN.

The mesh portal broadcasts the configured mesh service set identifier (MSSID/mesh cluster name), and advertises the mesh network service to available mesh points. Neighboring mesh points that have been provisioned with the same MSSID authenticate to the portal and establish a secure mesh link over which traffic is forwarded. The authentication process requires secure key negotiation, common to all APs, and the mesh link is established and secured using Advanced Encryption Standard (AES) encryption. Mesh portals also propagate channel information, including CSAs.

## Mesh Points

The mesh point (MP) is an Aruba AP configured for mesh and assigned the mesh point role. Depending on the AP model, configuration parameters, and how it was provisioned, the mesh point can perform multiple tasks. The mesh point provides traditional Aruba WLAN services (such as client connectivity, intrusion detection system (IDS) capabilities, user role association, LAN-to-LAN bridging, and Quality of Service (QoS) for LAN-to-mesh communication) to clients and performs mesh backhaul/network connectivity. A mesh radio can be

configured to carry mesh-backhaul traffic only. Additionally, a mesh point can provide LAN-to-LAN Ethernet bridging by sending tagged/untagged VLAN traffic across a mesh backhaul/network to a mesh portal.

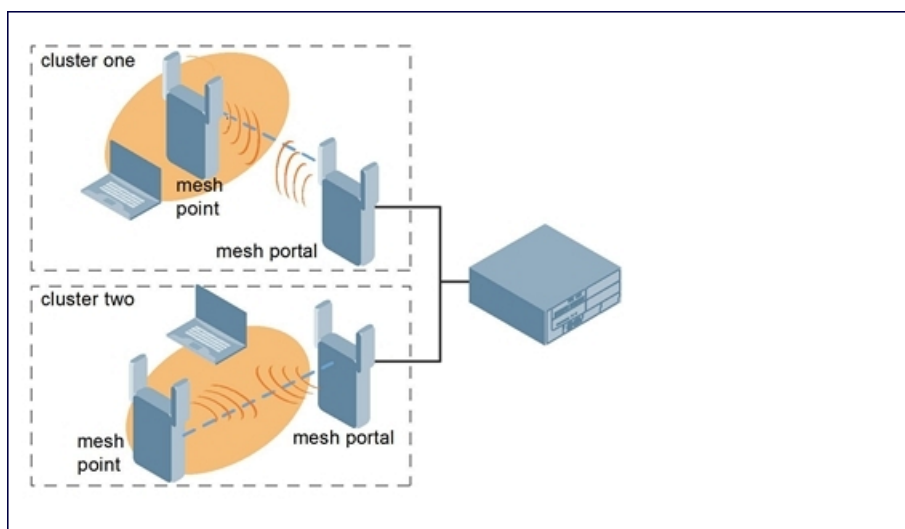
Mesh points use one of their wireless interfaces to carry traffic and reach the managed device. Mesh points are also aware of potential neighbors, and can form new mesh links if the current mesh link is no longer preferred or available.

## Mesh Clusters

Mesh clusters are similar to an Extended-Service Set (ESS) in a WLAN infrastructure. A mesh cluster is a logical set of mesh nodes that share the common connection and security parameters required to create mesh links. Mesh clusters are grouped and defined by a mesh cluster profile, as described in “Mesh Cluster Profile”.

Mesh clusters may enforce predictability in mesh networking by limiting the amount of concurrent mesh points, hop counts, and bandwidth used in the mesh network. A mesh cluster can have multiple mesh portals and mesh points that facilitate wireless communication between wired LANs. Mesh portals in a mesh cluster do not need to be on the same VLAN. [Figure 34](#) shows two mesh clusters and their relationship to the managed device.

**Figure 34** *Sample Mesh Clusters*



## Understanding Mesh Links

The mesh link is the data link between a mesh point and its parent. A mesh point uses the parameters defined in the mesh cluster profile, to establish a mesh link with a neighboring mesh point. The mesh link uses a series of metrics to establish the best path to the mesh portal.



---

Throughout the rest of this chapter, the term “uplink” is used to distinguish the active association between a mesh point and its parent.

---

The following list describes how mesh links are created:

- **Creating the initial mesh link**  
When creating the initial mesh link, mesh points look for others advertising the same MSSID as the one contained in its mesh cluster profile. The mesh point scans the channels in its provisioned band of operation to identify a list of neighbors that match its mesh cluster profile. The mesh point then selects the from highest priority neighbors based on the least expected path cost.

If no provisioned mesh cluster profile is available, mesh points use the recovery profile to establish an uplink. If multiple cluster profiles are configured, mesh points search, in order of priority, their list of provisioned backup mesh cluster profiles to establish an uplink. If the configured profiles are unavailable after searching for 5 minutes, the recovery profile is used.

- Moving to a better mesh link  
If the existing uplink quality degrades below the configured threshold, and a lower cost or more preferable uplink is available on the same channel and cluster, the mesh point reselects that link without re-scanning. In some cases, this invalidates all of the entries that have this mesh point as a next hop to the destination and triggers new learning of the bridge tables.
- Using a new mesh link if the current mesh link goes down  
If an uplink goes down, the affected mesh nodes reestablish a connection with the mesh portal by re-scanning to choose a new path to the mesh portal. If a mesh portal goes down, and a redundant mesh portal is available, the affected mesh nodes update their forwarding tables to reflect the path to the new mesh portal.

## Link Metrics

Mesh points use the configured algorithm to compute a metric value, or “path cost,” for each potential uplink and select the one with the lowest value as the optimal path to the mesh portal. [Table 117](#) describes the components that make up the metric value: node cost, hop count, link cost and 802.11 capacity.

The link metrics indicate the relative cost of a path to the mesh portal. The best path (lowest metric value) is used to create the uplink.

**Table 117:** Mesh Link Metric Computation

Component	Description
Node cost	Indicates the amount of traffic expected to traverse the mesh node. The more traffic, the higher the node cost. When establishing a mesh link, nodes with less traffic take precedence. The node cost is dependent on the number of children a mesh node supports. It can change as the mesh network topology changes, for example if new children are added to the network or old children disconnect from the network.
Hop count	Indicates the number of hops it takes the mesh node to get to the mesh portal. The mesh portal advertises a hop count of 0, while all other mesh nodes advertise a cumulative count based on the parent mesh node.
Link cost	Represents the quality of the link to an active neighbor. The higher the Received Signal Strength Indication (RSSI), the better the path to the neighbor and the mesh portal. If the RSSI value is below the configured threshold, the link cost is penalized to filter marginal links. A less direct, higher quality link may be preferred over the marginal link.  The following factors also affect mesh link metrics: <ul style="list-style-type: none"> <li>• High-throughput APs add a high cost penalty for links to non-high-throughput APs.</li> <li>• Multi-stream high-through APs add proportional cost penalties for links to high-throughput APs that support fewer streams.</li> </ul>

Component	Description
802.11 capacity	High-throughput APs can send 802.11 information elements (IEs) in their management frames, allowing high-throughput mesh nodes to identify other mesh nodes with a high-throughput capacity. High-throughput mesh points prefer to select other 802.11-capable mesh points in their path to the mesh portal, but can use a legacy path if no high-throughput path is available.
Path Cost	<p>Path cost is calculated by analyzing the other components in this table, and adding the link cost, the mesh parent's path cost, and the parent's node cost.</p> <p>Mesh portals typically advertise a path-cost of zero, but high-throughput portals add an offset penalty if they are connected to a 10/100mbps port that is too slow for the high-throughput link capacity.</p>

## Optimizing Links

You can configure and optimize operation of the link metric algorithm via the mesh radio profile. These configurable mesh link trigger thresholds can determine when the uplink or mesh path is dropped and another is chosen, provide enhanced network reliability, and contain flapping links. Although you can modify the behavior of the link metric algorithm, it is recommended to follow the default values for most deployments. For information, see [Metric algorithm on page 573](#).

## Understanding Mesh Profiles

Mesh profiles help define and bring-up the mesh network. The following sections describe the mesh cluster, mesh radio, and mesh recovery profiles in more detail.

The complete mesh profile consists of a mesh radio profile, RF management (802.11a and 802.11g) radio profiles, a high-throughput SSID profile (if your deployment includes 802.11n-capable APs), a mesh cluster profile, and a read-only recovery profile. The recovery profile is dynamically generated by the Mobility Master; you do not explicitly configure the recovery profile.

Aruba provides a “default” version of the mesh radio, RF management, high-throughput SSID and cluster profiles with default values for most parameters. You can use the “default” version of a profile or create a new instance of a profile which you can then edit as you need. You can change the values of any parameter in a profile. You have the flexibility of applying the “default” versions of profiles in addition to customizing profiles that are necessary for the AP or AP group to function.

If you assign a profile to an individual AP, the values in the profile override the profile assigned to the AP group to which the AP belongs. The exception is the mesh cluster profile: you can apply multiple mesh cluster profiles to individual APs, as well as to AP groups.

## Mesh Cluster Profiles

Mesh clusters are grouped and defined by a mesh cluster profile, which provides the framework of the mesh network. Similar to virtual AP profiles, the mesh cluster profile contains the MSSID (mesh cluster name), authentication methods, security credentials, and cluster priority required for mesh nodes to associate with their neighbors and join the cluster. Associated mesh nodes store this information in flash memory. Although most mesh deployments require only a single mesh cluster profile, you can configure and apply multiple mesh cluster profiles to an AP group or an individual AP. If you have multiple cluster profiles, the mesh portal uses the profile with the highest priority to bring up the mesh network. Mesh points, in contrast, go through the list of mesh cluster profiles in order of priority to decide which profile to use to associate themselves with the network. The mesh cluster priority determines the order by which the mesh cluster profiles are used. This

allows you, rather than the link metric algorithm, to explicitly segment the network by defining multiple cluster profiles.

Since the mesh cluster profile provides the framework of the mesh network, you must define and configure the mesh cluster profile before configuring an AP to operate as a mesh node. You can use either the **default** cluster profile or create your own. If you find it necessary to define more than one mesh cluster profile, you must assign priorities to each profile to allow the Mesh AP group to identify the primary and backup mesh cluster profile(s). The primary mesh cluster profile and each backup mesh cluster profile must be configured to use the same RF channel. The APs may not provision correctly if they are assigned to a backup mesh cluster profile with a different RF channel than the primary mesh cluster profile.

If the mesh cluster profile is unavailable, the mesh node can revert to the recovery profile to bring-up the mesh network until the cluster profile is available. You can also exclude one or more mesh cluster profiles from an individual access point, this prevents a mesh cluster profile defined at the AP group level from being applied to a specific AP.

Do not delete or modify mesh cluster profiles once you use them to provision mesh nodes. You can recover the mesh point if the original cluster profile is still available. It is recommended to create a new mesh cluster profile if needed. If you modify any mesh cluster setting, you must reprovision your AP for the changes to take effect (this also causes the AP to automatically reboot). See “Provisioning Mesh Nodes” for more information.

If you configure multiple cluster profiles with different cluster priorities, you manually override the link metric algorithm because the priority takes precedence over the path cost. In this scenario, the mesh portal uses the profile with the highest priority to bring-up the mesh network. The mesh portal stores and advertises that one profile to neighboring mesh nodes to build the mesh network. This profile is known as the “primary” cluster profile. Mesh points, in contrast, go through the list of configured mesh cluster profiles in order of priority to find the profile being advertised by the mesh portal. Once the primary profile has been identified, the other profiles are considered “backup” cluster profiles. Use this deployment if you want to enforce a particular mesh topology rather than allowing the link metric algorithm to determine the topology.

For this scenario, do the following:

- Configure multiple mesh cluster profiles with different priorities. The primary cluster profile has a lower priority number, which gives it a higher priority.
- Configure the mesh radio profile.
- Create an AP group for 802.11 a radios and 802.11 g radios
- Configure the 802.11 a or 802.11 g RF management profiles for each AP group.
- If your deployment includes high-throughput APs, configure the mesh high-throughput SSID profile. The mesh radio profile uses the default high-throughput SSID profile unless you specifically configure the mesh radio profile to use a different high-throughput SSID profile
- Create an AP group for each 802.11 a channel.

If a mesh link breaks or the primary cluster profile is unavailable, mesh nodes use the highest priority backup cluster profile to re-establish the uplink or check for parents in the backup profiles. If these profiles are unavailable, the mesh node can revert to the recovery profile to bring up the mesh network until a cluster profile is available. For information about the procedure to configure a mesh cluster profile, see [Configuring Mesh Cluster Profiles on page 567](#)

## Mesh Radio Profiles

The mesh radio profile allows you to specify the set of rates used to transmit data on the mesh link. This profile also allows you to define a **reselection-mode** setting to optimize the operation of the link metric algorithm. The reselection mode specifies the method a mesh node uses to find a better uplink to create a path to the mesh portal. Only neighbors on the same channel in the same mesh cluster are considered.

The mesh radio profile includes the following reselection mode options:

- **reselect-anytime:** mesh points using the **reselect-anytime** reselection mode perform a single topology readjustment scan within 9 minutes of startup and 4 minutes after a link is formed. If no better parent is found, the mesh point returns to its original parent. This initial scan evaluates more distant mesh points before closer mesh points, and incurs a dropout of 5–8 seconds for each mesh point. After the initial startup scan is completed, connected mesh nodes evaluate mesh links every 30 seconds. If a mesh node finds a better uplink, the mesh node connects to the new parent to create an improved path to the mesh portal.
- **reselect-never:** connected mesh nodes do not evaluate other mesh links to create an improved path to the mesh portal.
- **startup-subthreshold:** mesh points using the **startup-subthreshold** reselection mode perform a single topology readjustment scan within 9 minutes of startup and 4 minutes after a link is formed. If no better parent is found, the mesh point returns to its original parent. This initial startup scan evaluates more distant mesh points before closer mesh points, and incurs a dropout of 5–8 seconds for each mesh point. After that time, each mesh node evaluates alternative links if the existing uplink falls below the configured threshold level (the link becomes a sub-threshold link). It is recommended to use this default **startup-subthreshold** value.
- **subthreshold-only:** connected mesh nodes evaluate alternative links only if the existing uplink becomes a sub-threshold link.

If a mesh point using the **startup-subthreshold** or **subthreshold-only** mode reselects a more distant parent because its original, closer parent falls below the acceptable threshold, then as long as that mesh point is connected to that more distant parent, it seeks to reselect a parent at the earlier, shorter distance (or less) with good link quality. For example, if a mesh point disconnects from a mesh parent 2 hops away and subsequently reconnects to a mesh parent 3 hops away, then the mesh point continues to seek a connection to a mesh parent with both an acceptable link quality and a distance of two hops or less, even if the more distant parent also has an acceptable link quality.

For information about the procedure to configure mesh radio profiles, see [Creating and Editing Mesh Radio Profiles on page 571](#).

## RF Management (802.11a and 802.11g) Profiles

The two 802.11a and 802.11g RF management profiles for an AP configure its 802.11a (5 GHz) and 802.11b/g (2.4 GHz) radio settings. Use these profile settings to determine the channel, beacon period, transmit power, and ARM profile for a mesh AP's 5 GHz and 2.4 GHz frequency bands. You can either use the "default" version of each profile, or create a new 802.11a or 802.11g profile which you can then configure as necessary. Each RF management profile also has a **radio-enable** parameter that allows you to enable or disable the AP's ability to simultaneously carry WLAN client traffic and mesh-backhaul traffic on that radio. This value is enabled by default. For information about configuring RF Management Radio profiles, see [2.4 Ghz and 5 Ghz Radio RF Management on page 530](#).




---

If you do not want the mesh radios carrying mesh-backhaul traffic to support client traffic, consider using a dedicated 802.11a/802.11g radio profile with the mesh radio disabled. In this scenario, the radio carries mesh backhaul traffic but does not support client Virtual APs.

---

Mesh nodes operating in different cluster profiles can share the same radio profile. Conversely, mesh portals using the same cluster profile can be assigned different RF Management Radio profiles to achieve frequency separation (for more information, see "Deployments with Multiple Mesh Cluster Profiles").

## High-Throughput Radio Profiles

Each 802.11a and 802.11g radio profile also references a high-throughput profile that manages an AP or AP group's 40MHz tolerance settings. For information about referencing a high-throughput profile, see [Managing](#)

[High Throughput Radio Settings on page 533.](#)

## Mesh High-Throughput SSID Profiles

High-throughput APs support additional settings not available in legacy APs. A mesh high-throughput SSID profile can enable or disable high-throughput (802.11n) features and 40 MHz channel usage, and define values for aggregated MAC protocol data units (MDPUs), and Modulation and Coding Scheme (MCS) ranges.

Aruba provides a “default” version of the mesh high-throughput SSID profile. You can use the “default” version or create a new instance of a profile which you can then edit as you need. High-throughput mesh nodes operating in different cluster profiles can share the same high-throughput SSID radio profile. For information about configuring mesh high-throughput SSID profiles, see [Creating and Editing Mesh High-Throughput SSID Profiles](#).

## Wired AP Profiles

The wired AP profile controls the configuration of the Ethernet port(s) on your AP. You can use the wired AP profile to configure Ethernet ports for bridging or secure jack operation using the wired AP profile. For details, see [Configuring Ethernet Ports for Mesh on page 582](#)

## Mesh Recovery Profiles

In addition to the “default” and user-defined mesh cluster profiles, mesh nodes also have a recovery profile. The Mobility Master dynamically generates a recovery profile, and each mesh node provisioned by the same Mobility Master has the same recovery profile. The recovery profile is based on a pre-shared key (PSK), and mesh nodes use the recovery profile to establish a link to the managed device if the mesh link is broken and no other mesh cluster profiles are available.

The mesh portal advertises the provisioned cluster profile. If a mesh point is unaware of the active mesh cluster profile, but is aware of and has the same recovery profile as the mesh portal, the mesh point can use the recovery profile to connect to the mesh portal.

---

The mesh point must have the same recovery profile as the parent to which it connects. If you provision the mesh points with the same Mobility Master, the recovery profiles should match.



To verify that the recovery profile names match, use the following command:

```
show ap mesh debug provisioned-clusters {ap-name <name> | bssid <bssid> | ip-addr <ipaddr>}.
```

To view the recovery profile on the managed device, use the following command:

```
show running-config | include recovery.
```

---

If a mesh point connects to a parent using the recovery profile, it may immediately exit recovery if the parent is actively using one of its provisioned mesh cluster profiles. Once in recovery, a mesh point periodically exits recovery to see if it can connect using an available provisioned mesh cluster profile. The recovery profile is read-only; it cannot be modified or deleted.

The recovery profile is stored in the Mobility Master’s configuration file and is unique to that Mobility Master. If necessary, you can transfer your configuration to another managed device. If you do so, make sure your new mesh cluster is running and you have re-provisioned the mesh nodes before deleting your previous configuration. The APs learn the new recovery profile after they are provisioned with the new managed device. This is also true if you provision a mesh node with one Mobility Master and use it with a different Mobility Master. In this case, the recovery profile does not work on the mesh node until you re-provision it with the new Mobility Master.



## Understanding Remote Mesh Portals (RMPs)

You can deploy mesh portals to create a hybrid mesh/remote AP environment to extend network coverage to remote locations; this feature is called remote mesh portal, or RMP. The RMP feature integrates the functions of a remote AP (RAP) and the Mesh portal. As a RAP, it sets up a VPN tunnel back to the corporate switch that secures control traffic between the RAP and the switch.

The Remote Mesh Portal feature allows you to configure a remote AP at a branch office to operate as a mesh portal for a mesh cluster. Other mesh points belonging to that cluster get their IP address and configuration settings from the main office via an IPsec tunnel between the remote mesh portal and the Mobility Master. This feature is useful for deploying an all-wireless branch office or creating a complete wireless network in locations where there is no wired infrastructure in place.

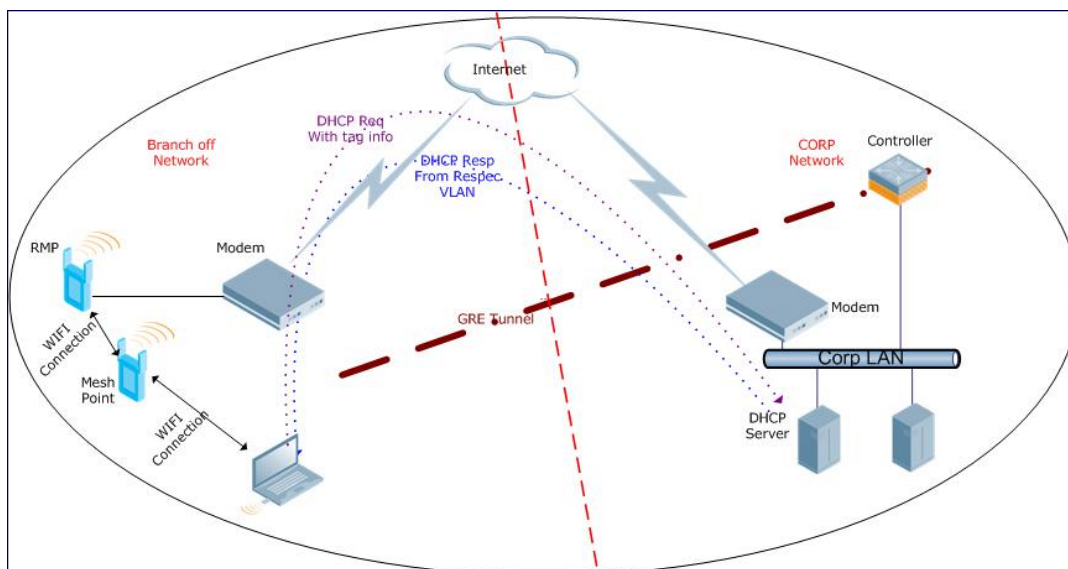
When the client at the branch office associates to a virtual AP in split-tunnel forwarding mode, the client's DHCP requests are forwarded over a GRE tunnel (split tunnel) to the corporate network. This communication is done over a secure VPN tunnel. The IPs are assigned from the corporate pool based on the VLAN tag information, which helps to determine the corresponding VLAN. The VLAN tag also determines the subnet from which the DHCP address has assigned.

A mesh point sends the DHCP request with the mesh private VLAN (MPV) parameter. The mesh point learns the MPV value from the response during the mesh association. When the split tunnel is setup for the RMP on the Mobility Master, the VLAN of the tunnel should be the MPV. A DHCP pool for the MPV should be setup on the switch. The use of MPV makes it easy for the RMP to decide which requests to forward over the split tunnel. All requests tagged with the MPV are sent over the split tunnel. Hence the MPV should be different from any user VLAN that is bridged using the mesh network.



The RMP configuration requires an AP license. For complete information on the licenses, refer to the *Aruba Mobility Master Licensing Guide*.

**Figure 35** Working of RMP



By default, the data frames the mesh portal receives on its mesh link are forwarded according to the bridge table entries on the portal. However, frames received on mesh private VLAN (MPV) are treated differently by the remote mesh portal. These frames are treated the same as frames received on a split SSID and are routed rather than bridged. Mesh points obtain DHCP addresses from the corporate network, then register with the managed device using these IP addresses. When these mesh points send and receive PAPI control traffic from

the Mobility Master, it controls these mesh points just as if they were on a local VLAN. PAPI traffic containing keys and other secret information receives IPsec encryption and decryption when it is forwarded to the managed device through the VPN tunnel.

Not all traffic from a mesh point is sent on the mesh private VLAN. When a mesh point bridges data received via its Ethernet interface or from clients connected to an access radio VAP, the mesh point does not tag the frame with the mesh private VLAN tag when it sends the data through mesh link to the remote mesh portal. Note that the mesh point may still tag the frame depending on the VLAN of the virtual AP and the native VLAN specified in the system profile. Care must be taken to assign the MPV value so that it does not clash with any local tags assigned in the mesh network. In this scenario, the portal performs the default operation and bridges the frame based on its bridge table. Traffic destined to the Internet is recognized as such by the remote mesh portal based on ACL rules. This traffic is NATed on the remote mesh portal's Ethernet interface.

For information on the procedure to configure remote mesh portals, see [Configuring Remote Mesh Portals \(RMPs\) on page 588](#)

## Understanding the AP Boot Sequence

The section describes the boot sequence for mesh APs in detail. Depending on its configured role, the AP performs a slightly different boot sequence.

### Booting the Mesh Portal

When the mesh portal boots, it recognizes that one radio is configured to operate as a mesh portal. It then obtains an IP address from a DHCP server on its Ethernet interface, discovers the Mobility Master on that interface, registers the mesh radio with the managed device, and obtains regulatory domain and mesh radio profiles for each mesh point interface. A mesh virtual AP is created on the mesh portal radio interface, the regulatory domain and radio profiles are used to bring up the radio on the correct channel, and the provisioned mesh cluster profile is used to setup the mesh virtual AP with the correct announcements on beacons and probe responses. On the non-mesh radio provisioned for access mode, that radio is a thin AP and everything on that interface works as a thin AP radio interface.

If the 802.11 a/802.11 g radio profile assigned to the mesh radio is enabled, the radio supports both mesh backhaul and client access Virtual APs. If the mesh radio is to be used exclusively for mesh backhaul traffic, associate that radio to a dedicated 802.11 a/802.11 g radio profile with the radio disabled so the mesh radios carry backhaul traffic only.

### Booting the Mesh Point

When the mesh point boots, it scans for neighboring mesh nodes to establish a link to the mesh portal. All of the mesh nodes that establish the link are in the same mesh cluster. After the link is up, the mesh point uses the DHCP to obtain an IP address and uses the same Mobility Master as their parent. The remaining boot sequence, if applicable, is similar to that of a thin AP. Remember, the priority of the mesh point is establishing a link with neighboring mesh nodes, not establishing a control link to a managed device.



---

In a single hop environment, the mesh point establishes a direct link with the mesh portal.

---

## Air Monitoring and Mesh

Each mesh node has an air monitor (AM) process that registers the BSSID and the MAC address of the mesh node to distinguish it from a thin AP. This allows the WLAN management system (WMS) on the managed node

and AMs deployed in your network to distinguish between APs, wireless clients, and mesh nodes. The WMS tables also identify the mesh nodes.

For all thin APs and mesh nodes, the AM identifies a mesh node from other packets monitored on the air, and the AM does not trigger wireless-bridging events for packets transmitted between mesh nodes.

## Mesh Deployment Solutions

You can configure the following single-hop and multi-hop solutions:

- Thin AP services with wireless backhaul deployment
- Point-to-point deployment
- Point-to-multipoint deployment
- High-availability deployment

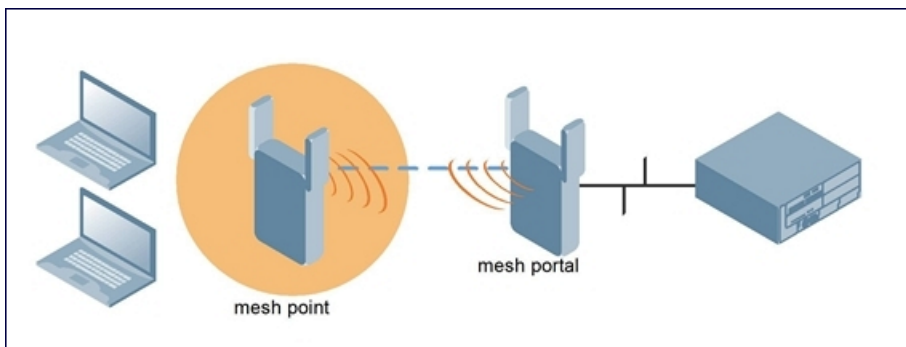
With a thin AP wireless backhaul deployment, mesh provides services and security to remote wireless clients and sends all control and user traffic to the Mobility Master over a wireless backhaul mesh link.

The remaining deployments allow you to extend your existing wired network by providing a wireless bridge to connect Ethernet LAN segments. You can use these deployments to bridge Ethernet LANs between floors, office buildings, campuses, factories, warehouses, and other environments where you do not have access to physical ports, or cable to extend the wired network. In these scenarios, a wireless backhaul carries traffic between the Aruba APs configured as the mesh portal and the mesh point, to the Ethernet LAN.

### Thin AP Services with Wireless Backhaul Deployment

To expand your wireless coverage without bridging Ethernet LAN segments, you can use thin AP services with a wireless backhaul. In this scenario, the mesh point provides network access for wireless clients and establishes a mesh path to the mesh portal, which uses its wired interface to connect to the managed device. Use the 802.11g radio for WLAN and managed device services and the 802.11a radio for mesh services. [Figure 36](#) shows the wireless backhaul between the mesh portal to the mesh point that services the wireless clients.

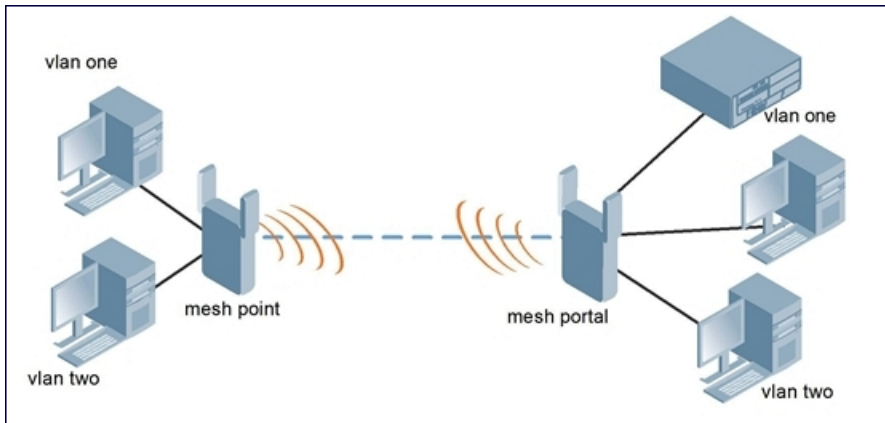
**Figure 36** *Sample Wireless Backhaul Deployment*



### Point-to-Point Deployment

In this point-to-point scenario, two Ethernet LAN segments are bridged via a wireless connection that carries both client services traffic and mesh-backhaul traffic between the mesh portal and the mesh point. This provides communication from one LAN to another. [Figure 37](#) shows a single-hop point-to-point deployment.

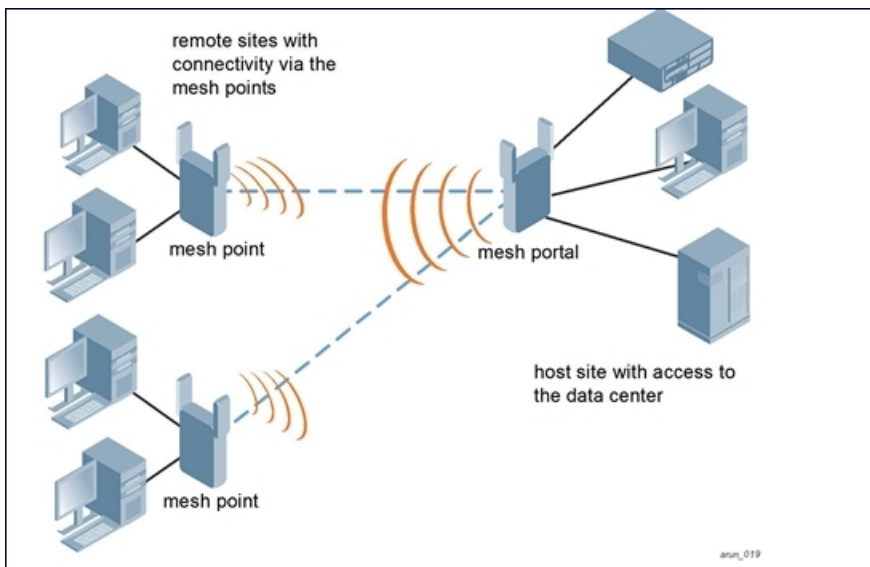
**Figure 37** Sample Point-to-Point Deployment



## Point-to-Multipoint Deployment

In a point-to-multipoint scenario, multiple Ethernet LAN segments are bridged via multiple wireless/mesh backhauls that carry traffic between the mesh portal and the mesh points. This provides communication from the local LAN to multiple remote LANs. [Figure 38](#) shows a single-hop point-to-multipoint deployment.

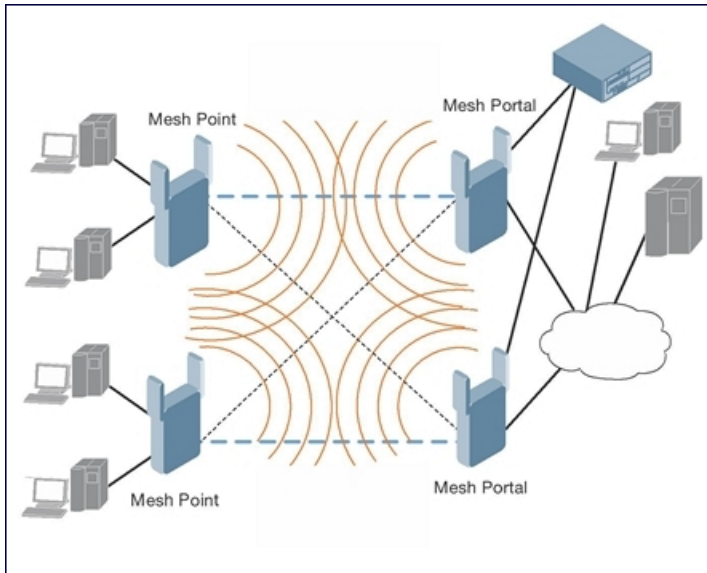
**Figure 38** Sample Point-to-Multipoint Deployment



## High-Availability Deployment

In this high-availability scenario, multiple Ethernet LAN segments are bridged via multiple wireless backhauls that carry traffic between the mesh portal and the mesh points. You configure one mesh portal for each remote LAN that you are bridging with the host LAN. This provides communication from the host LAN to multiple remote LANs. In the event of a link failure between a mesh point and its mesh portal, the affected mesh point could create a link to the other mesh portal. [Figure 39](#) shows a sample single-hop high-availability deployment. The dashed lines represent the current mesh link between the mesh points and their mesh portals. The diagonal dotted lines represent possible links that could be formed in the event of a mesh link or mesh portal failure.

**Figure 39** *Sample High-Availability Deployment*



## Mesh Deployment Planning

Following considerations are recommended when planning and deploying a mesh solution:

### Pre-Deployment Considerations

- Stage the APs before deployment. Identify the location of the APs, configure them for mesh, provision them, and verify connectivity before physically deploying the mesh APs in a live network.
- Ensure the Mobility Master has Layer-2/3 network connectivity to the network segment where you plan to install the mesh portal.
- Keep the AP packaging materials and reuse them to send the APs to the installation location.
- Verify the layout of the physical location to determine the appropriate configuration and placement of the APs. Use this information to avoid problems that would necessitate a physical recovery.
- Label the AP before sending it to the physical location for installation.

### Outdoor-Specific Deployment Considerations

- Provision the AP with the latitude and longitude coordinates of the installation location. This allows you to more easily identify the AP for inventory and troubleshooting purposes.
- Identify a “radio line of sight” between the antennas for optimum performance. The radio line of sight involves the area along a link through which the bulk of the radio signal power travels.
- Identify the minimum antenna height required to ensure a reliable mesh link.
- Scan your proposed site to avoid radio interference caused by other radio transmissions using the same or an adjacent frequency.
- Consider extreme weather conditions known to affect your location, including: temperature, wind velocity, lightning, rain, snow, and ice.
- Allow for seasonal variations, such as growth of foliage.

For more detailed outdoor deployment information, refer to the installation guide that came with your outdoor AP.

## Configuration Considerations

- On dual-radio APs, you can configure only one of the radio for mesh. If you want a dual-radio AP to carry mesh backhaul traffic and client services traffic on separate radios, it is recommended to use 802.11a radios for mesh-backhaul traffic and 802.11g radios for traditional WLAN access.
- If you configure more than one mesh node in the same VLAN, prevent network loops by enabling STP on the Layer-2 switch used to connect the mesh nodes.
- Mesh nodes learn a maximum of 1,024 source MAC addresses; this cannot be changed.
- Place all APs for a specific mesh cluster in the same AP group.
- Create and keep separate mesh cluster profiles for specific mesh clusters. Do not overwrite or delete the cluster profiles.
- Enable bridging on mesh point Ethernet ports when deploying LAN bridging solutions.
- APs configured as mesh points support secure jack operation on Enet0. APs with multiple Ethernet ports configured as mesh *portals* support secure jack operation on Enet1. If an AP with multiple Ethernet ports is configured as a mesh *point*, it supports secure jack operation on Enet1 and Enet0.
- Mesh networks forward tagged/untagged VLAN traffic, but do not tag traffic. The allowed VLANs are controlled by the wired ap profile.
- Mesh APs provisioned on different managed device can interoperate if those APs are configured with the same country code, cluster name and cluster key. However, the mesh recovery profile created on one managed device is not able to recover settings for mesh APs provisioned on another managed device unless the recovery profile is on Mobility Master and the other mesh nodes were provisioned by a managed device connected to that master.

## Post-Deployment Considerations

- Do not connect mesh point Ethernet ports in such a way that causes a network loop.
- Have a trained professional install the AP. After installation, check to ensure the AP receives power and boots up, enabling RSSI outputs.



---

Although the AP is up and operational, it is not connected to the network.

---

- Align the AP antenna for optimal RSSI.
- Do not delete or modify mesh cluster profiles once you use them to provision mesh nodes. You can recover the mesh point if the original cluster profile is still available. It is recommended to create a new mesh cluster profile if needed.
- If you create a new mesh cluster profile for an existing deployment, you must re-provision the AP for the new profile to take effect. If you re-provision mesh nodes that are already operating, re-provision the most distant (highest hop count) mesh points first, followed by the mesh portals. If you re-provision the mesh portal first, the mesh points may be unable to form a mesh link. Note that re-provisioning the AP causes it to automatically reboot, which may cause a disruption of service to the network.

## Dual-Port AP Considerations

A dual-port AP has two 10/100 Mbps Ethernet ports (Enet0 and Enet1, respectively). When using these APs in a mesh environment, note the following Ethernet port requirements:

- If configured as a mesh portal:
  - Connect Enet0 to the managed device to obtain an IP address. The wired AP profile controls Enet1.
  - Only Enet1 supports secure jack operation.
- If configured as a mesh point, Enet0 and Enet1 can be configured using separate wired-port-profiles

## Configuring Mesh Cluster Profiles

The mesh cluster configuration gets pushed from the controller to the mesh portal and the other mesh points, which allows them to inherit the characteristics of the mesh cluster of which they are a member. Mesh nodes are grouped according to a mesh cluster profile that contains the MSSID, authentication methods, security credentials, and cluster priority. Cluster profiles (including the **default** cluster profile) are not applied until you provision your APs for mesh. For more information on mesh cluster profiles, see [Mesh Cluster Profiles on page 557](#)

### Managing Mesh Cluster Profiles in the WebUI

Use the following procedures to define and manage mesh cluster profiles using the WebUI.

#### Creating a Profile

1. In the **Mobility Master** node hierarchy, navigate to **Configuration > System** and open the **Profiles** window.
2. Expand the **Mesh** tab in the **All Profiles** pane, then open the **Mesh Cluster profile** and select **Add profile**.
3. Enter a name for the new profile
4. Configure the mesh cluster settings described in [Table 118](#).

**Table 118:** Mesh Cluster Profile Configuration Parameters

Parameter	Description
Profile Name	Name of the mesh cluster profile. The name must be 1–63 characters. Default: Mesh cluster profile named “default.”
Cluster Name	Indicates the mesh cluster name. The name can have a maximum of 32 characters, and is used as the MSSID for the mesh cluster. When you first create a new mesh cluster profile, the profile uses the default cluster name “Aruba-mesh”. Use the Cluster Name parameter to define a new, unique MSSID before you assign APs or AP groups to the mesh cluster profile. <b>NOTE:</b> If you want a mesh cluster to use WPA2-PSK-AES encryption, do not use spaces in the mesh cluster name, as this may cause errors in mesh points associated with that mesh cluster. To view existing mesh cluster profiles, use the CLI command: show ap mesh-cluster-profile. A mesh portal chooses the best cluster profile and provisions it for use. A mesh point can have a maximum of 16 cluster profiles. Default: Mesh cluster named “Aruba-mesh.”
RF Band	Indicates the band for mesh operation for multiband radios. Select a or g. Important: If you create more than one mesh cluster profile for an AP or AP group, each mesh cluster profile must use the same band.

Parameter	Description
WPA Hexkey	Configures a WPA pre-shared key. This key must be 64 hexadecimal characters
WPA Passphrase	Sets the WPA password that generates the PSK. The passphrase must be between 8–63 characters, inclusive.
Encryption	Configures the data encryption, which can be either opensystem (no authentication or encryption) or wpa2-psk-aes (WPA2 with AES encryption using a preshared key). It is recommended to select wpa2-psk-aes and using the wpa-passphrase parameter to select a passphrase.  Default: opensystem.

5. Click **Submit**.
6. Click **Pending Changes**.
7. In the **Pending Changes** window, select the check box and click **Deploy Changes**.

### Associating a Mesh Cluster Profile to Mesh APs

Use the following procedure to associate a mesh cluster profile to a group of mesh APs or an individual mesh AP using the WebUI. If you configure multiple cluster profiles with different cluster priorities, you manually override the link metric algorithm because the priority takes precedence over the path cost. In this scenario, the mesh portal uses the profile with the highest priority to bring-up the mesh network.

1. In the **Managed Network** node hierarchy, navigate to **Configuration > Access Point** or **Configuration > AP Groups**.
2. Select an AP or AP group.
3. Click the **Profiles** tab.
4. Under the **Profiles** list, expand **Mesh**, and then select a **Mesh Cluster** profile.
5. In the profile details window pane, select a profile from the the **Mesh Cluster profile** drop-down list.
  - To add an existing mesh cluster profile to the selected AP or AP group, select a profile from the **Add a profile** drop-down list.
  - To create a new mesh cluster profile to the selected AP or AP group, click the **Add a profile** drop-down list and select **NEW**. Enter a name for the new mesh cluster profile.
6. Select a priority for the mesh cluster profile. The lower the number, the higher the priority.
7. Click **Submit**.
8. Click **Pending Changes**.
9. In the **Pending Changes** window, select the check box and click **Deploy Changes**.

The profile name appears in the mesh cluster profile list with your configured settings. If you configure this for the AP group, this profile also becomes the mesh cluster profile used by the mesh portal for your mesh network.

### Editing a Mesh Cluster Profile

If you modify any mesh cluster profile setting, you must reprovision your AP. For example, if you change the priority of a cluster profile from 5 to 2, you must reprovision the AP before you can assign priority 5 to another cluster profile. Reprovisioning the AP causes it to automatically reboot. For more information, see [Provisioning Mesh Nodes](#).

1. In the **Mobility Master** node hierarchy, navigate to **Configuration > System** and open the **Profiles** window.



- Expand the **Mesh** tab in the **All Profiles** pane, then open the **Mesh Cluster profile** and select the profile you want to edit.
- Change the mesh cluster settings as desired. [Table 118](#) describes the parameters you can configure for new and existing mesh clusters.




---

A mesh cluster profile configured with **wpa2-psk-aes encryption** must have a defined WPA hexkey or a WPA passphrase (or both). If you have configured one encryption type but not the other, and want switch from a hexkey to a passphrase or vice versa, you must add the new encryption type, click **Save**, then remove the encryption type you no longer want and click **Save** again. You cannot delete one encryption type and add a different type in a single step.

---

- Click **Submit**.
- Click **Pending Changes**.
- In the **Pending Changes** window, select the check box and click **Deploy Changes**.

### Deleting a Mesh Cluster Profile

You can delete a mesh cluster profile only if no APs or AP groups are associated with that profile.

- In the **Mobility Master** node hierarchy, navigate to **Configuration > System** and open the **Profiles** window.
- Expand the **Mesh** tab in the **All Profiles** pane, then open the **Mesh Cluster profile**.
- Click the **Delete** icon next to the name of the profile you want to delete.

### Managing Mesh Cluster Profiles in the CLI

You must be in config mode to create, modify or delete a mesh cluster profile using the CLI. Specify an existing mesh cluster profile with the <profile-name> parameter to modify an existing profile, or enter a new name to create an entirely new profile.

Configuration details and any default values for each of these parameters are described in [Table 118](#). If you do not specify a parameter for a new profile, that profile uses the default value for that parameter.

Use the **no** option before any parameter to remove the current value for that parameter and return it to its default setting. Enter **exit** to leave the mesh cluster profile mode.

```
(host) [mynode] (config) #ap mesh-cluster-profile <profile>
  clone <profile>
  cluster <name>
  no ...
  opmode [opensystem | wpa2-psk-aes]
  rf-band {a | g}
  wpa-hexkey <wpa-hexkey>
  wpa-passphrase <wpa-passphrase>
```

The following examples create and configure the mesh cluster profiles **cluster1** and **cluster2**.

```
(host) [mynode] (config) #ap mesh-cluster-profile cluster1
  cluster corporate
  opmode wpa2-psk-aes
  wpa-passphrase mesh_123
  rf-band a
(host) [mynode] (config) #ap mesh-cluster-profile cluster2
  cluster corporate
  opmode wpa2-psk-aes
  wpa-passphrase mesh_123
  rf-band a
```

You can also create a new mesh radio profile by copying the settings of an existing profile using the `clone` parameter. Using the **clone** command to create a new profile makes it easier to keep constant attributes in common within multiple profiles.

```
(host) [mynode] (config) #ap mesh-cluster-profile <profile-name> clone
    <source-profile-name>
```

## Viewing Mesh Cluster Profile Settings

To view a complete list of mesh cluster profiles and their status:

```
(host) [mynode] (config) #show ap mesh-cluster-profile
```

To view the settings of a specific mesh cluster profile:

```
(host) [mynode] (config) #show ap mesh-cluster-profile <profile-name>
```

## Associating Mesh Cluster Profiles

The following commands associate a mesh cluster profile to an AP group or an individual AP. For deployments with multiple mesh clusters, you must also configure the profile's priority. Remember, the lower the priority number, the higher the priority. The mesh cluster priority determines the order by which the mesh cluster profiles are used. This allows you, rather than the link metric algorithm, to control the network topology by defining the cluster profiles to use if one becomes unavailable.

To associate a mesh cluster profile to an AP group in a single-cluster deployment:

```
(host) [mynode] (config) #ap-group <group> mesh-cluster-profile <profile-
    name>
```

To associate a mesh cluster profile to an individual AP in a single-cluster deployment:

```
(host) [mynode] (config) #ap-name <name> mesh-cluster-profile <profile-name>
```

To associate a mesh cluster profile to an AP group in a multiple-cluster deployment:

```
(host) [mynode] (config) #ap-group <group> mesh-cluster-profile <profile-
    name> priority <priority>
```

To associate a mesh cluster profile to an individual AP in a multiple-cluster deployment, use the command

```
(host) [mynode] (config) #ap-name <name>
    mesh-cluster-profile <profile-name> priority <priority>
```

Example:

```
(host) [mynode] (config) #ap-group group1
    mesh-cluster-profile cluster1 priority 5
    mesh-cluster-profile cluster2 priority 10
(host) [mynode] (config) #ap-group2
    mesh-cluster-profile cluster1 priority 10
    mesh-cluster-profile cluster2 priority 5
    mesh-radio-profile channel2
```

## Excluding a Mesh Cluster Profile from a Mesh Node

To exclude a specific mesh cluster profile from an AP:

```
(host) [mynode] (config) #ap-name <name> exclude-mesh-cluster-profile-ap
    <profile-name>
```

## Deleting a Mesh Cluster Profile

If no APs are using a mesh cluster profile, you can delete that profile using the **no** parameter:

```
(host) [mynode] (config) #no ap mesh-cluster-profile <profile-name>
```

## Creating and Editing Mesh Radio Profiles

The mesh radio profile determines many of the settings used by mesh nodes to establish mesh links and the path to the mesh portal, including the maximum number of children a mesh node can accept, and transmit rates for the 802.11a and 802.11g radios. The attributes of the mesh radio profile are applied to a mesh point upon receiving its configuration from the managed node. You can configure multiple radio profiles; however, you select and deploy only *one* radio profile per AP group. Radio profiles, including the “default” profile, are not active until you provision your APs for mesh.

If you modify a currently provisioned and running radio profile, your changes take effect immediately. You do not need to reboot the managed device or the AP to apply the changes.

### Managing Mesh Radio Profiles in the WebUI

Use the following procedures to define and manage mesh radio profiles using the WebUI.

#### Creating or Editing a Mesh Radio Profile

To create or edit an existing mesh radio profile, refer to the following steps.

1. In the **Mobility Master** node hierarchy, navigate to **Configuration > System** and open the **Profiles** window.
2. Expand the **Mesh** tab in the **All Profiles** pane, then open the **Mesh Radio profile**.
3. The procedure to create a new mesh profile varies slightly from the procedure to edit an existing profile.
  - To create a new mesh profile: select **Add Profile**. Enter a new mesh radio profile name in the field to the right of the drop-down list.
  - To edit an existing mesh profile: select the profile that you want to edit from the **All Profiles** pane.
4. Configure your desired mesh radio settings.

Mesh Radio profile configuration settings are divided into two tabs, **General** and **Advanced**. The **General** tab displays only those configuration settings that often need to be adjusted to suit a specific network. The **Advanced** tab shows all configuration settings, including settings that do not need frequent adjustment or should be kept at their default values. If you change a setting on one tab, then click and display the other tab without saving your configuration, that setting reverts to its previous value. The basic and advanced profile settings are described in [Table 119](#).

**Table 119:** Mesh Radio Profile Configuration Parameters

Parameter	Description
<b>Basic Mesh Radio Settings</b>	
Link Threshold	<p>Use this setting to optimize operation of the link metric algorithm.</p> <p>Indicates the minimal RSSI value. If the RSSI value is below this threshold, the link may be considered a sub-threshold link. A sub-threshold link is one whose average RSSI value falls below the configured link threshold.</p> <p>If this occurs, the mesh node may try to find a better link on the same channel and cluster (only neighbors on the same channel are considered).</p> <p>Default: 12. The supported threshold is hardware dependent, with a practical range of 10–90.</p>
<b>Advanced Mesh Radio Settings</b>	

Parameter	Description
802.11a Transmit Rates	<p>Indicates the transmit rates for the 802.11a radio.</p> <p>The AP attempts to use the highest transmission rate to establish a mesh link. If a rate is unavailable, the AP goes through the list and uses the next highest rate.</p> <p>To modify transmit rates, do one of the following:</p> <ul style="list-style-type: none"> <li>• In the WebUI, deselect (uncheck) a specific rate box to use fewer rates when establishing a mesh link.</li> <li>• In the CLI, enter the specific rates to use.</li> </ul> <p>Default: All transmission rates are selected and used. If you do not select 802.11a or 802.11g transmit rates, all rates are selected by default when you click <b>Save</b>.</p>
802.11g Transmit Rates	<p>Indicates the transmit rates for the 802.11g radio.</p> <p>The AP attempts to use the highest transmission rate to establish a mesh link. If a rate is unavailable, the AP goes through the list and uses the next highest rate.</p> <p>To modify transmit rates, do one of the following:</p> <ul style="list-style-type: none"> <li>• In the WebUI, deselect (uncheck) a specific rate box to use fewer rates when establishing a mesh link.</li> <li>• In the CLI, enter the specific rates to use.</li> </ul> <p>Default: All transmission rates are selected and used. If you do not select 802.11a or 802.11g transmit rates, all rates are selected by default when you click <b>Save</b>.</p>
Allowed VLANs on Mesh Link	<p>List the VLAN ID numbers of VLANs allowed on the mesh link.</p>
BC/MC Rate Optimization	<p>Broadcast/Multicast Rate Optimization dynamically selects the rate for sending broadcast/multicast frames on any BSS. This feature determines the optimal rate for sending broadcast and multicast frames based on the lowest of the unicast rates across all associated clients.</p> <p>When you enable the Multicast Rate Optimization feature, the managed node scans the list of all associated stations in that BSS and finds the lowest transmission rate as indicated by the rate adaptation state for each station. If there are no associated stations in the BSS, it selects the lowest configured rate as the transmission rate for broadcast and multicast frames.</p> <p>This feature is enabled by default. Multicast Rate Optimization applies to broadcast and multicast frames only. 802.11 management frames are not affected by this feature and are transmitted at the lowest configured rate. When enabled, this setting dynamically adjusts the multicast rate to that of the slowest connected mesh child. Multicast frames are not sent if there are no mesh children.</p> <p><b>NOTE:</b> This feature should only be enabled on a BSS where all associated stations are sending or receiving unicast data. If there is no unicast data to or from a particular station, then the rate adaptation state may not accurately reflect the current sustainable transmission rate for that station. This could result in a higher packet error rate for broadcast/multicast packets at that station. Configuring the <b>Video Multicast Rate Optimization</b> parameter overrides the configuration of <b>BC/MC Rate Optimization</b> parameter for VI-tagged multicast traffic. Multicast traffic that is not VI-tagged behaves the same with BC/MC as before. If multicast rate is not set, all traffic behaves the same.</p> <p>Default: Enabled.</p>

Parameter	Description
Heartbeat threshold	<p>Indicates the maximum number of heartbeat messages that can be lost between neighboring mesh nodes.</p> <p>Default: 10 missed heartbeats.</p> <p>Range: 1–255.</p>
Maximum Children	<p>Indicates the maximum number of children a mesh node can accept.</p> <p>Default: 64 children.</p> <p>Range: 1–64</p>
Maximum Hop Count	<p>Indicates the maximum hop count from the mesh portal.</p> <p>Default: 8 hops.</p> <p>Range: 1–32</p>
Mesh Private VLAN	<p>A VLAN ID for control traffic between an remote mesh portal and mesh nodes. This VLAN ID must not be used for user traffic.</p> <p>Range: 0–4094. Default: 0 (disabled).</p> <p>For further information on configuring a remote mesh portal, see <a href="#">Configuring Remote Mesh Portals (RMPs) on page 588</a></p>
Metric algorithm	<p>This parameter specifies the algorithm used by a mesh node to select its parent. Use this setting to optimize operation of the link metric algorithm.</p> <p>Available options are:</p> <ul style="list-style-type: none"> <li>• best-link-rssi: Selects the parent with the strongest RSSI, regardless of the number of children a potential parent has.</li> <li>• distributed-tree-rssi: selects the parent based on link-RSSI and node cost based on the number of children. This option evenly distributes the mesh points over high quality uplinks. Low quality uplinks are selected as a last resort.</li> </ul> <p>Default: distributed-tree-rssi. It is recommended to use the default value.</p>
Rate Optimization for delivering EAPOL frames and mesh echoes	<p>When you enable this parameter, EAPOL frames, mesh echo requests and echo responses are sent at a lower rate.</p>

Parameter	Description
Reselection mode	<p>Use this setting to optimize operation of the link metric algorithm.</p> <p>Available options are:</p> <ul style="list-style-type: none"> <li>• reselect-anytime</li> <li>• reselect-never</li> <li>• startup-subthreshold</li> <li>• subthreshold-only</li> </ul> <p>For complete information on reselection mode options, see <a href="#">Mesh Radio Profiles on page 558</a></p>
Retry Limit	<p>Indicates the number of times a mesh node can re-send a packet.</p> <p>Default: 4 times.</p> <p>Range: 1–15</p>
RTS Threshold	<p>Defines the packet size sent by mesh nodes. Mesh nodes transmitting frames larger than this threshold must issue request to send (RTS) and wait for other mesh nodes to respond with clear to send (CTS) to begin transmission. This helps prevent mid-air collisions.</p> <p>Default: 2,333 bytes.</p> <p>Range: 256– 2,346.</p>

5. Click **Submit**.
6. Click **Pending Changes**.
7. In the **Pending Changes** window, select the check box and click **Deploy Changes**.

The profile name appears in the Mesh Radio Profile list with your configured settings. If you configure this for the AP group, this profile also becomes the selected radio profile used by the mesh portal for your mesh network.

### Assigning a Mesh Radio Profile to a Mesh AP or AP Group

To associate a mesh radio profile to a mesh AP or AP group, refer to the following steps.

1. In the **Managed Network** node hierarchy, navigate to **Configuration > Access Points** or **Configuration > AP Groups**.
2. Select an AP or AP group.
3. Click the **Profiles** tab.
4. Under the **Profiles** list, expand **Mesh**, and then select a **Mesh Radio** profile.
5. Open the **Mesh High-throughput SSID** configuration for the radio profile and select an SSID profile from the **Mesh High-throughput SSID profile** drop-down list.
6. Click **Submit**.
7. Click **Pending Changes**.
8. In the **Pending Changes** window, select the check box and click **Deploy Changes**.

The profile name appears in the Mesh Radio Profile list with your configured settings. If you configure this for the AP group, this profile also becomes the selected radio profile used by the mesh portal for your mesh network.

Click the **Delete** button by the name of the profile you want to delete.

## Managing Mesh Radio Profiles in the CLI

You must be in config mode to create, modify, or delete a mesh radio profile using the CLI. Specify an existing mesh profile with the <profile-name> parameter to modify an existing profile, or enter a new name to create an entirely new profile.

### Creating or Modifying a Mesh Radio Profile

Configuration details and any default values for each of these parameters are described in [Table 119](#). If you do not specify a parameter for a new profile, that profile uses the default value for that parameter. Put the **no** option before any parameter to remove the current value for that parameter and return it to its default setting. Enter **exit** to leave the mesh radio profile mode.

```
(host) [mynode] (config) #ap mesh-radio-profile <profile-name>
  a-tx-rates
  allowed-vlans
  children <children>
  clone <source-profile-name>
  eapol-rate-opt
  g-tx-rates [1|2|5|6|9|11|12|18|24|36|48|54]
  heartbeat-threshold <count>
  hop-count <hop-count>
  link-threshold <count>
  max-retries <max-retries>
  mesh-ht-ssid-profile
  mesh-mcast-opt
  mesh-survivability
  metric-algorithm {best-link-rssi|distributed-tree-rssi}
  mpv <vlan-id>
  no
  reselection-mode
  rts-threshold <rts-threshold>
```

You can also create a new mesh radio profile by copying the settings of an existing profile using the clone parameter. Using the clone command to create a new profile makes it easier to keep constant attributes in common within multiple profiles.

```
(host) [mynode] (config) #ap mesh-radio-profile <profile-name> clone <source-profile-name>
```

### Assigning a Mesh Radio Profile to a Mesh AP or AP Group

To associate a mesh radio profile with an AP or AP group, use the following commands. When you add the mesh cluster profile to the AP group, you must also define the cluster priority.

```
(host) [mynode] (config) #ap-group <group>
  mesh-radio-profile <profile-name> priority <priority>
```

To associate a mesh radio profile with an individual AP:

```
(host) [mynode] (config) #ap-name <name>
  mesh-radio-profile <profile-name> priority <priority>
```

The following examples assign the mesh cluster profiles **cluster1** and **cluster2** to two different AP groups. In the AP group **group1**, **cluster1** has a priority of 5, and **cluster2** has a priority of 10, so **cluster1** has the higher priority. In the AP group **group2**, **cluster1** has a priority of 10, and **cluster2** has a priority of 5, so **cluster2** has the higher priority.

```
(host) [mynode] (config) #ap-group group1
  mesh-cluster-profile cluster1 priority 5
  mesh-cluster-profile cluster2 priority 10
```

```
(host) [mynode] (config) #ap-group group2
  mesh-cluster-profile cluster1 priority 10
  mesh-cluster-profile cluster2 priority 5
```

## Deleting Mesh Radio Profiles

You can delete a mesh radio profile only if no other APs or AP groups use that profile.

To delete a mesh radio profile using the WebUI:

1. In the **Mobility Master** node hierarchy, navigate to **Configuration > System** and open the **Profiles** window.
2. Expand the **Mesh** tab in the **All Profiles** pane, then open the **Mesh Radio profile**.
3. Select the mesh radio profile from the list
4. Click **Delete** icon by the name of the profile you want to delete.

The following CLI command deletes a radio profile via the command-line interface.

```
(host) [mynode] (config) #no ap mesh-radio-profile <profile-name>
```

## Creating and Editing Mesh High-Throughput SSID Profiles

The mesh high-throughput SSID profile defines settings unique to 802.11n and 802.11ac-capable, high-throughput APs. If none of the APs in your mesh deployment are 802.11n or 802.11ac-capable APs, you do not need to configure a high-throughput SSID profile. If you modify a currently provisioned and running high-throughput SSID profile, your changes take effect immediately. You do not need to reboot the managed device or the AP.

### Managing Mesh High-Throughput SSID Profiles in the WebUI

Use the following procedures to manage your high-throughput SSID profiles using the WebUI.

#### Creating a Profile

To create a high-throughput SSID profile:

1. In the **Mobility Master** node hierarchy, navigate to **Configuration > System** and open the **Profiles** window.
2. Expand the **Mesh** tab in the **All Profiles** menu, and select the **Mesh High-throughput SSID** profile.
3. Select **Add Mesh High-throughput SSID profile**.
4. Enter a name for the new profile.
5. Configure the mesh high-throughput SSID parameters described in [Table 120](#). The Mesh High-Throughput SSID Profile configuration settings are divided into two tabs, **General** and **Advanced**. The **General** tab displays only those configuration settings that often need to be adjusted to suit a specific network. The **Advanced** tab shows all configuration settings, including settings that do not need frequent adjustment or should be kept at their default values. If you change a setting on one tab then click and display the other tab without saving your configuration, that setting reverts to its previous value.
6. Click **Submit**.
7. Click **Pending Changes**.
8. In the **Pending Changes** window, select the check box and click **Deploy Changes**.

The profile name appears in the Mesh High-throughput SSID Profile list with your configured settings.



**Table 120: Mesh High-Throughput SSID Profile Configuration Parameters**

Parameter	Description
40 MHz channel usage	Enable or disable the use of 40 MHz channels. Default: enabled
80 MHz channel usage	Enable or disable the use of 80 MHz channels. Default: enabled
High-throughput Enable (SSID)	Enable or disable high-throughput (802.11n) features on the SSID. Default: enabled
VHT- Explicit Transmit Beamforming	Enable/Disable use of Very High Through-put Explicit Transmit Beamforming.  If this parameter is disabled, the other transmit beamforming configuration settings have no effect.
Very High throughput enable (VHT)	Enable or disable very high-throughput (802.11av) features on the SSID. Default: enabled
Temporal Diversity Enable	When a client is not responding to 802.11 packets, the AP will launch two hardware retries. If you enable this option and hardware retries are not successful, then the AP will launch and the software retries.
BA AMSDU Enable	Enable/Disable Receive AMSDU in BA negotiation.
Legacy stations	Allow or disallow associations from legacy (non-HT) stations. By default, this parameter is enabled (legacy stations are allowed).
Low-density Parity Check	If enabled, the AP advertises Low-density Parity Check (LDPC) support LDPC improves data transmission over radio channels with high levels of background noise. (For 130 Series only)
Maximum number of spatial streams usable for STBC reception	Controls the maximum number of spatial streams usable for STBC reception. 0 disables STBC reception, 1 uses STBC for MCS 0-7. Higher MCS values are not supported. (Supported on the Series, 130 Series, AP-175 and AP-105 only. The configured value adjusts based on AP capabilities.)  If transmit beamforming is enabled, STBC is disabled for disabled for beamformed frames.
Maximum number of spatial streams usable for STBC transmission.	Controls the maximum number of spatial streams usable for STBC transmission. 0 disables STBC transmission, 1 uses STBC for MCS 0-7. Higher MCS values are not supported. (Supported on Series, AP-175, 130 Series and AP-105 only. The configured value adjusts based on AP capabilities.)  If you enable transmit beamforming, STBC is disabled for disabled for beamformed frames.
MPDU Aggregation	Enable or disable MAC protocol data unit (MPDU) aggregation.

Parameter	Description
	High-throughput APs are able to send aggregated MAC protocol data units (MPDUs), which allow an AP to receive a single block acknowledgment instead of multiple ACK signals. This option, which is enabled by default, reduces network traffic overhead by effectively eliminating the need to initiate a new transfer for every MPDU.
Max received A-MPDU size	Maximum size of a received aggregate MPDU, in bytes. Allowed values: 8191, 16383, 32767, 65535.
Max transmitted A-MPDU size	Maximum size of a transmitted aggregate MPDU, in bytes. Range: 1576–65535
Maximum number of MSDUs in an A-MSDU on best-effort AC	Maximum number of MSDUs in a TX A-MSDU on best-effort AC. TX-AMSDU disabled if 0. Range: 0-15 Default: 2
Maximum number of MSDUs in an A-MSDU on background AC	Maximum number of MSDUs in a TX A-MSDU on background. TX-AMSDU disabled if 0. Range: 0-15 Default: 2
Maximum number of MSDUs in an A-MSDU on video AC	Maximum number of MSDUs in a TX A-MSDU on video AC. TX-AMSDU disabled if 0. Range: 0-15 Default: 2
Maximum number of MSDUs in an A-MSDU on voice AC	Maximum number of MSDUs in a TX A-MSDU on voice AC. TX-AMSDU disabled if 0. Range: 0-15 Default: 0
Maximum VHT MPDU size	Maximum size of a VHT MPDU, in bytes. Range: 3895, 7991, 11454
Min MPDU start spacing	Minimum time between the start of adjacent MPDUs within an aggregate MPDU, in microseconds. Allowed values: 0 (No restriction on MPDU start spacing), .25 µsec, .5 µsec, 1 µsec, 2 µsec, 4 µsec.
Short guard interval in 20 MHz mode	Enable or disable use of short (400ns) guard interval in 20 MHz mode. This parameter is enabled by default.

Parameter	Description
	<p>A guard interval is a period of time between transmissions that allows reflections from the previous data transmission to settle before an AP transmits data again. An AP identifies any signal content received inside this interval as unwanted inter-symbol interference, and rejects that data. The 802.11n standard specifies two guard intervals: 400ns (short) and 800ns (long). Enabling a short guard interval can decrease network overhead by reducing unnecessary idle time on each AP. Some outdoor deployments, may, however require a longer guard interval. If the short guard interval does not allow enough time for reflections to settle in your mesh deployment, inter-symbol interference values may increase and degrade throughput.</p>
<p>Short guard interval in 40 MHz mode</p>	<p>Enable or disable use of short (400ns) guard interval in 40 MHz mode. This parameter is enabled by default.</p> <p>A guard interval is a period of time between transmissions that allows reflections from the previous data transmission to settle before an AP transmits data again. An AP identifies any signal content received inside this interval as unwanted inter-symbol interference, and rejects that data. The 802.11n standard specifies two guard intervals: 400ns (short) and 800ns (long). Enabling a short guard interval can decrease network overhead by reducing unnecessary idle time on each AP. Some outdoor deployments, may, however require a longer guard interval. If the short guard interval does not allow enough time for reflections to settle in your mesh deployment, inter-symbol interference values may increase and degrade throughput.</p>
<p>Short guard interval in 80 MHz mode</p>	<p>Enable or disable use of short (400ns) guard interval in 80 MHz mode.</p> <p>A guard interval is a period of time between transmissions that allows reflections from the previous data transmission to settle before an AP transmits data again. An AP identifies any signal content received inside this interval as unwanted inter-symbol interference, and rejects that data.</p> <p>The 802.11n standard specifies two guard intervals: 400ns (short) and 800ns (long). Enabling a short guard interval can decrease network overhead by reducing unnecessary idle time on each AP. Some outdoor deployments, may, however require a longer guard interval. If the short guard interval does not allow enough time for reflections to settle in your mesh deployment, inter-symbol interference values may increase and degrade throughput.</p> <p>This parameter is enabled by default.</p>

Parameter	Description
Supported MCS set	<p>A list of Modulation Coding Scheme (MCS) values or ranges of values to be supported on this SSID. The MCS you choose determines the channel width (20MHz vs. 40MHz) and the number of spatial streams used by the mesh node.</p> <p>The default value is 1-23; the complete set of supported values. To specify a smaller range of values, enter a hyphen between the lower and upper values. To specify a series of different values, separate each value with a comma.</p> <p>Examples:</p> <p>2-10</p> <p>1,3,6,9,12</p> <p>Range: 0-23.</p>
VHT - Support MCS Map	<p>A list of Modulation Coding Scheme (MCS) values or ranges of values to be supported on this SSID. The MCS you choose determines the channel width (20MHz vs. 40MHz vs 80MHz) and the number of spatial streams used by the mesh node.</p> <p>The default value is 1-23; the complete set of supported values. To specify a smaller range of values, enter a hyphen between the lower and upper values. To specify a series of different values, separate each value with a comma.</p> <p>Examples:</p> <p>2-10</p> <p>1,3,6,9,12</p> <p>Range: 0-23.</p>
vht-txbf-explicit-enable	Enable/Disable use of VHT Explicit Transmit Beamforming.

### Assigning a Profile to an AP Group

1. In the **Managed Network** node hierarchy, navigate to **Configuration > Access Point** or **Configuration > AP Groups**.
2. Select an AP or AP group.
3. Click the **Profiles** tab.
4. Under the **Profiles** list, expand **Mesh**, and then select a **Mesh High-throughput SSID** profile.
5. In the **Profile Details** window pane, select a profile from the **Mesh High-throughput SSID profile** drop-down list.
6. Click **Submit**.
7. Click **Pending Changes**.
8. In the **Pending Changes** window, select the check box and click **Deploy Changes**.

The profile name appears in the Mesh High-throughput SSID Profile list with your configured settings. If you configure this for the AP group, this profile also becomes the selected high-throughput SSID profile used by the mesh portal for your mesh network.

### Editing a Profile

1. In the **Mobility Master** node hierarchy, navigate to **Configuration > System** and open the **Profiles** window.

2. Expand the **Mesh** tab in the **All Profiles** menu, and then select **Mesh High-throughput SSID**.
3. Select the Mesh high-throughput profile you want to edit.
4. Change the settings as desired. [Table 120](#) describes the parameters you can configure in this profile.
5. Click **Submit**.
6. Click **Pending Changes**.
7. In the **Pending Changes** window, select the check box and click **Deploy Changes**.

## Deleting a Profile

You can delete a mesh high-throughput SSID profile only if no APs or AP groups are associated with that profile.

1. In the **Mobility Master** node hierarchy, navigate to **Configuration > System** and open the **Profiles** window.
2. Expand the **Mesh** tab in the **All Profiles** menu, and then select **Mesh High-throughput SSID**.
3. Select the Mesh High-throughput SSID profile you want to delete, and then click the **delete** icon.

## Managing Mesh High-Throughput SSID Profiles in the CLI

You must be in config mode to create, modify or delete a mesh high-throughput SSID radio profile using the CLI. Specify an existing high-throughput SSID profile with the <profile-name> parameter to modify an existing profile, or enter a new name to create an entirely new profile.

### Creating or Modifying a Profile

Configuration details and any default values for each of these parameters are described in [Table 120](#). If you do not specify a parameter for a new profile, that profile uses the default value for that parameter. Put the **no** option before any parameter to remove the current value for that parameter and return it to its default setting. Enter **exit** to leave the high-throughput radio profile mode

```
(host) [mynode] (config) #ap mesh-ht-ssid-profile <profile-name>
  40mhz-enable
  80mhz-enable
  ba-amsdu-enable
  clone
  high-throughput-enable
  ldpc
  legacy-stations
  max-rx-a-mpdu-size
  max-tx-a-mpdu-size
  max-tx-a-msdu-count-be
  max-tx-a-msdu-count-bk
  max-tx-a-msdu-count-vi
  max-tx-a-msdu-count-vo
  max-vht-mpdu-size
  min-mpdu-start-spacing
  mpdu-agg
  no
  short-guard-intvl-20mhz
  short-guard-intvl-40mhz
  short-guard-intvl-80mhz
  stbc-rx-streams
  stbc-tx-streams
  supported-mcs-set
  temporal-diversity

  vht-supported-mcs-map
```

You can also create a new mesh high-throughput SSID profile by copying the settings of an existing profile using the `clone` parameter. Using the `clone` command to create a new profile makes it easier to keep constant attributes in common within multiple profiles.

```
(host) [mynode] (config) #ap mesh-ht-ssid-profile <profile-name> clone <source-profile-name>
```

### Assigning a Profile to an AP or AP Group

To associate a mesh high-throughput SSID profile with an AP group:

```
(host) [mynode] (config) #ap-group <group> mesh-ht-ssid-profile <profile-name>
```

To associate a mesh radio profile with an individual AP:

```
(host) [mynode] (config) #ap-name <name> mesh-ht-ssid-profile <profile-name>
```

### Viewing High-throughput SSID Settings

To view a complete list of high-throughput profiles and their status:

```
(host) [mynode] (config) #show ap mesh-ht-ssid-profile
```

To view the settings of a specific high-throughput profile:

```
(host) [mynode] (config) #show ap mesh-ht-ssid-profile <profile-name>
```

### Deleting a Profile

If no AP or AP group is using a mesh high-throughput SSID profile, you can delete that profile using the `no` parameter:

```
(host) [mynode] (config) #no ap mesh-ht-ssid-profile <profile-name>
```

## Configuring Ethernet Ports for Mesh

If you use mesh to join multiple Ethernet LANs, configure and enable bridging on the mesh point Ethernet port. This section describes how to configure Ethernet ports for bridging or secure jack operation using the wired AP profile. The wired AP profile controls the configuration of the Ethernet port(s) on your AP.



---

Mesh nodes only support bridge mode and tunnel mode on their wired ports (Enet0 or Enet1). Split tunnel mode is not supported. Use bridge mode to configure bridging on the mesh point Ethernet port. Use tunnel mode to configure secure jack operation on the mesh node Ethernet port.

---

When configuring the Ethernet ports on dual-port APs, note the following requirements for the AP configured as a mesh portal:

- Connect Enet0 to the managed device to obtain an IP address. The wired AP profile controls Enet1.
- Only Enet1 supports secure jack operation.

### Configuring Bridging on the Ethernet Port

Use the following procedure to configure bridging on the Ethernet port via the WebUI.

1. In the **Mobility Master** node hierarchy, navigate to **Configuration > System** and open the **Profiles** window.
2. Expand the **AP** tab in the **All Profiles** menu.
3. Open **Wired AP** and select a profile.
4. Under **General** settings, do the following:
  - a. Select the **Wired AP enable** check box. This option is not selected by default.
  - b. From the **Forward mode** drop-down list, select **bridge**.

- c. Optionally, from the **Switchport mode** drop-down list, select **access or trunk**. These options only apply to bridge mode configurations.
    - Access mode forwards untagged packets received on the port to the managed device and they appear on the configured access mode VLAN. Tagged packets are dropped. All packets received from the managed device and sent via this port are untagged. Define the access mode VLAN in the **Access mode VLAN** field.
    - Trunk mode contains a list of allowed VLANs. Any packet received on the port that is tagged with an allowed VLAN is forwarded to the managed device. Untagged packets are forwarded to the managed device on the configured Native VLAN. Packets received from the managed device and sent out the port remain tagged unless the tag value in the packet is the Native VLAN, in which case the tag is removed. Define the Native VLAN in the **Trunk mode native VLAN** field and the other allowed VLANs in the **Trunk mode allowed VLANs** field.
  - d. Optionally, select **Trusted** to configure this as a trusted port.
5. Click **Submit**.
  6. Click **Pending Changes**.
  7. In the **Pending Changes** window, select the check box and click **Deploy Changes**.

Use the following commands to configure Ethernet port bridging via the CLI.

```
(host) [mynode] (config) #ap wired-ap-profile <profile>
broadcast
clone
forward-mode {bridge | split-tunnel | tunnel}
wired-ap-enable
```

Optionally, you can configure the following wired AP profile settings:

```
(host) [mynode] (config) #ap wired-ap-profile <profile>
switchport mode {access | mode | trunk}
switchport access vlan <vlan>
switchport trunk native vlan <vlan>
switchport trunk allowed vlan <vlan>
trusted
```

## Configuring Ethernet Ports for Secure Jack Operation

You can configure the Ethernet port(s) on mesh nodes to operate in tunnel mode. Known as secure jack operation for mesh, this configuration allows Ethernet frames coming into the specified wired interface to be generic routing encapsulation (GRE) tunneled to the managed device. Likewise, Ethernet frames coming from the tunnel are bridged to the corresponding wired interface. This allows an Ethernet port on the mesh node to appear as an Ethernet port on the managed devices separated by one or more Layer-3 domains. You can also enable VLAN tagging.

Unlike secure jack on non-mesh APs, any mesh node configured for secure jack uses the mesh link, rather than Enet0, to tunnel the frame to the managed device.

When configuring mesh Ethernet ports for secure jack operation, note the following guidelines:

- Mesh points support secure jack on Enet0 and Enet1.
- Mesh portals only support secure jack on Enet1. This function is only applicable to Aruba APs that support a second Ethernet port and mesh, such as the 130 Series.

You configure secure jack operation in the wired AP profile.




---

The parameters in the wired AP profile only apply to the wired AP interface to which they are assigned. Two wired interfaces can have different parameter values.

---

## In the WebUI

Use the following procedure to configure secure jack operation using the WebUI.

1. In the **Mobility Master** node hierarchy, navigate to **Configuration > System** and open the **Profiles** window.
2. Expand the **AP** tab in the **All Profiles** menu.
3. Open **Wired AP** and select a profile. The settings for the currently selected wired AP profile appear.
4. Under **General** settings, do the following:
  - a. Select the **Wired AP enable** check box. This option is not selected by default.
  - b. From the **Forward mode** drop-down list, select **tunnel**.
  - c. Optionally, select **Trusted** to configure this as a trusted port.
5. Click **Submit**.
6. Click **Pending Changes**.
7. In the **Pending Changes** window, select the check box and click **Deploy Changes**.

## In the CLI

To configure secure jack operation using the command-line interface, access the CLI in config mode and issue the following commands:

```
(host) [mynode] (config) #ap wired-ap-profile <profile>
    forward-mode tunnel
    wired-ap-enable
```

Optionally, you can configure the following wired AP profile settings:

```
(host) [mynode] (config) #ap wired-ap-profile <profile>
    trusted
```

## Extending the Life of a Mesh Network

To prevent your mesh network from going down in the event of a managed device failure, modify the following settings in the AP system profile(s) used by mesh nodes to maintain the mesh network until the managed device is available:



---

It is recommended to use the default maximum request retries and bootstrap threshold settings for most mesh networks; however, if you must keep your mesh network alive, you can modify the settings as described in this section. The modified settings are not applicable if mesh portals are directly connected to the managed device.

---

- **Maximum request retries:** maximum number of times to retry AP-generated requests. The default is 10 times. If you must modify this setting, it is recommended to set a value of 10,000.
- **Bootstrap threshold:** number of consecutive missed heartbeats before the AP reboots. (Heartbeats are sent once per second.) The default is 9 missed heartbeats. If you must modify this setting, it is recommended to set a value of 5,000.

When the managed device comes back online, the affected mesh nodes (mesh portals and mesh points) rebootstrap; however, the mesh link is not affected and continues to be up.

## In the WebUI

Use the following procedure to modify the AP system profile via the WebUI.

1. In the **Mobility Master** node hierarchy, navigate to **Configuration > System** and open the **Profiles** window.
2. Expand the **AP** tab in the **All Profiles** menu.
3. Open **AP System profile** and select the AP system profile you want to edit



4. Open the **Advanced** settings in the AP system profile window and make the following changes:
  - a. Change the **Maximum Request Retries** to 10000.
  - b. Change the **Bootstrap threshold** to 5000.
5. Click **Submit**.
6. Click **Pending Changes**.
7. In the **Pending Changes** window, select the check box and click **Deploy Changes**.

### In the CLI

To modify the AP system profile via the command-line interface, access the CLI in config mode and issue the following commands:

```
(host) [mynode] (config) #ap system-profile <profile>
    max-request-retries 10000
    bootstrap-threshold 5000
```

## Provisioning Mesh Nodes

Provisioning mesh nodes is similar to thin APs; however, there are some key differences. Thin APs establish a channel to the managed device from which they receive the configuration for each radio interface. Mesh nodes, in contrast, get their radio interfaces up and running before making contact with the managed device. This requires a minimum set of parameters from the AP group and mesh cluster that enables the mesh node to discover a neighbor to create a mesh link and subsequent channel with the managed device. To do this, you must first configure mesh cluster profiles for each mesh node prior to deployment. See [Creating and Editing Mesh Radio Profiles](#) for more information.

On each radio interface, you provision a mode of operation: mesh node or thin AP (access) mode. If you do not specify mesh, the AP operates in thin AP (access) mode. If you configure mesh, the AP is provisioned with a minimum of two mesh cluster profiles: the “default” mesh cluster profile and an emergency read-only recovery profile, as described in the section [Configuring Mesh Cluster Profiles](#). If you create and select multiple mesh cluster profiles, the AP is provisioned with those as well. If you have a dual-radio AP and configure one radio for mesh and the other as a thin AP, each radio is provisioned as configured.

Each radio provisioned in mesh mode can operate in one of two roles: mesh portal or mesh point. You explicitly configure the role, as described in this section. This allows the AP to know whether it uses the mesh link (via the mesh point/mesh portal) or an Ethernet link to establish a connection to the managed device.

During the provisioning process, mesh nodes look for a mesh profile that the AP group and AP name is a member of and stores that information in flash. If you have multiple cluster profiles, the mesh portal uses the best profile to bring-up the mesh network. Mesh points in contrast go through the list of mesh cluster profiles in order of priority to decide which profile to use to associate themselves with the network. In addition, when a mesh point is provisioned, the country code is sent to the AP from its AP name or AP group along with the mesh cluster profiles. Mesh nodes also learn the recovery profile, which is automatically generated by the Mobility Master. If the other mesh cluster profiles are unavailable, mesh nodes use the recovery profile to establish a link to the Mobility Master; data forwarding does not take place.



---

If you create a new mesh cluster profile for an existing deployment, you must re-provision the AP for the new profile to take effect. If you re-provision mesh nodes that are already operating, re-provision the most distant (highest hop count) mesh points first followed by the mesh portals. If you re-provision the mesh portal first, the mesh points may be unable to form a mesh link. Re-provisioning the AP causes it to automatically reboot. This may cause a disruption of service to the network.

---

## Provisioning Caveats

Remember the following when provisioning APs for mesh:

- You must provision the AP before you install it as a mesh node in a mesh deployment. To provision the AP, it must be physically connected to the local network or directly connected to the Mobility Master. When connected and powered on, the AP must also be able to obtain an IP address from a DHCP server on the managed device or from the Mobility Master.
- Make sure that the provisioned mesh nodes form a connected mesh network before physically deploying the APs. For more information, see [Verifying Your Mesh Network](#).
- In multi-node networks, save your mesh cluster configuration before provisioning the mesh nodes. To save your configuration in the WebUI, at the top of any window, click **Pending Changes > Deploy changes**. To save your configuration in the CLI, use the command **write memory**.

## Provisioning Mesh Nodes

Reprovisioning the AP causes it to automatically reboot. The following procedures describe the process to provision a mesh portal or mesh node via the WebUI or CLI. (The easiest way to provision a mesh node is to use the Provisioning window in the WebUI.) To provision a remote mesh portal, see [Configuring Remote Mesh Portals \(RMPs\)](#).

## Verifying Your Mesh Network

To view a list of your mesh APs via the WebUI, navigate to the one of the following pages in the **Managed Network** node hierarchy:

- **Dashboard > Network**
- **Dashboard > Controllers**

To view mesh APs and the mesh topology tree using the command line interface, issue the following commands:

```
(host) [mynode] #show ap mesh active

(host) [mynode] #show ap mesh topology
```

## Verification Checklist

After provisioning the mesh APs, follow the steps below to ensure that the mesh network is up and operating correctly.

- Issue the command **show ap mesh topology** to verify all the mesh APs are up and the topology is as expected. (Wait 10 minutes after startup for the topology to stabilize.)
- Verify each mesh node has the expected RSSI to its neighboring mesh nodes. The mesh topology is updated periodically, so access the command-line interface and issue the command **show ap mesh neighbors** for the current status. If the RSSI is low, verify that the tx-power settings in the mesh node's 802.11a/802.11g radio profiles are correct, or, if ARM is used, verify the correct minimum tx-power setting.
- Issue the command **show ap mesh debug provisioned-clusters** to verify that the mesh clusters are correctly defined and provisioned (with encryption if desired). Issue the **show running-config | include recovery** command to verify that the cluster's recovery profile matches the managed device's recovery profile.
- Verify antenna provisioning by issuing the **show ap provisioning** command and verify installation parameters for non-default installations (that is, standard indoor APs deployed outside, or outdoor APs deployed inside). Ensure all APs use the same channel list by issuing the **show ap allowed-channels** command.

- If the mesh-radio is to be reserved exclusively for mesh backhaul traffic, issue the command **show ap profile-usage** to identify the radio's 802.11a or 802.11g radio profile, then issue the command **show rf dot11a-radio-profile <profile>** or **show rf dot11g-radio-profile <profile>** to verify the radio is disabled in the profile. Next, use the **show ap bss-table** command to that verify no access Virtual APs are up on the mesh radio.

## CLI Examples

Use the **show ap mesh active** command to verify all nodes are present and that EIRP is correct:

```
(host) [mynode] #show ap mesh active
Mesh Cluster Name: meshprofile1
-----
Name   Group   IP Address      BSSID              Band/Ch/EIRP/MaxEIRP  MTU  Enet 0/1  Mesh Role
-----
mp1    mp1     10.3.148.245    00:1a:1e:85:c0:30  802.11a/157/19/36    Off/Off Point
mp2    mp2     10.3.148.250    00:1a:1e:88:11:f0  802.11a/157/19/36    Bridge/Bridge Point
mp3    mp3     10.3.148.253    00:1a:1e:88:01:f0  802.11a/157/19/36    Bridge/Bridge Point
mpp    mpp125  10.3.148.252    00:1a:1e:88:05:50  802.11a/157/19/36    1578 -/Bridge Portal

Parent #Children  AP Type  Uptime
-----
mp3     0           125     13d:2h:25m:19s
mpp     1           125     14d:21h:23m:49s
mp2     1           125     14d:21h:14m:55s
-       1           125     14d:19h:5m:3s
```

Use the **show ap mesh topology** command to verify the cluster topology, RSSI in presence of network traffic, and Tx and Rx rates.

```
(host) [mynode] #show ap mesh topology

Mesh Cluster Name: sw-ad-GB32
-----
Name Mesh Role   Parent Path Cost  Node Cost  Link Cost  Hop Count  RSSI  Rate Tx/Rx  Last
-----
Update Uplink Age #Children
-----

ad-ap Point (N)   mp3  2      0      0      1      61  300/270  6m:12s
   3h:8m:7s  0

msc-1 Point     mp3  2      0  0      1      64  54/54  6m:36s
2h:48m:12s  0

Total APs :2
(R): Recovery AP. (N): 11N Enabled. For Portals 'Uplink Age' equals uptime.
```

Issue the command **show ap mesh neighbors ap-name <name>** to verify visibility of other mesh nodes is as expected:

```
(host) [mynode] #show ap mesh neighbors ap-name portal

Neighbor list
-----
MAC Portal Channel Age Hops Cost Relation Flags RSSI
Rate Tx/Rx
-----
-----
00:0b:86:e8:09:d1 00:1a:1e:88:01:f0 157 0 1 11.00 C 3h:15m:42s - 65
54/54
00:1a:1e:88:02:91 00:1a:1e:88:01:f0 157 0 1 4.00 C 3h:35m:30s HL 59
300/300
```

00:0b:86:9b:27:78	Yes		157	0	0	12.00	N	3h:22m:46s	-	26	-
00:0b:86:e8:09:d0	00:1a:1e:88:01:f0		157	0	1	11.00	N	3h:15m:36s	-	65	-
00:1a:1e:88:02:90	00:1a:1e:88:01:f0		157+	0	1	2.00	N	3h:35m:6s	HL	59	-

A-Req	A-Resp	A-Fail	HT-Details	Cluster ID
-----	-----	-----	-----	-----
1	1	0	Unsupported	sw-ad-GB32
1	1	0	HT-40MHzsgi-2ss	sw-ad-GB322
0	0	0	Unsupported	mc1
0	0	0	Unsupported	sw-ad-GB32
0	0	0	HT-40MHzsgi-2ss	sw-ad-GB32

Total count: 5, Children: 2

## Configuring Remote Mesh Portals (RMPs)

The following steps describe the procedure to configure a Remote Mesh portal using the WebUI and CLI interfaces.

### Creating a Remote Mesh Portal In the WebUI

A remote mesh portal must be provisioned as both a remote access point and a mesh portal. For instructions on provisioning the remote mesh portal as a remote access point, see [Configuring the Secure Remote Access Point Service on page 640](#).

Wired ports on remote mesh portals can be configured in either bridge or split-tunnel forwarding mode. However, there are limitations to the forwarding modes that can be used by other mesh node types. Do not use bridge or split-tunnel forwarding mode for wired ports on mesh points. Virtual APs on remote mesh portals and remote mesh points also do not support bridge or split-tunnel forwarding mode.




---

A remote mesh portal does not support bridge mode Virtual APs or offline Virtual APs.

---

### Provision the AP

1. In the **Managed Network** node hierarchy, navigate to **Configuration > Access Points**.
2. Open the **Remote APs** tab
3. Select the AP to provision as a remote mesh portal, and then click **Provision**.
4. In the **Authentication** section, select the **Remote AP** option.
5. In the **Remote AP Authentication Method** section of this window, select either **Pre-shared Key** or **Certificate**. If you selected **Pre-Shared Key**, enter and confirm the Internet Key Exchange Pre-Shared Key (IKE PSK).
6. In the **Master Discovery** section, set the Master IP address as the controller IP address.
7. In the **IP settings** section, select **Obtain IP Address Using DHCP**.
8. In the **AP List** section at the bottom of the window, click the **Mesh Role** drop-down list and select **Remote Mesh Portal**.

### Step 2: Define the Mesh Private VLAN in the Mesh Radio Profile

Follow the procedure below to choose a new, non-zero tag value for the mesh private VLAN. Make sure that the mesh private VLAN so that it does not conflict with any local tags assigned in the mesh network. Once

configured, all mesh points come up in that Mesh Private VLAN. This mesh private VLAN must not be used as a VLAN for any other virtual AP.

1. Edit the Mesh Radio profile for the remote mesh portal according to the procedure described in [Creating or Editing a Mesh Radio Profile on page 571](#).
2. Set the **Mesh Private VLAN** parameter to define a VLAN ID (0–4094) for control traffic between an remote mesh point and mesh nodes.
3. Click **Submit**.
4. Click **Pending Changes**.
5. In the **Pending Changes** window, select the check box and click **Deploy Changes**.

Next, assign the remote mesh points with the same mesh cluster profile, 802.11a and 802.11g RF management profiles, and mesh radio profile as the remote mesh portal. If you have defined an AP group for all your remote mesh points, you can just assign the required profiles to the remote mesh point AP group. Otherwise, you must assign the required profiles to each individual remote AP.

### Step 3: Assign the Mesh Radio Profile to a Remote Mesh AP

Follow the procedures described in [Assigning a Mesh Radio Profile to a Mesh AP or AP Group on page 574](#)

### Step 4: Assign an RF Management Profile to a Remote Mesh AP

Follow the procedures described in [In the CLI on page 533](#) to assign an 802.11a or 802.11g RF management profile to the remote mesh AP.

### Step 5: Assign a Mesh Cluster Profile

Follow the procedures described in [Configuring Mesh Cluster Profiles on page 567](#) to assign a mesh cluster profile to the remote mesh AP.



---

If you configure multiple cluster profiles with different cluster priorities, you manually override the link metric algorithm because the priority takes precedence over the path cost. In this scenario, the mesh portal uses the profile with the highest priority to bring-up the mesh network.

---

### Step 6: Configuring a DHCP Pool

In this next step, you must configure a DHCP pool where the DHCP server is on the subnet associated with mesh private VLAN. Mesh points get their IP address from this subnet pool. To complete this task, refer to the procedure described in [Enabling Remote AP Advanced Configuration Options](#).

### Step 7: Configuring the VLAN ID of the Virtual AP Profile

Follow the procedure described in [WLAN SSID Profiles on page 429](#) to configure the VLAN ID of the remote mesh AP's SSID profile. The VLAN of this Virtual AP must have the same VLAN ID as the mesh private VLAN.

## Provisioning a Remote Mesh Portal In the CLI

Reprovisioning the AP causes it to automatically reboot. When you use the CLI to reprovision a mesh node, you may also provision other AP settings.

```
(host) [mynode] (config) #provision-ap
    read-bootinfo ap-name <name>
    mesh-role remote-mesh-portal
    reprovision ap-name <name>
```

ArubaOS high availability and Virtual Router Redundancy Protocol (VRRP) redundancy features allow network administrators to significantly reduce network downtime and client traffic disruption during network upgrades or unexpected failures.

## Getting Started with High Availability and VRRP Solutions

This chapter describes ArubaOS high availability and VRRP redundancy solutions, and lists the procedures to configure these features.

### Learn more about High-Availability and VRRP Redundancy

For information to help you plan your redundancy solution, refer to the following sections of this document:

- [High Availability Overview on page 590](#)
- [High Availability with Extended Capacity on page 593](#)
- [Client State Synchronization on page 594](#)
- [High Availability Inter-Controller Heartbeats on page 595](#)
- [Configuring High Availability on page 595](#)

### Configure a VRRP Solution

For more information on VRRP redundancy on Multi-Master topologies, see [VRRP Redundancy for Multi-Master Topologies on page 597](#).

## High Availability Overview



---

This section is applicable only for a stand-alone controller or a managed device on the Mobility Master.

---

When you enable the High Availability WLAN redundancy solution, campus APs that lose contact with their active controller do not need to re-bootstrap when they failover to the standby controller, significantly reducing AP downtime. APs using the High Availability features regularly communicate with the standby controller so the controller has a light workload to process in the event of an AP failover. This results in very rapid failover times and a shorter client reconnect period. Therefore, High Availability is usually preferable to other redundancy solutions (like a backup-LMS) that can put a heavy load on the backup controller during failover, which results in slower failover performance.



---

High Availability supports failover for campus APs using tunnel, or decrypt-tunnel, or bridge forwarding modes. It does not support failover for remote APs.

---

### Controller Role Types

A controller using this feature can have one of three high availability roles: **active**, **standby**, or **dual**. An active controller serves APs, but cannot act as a failover standby controller for any AP except those that it serves as an active controller. A standby controller acts as a failover backup controller, but cannot be configured as the

primary controller for any AP. A dual controller can support both roles, acting as the active controller for one set of APs, and a standby controller for another set of APs.



---

A controller is assigned the **dual** role if no other role is specified

---

## AP Communication with Controllers

The High Availability features work across Layer-3 networks, so there is no need for a direct Layer-2 connection between controllers in a high-availability group.

When the AP first connects to its active controller, the active controller provides the IP address of a standby controller, and the AP attempts to establish a tunnel to the standby controller. If an AP fails to connect to the first standby controller, the active controller will select a new standby controller for that AP, and the AP will attempt to connect to that standby controller.

An AP will failover to its backup controller if it fails to contact its active controller through regular heartbeats and keepalive messages, or if the user manually triggers a failover using the WebUI or CLI. If inter-controller heartbeat is enabled, APs can failover even when the standby controller misses its heartbeats with the active controller.

High Availability for bridge mode is supported on Campus APs. In this mode, the controller sends ACL Names to the APs instead of the ACL IDs. These APs generate and maintain the mapping between the ACL Name and ACL Id . In the event of a failover the ACL Name is sent to the AP from the stand-by controller. Since AP maintains the mapping, the ACL Ids remain intact during a failover.

## Redundancy and High Availability Requirements and Limitations

A backup controller can use the High Availability feature. However, a backup controller can only accept standby connections from APs, and will not serve active APs as long as its master redundancy role is **backup**.

This type of High Availability deployment has the following requirements and limitations:

- A backup-master controller can only form an active-standby pair with the master controller.
- The backup master cannot terminate active APs.
- Both the backup-master and master controllers must be configured with the **dual** controller role.
- The controller IP address defined in the high availability group profile must be the IP address of the VRRP interface.
- **The inter-controller heartbeat feature is not recommended for backup-master and master controller pairs using the High Availability feature.** If the inter-controller heartbeat feature is enabled in a high availability group profile for redundant masters, the inter-controller failover time must be greater than the VRRP failover time. That is, the (heartbeat interval \* heartbeat threshold) value should be greater than the (advertisement time \* 3 + preemption delay + skew time [which is based on priority]).

## High Availability Deployment Models

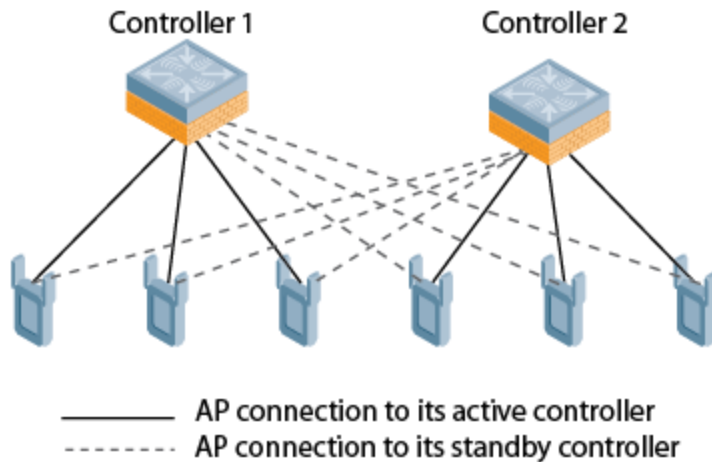
High availability supports the following deployment models.

- [Active/Active Deployment Model on page 592](#)
- [1:1 Active/Standby Deployment Model on page 592](#)
- [N:1 Active/Standby Deployment Model](#)

## Active/Active Deployment Model

In this model, two controllers are deployed in dual mode. Controller one acts as a standby for the APs served by controller two, and vice-versa. To ensure that each AP gets a standby, Aruba recommends not to have AP count more than 50% of the platform limit; if one controller fails, all the APs served by that controller would failover to the other controller, providing high availability redundancy to all APs in the cluster.

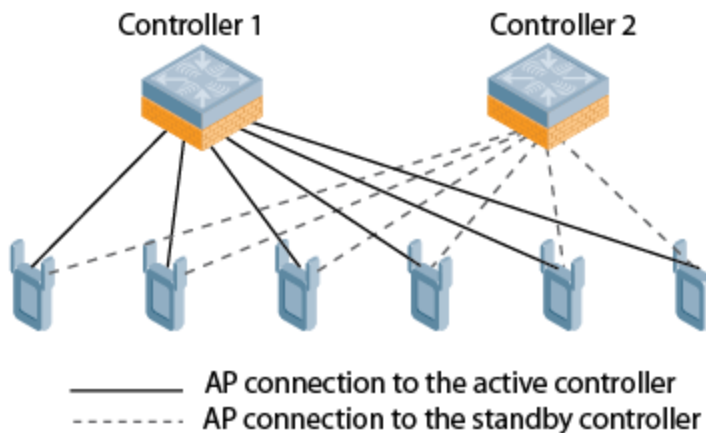
**Figure 40** Active-Active HA Deployment



## 1:1 Active/Standby Deployment Model

In this model, the active controller supports up to 100% of its rated capacity of APs, while the other controller is idle in standby mode. If the active controller fails, all APs served by the active controller will failover to the standby controller.

**Figure 41** 1:1 Active/Standby Deployment



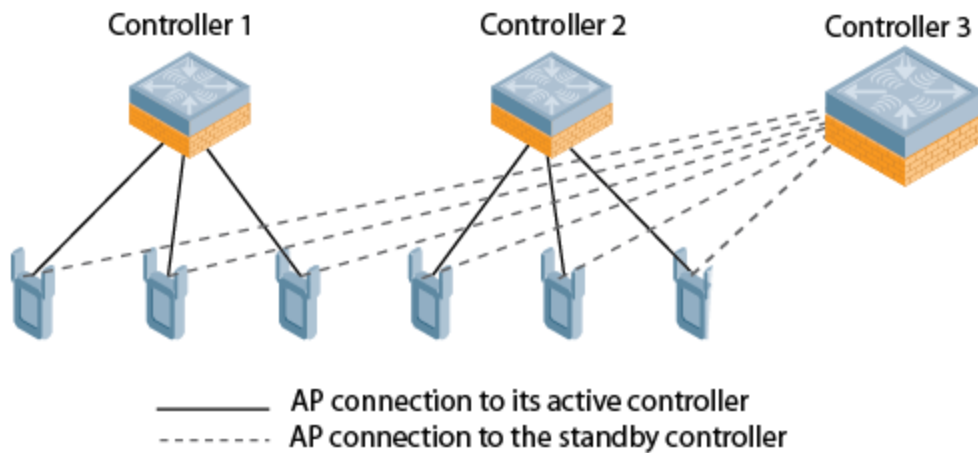
## N:1 Active/Standby Deployment Model

In this model, the active controller supports up to 100% of its rated AP capacity, while the other controller is idle in standby mode. If an active controller fails, all APs served by the active controller will failover to the standby controller. This model requires that the AP capacity of the standby controller is able to support the total number of APs distributed across all active controllers in the cluster.

In the cluster shown in the example below, the standby controller has enough AP capacity to support the total number of APs terminating at the active controllers ( Controller 1 and Controller 2).



**Figure 42** 1:1 Active/Standby Deployment



## High Availability with Extended Capacity

The standby controller over-subscription feature allows a standby controller to support connections to standby APs beyond the controller's original rated AP capacity. The following section of this document gives and lists requirements and capacity limitations for this feature. For more details on enabling the extended standby controller capacity, see [Configuring High Availability on page 595](#).

A controller that acts as a standby controller can oversubscribe to standby APs by up to four times that controller's rated AP capacity, as long as the tunnels consumed by the standby APs do not exceed the maximum tunnel capacity for that standby controller.

### Feature Requirements

This feature can be enabled on managed devices where centralized licensing is enabled on the active and standby Mobility Master, or on stand-alone controllers that are not using VRRP-based redundancy. If centralized licensing is disabled, the standby AP over-subscription feature is also disabled. Standby controller over-subscription and the high availability state synchronization features are mutually exclusive and cannot be enabled simultaneously. If your deployment uses the state synchronization feature, you must disable it before you enable standby controller over-subscription.

### Standby Controller Capacity

The following table describes the AP over-subscription capacity maximum supported tunnels and the controllers that support this feature. This feature is not applicable for 70xx controllers.

**Table 121:** Controller Support for Standby Oversubscription

Controller Model	Standby AP Capacity	Maximum Tunnels Supported
7205	4x rated AP capacity	8192 tunnels
7210	4x rated AP capacity	16384 tunnels
7220	4x rated AP capacity	32768 tunnels

Controller Model	Standby AP Capacity	Maximum Tunnels Supported
7240	4x rated AP capacity	65536 tunnels

To determine the number of standby tunnels consumed by APs on each active controller, multiply the number of APs on the active controllers by the number of BSSIDs per AP. For example, consider a deployment with four active 7210 controllers that each have 512 APs with 8 BSSIDs. The APs on each active controller consume (512 \* 8) tunnels, for a combined total of 16,384 tunnels. A single 7210 controller using the standby controller over-subscription feature can act as the standby controller for all four active controllers in this example because this topology is within the 4x rated AP capacity limit and maximum tunnel limit for the 7210 controller model.

If the network administrator later changed all the APs in this deployment to support 10 BSSIDs, each active controller would use (512 \* 10) tunnels, for a combined total of 20,480 tunnels on the four active controllers. The tunnels required by the APs on the active controllers would then exceed the maximum tunnel limit for the standby controller, so the standby controller can no longer support all APs on the active controllers. Dynamic changes to configuration (such as the addition of BSSIDs to any AP group) causes all the standby APs to disconnect and reconnect back to the standby controller defined by their updated configuration.

To view information about the numbers of currently associated APs and supported BSS tunnels, and the remaining capacity for additional APs and BSS tunnels, issue the CLI command **show ha oversubscription statistics**.

### AP Failover

If a standby controller reaches its AP over-subscription capacity or exceeds its maximum BSSID limit, the standby controller drops any subsequent standby AP connections. A dropped AP attempts to reconnect to the standby controller, but after it exceeds the maximum number of request retries, the AP informs the active controller that it is unable to connect to the standby controller. The active controller then prompts the AP to create a standby tunnel to another standby controller, if one is configured.

If an active controller fails, the APs on the active controller failover to the standby controller. Once the standby controller has reached its capacity for active APs, it terminates tunnels to any standby APs that the controller can no longer serve. When these APs detect that there is no longer a heartbeat between the AP and the standby controller, they notify their active controller that they can no longer connect to the standby. The active controller then prompts the APs to establish standby tunnels to another standby controller, if one is configured.

## Client State Synchronization

Client state synchronization allows faster client reauthentication in the event of a controller failure by synchronizing PMK and Key cache entries between active and standby controllers. When you enable this feature, clients only need to perform a four-way key exchange to reconnect to the network (instead of performing a full authentication to the RADIUS server), dramatically shortening the time required for the client to reconnect.



The following section of this document describes topologies, guidelines, and limitations for this feature. To view the procedure for enabling the client state synchronization feature, see [Configuring High Availability](#).

### Feature Guidelines and Limitations

Note the following guidelines and limitations before enabling this feature in your high availability deployment:

- Only APs that support 802.11n and 802.11ac support client state synchronization.
- The client state synchronization and standby controller over-subscription features are mutually exclusive and cannot be enabled simultaneously. If your deployment uses the standby controller over-subscription feature, the feature must be disabled before enabling state synchronization.

## High Availability Inter-Controller Heartbeats

The high availability inter-controller heartbeat feature allows for faster AP failover from an active controller to a standby controller, especially in situations where the active controller reboots or loses connectivity to the network.

The inter-controller heartbeat feature works independently from the AP mechanism that sends heartbeats from the AP to the controller. If enabled, the inter-controller heartbeat feature supersedes the AP's heartbeat to its controller. As a result, if a standby controller detects missed inter-controller heartbeats from the active controller, it triggers its standby APs to failover to the standby controller, *even if those APs have not detected any missed heartbeats between the APs and their active controller*. Use this feature with caution in deployments where the active and standby controllers are separated over high-latency WAN links.

When this feature is enabled, the standby controller starts sending regular heartbeats to an AP's active controller as soon as the AP has an UP status on the standby controller. The standby controller initially flags the active controller as **unreachable**, but changes its status to **reachable** as soon as the active controller sends a heartbeat response. If the active controller later becomes unreachable for the number of heartbeats defined by the heartbeat threshold (default of 5 missed heartbeats), the standby controller immediately detects this error and informs the APs using the standby controller to failover from the active controller to the standby controller. If, however, the standby controller never receives an initial heartbeat response from the active controller, and therefore never marks the active controller as initially reachable, the standby controller will not initiate a failover.

This feature is disabled by default. It can be used in conjunction with the high availability state synchronization feature only in topologies that use a single active and standby controller, or a pair of dual-mode active controllers that act as standby controllers for each other. High availability inter-controller heartbeats can be enabled and configured in the high-availability group profile using the WebUI or Command-Line interface.

For more details on how to enable and configure inter-controller heartbeats, see [Configuring High Availability on page 595](#).

## Configuring High Availability

The high availability feature supports redundancy models with an active controller pair, or an active/standby deployment model with one backup controller supporting one or more active controllers. Each of these clusters of active and backup controllers comprises a high-availability group. All active and standby controllers within a single high-availability group must be deployed in independent masters topology. An independent masters topology requires all independent master controllers to have the same WLAN configuration.

### Configuring High Availability

Configure the high availability feature in the WebUI or CLI using the high-availability and high-availability group profiles.

#### In the WebUI

To configure High Availability using the WebUI:

1. In **Mobility Master > standalone**, navigate to **Configuration > Services > Redundancy**.
2. Click the **HA Groups** accordion and click the + icon. A pop-up window appears.

3. In the **Name** field, enter a name for the new HA group.
4. Configure an IPv4 or IPv6 address for the controller.
  - a. Click the + icon in the **HA Controller IPv4** or **HA Controller IPv6** fields. The **Add HA Controller IP** window opens. Enter an IP address.



---

IPv4 and IPv6 controllers can be part of the same HA group profile. However, HA works only between controllers of same IP format.

---

- b. Click the **Role** drop-down list to assign a role to the controller. The IP address of each controller must be reachable by APs and must be the IP address that appears in the **Configuration > Controller > System settings** tab of the controller WebUI, or in the output of the **show controller-ip** CLI command. The role can be one of the following options:
      - **Active:** Controller is active and serving APs.
      - **Dual:** Controller serves some APs and acts as a standby controller for other APs.
      - **Standby:** Controller does not serve APs and only acts as a standby in case of failover.
    - c. Click **OK** to add the controller to the group.
  5. (Optional) Select **Enabled** from the **Pre-emption** drop-down list to enable the failed over APs to attempt to connect back to its original active controller once the controller is reachable again. When you enable this setting, the AP waits for the time specified by the **lms-hold-down-period** parameter defined in the **ap system** profile before the AP attempts to switch back from the standby controller to the original controller.
  6. (Optional) The standby controller over-subscription feature allows a standby controller to support connections to standby APs beyond the controller's original rated AP capacity. To enable this feature, click the **Over subscription** check box.
  7. (Optional) Click the **State synchronization** drop-down list and select **Enable** to enable this feature. State synchronization improves failover performance by synchronizing client authentication state information from the active controller to the standby controller. (For more information about state synchronization, see [Client State Synchronization on page 594](#)).



---

State synchronization is not applicable for IPv6 controllers.

---

8. (Optional) Click the **Heartbeat** drop-down list and select **Enabled** to enable the high availability inter-controller heartbeat features, which enable faster AP failover from an active controller to a standby controller, especially in situations where the active controller reboots or loses connectivity to the network. To edit the default heartbeat threshold and interval values:
        - Enter a heartbeat threshold in the **Heartbeat threshold** field to define the number of heartbeats that must be missed before the APs are forced to failover to the standby controller. This value must be between 3 and 10, inclusive.
        - Enter a heartbeat interval in the **Heartbeat interval (ms)** field to define how often inter-controller heartbeats are sent. This value must be between 100 and 1000 ms, inclusive.
      9. (Optional) If you enabled the state synchronization feature in Step [7](#), enter a pre-shared key into the **Pre-shared key** and **Retype pre-shared key** fields.
      10. Click **Submit**.
      11. Click **Pending Changes**.
      12. In the **Pending Changes** window, select the check box and click **Deploy changes**.

## In the CLI

To configure a High Availability group using the command-line interface, access the CLI in config mode and issue the following commands. The high availability group profile should be configured with a pair of IPv4 controller addresses and pair of IPv6 controller addresses to allow an IPv4 or IPv6 access point to establish a connection to a standby controller.

```
(host) [mynode] (config) #ha group-profile <profile>
(host) [mynode] (HA group information "default") #controller <ip> role [active/dual/standby]
```

A controller using the high availability features must be defined as a member of a high availability group. To add a controller to the new high availability group, issue following CLI command:

```
(host) [mynode] (config) #ha group-membership <ha-group>
```

## VRRP Redundancy for Multi-Master Topologies



---

The term controller in this section refers to stand-alone controllers running ArubaOS 8.0.

---

The master controller in the Aruba user-centric network acts as a single point of configuration for global policies such as firewall policies, authentication parameters, and RF configuration to ease the configuration and maintenance of a wireless network. It also maintains a database related to the wireless network that you can use to make adjustments (automated or manual) in reaction to events that cause a change in the environment (such as an AP becoming unavailable).

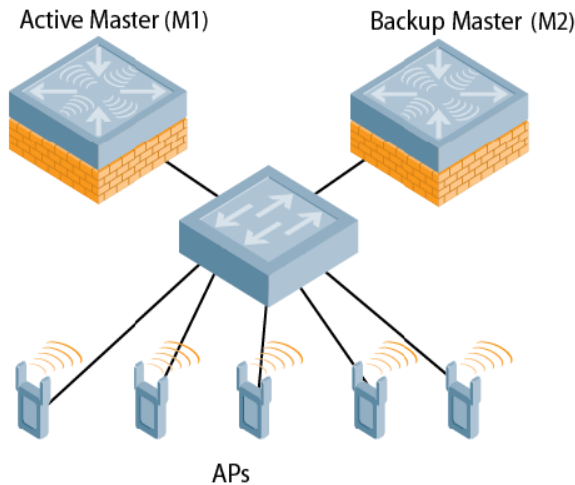
The master controller is also responsible for providing the configuration for an AP to complete its boot process. If the master controller becomes unavailable, the network continues to run without any interruption. However, any change in the network topology or configuration will require the availability of the master controller.

To maintain a highly redundant network, the administrator can use a controller to act as a hot standby for the master controller. The underlying protocol used is the same as in master-local redundancy.

ArubaOS supports VRRP-based LMS redundancy in a deployment with master-master redundancy. In the topology below, when an AP connects to the master controller (M1), the AP receives a standby IP, which it uses to establish a standby connection to the backup master (M2). If the active master becomes unreachable or reboots, the backup master changes its VRRP role to master and accepts active AP connections.

When M1 comes back up, it initially acts as a backup master, and APs associated to M2 establish a standby connection to M1. When the controllers change roles and M1 becomes the active master once again, M2 forces the APs to use M1 as their active master. If an AP has not established a connection to M1 before it disassociates from M2, the AP reboots before it reconnects back to M1.

**Figure 43** Redundancy with a Active-Backup Master Controller Pair



When a VRRP instance is configured on the controller VLAN, there would be no change in the VRRP state if the failover scenario was tested by shutting down the port or bringing down the vlan. The controller remains in the Master state and sends VRRP advertisements, which do not reach the peer controller. When the port is down, the peer controller becomes the Master. However, when the port on the previous master is enabled, it takes over the Master state. The peer controller moves out of the master state when the original master sends a higher priority advertisement, even when preemption is not enabled. The peer controller will not be preempted if the master controller crashes or reboots.



## Configuring a Primary and Backup Master for Failover Redundancy

You can use either the WebUI or CLI to configure VRRP on the primary and backup master controllers.

### In the WebUI

1. In **Mobility Master > standalone**, navigate to **Configuration > Services > Redundancy**.
2. Expand the **Virtual Router Table**, section.
3. Click the **+** icon to add a new virtual router. The **New Virtual Router** fields appear.
4. Select the IP version from the **IP Version** drop-down list.
5. Select the VLAN on which you want to configure VRRP from the **VLAN** drop-down list.
6. Set **Admin State** to **UP**.
7. Specify the priority value in the **Priority** field. For a backup controller, use the default priority value of 100. For the primary controller, use the a priority value higher than the default, such as 110.
8. Configure other VRRP parameters as described in [Table 122](#) .
9. Click **Submit**.
10. Click **Pending Changes**.
11. In the **Pending Changes** window, select the check box and click **Deploy changes**
12. Repeat steps 1-11 to configure VRRP on the other controller in the primary and backup redundant pair.

**Table 122: VRRP Configuration Parameters**

Parameter	Description
ID	The ID uniquely identifies this VRRP instance. For ease in administration, you should configure this with the same value as the VLAN ID.
Description	This is an optional text description to describe the VRRP instance.
IP version	Select IPv4 \ IPv6 from the drop-down list box.
Authentication Password	This is an optional password of up to eight characters that can authenticate VRRP peers in their advertisements. If this is not configured, there is no authentication password.
Retype authentication password	Reconfirm the password, if configured.
IP address	Based on the selection made in the IP version field, either IP Address \ IPv6 Address is displayed. This is the virtual IP address that will be owned by the elected VRRP master. Ensure that the same IP address and VRRP ID is used on each member of the redundant pair.  Note: The IP address must be unique and cannot be the loopback address of the controller. A maximum of only two virtual IPv6 addresses can be configured on each VRRP instance. Only IPv6 address format is supported for the v6 instance.
Priority	Priority level of the VRRP instance for the controller. This value is used in the election mechanism for the <i>master</i> . When configuring VRRP on a local controller, use the default priority value of 100. For a master controller, use a higher priority value, such as 110.
Advertisement interval (secs)	This is the interval, in seconds, between successive VRRP advertisements sent by the current <i>master</i> . The default interval time is recommended.  Default: 1 second
Enable router Pre-emption	Selecting this option means that a controller can take over the role of <i>master</i> if it detects a lower priority controller currently acting as <i>master</i> .
Pre-emption delay (secs)	Specifying a value enables the delay timer. The timer is triggered when the VRRP state moves out of backup or init state to become a master. This is applicable only if you enable router pre-emption.  When the timer is triggered, it forces VRRP to wait for a specified period of time, so that all the applications are ready before coming up. This prevents the APs from connecting to the controller before it can receive them. In the meantime, if there is an advertisement from another VRRP, the VRRP stops the timer and does not transition to master.
Admin state	Administrative state of the VRRP instance. To start the VRRP instance, change the admin state to <b>UP</b> in the WebUI.
VLAN	VLAN on which the VRRP protocol runs.

**Table 122: VRRP Configuration Parameters**

Parameter	Description
Tracking master up-time	(Optional) Perform VRRP priority tracking based on how long the controller has been the master. This feature is designed to ensure that a master will only be allowed to take and maintain control of the VRRP if it has been up for a certain amount of minutes (0-1440). This prevents an issue where a device that is periodically going up and down assumes the role of primary master.
Tracking master up-time priority	(Optional) The additional priority given to the master once it has been up for the time interval defined by the <b>Tracking Master Up-time</b> parameter.
Tracking VRRP master state ID	(Optional) Perform tracking based on the UP or DOWN state of another VRRP master by specifying the VRRP ID of the master to be tracked.
Tracking VRRP master state priority	(Optional) The priority taken away from a VRRP master if it is in a DOWN state. The priority levels are returned to their previous state when the VRRP master comes back up.
Tracking VLAN	(Optional) Perform VRRP priority tracking based on the UP or DOWN state of a VLAN. Click the + icon below the <b>Tracking VLAN</b> table and specify the following values: <ul style="list-style-type: none"> <li>VLAN Id: ID of the VLAN to be tracked.</li> <li>Subtract: Priority level to be subtracted from the controller's VRRP priority if the tracked VLAN goes down.</li> </ul>
Tracking interface	(Optional) Perform VRRP priority tracking based on the UP or DOWN state of a specific interface. Click the + icon below the <b>Tracking Interface</b> table and specify the following values: <ul style="list-style-type: none"> <li>Interface: Interface Port to be tracked.</li> <li>Subtract: Priority level to be subtracted from the controller's VRRP priority if the tracked interface goes down.</li> </ul>

### In the CLI

Execute the following commands to configure a new virtual router:

```
(host) [mynode] (config) #vrrp <id>
(host) [mynode] (config-submode)#ip address <ip-address>
(host) [mynode] (config-submode)#vlan <vlanID>
(host) [mynode] (config-submode)#priority <0-255>
```

### Configuring APs to use the VRRP IP

Configure the APs associated with the master controller to terminate their tunnels on the VRRP virtual-IP address. To specify the controller to which an AP or AP group tunnels client traffic, you configure the LMS IP in the AP system profile on the master controller.



This configuration must be executed on the master controller; the APs obtain their configuration from the master controller.

### In the WebUI

Follow the procedure below to configure VRRP on an AP system profile:

1. In **Mobility Master > standalone**, navigate to **Configuration > System > Profiles**.
2. In **All Profiles > AP**, expand **AP system**.



3. Select the AP system profile for which you want to configure VRRP.
4. Click the **LMS Settings** accordion and enter the virtual IP address into the **LMS IP** field.
5. Click **Save**.
6. Click **Pending Changes**.
7. In the **Pending Changes** window, select the check box and click **Deploy changes**.

Follow the procedure below to configure VRRP for an AP group:

1. In **Mobility Master > standalone**, navigate to **Configuration > AP Groups**.
2. Select the **More** tab from the selected AP group table.
3. Enter the virtual IP address into the **LMS IP address** field. For IPv6 address, enter the value in the **LMS IPv6 address** field.
4. Click **Submit**.
5. Click **Pending Changes**.
6. In the **Pending Changes** window, select the check box and click **Deploy changes**.

### In the CLI

Execute the following commands to configure VRRP on an AP system profile and apply it to an AP profile and an AP group:

```
(host) [mynode] (config) #ap system-profile <profile-name>
(host) [mynode] (AP system profile "<profile-name>") #lms-ip <ip-address>
(host) [mynode] (AP system profile "<profile-name>") #ap-name <ap-profile-name>
(host) [mynode] (AP name "<ap-profile-name>") #ap-system-profile <profile-name>
(host) [mynode] (AP name "<ap-profile-name>") #exit
(host) [mynode] (config) #ap-group <ap-group-name>
(host) [mynode] (AP group "<ap-group-name>") #ap-system-profile <profile-name>
```

If DNS resolution is the chosen mechanism for the APs to discover their master controller, ensure that the name *aruba-master* resolves to the same virtual IP address configured as a part of the master redundancy.

## Configuring Database Synchronization

In a redundant master controller scenario, you can configure a redundant pair to synchronize their WMS and local user databases. You can either manually or automatically synchronize the databases.

When manually synchronizing the database, the active VRRP master synchronizes its database with the standby. The command takes effect immediately.

When configuring automatic synchronization, you set how often the two controllers synchronize their databases. To ensure successful synchronization of database events, you should set periodic synchronization to a minimum period of 20 minutes.

### In the WebUI

1. In **Mobility Master > standalone**, navigate to the **Configuration > Services > Redundancy** page.
2. Under **Master Redundancy**, do the following:
  - a. Select **Enabled** in the **Database synchronization** drop-down list. This enables database synchronization.
  - b. Enter the frequency of synchronizing the databases in the **Sync period** field. A minimum value of 20 minutes is recommended.
3. Click **Submit**.
4. Click **Pending Changes**.
5. In the **Pending Changes** window, select the check box and click **Deploy changes**.

## In the CLI

Use the following commands to configure database synchronization.

```
(host) [mynode] (config) #database synchronize period
```

To view the database synchronization settings on the controller, use the following command:

```
(host) [mynode] #show database synchronize
```

## Migrating from VRRP or Backup-LMS Redundancy

High Availability: Fast Failover provides redundancy for APs, but not for controllers. Deployments that require master controller redundancy should continue to use an existing VRRP redundancy solution. If your deployment currently uses a backup-LMS or VRRP redundancy solution, use the following procedures to migrate to a High-Availability-based solution. For more information on this topology, see [High Availability Deployment Models on page 591](#).

### Migrating from VRRP Redundancy

Perform the following steps to migrate from VRRP to High-Availability redundancy:

1. Remove the VRRP IP address as the LMS IP address of the AP.  

```
(host) [mynode] (AP system profile) #no lms-ip
```
2. Configure the AP to use the active controller's IP address (not VRRP the IP address) as the LMS-IP for the AP.  

```
(host) [mynode] (AP system profile) #lms-ip <ipaddress>
```
3. Configure the AP to use the standby controller IP address (not VRRP the IP address) as the backup LMS-IP for the AP.  

```
(host) [mynode] (AP system profile) #bkup-lms-ip <ipaddress>
```
4. Configure the master controller with a dual role in the high-availability group profile.  

```
(host) [mynode] (config) #ha group-profile grp1  
(host) [mynode] (HA group information "grp1"): controller <ipaddress> role dual
```
5. Configure the standby controller with a dual role in the high-availability group profile.  

```
(host) [mynode] (HA group information "grp1"): controller <ipaddress> role dual
```

### Migrating from Backup-LMS Redundancy

Perform the following steps to migrate from Backup-LMS to High-Availability redundancy and maintain the existing configuration as defined by the **lms-ip** and **bkup-lms-ip** parameters in the AP system profile.

1. Configure the controller serving the AP with a dual role in the high-availability group profile.  

```
(host) [mynode] (config) #ha group-profile grp1  
(host) (HA group information "grp1"): controller <ipaddress> role dual
```
2. Configure the AP's standby controller with a dual role in the high-availability group profile.  

```
(host) [mynode] (HA group information "grp1"): controller <ipaddress> role dual
```

A *mobility domain* is a group of Aruba managed devices among which wireless users can roam without losing their IP address. Mobility domains are not tied with the Mobility Master; thus, it is possible for a user to roam between managed devices as long as all the managed devices belong to the same Mobility Master.

You enable and configure mobility domains only on Aruba managed devices. No additional software or configuration is required on wireless clients to allow roaming within the domain.

Topics in this chapter include:

- [Understanding Aruba Mobility Architecture on page 603](#)
- [Configuring Mobility Domains on page 604](#)
- [Tracking Mobile Users on page 606](#)
- [Configuring Advanced Mobility Functions on page 608](#)
- [Understanding Bridge Mode Mobility Deployments on page 617](#)
- [Monitoring Network Traffic Using IPFIX on page 618](#)
- [Enabling Mobility Multicast on page 621](#)

## Understanding Aruba Mobility Architecture

Aruba's layer-3 mobility solution is based on the Mobile IP protocol standard, as described in **RFC 3344**, IP Mobility Support for IPv4. This standard addresses users who need both network connectivity and mobility within the work environment.

Unlike other layer-3 mobility solutions, an Aruba mobility solution does not require that you install mobility software or perform additional configuration on wireless clients. The Aruba managed devices perform all functions that enable clients to roam within the mobility domain.

In a mobility domain, a *mobile client* is a wireless client that can change its point of attachment from one network to another within the domain. A mobile client receives an IP address (*a home address*) on a *home network*.

A mobile client can detach at any time from its home network and reconnect to a *foreign network* (any network other than the mobile client's home network) within the mobility domain. When a mobile client is connected to a foreign network, it is bound to a *care-of address* that reflects its current point of attachment. A care-of address is the IP address of the Aruba managed device in the foreign network with which the mobile client is associated.

The *home agent* for the client is the managed device at which the client appears for the first time upon joining the mobility domain. The home agent is the single point of contact for the client when the client roams. The *foreign agent* for the client is the managed device which handles all Mobile IP communication with the home agent on behalf of the client. Traffic sent to a client's home address is intercepted by the home agent and tunneled for delivery to the client on the foreign network. On the foreign network, the foreign agent delivers the tunneled data to the mobile client.

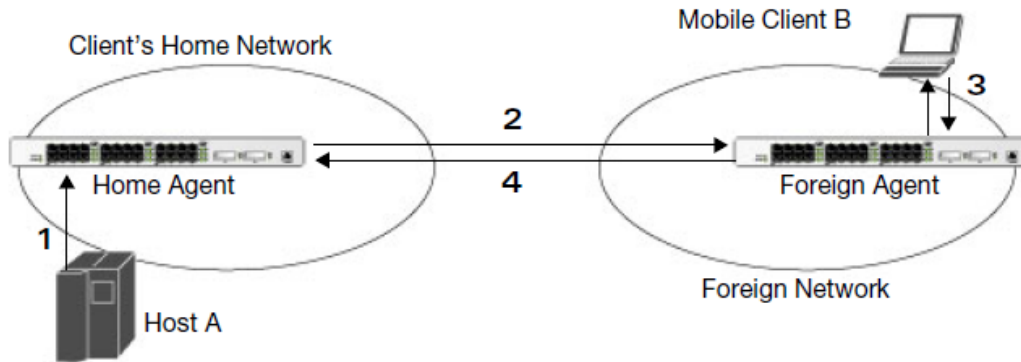
[Figure 44](#) shows the routing of traffic from Host A to Mobile Client B when the client is away from its home network. The client's care-of address is the IP address of the Aruba managed device in the foreign network.

The numbers in the [Figure 44](#) correspond to the following descriptions:

1. Traffic to Mobile Client B arrives at the client's home network via standard IP routing mechanisms.

2. The traffic is intercepted by the home agent in the client's home network and tunneled to the care-of address in the foreign network.
3. The foreign agent delivers traffic to the mobile client.
4. Traffic sent by Mobile Client B is also tunneled back to the home agent.

**Figure 44** Routing of Traffic to Mobile Client within Mobility Domain



## Configuring Mobility Domains

Before configuring a mobility domain, you should determine the user VLAN(s) for which mobility is required. For example, you may want to allow employees to be able to roam from one subnetwork to another. All Managed devices that support the VLANs into which employee users can be placed should be part of the same mobility domain.



Aruba mobility domains are supported only on Aruba managed devices.

A managed device can be part of multiple mobility domains, although it is recommended that a managed device belong to only one domain. The managed device in a mobility domain do not need to be managed by the same Mobility Master.

You configure a mobility domain on a Mobility Master; the mobility domain information is pushed to all managed device that are managed by the Mobility Master. On each managed device, you must specify the *active* domain (the domain to which the managed device belongs). If you do not specify the active domain, the managed device will be assigned to a predefined “default” domain.

The basic tasks you need to perform to configure a mobility domain are listed below. The sections following describe each task in further detail.

**Table 123:** Tasks to Configure a Mobility Domain

On a Mobility Master:	On all managed devices in the mobility domain:
<ul style="list-style-type: none"> <li>Configure the mobility domain, including the entries in the home agent table (HAT)</li> </ul>	<ul style="list-style-type: none"> <li>Enable mobility (disabled by default)</li> <li>Join a specified mobility domain (not required for “default” mobility domain)</li> </ul>

You can enable or disable IP mobility in a virtual AP profile (IP mobility is enabled by default). When you enable IP mobility in a virtual AP profile, the ESSID that is configured for the virtual AP supports layer-3 mobility. If you disable IP mobility for a virtual AP, any clients that associate to the virtual AP will not have mobility service.

## Configuring a Mobility Domain

You configure mobility domains on Mobility Master. All managed devices managed by the Mobility Master share the list of mobility domains configured on the Mobility Master. Mobility is disabled by default and must be explicitly enabled on all managed devices that will support client mobility. Disabling mobility does not delete any mobility related configuration.

The home agent table (HAT) maps a user VLAN IP subnet to potential home agent addresses. When you enable mobility the managed device to which the client connects for the first time becomes its home agent. The mobility feature uses the HAT table to locate a potential home agent for each mobile client, and then uses this information to perform home agent discovery. To configure a mobility domain, you must assign a home agent address to at least one managed device with direct access to the user VLAN IP subnet. (Some network topologies may require multiple home agents.)

It is recommended that you configure the switch IP address to match the AP's managed device, *or* define the Virtual Router Redundancy Protocol (VRRP) IP address to match the VRRP IP used for managed device redundancy. Do not configure both a switch IP address and a VRRP IP address as a home agent address, or multiple home agent discoveries may be sent to the managed device.



---

All user VLANs that are part of a mobility domain must have an IP address that can correctly forward layer-3 broadcast multicast traffic to clients when they are away from the home network.

---

The mobility domain named “default” is the default active domain for all managed devices. If you need only one mobility domain, you can use this default domain. However, you also have the flexibility to create one or more user-defined domains to meet the unique needs of your network topology. Once you assign a managed device to a user-defined domain, it automatically leaves the “default” mobility domain. If you want a managed device to belong to both the “default” and a user-defined mobility domain at the same time, you must explicitly configure the “default” domain as an active domain for the managed device.

### In the WebUI

1. In a **Managed Device** node hierarchy, navigate to **Configuration > Services** page and select the **IP Mobility** tab.
2. Click **Mobility Domain** accordion. Select **Enabled** for the **Enable IP mobility** drop-down list.
3. To configure the default mobility domain, select the default domain in the **IP Mobility Configuration** table.
4. To create a new mobility domain, click + in the **IP Mobility Configuration** table. Enter the value of the **Name** and **Description** fields in the **Create Ip Mobility** table.
5. Click **Submit**.
6. Select the newly-created domain name and click + in the **IP Mobility Configuration** table. The **Home Agent** table is displayed.
7. Click + in the **Home Agent** table. A **Create Home Agent** table is displayed.
8. Enter the value of the **IP** and **Description** fields in the **Create Home Agent** table.
9. Click **Submit**.
10. Click **Pending Changes**.
11. In the **Pending Changes** window, select the check box and click **Deploy changes**.

### In the CLI

```
(host) [md] (config)#router mobile
(host) [md] (config)#ip mobile domain <name>
(host) [md] (config-submode)#hat <home-agent> description <dscr>
```

To view currently-configured mobility domains in the CLI, use the `show ip mobile domain` command.

Ensure that the ESSID to which the mobile client will connect supports IP mobility. You can disable IP mobility for an ESSID in the virtual AP profile (IP mobility is enabled by default). If you disable IP mobility for a virtual AP, any client that associates to the virtual AP will not have mobility service.

## Joining a Mobility Domain

Assigning a managed device to a specific mobility domain is the key to defining the roaming area for mobile clients. You should take extra care in planning your mobility domains and survey the user VLANs and managed device to which clients can roam, to ensure that there are no roaming holes.

All managed device are initially part of the “default” mobility domain. If you use the default mobility domain, you do not need to specify this domain as the active domain on a managed device. However, once you assign a managed device to a user-defined domain, the default mobility domain is no longer an active domain on the managed device.

### In the WebUI

1. In a **Managed Device** node hierarchy, navigate to **Configuration** > **Services** page and select the **IP Mobility** tab.
2. Click **Mobility Domain** accordion. Select a Domain Name from the **IP Mobility Configuration** table.
3. Select **Enabled** for the **Active** drop-down list.
4. Click **Submit**.
5. Click **Pending Changes**.
6. In the **Pending Changes** window, select the check box and click **Deploy changes**.

### In the CLI

Use the following command to activate a mobility domain:

```
(host) [md] (config)#ip mobile active-domain <name>
```

To view the active domains in the CLI, use the **show ip mobile active-domains** command on the managed device.

## Tracking Mobile Users

This section describes how you can view information about the status of mobile clients in the mobility domain.

Location-related information for users, such as roaming status, AP name, ESSID, BSSID, and physical type are consistent in both the home agent and foreign agent. The username, role, and authentication can be different on the home agent and foreign agent, as explained by the following:

L2 GRE tunnels are automatically established between managed devices in mobility domain at the time of boot up. Whenever a client connects to a managed device in a mobility domain, layer-2 authentication is performed and the station obtains the layer-2 (logon) role. When the client roams to other networks, layer-2 authentication is performed and the client obtains the layer-2 role. If layer-3 authentication is required, this authentication is performed on the client’s home agent only. The home agent obtains a new role for the client after layer-3 authentication; this new role appears in the user status on the home agent only. Even if reauthentication occurs after the station moves to a foreign agent, the display on the foreign agent still shows the layer-2 role for the user.

## Mobile Client Roaming Status

You can view the list of mobile clients and their roaming status on any managed device in the mobility domain:

## In the CLI

```
(host) [md] #show ip mobile host
```

Roaming status can be one of the following:

**Table 124:** *Client Roaming Status*

Roaming Status Type	Description
Home Switch/Home VLAN	This managed device is the home agent for a station, and the client is on the VLAN on which it has an IP address.
Mobile IP Visitor	This managed device is not the home agent for a client.
Mobile IP Binding (away)	This managed device is the home agent for a client that is currently away.
Home Switch/Foreign VLAN	This managed device is the home agent for a client, but the client is currently on a different VLAN than its home VLAN (the VLAN from which it acquired its IP address).
Stale	The client does not have connectivity in the mobility domain. Either the managed device has received a disassociation message for a client, but has not received an association or registration request for the client from another managed device, or a home agent binding for the station has expired before being refreshed by a foreign agent.
No Mobility Service	The managed device cannot provide mobility service to this client. The mobile client may lose its IP address if it obtains the address via DHCP and has limited connectivity. The mobile client may be using an IP address that cannot be served, or there may be a roaming hole due to improper configuration.

## Viewing User Roaming Status using the CLI

You can view the roaming status of users on any managed device in the mobility domain:

```
(host) [md] #show user
```

Roaming status can be one of the following:

**Table 125:** *User Roaming status*

Status Type	Description
Wireless	This client is on its home agent managed device and the client is on the VLAN on which it has an IP address.
Visitor	This client is visiting this managed device and the managed device is not its home agent.
Away	This client is currently away from its home agent managed device.

Status Type	Description
Foreign VLAN	This client is on its home agent managed device but the client is currently on a different VLAN than the one on which it has an IP address.
Stale	This should be a temporary state as the client will either recover connectivity or the client's entry is deleted when the stale timer expires.

### In the CLI

```
#show ip mobile trace <ip-address>|<mac-address>
```

## Mobile Client Roaming Locations

You can view information about where a mobile user has been in the mobility domain. This information can only be viewed on the client's home agent using the following command:

```
(host) [md] #show ip mobile trail <ip-address>|<mac-address>
```

## HA Discovery on Association

In normal circumstances, a managed device performs an HA discovery only when it is aware of the client's IP address which it learns through the ARP or any L3 packet from the client. This limitation of learning the client's IP and then performing the HA discovery is not effective when the client performs an inter switch move silently (does not send any data packet when in power save mode). This behavior is commonly seen with various handheld devices, Wi-Fi phones and so on. This delays HA discovery and eventually results in any loss of downstream traffic that is meant for the mobile client.

When HA discovery on association is triggered, the foreign agent managed device to which the client is associated, sends a unicast request to all managed device within the mobility domain to find if any one of the managed device has the IP mobility state information of the client.

With HA discovery on association, a managed device can perform a HA discovery as soon as the client is associated. This feature is enabled by default. This option will also poll for all potential HAs.

### In the CLI

To configure the mobility association:

```
(host) [md] (config)#wlan virtual-ap default ha-disc-onassoc
```

## Configuring Advanced Mobility Functions

You can configure various parameters that pertain to mobility functions on a managed device in a mobility domain using either the WebUI or the CLI.

### In the WebUI

1. In a **Managed Device** node hierarchy, navigate to **Configuration > Services** and select the **IP Mobility** tab.
2. Click **Global Parameters** accordion and configure the IP mobility settings.



**Table 126: IP Mobility - Global Parameters**

Parameter	Description
<b>General</b>	
Encapsulation supported	This parameter shows the type of encapsulation currently supported on the Managed device.
Clear mobility counters	Clear counters for IP mobility statistics.
Clear trail entries	Clear the station location trail table. You can view entries in this table using the <code>show ip mobile trail</code> command.
<b>Foreign Agent</b>	
Lifetime	Requested lifetime, in seconds, as per RFC 3344, IP Mobility Support for IPv4. Range: 10-65534 seconds Default: 180 seconds
Max. visitors allowed	Set a maximum allowed number of active visitors. Range: 0-5000 visitors Default: 5000 visitors
Registration requests retransmits	Maximum number of times the foreign agent attempts mobile IP registration message exchanges before giving up. Range: 0-5 attempts Default: 3 attempts
Registration requests interval	Retransmission interval, in milliseconds. Range: 100-10000 milliseconds Default: 1000 milliseconds
<b>Home Agent</b>	
Replay	Time difference, in seconds, for timestamp-based replay protection, as described by RFC 3344, IP Mobility Support for IPv4. 0 disables replay. Range: 0-5000 seconds Default: 5000 seconds.
Max. binding allowed	Maximum number of mobile IP bindings. Note that there is a license-based limit on the number of users and a one user per binding limit in addition to unrelated users. This option is an additional limitation to control the maximum number of roaming users. When the limit is reached, registration requests from the foreign agent fail which causes a mobile client to set a new session on the visited managed device, which will become its home managed device.

Parameter	Description
	<p>Range: 0-300 seconds</p> <p>Default: 7 seconds</p>
<b>Proxy Mobile IP</b>	
Mobility trail logging	Enables logging at the notification level for mobile client moves.
Mobility host entry lifetime	Time, in seconds, after which mobility service expires. If nothing has changed from the previous state, the client is given another bridge entry but it will have limited connectivity.
Max. station mobility events per second	<p>Maximum number of mobility events (events that can trigger mobility) handled per second. Mobility events above this threshold are ignored. This helps to control frequent mobility state changes when the client bounces back and forth on APs before settling down.</p> <p>Range: 1-65535 events</p> <p>Default: 25 events</p>
Station trail timeout	<p>Specifies the maximum interval, in seconds, an inactive mobility trail is held.</p> <p>Range: 120-86400 seconds</p> <p>Default: 3600 seconds</p>
Station trail max. entries	<p>Specifies the maximum number of entries (client moves) stored in the user mobility trail.</p> <p>Range: 1-100 entries</p> <p>Default: 30 entries.</p>
Mobility host entry hold time	Number of seconds the mobility state is retained after the loss of connectivity. This allows authentication state and mobility information to be preserved on the home agent managed device. The default is 60 seconds but can be safely increased. In many case a station state is deleted without waiting for the stale timeout; user delete from management, foreign agent to foreign agent handoff, and so on. (This is different from the no-service-timeout; no-service-timeout occurs up front, while the stale-timeout begins when mobility service is provided but the connection is disrupted for some reason.)
<b>Revocation</b>	
Retransmits	<p>Maximum number of times the home agent or foreign agent attempts mobile IP registration/revocation message exchanges before giving up.</p> <p>Range: 0-5 retransmissions</p> <p>Default: 3 retransmissions.</p>
Interval	<p>Retransmission interval, in milliseconds.</p> <p>Range: 100-10000 milliseconds</p> <p>Default: 1000 milliseconds</p>

3. Click **Submit**.
4. Click **Pending Changes**.
5. In the **Pending Changes** window, select the check box and click **Deploy changes**.

## In the CLI

To configure foreign agent functionality, use the following command:

```
(host) [md] (config)#ip mobile foreign-agent {lifetime <seconds> | max-visitors <number> | registrations {interval <msecs> | retransmits <number>}}
```

To configure home agent functionality, use the following command:

```
(host) [md] (config)#ip mobile home-agent {max-bindings <number>|replay <seconds>}
```

To configure proxy mobile IP and DHCP functionality, use the following command:

```
(host) [md] (config)#ip mobile proxy auth-sta-roam-only | block-dhcp-release | event-threshold <number> | log-trail | no-service-timeout <seconds> | on-association | refresh-stale-ip | stale-timeout <seconds> | stand-alone-AP | trail-length <number> |trail-timeout <seconds>
```

To configure revocation functionality, use the following command:

```
(host) [md] (config)#ip mobile revocation {interval <msec>|retransmits <number>}
```

To enable packet trace for a given MAC address, use the following command:

```
(host) [md] (config)#ip mobile packet-trace <host MAC address>
```

## Proxy Mobile IP

The *proxy mobile IP module* in a mobility-enabled managed device detects when a mobile client has moved to a foreign network and determines the home agent for a roaming client. The proxy mobile IP module performs the following functions:

- Derives the address of the home agent for a mobile client from the HAT using the mobile client's IP address. If there is more than one possible home agent for a mobile client in the HAT, the proxy mobile IP module uses a discovery mechanism to find the current home agent for the client.
- Detects when a mobile client has moved. Client moves are detected based on ingress port and VLAN changes, and mobility is triggered accordingly. For faster roaming convergence between AP(s) on the same managed device, it is recommended that you keep the **on-association** option enabled. This helps trigger mobility as soon as 802.11 association packets are received from the mobile client.

## Revocations

A home agent or foreign agent can send a registration revocation message, which revokes registration service for the mobile client. For example, when a mobile client roams from one foreign agent to another, the home agent can send a registration revocation message to the first foreign agent so that the foreign agent can free any resources held for the client.

## IPv6 L3 Mobility

ArubaOS supports IPv6 L3 Mobility functionality. The existing L3 mobility solution has been enhanced to support dual stacked (IPv4 and IPv6) and pure IPv6 mobile clients. The IPv6 L3 mobility allows the wireless clients to retain their IPv4 or IPv6 addresses across different VLANs within a managed device and between different managed devices. In the previous release, the Aruba Managed devices supported L3 mobility only for single stacked IPv4 clients.

The following changes in the existing behavior is observed in the Aruba managed device when you enable IPv6 L3 Mobility support :

- The managed device throttles and proxies Router Advertisements (RAs) if the router mobile command is enabled.

The following command configures the maximum time allowed between sending unsolicited multicast router advertisements from each interface when RA proxy is enabled:

```
(host) [mynode] (config)# ipv6 proxy-ra interval <180-1800>
```

The default value for `proxy-ra interval` is 600 seconds. If RA is configured on an external router, but not within the managed device, the managed device stores the RA in cache and replays the RA from the external server and replays them every `proxy-ra interval`. If RA is configured in both an external router and in the managed device, clients serviced by the managed device receive RA only from the managed device and not from the external router.

- L3 mobility support for wired and third-party APs are deprecated.
- The HA discovery on association parameter is turned on by default and is not configurable.



NOTE

---

By enabling L3 mobility feature, both the solicited RAs and the unsolicited periodic RAs will be converted to L2 unicast and sent to the wireless clients.

---



NOTE

---

It is recommended to reboot the managed device when you issue the **no router mobile** command so that mutlicast RAs do not continue to get converted to unicast RAs.

---

## Multicast Mobility

Multicast mobility ensures a client gets an uninterrupted multicast stream while roaming. ArubaOS provides support for a MLD proxy to enable IPv6 multicast mobility. To achieve multicast mobility, the Home Agent (HA) and the Foreign Agent (FA) must be capable of MLD proxying by exchanging the MLD membership information and process MLD messages. ArubaOS managed device supports MLD versions v1 and v2.

## Important Points to Remember

- ArubaOS does not support the source-based forwarding functionality of MLDv2.
- The multicast traffic flow stops for few seconds for roaming clients after enabling or disabling the Dynamic Multicast Optimization (DMO) option.

## In the CLI

Use the following command to enable MLD proxy in the VLAN:

```
(host) [md] (config)# interface vlan <vlan-id>
(host) [md] (config-subif)# ipv6 mld proxy <gigabitethernet/fastethernet> <slot/module/port>
```

Use the following command to display the interface-specific MLD proxy group information:

```
(host) [md] #show ipv6 mld proxy-group
```

Use the following command to display the MLD proxy mobility database group information for tracking:

```
(host) [md] #show ipv6 mld proxy-mobility-group
```

Use the following command to display the statistics of the MLD proxy:

```
(host) [md] #show ipv6 mld proxy-stats
```

Use the following command to display the MLD proxy mobility multicast statistics:

```
(host) [md] # show ipv6 mld proxy-mobility-stats
```

The following command displays the discovery count table that keeps track of per client home agent discovery:

```
(host) [md] #show datapath mobility discovery-table
```

The following command displays the datapath HA table information:

```
(host) [md] #show datapath mobility home-agent-table
```

The following command displays the mobility multicast-group table that floods the multicast RA traffic to the roaming clients:

```
(host) [md] #show datapath mobility mcast-table
```

The following commands displays the statistics of the datapath mobility:

```
(host) [md] #show datapath mobility stats
```

The following command displays the mobility multicast VLAN table information:

```
(host) [md] #show ip mobile multicast-vlan-table
```

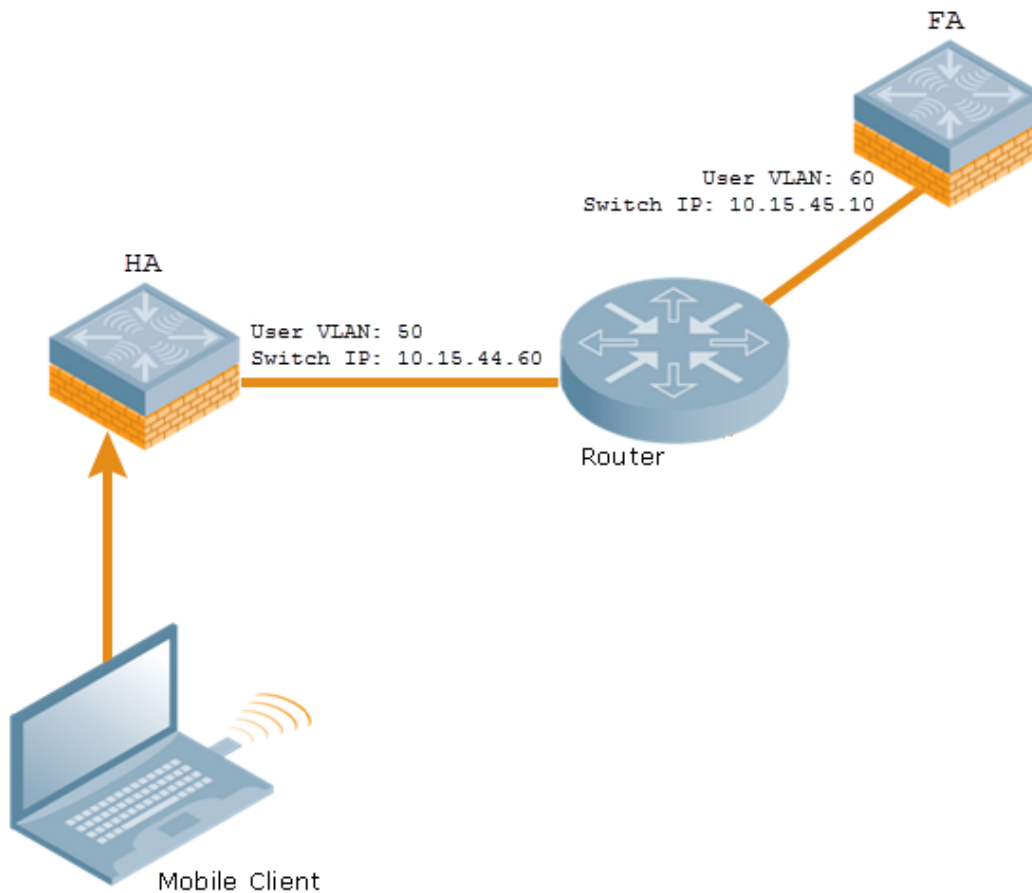
The outputs of the following commands are enhanced to support IPv6 L3 mobility:

- `show ip mobile host`
- `show ip mobile trace`
- `show ip mobile remote`
- `show ip mobile binding`
- `show ip mobile visitor`
- `show ip mobile trail`
- `show ip mobile packet-trace`
- `clear ip mobile trail <IPv6_addr>`
- `show ip mobile traffic`
- `show ip mobile global`
- `show ip mobile hat`
- `show ip mobile domain`
- `ip mobile domain <name> hat <home-agent> description <dscr>`

### Sample Configuration

The following figure provides information on how a client moves from one managed device to another, when you enable IPv6 L3 mobility feature:

**Figure 45** Sample IPv6 L3 Mobility Configuration



The following commands displays the initial configuration on HA and FA:

```
(host-HA) #show ip mobile domain
Mobility Domains:, 2 domain(s)
-----
Domain name default
Home Agent Table
Domain name 6.3mobility
Home Agent Table
Home Agent Description
-----
10.15.45.10
10.15.44.60
(host-FA) #show ip mobile domain
Mobility Domains:, 2 domain(s)
-----
Domain name default
Home Agent Table
Domain name 6.3mobility
Home Agent Table
Home Agent Description
-----
10.15.45.10
10.15.44.60
```

The following commands displays information on the client association to HA:

```
(host-HA) #show user
Users
-----
IP MAC Name Role Age(d:h:m) Auth VPN l
ink AP name Roaming Essid/Bssid/Phy Profile Forward mode
Type Host Name
-----
-----
-----
50.50.50.11 24:77:03:9e:dc:4c authenticated 00:00:00
AP124-B11550-Jibin Wireless mobility-test/00:1a:1e:82:b3:10/a-HT default tunnel
2001:5000::2677:3ff:fe9e:dc4c 24:77:03:9e:dc:4c authenticated 00:00:00
AP124-B11550-Jibin Wireless mobility-test/00:1a:1e:82:b3:10/a-HT default tunnel
fe80::2677:3ff:fe9e:dc4c 24:77:03:9e:dc:4c authenticated 00:00:00
AP124-B11550-Jibin Wireless mobility-test/00:1a:1e:82:b3:10/a-HT default tunnel
```

```
(host-HA) #show ip mobile host
Mobile Host List, 1 host(s)
-----
24:77:03:9e:dc:4c
IPv4: 50.50.50.11
IPv6: fe80::2677:3ff:fe9e:dc4c, 2001:5000::2677:3ff:fe9e:dc4c
Roaming Status: Home Switch/Home VLAN, Service time 0 days 00:00:57
Home VLAN 50
```

```
(host-HA) #show datapath bridge table 24:77:03:9e:dc:4c
Datapath Bridge Table Entries
-----
Flags: P - Permanent, D - Deny, R - Roamed Client, M - Mobile, X - Xsec, A - Auth, O - Outer V
LAN, T - Trusted
MAC VLAN Assigned VLAN QinQ VLAN Destination Flags
-----
24:77:03:9E:DC:4C 50 50 0 tunnel 17 PM
```

```
(host-HA) #show datapath station
Datapath Station Table Entries
-----
Flags: W - WEP, T - TKIP, A - AESCCM, M - WMM N - .11n client
S - AMSDU, G - AESGCM, R - DATA READY, I - INACTIVE, r - ROAMED
MAC BSSID VLAN Bad Decrypts Bad Encrypts Cpu Qsz RSN cap Aid HomeVlan
Flags
-----
-----
24:77:03:9E:DC:4C 00:1A:1E:82:B3:10 50 0 0 8 0 0 0 0 0000 0001
50 MN
```

The following commands displays status of the client roaming to FA:

```
(host-FA) #show ap association
Association Table
-----
Name bssid mac auth assoc aid l-int essid vlan-i
d tunnel-id phy assoc. time num assoc Flags Band steer moves (T/S)
-----
-----
Ap_local 6c:f3:7f:3a:ba:d8 24:77:03:9e:dc:4c y y 1 100 mobility-test 60
0x1000f a-HT-40sgi-2ss 3m:20s 1 WA 0/0
ArubaOS 6.4 | User Guide IP Mobility | 594
595 | IP Mobility ArubaOS 6.4 | User Guide
Num Clients:1
```

```

(host-FA) #show user
Users
-----
IP MAC Name Role Age(d:h:m) Aut
h VPN link AP name Roaming Essid/Bssid/Phy Profile Forward mode T
ype Host Name
-----
-----
---- --
50.50.50.11 24:77:03:9e:dc:4c sys_mip_role_649130_9 00:00:03
Ap_local Visitor mobility-test/6c:f3:7f:3a:ba:d8/a-HT default tunnel
Win 7
2001:5000::2677:3ff:fe9e:dc4c 24:77:03:9e:dc:4c sys_mip_role_649130_9 00:00:03
Ap_local Visitor mobility-test/6c:f3:7f:3a:ba:d8/a-HT default tunnel
Win 7
User Entries: 2/2
Curr/Cum Alloc:1/7 Free:1/6 Dyn:2 AllocErr:0 FreeErr:0
(host-FA) #show ip mobile host
Mobile Host List, 1 host(s)
-----
24:77:03:9e:dc:4c
IPv4: 50.50.50.11
IPv6: 2001:5000::2677:3ff:fe9e:dc4c
Roaming Status: Mobile IP Visitor, Service time 0 days 00:03:33
Home VLAN 50, visiting local VLAN 60

(host-FA) #show datapath bridge table 24:77:03:9e:dc:4c
Datapath Bridge Table Entries
-----
Flags: P - Permanent, D - Deny, R - Roamed Client, M - Mobile, X - Xsec, A - Auth, O - Outer V
LAN, T - Trusted
MAC VLAN Assigned VLAN QinQ VLAN Destination Flags
-----
24:77:03:9E:DC:4C 4095 60 0 tunnel 15 PMR
24:77:03:9E:DC:4C 60 60 0 tunnel 15 PM

(host-FA) #show datapath station
Datapath Station Table Entries
-----
Flags: W - WEP, T - TKIP, A - AESCCM, M - WMM N - .11n client
S - AMSDU, G - AESGCM, R - DATA READY, I - INACTIVE, r - ROAMED
MAC BSSID VLAN Bad Decrypts Bad Encrypts Cpu Qsz RSN cap Aid HomeVlan
Flags
-----
-----
24:77:03:9E:DC:4C 6C:F3:7F:3A:BA:D8 60 0 0 7 0 0 0 0 0000 0001
50 MNr

(host-FA) #show ip mobile visitor
Foreign Agent Visitor list, 1 host(s)
-----
24:77:03:9e:dc:4c
IPv4: 50.50.50.11
IPv6: 2001:5000::2677:3ff:fe9e:dc4c
HA Addr 10.15.44.60, Registration id D51BA8BC:856865FC
Lifetime granted 00:00:40 (40), remaining 00:00:36
Tunnel id 9, src 10.15.44.10 dest 10.15.44.60, reverse-allowed

```

The following command displays the status of the client on HA after roaming:



```

(host-HA) #show user
Users
-----
IP MAC Name Role Age(d:h:m) Auth VPN l
ink AP name Roaming Essid/Bssid/Phy Profile Forward mode Type Hos
t Name
-----
-----
50.50.50.11 24:77:03:9e:dc:4c authenticated 00:00:08
Ap_local Away mobility-test/6c:f3:7f:3a:ba:d8/a-HT default tunnel
2001:5000::2677:3ff:fe9e:dc4c 24:77:03:9e:dc:4c authenticated 00:00:08
Ap_local Away mobility-test/6c:f3:7f:3a:ba:d8/a-HT default tunnel
User Entries: 2/2
Curr/Cum Alloc:1/16 Free:1/15 Dyn:2 AllocErr:0 FreeErr:0

(host-HA) #show ip mobile host
Mobile Host List, 1 host(s)
-----
24:77:03:9e:dc:4c
IPv4: 50.50.50.11
IPv6: 2001:5000::2677:3ff:fe9e:dc4c
Roaming Status: Mobile IP Binding (Away), Service time 0 days 00:08:20
Home VLAN 50

(host-HA) #show datapath bridge table 24:77:03:9e:dc:4c
Datapath Bridge Table Entries
-----
Flags: P - Permanent, D - Deny, R - Roamed Client, M - Mobile, X - Xsec, A - Auth, O - Outer V
LAN, T - Trusted
MAC VLAN Assigned VLAN QinQ VLAN Destination Flags
-----
24:77:03:9E:DC:4C 4095 50 0 tunnel 9 PMT
24:77:03:9E:DC:4C 50 50 0 tunnel 9 PMTR

(host-HA) #show ip mobile binding
Home Agent Binding list, 1 host(s)
-----
24:77:03:9e:dc:4c
IPv6: 2001:5000::2677:3ff:fe9e:dc4c
FA Care-of Addr 10.15.44.10, Src Addr 10.15.44.10, HAT HA Addr 10.15.44.60
FA Visiting VLAN 60
Lifetime granted 00:00:40 (40), remaining 00:00:23
Flags T, Registration id D51BA8BC:856865FC
Tunnel id 9, src 10.15.44.60 dest 10.15.44.10, reverse-allowed

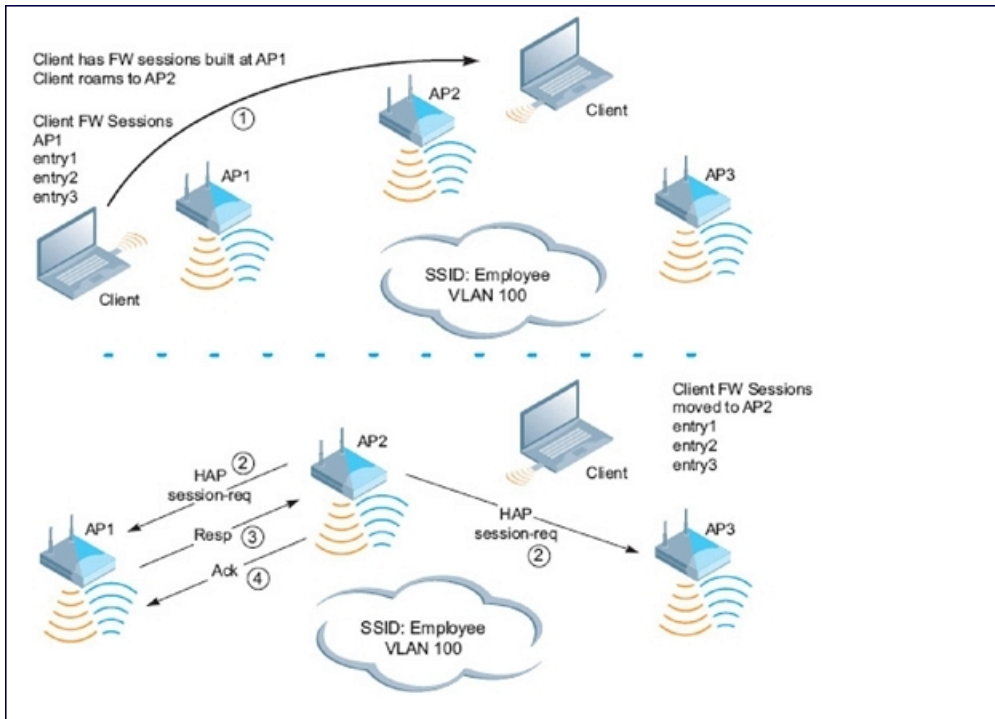
```

## Understanding Bridge Mode Mobility Deployments

In bridge mode deployments, it is possible to deploy more than one AP in a single location. Therefore, APs in bridge forwarding mode support firewall session synchronization, which allows clients to retain their current session and IP address as they roam between different bridge mode APs on the same layer-2 network.

The bridge mode mobility feature facilitates client mobility on up to 32 layer-2 connected APs by allowing the APs to communicate and share the user state as the user roams from AP to AP. This mechanism is always enabled when an AP is set to bridge mode, and it requires that all APs be on the same Layer 2 segment where roaming will occur.

**Figure 46** Bridge Mode Mobility



The roaming process occurs as follows:

1. A client begins to roam from AP1 and starts an association with AP2.
2. AP2 sends a broadcast message to all APs on the local layer-2 network, asking if any other AP has a current session state for the roaming client.
3. Only AP1 responds to the broadcast, and sends the current session table of the client.
4. AP2 acknowledges receipt of the session table.
5. AP1 deletes the session state of the client.
6. Roaming is complete.

## Monitoring Network Traffic Using IPFIX

IP Flow Information Export (IPFIX) allows clients to easily monitor network traffic to and from the node. This information is cached on the managed device, then exported to an assigned collector server within the node once the table is full or the timer has expired. This information is then logged and stored by the collector server for viewing.

### Enabling IPFIX

Before enabling IPFIX, the device must be configured for local management within the node. If the device is not locally managed, the IPFIX tab will not display in the WebUI.

#### In the WebUI

1. In a **Managed Device** node hierarchy, navigate to **Configuration > Services** and select the **External Services** tab.
2. Click **IPFIX** accordion.
3. Select **Enabled** from the **Enable IPFIX** drop-down list.
4. Click **Submit**.

5. Click **Pending Changes**.
6. In the **Pending Changes** window, select the check box and click **Deploy changes**.

### In the CLI

```
(host) [md] (config)#ip-flow-export-profile
(host) [md] (ip flow collector profile)#enable
```

## Enabling Wireless Export

Starting with ArubaOS 8.0.1.0, IPFIX supports wireless export. When wireless export is enabled, a new template is defined to gather and export information about wireless clients, in addition to the standard attributes exported through the existing, pre-defined template.

The wireless attributes include:

- Station MAC
- Station IP
- Station SSID
- AP MAC



---

If wireless export is enabled, data flows become unidirectional.

---

### In the CLI

```
(host) [mynode] (config) #ip-flow-export-profile
(host) [mynode] (ip flow collector profile) #wireless-export
```

## Assigning the Collector Device

When a device belonging to a node exports a cache, it is sent to the designated Collector Device in that node. The Collector Device receives, logs and stores the data from the other devices in the node.

### In the WebUI

1. In a **Managed Device** node hierarchy, navigate to **Configuration > Services** and select the **External Services** tab.
2. Click **IPFIX** accordion.
3. Select **Enabled** from the **Enable IPFIX** drop-down list.
4. Enter the IP address of the device in the **Collector IP address** field.
5. Click **Submit**.
6. Click **Pending Changes**.
7. In the **Pending Changes** window, select the check box and click **Deploy changes**.

### In the CLI

```
(host) [md] (config)#ip-flow-export-profile
(host) [md] (ip flow collector profile)#collector-ip <collector ip address>
```

## Selecting a Transfer Mode

IPFIX supports UDP and TCP transfer protocols when sending a cache from a device to the Collector Device.

## In the WebUI

1. In a **Managed Device** node hierarchy, navigate to **Configuration > Services** and select the **External Services** tab.
2. Click **IPFIX** accordion.
3. Select **Enabled** from the **Enable IPFIX** drop-down list.
4. Select a transfer protocol from the **Transport mode** drop-down list.
5. Click **Submit**.
6. Click **Pending Changes**.
7. In the **Pending Changes** window, select the check box and click **Deploy changes**.

## In the CLI

```
(host) [md] (config)#ip-flow-export-profile
(host) [md] (ip flow collector profile)# transport-protocol<protocol>
```

## Assigning a Destination Port

Clients can assign a destination port on the Collector Device to direct incoming data caches from other devices in the node.

## In the WebUI

1. In a **Managed Device** node hierarchy, navigate to **Configuration > Services** and select the **External Services** tab.
2. Click **IPFIX** accordion.
3. Select **Enabled** from the **Enable IPFIX** drop-down list.
4. Enter the port number into the **Port** field.
5. Click **Submit**.
6. Click **Pending Changes**.
7. In the **Pending Changes** window, select the check box and click **Deploy changes**.

## In the CLI

```
(host) [md] (config)#ip-flow-export-profile
(host) [md] (ip flow collector profile)#port <port number>
```

## Modifying the Flow Cache Size and Interval Settings

The Flow Cache limits when the cache is exported to the Collector Device and can be determined by the size of the cache or the duration of time in the session. When any one of these values is met, the cache is exported and a new one begins.

- **Flow cache size:** The maximum number of entries in a cache before it is exported.
- **Upload interval (all):** The interval (time in minutes) to export active sessions.
- **Upload interval (inactive):** The interval (time in minutes) to export inactive flows.
- **Upload interval template:** The interval (time in minutes) to export templates.

## In the WebUI

1. In a **Managed Device** node hierarchy, navigate to **Configuration > Services** and select the **External Services** tab.
2. Click **IPFIX** accordion.
3. Select **Enabled** from the **Enable IPFIX** drop-down list.

4. Enter the maximum number of entries in the **Flow cache size** field.
5. Enter the time interval for an active session in the **Upload interval (all)** field.
6. Enter the time interval for an inactive session in the **Upload interval (inactive)** field.
7. Enter the time interval to export templates in the **Upload interval template** field.
8. Click **Submit**.
9. Click **Pending Changes**.
10. In the **Pending Changes** window, select the check box and click **Deploy changes**.

### In the CLI

The following CLI commands can be used to adjust the Flow cache size and interval export settings.

```
(host) [md] (config)#ip-flow-export-profile
(host) [md] (ip flow collector profile)#flow-cache-size<interger>
(host) [md] (ip flow collector profile)#upload-all-interval<interger>
(host) [md] (ip flow collector profile)#upload-inactive-interval<interger>
(host) [md] (ip flow collector profile)#upload-template-interval<interger>
```

## Selecting the Observation Domain

The Observation Domain is a value used by the Collector Device to group devices when receiving data sessions.

### In the WebUI

1. In a **Managed Device** node hierarchy, navigate to **Configuration > Services** and select the **External Services** tab.
2. Click **IPFIX** accordion.
3. Select **Enabled** from the **Enable IPFIX** drop-down list.
4. Enter the value in the **Observation Domain** field.
5. Click **Submit**.
6. Click **Pending Changes**.
7. In the **Pending Changes** window, select the check box and click **Deploy changes**.

### In the CLI

```
(host) [md] (config)#ip-flow-export-profile
(host) [md] (ip flow collector profile)#observation-domain
```

## Enabling Mobility Multicast

Internet Protocol (IP) multicast is a network addressing method used to simultaneously deliver a single stream of information from one sender to multiple clients on a network. Unlike broadcast traffic, which is meant for all hosts in a single domain, multicast traffic is sent only to those specific hosts who are configured to receive such traffic. Clients who want to receive multicast traffic can join a multicast group via IGMP messages. Upstream routers use IGMP message information to compute multicast routing tables and determine the outgoing interfaces for each multicast group stream.

When a mobile client moved away from its local network and associated with a VLAN on a foreign managed device (or a foreign VLAN on its own managed device), the client's multicast membership information would not be available at its new destination, and multicast traffic from the client could be interrupted. However, ArubaOS supports mobility multicast enhancements that provide uninterrupted streaming of multicast traffic, regardless of a client's location.

## Working with Proxy IGMP and Proxy Remote Subscription

The managed device is always aware of the client's location, so the managed device can join multicast group(s) on behalf of that mobile client. This feature, called Proxy IGMP, allows the managed device to join a multicast group and suppresses the client's IGMP control messages to the upstream multicast router. (The client's IGMP control messages will, however, still be used by managed device to maintain a multicast forwarding table.) The multicast IGMP traffic originating from the client will instead be sent from the managed device's incoming VLAN interface IP.

The IGMP proxy feature includes both a host implementation and a router implementation. An upstream router sees a managed device running IGMP proxy as a host; a client attached to the managed device sees the managed device as router. When you enable Proxy IGMP, all multicast clients associated with the managed device are hidden from the upstream multicast device or router.



---

The newer IGMP proxy feature and the older IGMP snooping feature cannot be enabled at the same time, as both features add membership information to multicast group table. For most multicast deployments, you should enable the IGMP Proxy feature on all VLAN interfaces to manage all the multicast membership requirements on the managed device. If IGMP snooping is configured on some interfaces, there is a greater chance that multicast information transfers may be interrupted.

---

IGMP proxy must be enabled or disabled on each individual interface. To use the IGMP proxy, ensure that the VLANs on the managed device are extended to the upstream router. Enabling IGMP proxy enables IGMP on the interface and sets the querier to the managed device itself. You must identify the managed device port from which the managed device sends proxy join information to the upstream router, and identify the upstream router by upstream port so the managed device can dynamically update the upstream multicast router information.

### IGMPv3 Support

ArubaOS supports IGMPv3 functionality that makes Aruba managed devices aware of the Source Specific Multicast (SSM) and is used to optimize bandwidth of the network. The SSM functionality is an extension of IP multicast where the datagram traffic is forwarded to receivers from only those multicast sources to which the receivers have explicitly joined. By default, the multicast group range of 232.0.0.0 through 232.255.255.255 (232/8) is reserved for SSM by IANA (Internet Assigned Numbers Authority).

The IGMPv3 snooping functionality is configured at the edge of the network. The devices that support IGMP snooping listen for the IGMP messages that the host sent to join an IP multicast group. These devices record details of all the hosts and also about the IP multicast group in which a particular host has joined. These devices forward IP multicast traffic to the hosts that have joined the specific multicast group.



---

The IGMP proxy and IGMP snooping functionalities cannot be enabled on the same VLAN simultaneously.

---

### Configuring SSM Range

You can configure the SSM range by using the CLI and WebUI.

#### In the WebUI

1. In a **Managed Device** node hierarchy, navigate to the **Configuration > Interfaces** page and select the **Multicast** tab.
2. In the **IGMP** accordion, enter values for SSM Range in the **SSM range start-ip** and **SSM range mask-ip** fields.
3. Click **Submit**.
4. Click **Pending Changes**.

5. In the **Pending Changes** window, select the check box and click **Deploy changes**.



The proxy operation will be downgraded to IGMPv2 if any lower version clients are present and reverts back to v3 mode if the managed device finds no lower version client joins (reports) for a specified interval of time. In the downgraded proxy operation the SSM semantics is not applicable for the particular VLAN.

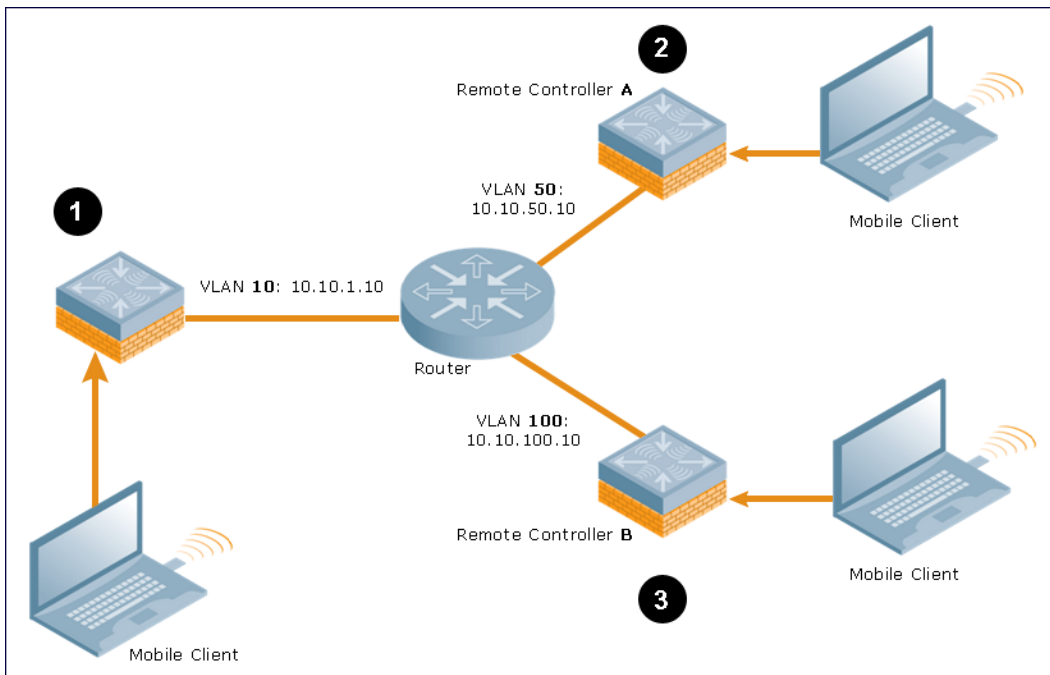
### In the CLI

```
(host) [md] (config) # ip igmp
(host) [md] (config-ip) # ssm-range <startip> <maskip>
```

## Working with Inter managed device Mobility

When a client moves from one managed device to another, multicast traffic migrates as follows:

**Figure 47** *Inter-managed device Mobility*



1. The managed device uses its VLAN 10 IP address to join multicast group 1 on behalf of a mobile client.
2. The mobile client leaves its managed device and roams to VLAN 50 remote managed device A. Remote managed device A locates the mobile client's managed device and learns about the client's multicast groups. Remote managed device A then joins group 1 on behalf the mobile client, using its VLAN 50 source IP. Upstream multicast traffic from the roaming client is sent to the managed device over an L2 GRE tunnel. The remote managed device will receive downstream multicast traffic and send it to the mobile client.



The L2-GRE Tunnel implementation of the IP mobility functionality is supported only on ArubaOS versions 6.2 or later, and is not backward compatible with the earlier implementation. ArubaOS supports only v4 mobility and does not support IPv6 L3 mobility.

Meanwhile, the managed device checks to see if other local clients require group 1 traffic. If no other clients are interested in group 1, then the managed device will leave that group. If there are other clients using that group, the managed device will continue its group 1 membership.

3. Now the mobile client leaves remote managed device A and roams to VLAN 100 on remote managed device B. Remote managed device B locates the mobile client's managed device and learns about the client's

multicast groups. Remote managed device B then joins group 1 on behalf the roaming mobile client 1, using its VLAN 100 IP address.

Both the managed device and remote managed device A will verify if any of their other clients require group 1 traffic. If none of their other clients require group 1, then that managed device will leave the group. (If the managed device leaves the group, it will also notify remote managed device A.) If either managed device has other clients using that group, that managed device will continue its group 1 membership.

## Configuring Mobility Multicast

To enable IGMP and/or IGMP snooping on this interface, or configure a VLAN interface for uninterrupted streaming of multicast traffic:

### In the WebUI

1. In a **Managed Device** node hierarchy, navigate to the **Configuration > Interfaces** page and select the **VLANs** tab.
2. Select the VLAN name from the **VLANs** table and the **VLANs > <VLAN name>** table is displayed.
3. Select a VLAN ID you want to configure mobility multicast.
4. Select **IPv4** tab and click **IGMP** accordion.
5. Select **Enabled** from the **Enable IGMP** drop-down list to enable the router to discover the presence of multicast listeners on directly-attached links
6. Select **Enabled** from the **Enable IGMP Snooping** drop-down list to save bandwidth and limit the sending of multicast frames to only those nodes that need to receive them.
7. Select **Enabled** from the **Enable IGMP Proxy** drop-down list
8. In the **Proxy Interface** field, select the **Interface Gigabitethernet** or **Port Channel** option and select the value from the drop-down list.
9. Click **Submit**.
10. Click **Pending Changes**.
11. In the **Pending Changes** window, select the check box and click **Deploy changes**.

### In the CLI

```
(host) [md] (config)#interface vlan <vlan>
(host) [md] (config-submode)#ip igmp proxy [{port-channel|gigabitethernet} <slot/module/port>]
|[snooping]
```

## Multicast Group Limit

The following table describes the maximum multicast group limit per managed device platform.



---

Maximum multicast group is the sum of IPv4 IGMP and IPv6 MLD groups.

---



**Table 127:** *Multicast Group Limits*

Platform	Multicast Group Limit
7005	128
7010	256
7024	256
7030	512
7200 Series	4096

In many deployment scenarios, an external firewall is situated between Aruba devices. This chapter describes the network ports that need to be configured on the external firewall to allow proper operation of the Aruba network. You can also use this information to configure session ACLs to apply to physical ports on the managed device for enhanced security. However, this chapter does not describe requirements for allowing specific types of user traffic on the network.



---

A managed device uses both its loopback address and VLAN addresses for communications with other network elements. If the firewall uses host-specific ACLs, those ACLs must specify all IP addresses used on the managed device.

---

Topics in this chapter include:

- [Understanding Firewall Port Configuration Among Aruba Devices on page 626](#)
- [Enabling Network Access on page 627](#)
- [Ports Used for Virtual Intranet Access \(VIA\) on page 627](#)
- [Configuring Ports to Allow Other Traffic Types on page 627](#)

## Understanding Firewall Port Configuration Among Aruba Devices

This section describes the network ports that need to be configured on the firewall to allow proper operation of the network.

### Communication Between Managed Devices

Configure the following ports to enable communication between any two managed devices:

- IPsec (UDP ports 500 and 4500) and ESP (protocol 50). PAPI between Mobility Master and a managed device is encapsulated in IPsec.
- IP-IP (protocol 94) and UDP port 443 if Layer-3 mobility is enabled
- GRE (protocol 47) if tunneling guest traffic over GRE to DMZ managed device
- IKE (UDP 500)
- ESP (protocol 50)
- NAT-T (UDP 4500)

### Communication Between APs and the Managed Device

APs use Trivial File Transfer Protocol (TFTP) during their initial boot to grab their software image and configuration from the managed device. After the initial boot, the APs use FTP to retrieve their software images and configurations from the managed device. In many deployment scenarios, an external firewall is situated between various Aruba devices.

Configure the following ports to enable communication between an AP and the managed device:

- PAPI (UDP port 8211). If the AP uses DNS to discover the LMS managed device, the AP first attempts to connect to Mobility Master. (Also allow DNS (UDP port 53) traffic from the AP to the DNS server.)
- PAPI (UDP port 8211). All APs running as Air Monitors (AMs) require a permanent PAPI connection to Mobility Master.
- FTP (TCP port 21)

- TFTP (UDP port 69). All campus APs; If there is no local image on the AP or if the image needs to be upgraded (for example, a new AP), the AP will use TFTP to retrieve the initial image. For remote APs, upgrade the image only by FTP and not TFTP.
- SYSLOG (UDP port 514)
- PAPI (UDP port 8211)
- GRE (protocol 47)
- Control Plane Security (CPsec) uses UDP port 4500

### Communication Between Remote APs and the Managed Device

Configure the following ports to enable communication between a Remote AP (IPsec) and a managed device:

- NAT-T (UDP port 4500)
- TFTP (UDP port 69)




---

TFTP is not needed for normal operation. If the remote AP loses its local image for any reason, it will use TFTP to download the latest image.

---

## Enabling Network Access

This section describes the network ports that need to be configured on the firewall to manage the Aruba network.

For WebUI access between the network administrator's computer (running a web browser) and a managed device:

- HTTP (TCP ports 80 and 8888) or HTTPS (TCP ports 443 and 4343).
- SSH (TCP port 22) or TELNET (TCP port 23).

## Ports Used for Virtual Intranet Access (VIA)

The following ports are used with Aruba VIA.

- For the reachability/trusted network check, use port 443.
- For the IPsec connection, use port 4500.
- To allow ISAKMP, use port 500.
- To enable NAT-T, use port 4500.

## Configuring Ports to Allow Other Traffic Types

This section describes the network ports that need to be configured on the firewall to allow other types of traffic in the Aruba network. You should only allow traffic as needed from these ports.

- For logging: SYSLOG (UDP port 514) between the managed device and syslog servers.
- For software upgrade or retrieving system logs: TFTP (UDP port 69) or FTP (TCP ports 21 and 22) between the managed device and a software distribution server.
- If the managed device is a PPTP VPN server, allow PPTP (UDP port 1723) and GRE (protocol 47) to the managed device.
- If the managed device is an L2TP VPN server, allow NAT-T (UDP port 4500), ISAKMP (UDP port 500) and ESP (protocol 50) to the managed device.
- If a third-party network management system is used, allow SNMP (UDP ports 161 and 162) between the network management system and all managed devices.

- For authentication with a RADIUS server: RADIUS (typically, UDP ports 1812 and 1813, or 1645 and 1646) between the managed device and the RADIUS server.
- For authentication with an LDAP server: LDAP (UDP port 389) or LDAPS (UDP port 636) between the managed device and the LDAP server.
- For authentication with a Radsec Server—RADIUS over TLS): TCP port 443 between the managed device and the RADIUS/Radsec Proxy server.
- For authentication with a TACACS+ server: TACACS (TCP port 49) between the managed device and the TACACS+ server.
- For NTP clock setting: NTP (UDP port 123) between all managed devices and NTP server.
- For packet captures: UDP port 5555 from an AP to an Ethereal packet-capture station; UDP port 5000 from an AP to a Wildpackets packet-capture station.
- For telnet access: Telnet (TCP port 23) from the network administrator's computer to any AP, if **telnet enable** is present in the **ap location 0.0.0** section of the managed device configuration.
- For External Services Interface (ESI): ICMP (protocol 1) and syslog (UDP port 514) between a managed device and any ESI servers.
- For XML API: HTTP (TCP port 80) or HTTPS (TCP port 443) between a managed device and an XML-API client.

Starting from ArubaOS 8.0.1, a minor security enhancement is made to Process Application Programming Interface (PAPI) messages. With this enhancement, PAPI endpoints authenticate the sender by performing a sanity check of the incoming messages using MD5 (hash).

**All PAPI endpoints—access points, Mobility Access Switches, controllers, Analytics and Location Engine (ALE), Aruba Switches, HPE-ArubaOS Switch-based switches, AirWave, Mobility Master and Managed Devices—must use the same secret key.**



---

The same PAPI key must be configured for the Mobility Master and the managed device.

---

The PAPI Enhanced Security configuration provides protection to Aruba devices, AirWave, and ALE against malicious users sending fake messages that results in security challenges.



---

PAPI Enhanced Security does not solve all the PAPI security issues.

---

Topics in this chapter include:

- [Interoperability](#)
- [Configuring PAPI Enhanced Security](#)
- [Verifying PAPI Enhanced Security](#)

## Interoperability

The following list of references provides the Aruba devices interoperability information with respect to PAPI Enhanced security feature:

- For information on interoperability with AirWave, refer to the *AirWave 8.2.0.3 Release Notes*.
- For information on interoperability with Analytics and Location Engine (ALE), refer to the *Analytics and Location Engine 2.0.0.6 Release Notes*.
- For interoperability with Mobility Access Switches, refer to the *ArubaOS 7.4.1.5 Release Notes*.
- For interoperability with HPE-ArubaOSSwitch-based switches, refer to HP's *Management Configuration Guide 16.02*.

AirWave Management Platforms–AMP 8.0.11.2 and AMP 8.2.3–support PAPI Enhanced Security.

## Configuring PAPI Enhanced Security

You can configure the PAPI Enhanced Security feature by using the CLI.

### In the CLI

By default, the PAPI Enhanced Security configuration is disabled. If there is no configured key, the default key is used for authentication.

```
(host) [mynode] (config) #papi-security
(host) [mynode] (PAPI Security Profile) #?
enhanced-security Enable or disable the use of enhanced security mode
```

```

key                Key used to authenticate messages between systems.
Length must be between 10 and 64 characters. Use 'no key' to revert to the default key.
no                Delete Command
(host)[mynode] (PAPI Security Profile) #enhanced-security
(host)[mynode] (PAPI Security Profile) #write memory
Saving Configuration...
Partial configuration for /mm/mynode
-----
Contents of : /flash/config/partial/53/p=sc.cfg
papi-security
enhanced-security
!
Configuration Saved.

```

## Verifying PAPI Enhanced Security

To verify the status of the PAPI Enhanced Security configuration, execute the following command:

```

(host)[node] (config) #show papi-security
PAPI Security Profile
-----
Parameter                Value
-----
PAPI Key                  *****
Enhanced security mode Disabled

```

To view the statistics of transmitted, received, and denied messages, three additional output parameters are introduced in the **show ipc statistics** command output.

- Tx Sign—the number of messages which were signed before transmitting
- Rx Sign—the number of messages validated through digest validation
- Rx Denied—the number of messages denied due to incorrect digest

```

(host) [mynode] #show ipc statistics app-name sapm
Local Statistics
To application      Tx Msg   Tx Blk  Tx Ret  Tx Fail  Rx Ack  Rx Msg  Rx Drop
Layer2/3           4        0       0       0       0       0       2       0
Multicast DNS Lis  0        0       0       0       0       3       0
License Manager    2        2       0       0       2       2       0
Profile Manager    1        0       0       0       1       1       0
NEW_CLI_START      2        0       0       0       2       3       0
Authentication     0        0       0       0       0       1       0
Syslog Manager     4        4       0       0       4       0       0
Configuration Man  3        0       0       0       0       19      0
    Rx Err   Tx Ack   Tx Sign   Rx Sign   Rx Denied  Rx Silent  Drops
    0         0         0         0         0         0         0
    0         0         0         0         0         0         0
    0         0         0         0         0         0         0
    0         0         0         0         0         0         0
    0         0         0         0         0         0         0
    0         0         0         0         0         0         0
    0         0         0         0         0         0         0
Kernel PAPI Statistics
RxSockbufSize RxSockbufHimark CurRxQLen MaxRxQLen Drops
16777216      1152          0          1          0
Remote Device 10.4.176.95 Statistics
To application      Tx Msg   Tx Blk  Tx Ret  Tx Fail  Rx Ack  Rx Msg
SAPM              2565     0       0       0       0       2667
Rx Drop   Rx Err  Tx Ack  Tx Sign  Rx Sign  Rx Denied  Rx Silent  Drops
0         0       0       0       0       0         0         0

```

Remote Device 172.200.13.3 Statistics

To application	Tx Msg	Tx Blk	Tx Ret	Tx Fail	Rx Ack	Rx Msg
SAPM	2569	0	0	0	0	2569
Rx Drop	Rx Err	Tx Ack	<b>Tx Sign</b>	<b>Rx Sign</b>	<b>Rx Denied</b>	Rx Silent Drops
0	0	0	<b>0</b>	<b>0</b>	<b>0</b>	0
Allocated Buffers	4					
Static Buffers	0					
Static Buffer Size	1476					

The User-Identification (User-ID) feature of the Palo Alto Networks (PAN) firewall allows network administrators to configure and enforce firewall policies based on users and user groups. The User-ID identifies the user on the network based on the IP address of the device to which the user is logged in. Additionally, a firewall policy can be applied based on the type of device the user is using to connect to the network. Since the Mobility Master maintains the network and user information of clients in the network, it is the best source to provide information for the User-ID feature of the PAN firewall.



---

The procedures in this chapter describe the steps to integrate a Palo Alto Networks firewall with a Mobility Master or managed device. **For additional details on configuring PAN firewall integration, see [Managed Device Feature Overview on page 207](#)**

---

This feature introduces the following interactions with PAN firewall servers running PAN-OS 5.0 or later:

- Send login events for the client to the PAN firewall with its IP address, username, and device type, when classified.
- Send logout events for the client to PAN firewalls with its IP address.

The following must be configured on the PAN Firewall:

- An admin account must be created on the PAN firewall to allow the managed device to send data to the PAN firewall. This account must match the account added in the PAN profile on the managed device. The built-in admin account can be used for this purpose, but that is not recommended. It is better to create a new admin account used solely for the purpose of communications between the managed device and PAN firewall.
- Preconfiguration of PAN Host Information Profile (HIP) objects and HIP-profiles on the PAN Firewall to support a device-type based policy.

To enable these features, the following must be configured on the managed device:

- The system-wide PAN profile must be properly configured and made active on the managed device.
- The **pan-integration** parameter in the AAA profile to which the client is associated must be enabled.
- For VPN clients, enable the **pan-integration** parameter in the VPN authentication profile to which the client is associated.
- For VIA clients, enable the **pan-integration** parameter in the VIA authentication profile to which the client is associated.

## Limitations

Keep the following limitations in mind when configuring PAN Firewall Integration:

PAN Firewall Integration does not support bridge forwarding mode.

## Preconfiguration on the PAN Firewall

Before PAN Firewall configuration can be completed on the managed device, some configurations must be completed on the PAN Firewall.



## Certificate Management

The issuer certificate of the x509 server certificate used by the PAN firewall must be imported by Mobility Master as a trusted CA in order to establish a secure HTTPS connection between the firewall and the managed device.

## User-ID Support

The administrator must configure firewall policies based on the username and/or user group. Additionally, correct configuration of the connection to directory servers is required for user group based policies on the PAN firewall.

## Device-Type Based Policy Support

Managed devices support a limited number of device types. The identified device type associated with each IP user is sent to the PAN through the **client-version** field, with the **host-info** category of the HIP report. PAN administrators must create these HIP objects, which filter the HIP reports sent from the managed device to support device-based firewall policies.

[Table 128](#) lists the HIP objects with a specified **Is Value** in the **Client Version** field, which must be preconfigured on the PAN firewall.

**Table 128:** *HIP Objects*

Client Version Is Value
Android
Apple
AppleTV
BlackBerry
Chrome OS
iPad
iPhone
iPod
Kindle
Linux
Nintendo
Nintendo 3DS
Nintendo Wii

Client Version Is Value
Nook
OS X
PlayStation
PS Vita
PS3
PSP
RIM Tablet
Roku
Symbian
webOS
Win 7
Win 8
Win 95
Win 98
Win 2000
Win CE
Win ME
Win NT
Win Server
Win Vista
Win XP

Client Version Is Value
Windows
Windows Mobile
Windows Phone 7

## Configuring PAN Firewall Integration

A PAN profile must be created on the managed device. Multiple PAN profiles can be configured and saved on the managed device, but only one profile can be active at a time. These profiles can be configured and applied using the Mobility Master WebUI or CLI.




---

The following procedures describe the steps to integrate a Palo Alto Networks firewall policy using Mobility Master. For additional details on configuring PAN firewall integration, see [Managed Device Feature Overview on page 207](#)

---

### Creating PAN Profiles

The first step in configuring PAN firewall integration is to create PAN profiles. This profile provides the managed device with the information required for connecting to and interacting with the specified PAN firewall. The PAN profile can be created using the WebUI or CLI.




---

This configuration is only performed and available on the Mobility Master. The configuration is pushed to all connected to the managed devices.

---

### In the WebUI

To add a new PAN profile, complete the following steps:

1. In the **Mobility Master** node hierarchy, navigate to the **Configuration > System** page.
2. Select the **Profiles** tab.
3. Expand **Other Profiles** in the **All Profiles** list, and then select **Palo Alto Network Servers**.
4. Click **Add**.
5. Type the profile name into the **Profile Name** field, then click **Add**.
6. Enter the **Host (IP address or hostname)** of the PAN firewall
7. Enter the **Port (1 - 65535)** of the PAN firewall.
8. Enter the **Username** of the PAN firewall. The username must be between 1 and 255 bytes in length. The username must match the Admin account previously created on the PAN firewall.
9. Enter the **Password** of the username in PAN firewall. The password is between 6 and 100 bytes in length. The password must match the Admin account previously created on the PAN firewall.
10. Re-enter the **Password** entered in the previous step.
11. Click **OK**.
12. Click **Save**.
13. Select **Pending Changes**.
14. In the **Pending Changes** window, select the check box and click **Deploy changes**.

To add PAN firewalls to the PAN profile:

1. In the **Mobility Master** node hierarchy, navigate to the **Configuration > Systems** page.

2. Select the **Profiles** tab.
3. Expand **Other Profiles** in the **All Profiles** list, and then select the new PAN profile under **Palo Alto Networks Servers**.
4. Click **+** to add a PAN firewall to the PAN profile.
5. Enter the **host** (IP address or hostname) of the PAN firewall
6. Enter the **portnum** (port number between 1–65535) of the PAN firewall.
7. Enter the **username** of the PAN firewall. The username must be between 1 and 255 bytes in length. The username must match the admin account previously created on the PAN firewall.
8. Enter the **passwd** of the username in PAN firewall. The password must be between 6 and 100 bytes in length. The password must match the admin account previously created on the PAN firewall.
9. Re-enter the password.
10. Click **OK**.
11. Click **Save**.
12. Select **Pending Changes**.
13. In the **Pending Changes** window, select the check box and click **Deploy changes**.

### In the CLI

```
(host) [mynode] (config) #pan profile <profile-name>
    firewall host <host> port <port> username <username> passwd <password>
```

## Activating a PAN Profile

To activate a PAN Firewall profile, complete the following steps:




---

This configuration must be completed on each managed device.

---

1. In the **Mobility Master** node hierarchy, navigate to the **Configuration > System** page
2. Select the **Profiles** tab.
3. Expand **Other Profiles** in the **All Profiles** list, and then select the **Palo Alto Networks Active > Active Palo Alto Networks** profile.
4. Select the profile from the **Palo Alto Networks Servers Profile** drop-down list, and then click **+**.
5. Enter the **host** (IP address or hostname) of the PAN firewall
6. Enter the **portnum** (port number between 1 – 65535) of the PAN firewall.
7. Enter the **username** of the PAN firewall. The username must be between 1 and 255 bytes in length. The username must match the admin account previously created on the PAN firewall.
8. Enter the **passwd** for the PAN firewall. The password must be between 6 and 100 bytes in length. The password must match the admin account previously created on the PAN firewall.
9. Re-enter the password.
10. Click **OK**.
11. Click **Save**.
12. Select **Pending Changes**.
13. In the **Pending Changes** window, select the check box and click **Deploy changes**.

### In the CLI

```
(host) [mynode] (config) #pan active-profile
    profile <profile-name>
```

## Enabling PAN Firewall Integration

PAN firewall integration must be enabled on the AAA profile to which the client is associated.

### In the WebUI

To enable PAN firewall integration in the AAA profile:

1. In the **Mobility Master** node hierarchy, navigate to the **Configuration > System** page.
2. Select the **Profiles** tab.
3. Expand **Wireless LAN** in the **All Profiles** list, and then select **AAA**.
4. Select a **AAA** profile.
5. Select the **PAN Firewalls Integration** check box.
6. Click **Save**.
7. Select **Pending Changes**.
8. In the **Pending Changes** window, select the check box and click **Deploy changes**.

### In the CLI

```
(host) [mynode] (config) #aaa profile <aaa profile-name>
    pan-integration
```

## Enabling PAN Firewall Integration for VIA Clients

For VIA clients, PAN firewall integration must be enabled on the VIA authentication profile that is associated with the client.

### In the WebUI

To enable PAN firewall integration for VIA clients, complete the following steps:

1. In the **Mobility Master** node hierarchy, navigate to the **Configuration > System** page.
2. Select the **Profiles** tab.
3. Expand **Other Profiles** in the **All Profiles** list, and then select **VIA Authentication**.
4. Select a **VIA Authentication** profile.
5. Select the **PAN Firewalls Integration** check box.
6. Click **Save**.
7. Select **Pending Changes**.
8. In the **Pending Changes** window, select the check box and click **Deploy changes**.

### In the CLI

```
(host) [mynode] (config) #aaa authentication via auth-profile <profile-name>
    pan-integration
```

## Enabling PAN Firewall Integration for VPN Clients

For VPN clients, PAN firewall integration must be enabled on the VPN authentication profile that the client is associated with.

### In the WebUI

To enable PAN firewall integration for VPN clients:

1. In the **Mobility Master** node hierarchy, navigate to the **Configuration > System** page.
2. Select the **Profiles** tab.
3. Expand **Wireless LAN** in the **All Profiles** list, and then select **VPN Authentication**.

4. Select a **VPN Authentication** profile.
5. Select the **PAN Firewalls Integration** check box.
6. Click **Save**.
7. Select **Pending Changes**.
8. In the **Pending Changes** window, select the check box and click **Deploy changes**.

### In the CLI

```
(host) [mynode] (config) #aaa authentication vpn default
pan-integration
```

### Related Commands

Use the following CLI commands to view details for your PAN firewall configuration:

```
(host) [mynode] #show pan activate-profile
(host) [mynode] #show pan debug [uid-table slot-num <slot-num> [starting-rec <starting-rec>]]
(host) [mynode] #show pan profile
(host) [mynode] #show pan profile <profile-name>
(host) [mynode] #show pan state
(host) [mynode] #show pan statistics
(host) [mynode] #show profile-list pan profile [start <start>] [page <page>]
(host) [mynode] #show references pan active-profile [start <start>] [page
<page>]
(host) [mynode] #show references pan profile <profile-name> [start <start>]
[page <page>]
```

The Secure Remote Access Point Service allows AP users, at remote locations, to connect to an Aruba Mobility Master over the Internet. Because the Internet is involved, data traffic between the Mobility Master and the remote AP is VPN encapsulated. That is, the traffic between the Mobility Master and AP is encrypted. Remote AP operations are supported on all of Aruba's APs.

Topics in this chapter include:

- [About Remote Access Points on page 639](#)
- [Configuring the Secure Remote Access Point Service on page 640](#)
- [Deploying a Branch/Home Office Solution on page 646](#)
- [Enabling Remote AP Advanced Configuration Options on page 652](#)
- [Understanding Split Tunneling on page 667](#)
- [Understanding Bridge on page 673](#)
- [Provisioning Wi-Fi Multimedia on page 678](#)
- [Reserving Uplink Bandwidth on page 678](#)
- [Provisioning 4G USB Modems on Remote Access Points on page 679](#)
- [Configuring RAP-3WN and RAP-3WNP Access Points on page 681](#)
- [Converting an IAP to RAP or CAP on page 681](#)
- [Enabling Bandwidth Contract Support for RAPs on page 682](#)

## About Remote Access Points

Remote APs connect to a Mobility Master using Extended Authentication and Internet Protocol Security (XAuth/IPsec). AP control and 802.11 data traffic are carried through this tunnel. Secure Remote Access Point Service extends the corporate office to the remote site. Remote users can use the same features as corporate office users. For example, voice over IP (VoIP) applications can be extended to remote sites while the servers and the PBX remain secure in the corporate office.

For both RAPs and CAPs, tunneled SSIDs will be brought down eight seconds after the AP detects that there is no connectivity to the Mobility Master. However, RAP bridge-mode SSIDs are configurable to stay up indefinitely (always-on / persistent). For CAP bridge-mode SSIDs, the CAP will be brought down after the keepalive times out (default 3.5 minutes).

Secure Remote Access Point Service can also be used to secure control traffic between an AP and the Mobility Master in a corporate environment. In this case, both the AP and Mobility Master are in the company's private address space.

The remote AP must be configured with the IPsec VPN tunnel termination point. Once the VPN tunnel is established, the AP bootstraps and becomes operational. The tunnel termination point used by the remote AP depends upon the AP deployment, as shown in the following scenarios:

- Deployment Scenario 1: The remote AP and Mobility Master reside in a private network which secures AP-to-Mobility Master communication. (This deployment is recommended when AP-to-Mobility Master communications on a private network need to be secured.) In this scenario, the remote AP uses the Mobility Master's IP address on the private network to establish the IPsec VPN tunnel.
- Deployment Scenario 2: The remote AP is on the public network or behind a NAT device and the Mobility Master is on the public network. The remote AP must be configured with the tunnel termination point,

which must be a publicly-routable IP address. In this scenario, a routable interface is configured on the Mobility Master in the DMZ. The remote AP uses the Mobility Master's IP address on the public network to establish the IPsec VPN tunnel.

- Deployment Scenario 3: The remote AP is on the public network or behind a NAT device and the Mobility Master is also behind a NAT device. (This deployment is recommended for remote access.) The remote AP must be configured with the tunnel termination point, which must be a publicly-routable IP address. In this scenario, the remote AP uses the public IP address of the corporate firewall. The firewall forwards traffic to an existing interface on the Mobility Master. (The firewall must be configured to pass NAT-T traffic (UDP port 4500) to the Mobility Master.)

In any of the described deployment scenarios, the IPsec VPN tunnel can be terminated on a managed device, with a Mobility Master located elsewhere in the corporate network. The remote AP must be able to communicate with the Mobility Master after the IPsec tunnel is established. Make sure that the L2TP IP pool configured on the managed device (from which the remote AP obtains its address) is reachable in the managed device network by the Mobility Master.

## Configuring the Secure Remote Access Point Service

The tasks for configuring an Aruba Access Point as a Secure Remote Access Point Service are:

- Configure a public IP address for the Mobility Master.  
You must install one or more AP licenses in the Mobility Master. There are several AP licenses available that support different maximum numbers of APs. The licenses are cumulative; each additional license installed increases the maximum number of APs supported by the Mobility Master.
- Configure the VPN server on the Mobility Master. The remote AP will be a VPN client to the server.
- Provision the AP with IPsec settings, including the username and password for the AP, before you install it at the remote location. You can also provision the RAP using the zero touch provisioning method. For more information, see [Provisioning 4G USB Modems on Remote Access Points on page 679](#).

### Configure a Public IP Address for the Mobility Master

The remote AP requires an IP address to which it can connect to establish a VPN tunnel to the Mobility Master. This can be either a routable IP address you configure on the Mobility Master, or the address of an external router or firewall that forwards traffic to the Mobility Master. The following procedure describes how to create a DMZ address on the Mobility Master.

#### In the WebUI

1. In the **Managed Device** node hierarchy, navigate to the **Configuration > Interfaces > VLANs** page.
2. Click **+** to add a VLAN.
3. Enter the **VLAN name** and **VLAN ID/Range**.
4. Click **Submit**.
5. Click the VLAN ID created. The **VLANs>name** table is displayed.
6. Click the Vlan Id from **VLANs>name** table.
7. Click **Edit** on **Port Members**.
8. Click **<** to select the port that belongs to this VLAN .
9. Click **OK**.
10. Click **Submit**.
11. Click **IPv4** tab.
12. Enter the values for the **IPv4 address** field.



13. Click **Submit**.
14. Click **Pending Changes**.
15. In the **Pending Changes** window, select the check box and click **Deploy changes**.

### In the CLI

```
(host) [md] (config) #vlan <id>
(host) [md] (config) #interface vlan <id>
(host) [md] (config-submode) #ip address <ipaddr> <ipmask>
```

## Configure the NAT Device

Communication between the AP and the secure Mobility Master uses the UDP 4500 port. When both the Mobility Master and the AP are behind NAT devices, configure the AP to use the NAT device's public address as its master address. On the NAT device, you must enable NAT-T (UDP port 4500 only) and forward all packets to the public address of the NAT device on UDP port 4500 to the Mobility Master to ensure that the remote AP boots successfully.

## Configure the VPN Server

This section describes how to configure the IPsec VPN server on the Mobility Master. For more details, see [Virtual Private Networks on page 338](#). The remote AP will be a VPN client that connects to the VPN server on the Mobility Master.

### In the WebUI

1. In the **Managed Device** node hierarchy, navigate to the **Configuration > Services > VPN** tab.
2. Click **IKEv1** accordion.
3. Select **Enabled** from **L2tp** drop-down list.
4. Select **PAP (Password Authentication Protocol)** check box for **Auth protocols**.
5. To configure the L2TP IP pool, click **General Vpn** option.
6. Click **+** in the **Address Pools** table.
7. Enter the **Pool name** to configure the L2TP pool from which the APs will be assigned addresses.
8. Enter the value of the **Start address (ipv4/v6)** and **End address (ipv4/v6)** fields.
9. Click **Submit**.



---

The size of the pool should correspond to the maximum number of APs that the Mobility Master is licensed to manage.

---

10. To configure an Internet Security Association and Key Management Protocol (ISAKMP) encrypted subnet and preshared key, click the **Shared Secrets** accordion.
11. Click **+** in the **IKE Shared Secrets** table.
12. In the **Create IKE Group** table, enter the value for **Shared key** and re-enter the key in **Retype shared key**.
13. Click **Submit**.
14. Click **Pending Changes**.
15. In the **Pending Changes** window, select the check box and click **Deploy changes**.

### In the CLI

```
(host) [md] (config) #vpdn group l2tp
(host) [md] (config-submode) #ppp authentication PAP
```

```
(host) [md] (config-submode) #ip local pool <pool_name> <pool_start_address> <pool_end_address>
(host) [md] (config) #crypto isakmp key <keystring> address <ipaddr> netmask <mask>
```

## CHAP Authentication Support over PPPoE

RAPs can now establish a PPPoE session with a PPPoE server at the ISP side and get authenticated using the Challenge Handshake Authentication Protocol (CHAP). The PPPoE client running on a RAP is capable of handling the CHAP authentication requests from the PPPoE server.



---

The PPPoE client selects either the PAP or the CHAP credentials for the RAP authentication depending upon the request from the PPPoE server.

---

You can use the WebUI or the CLI to configure CHAP.

### In the WebUI

1. In the **Managed Device** node hierarchy, navigate to the **Configuration > Access Points > Remote APs** tab. The list of discovered APs are displayed on this page.
2. Select the AP you want to configure using CHAP and click **Provision**.
3. In the popup window click **Continue and Reboot**.
4. Click **Uplink** tab and enter the **CHAP Secret**.



---

You can use all the special characters except question mark (?) and the space can be used within double quotes (" ").

---

5. Enter the CHAP Secret again in the **Retype** text box for confirmation.
6. Click **Submit** and **Reboot**.
7. Click **Pending Changes**.
8. In the **Pending Changes** window, select the check box and click **Deploy changes**.

### In the CLI

```
(host) [md] (config) #provision-ap pppoe-chap-secret <KEY>
(host) [md] (config-submode) #reprovision ap-name <name>
```

## Configuring Certificate RAP

You can configure the remote AP to use the internal certificate for authentication. You can use the WebUI or CLI to configure the certificate RAP.

### In the WebUI

1. In the **Managed Network** node hierarchy, navigate to **Configuration > Access Points > Remote APs** tab.
2. Select the required Remote AP and click **Provision**.
3. In the popup window click **Continue and Reboot**.
4. Select the **Remote AP** check box.
5. Select **Certificate** from the **Authentication methods** drop-down list.
6. Click **Submit** to apply the configuration and reboot the AP as certificate RAP.
7. Click **Pending Changes**.
8. In the **Pending Changes** window, select the check box and click **Deploy changes**.

## In the CLI

```
(host) [mynode] (config) #whitelist-db rap add <mac-address>
```

## Creating a Remote AP Whitelist

If you use the Zero Touch provisioning method to provision the certificate RAP, then you must create a remote AP whitelist. For more information on Zero Touch Provisioning of the RAP, see [Provisioning 4G USB Modems on Remote Access Points on page 679](#).

Remote AP whitelist is the list of approved APs that can be provisioned on your Mobility Master.

### In the WebUI

1. In the **Managed Network** node hierarchy, navigate to **Configuration > Access Points > Whitelist** tab.
2. Click **Remote AP Whitelist** tab.
3. Click **+** and provide the following details:
  - **MAC Address**—mandatory parameter. Enter the MAC address of the AP.
  - **AP Group**—select a group to add the AP.
  - **AP Name**—enter a name for the AP. If you do not enter an AP name, the MAC address will be used instead.
  - **Description**—enter a text description for the AP
4. Click **Submit** to add the remote AP to the whitelist.
5. Click **Pending Changes**.
6. In the **Pending Changes** window, select the check box and click **Deploy changes**.

## Configuring PSK RAP

You can use Pre-Shared Key (PSK) authentication to provision an individual remote AP or a group of remote APs using an Internet Key Exchange Pre-Shared Key (IKE PSK).

### In the WebUI

1. In the **Managed Network** node hierarchy, navigate to **Configuration > Access Points > Remote APs** tab.
2. Select the required Remote AP and click **Provision**.
3. In the popup window click **Continue and Reboot**.
4. In the **General** tab, select **Pre-shared Key** from the **Authentication methods** drop-down list.
5. Enter and confirm the pre-shared key (IKE PSK).
6. Select **Global User Name/password** or a **Per AP User Name/Password** from **User credential assignment** drop-down list.
  - a. If you use the **Per AP User Names/Passwords** option, each RAP is given its own username and password.
  - b. If you use the **Global User Name/Password** option, all selected RAPs are given the same (shared) username and password.
7. Enter the user name, and enter and confirm the password. If you want the managed device to automatically generate a user name and password, select **Use Automatic Generation**. If this option is not selected, the user has to enter it manually.
8. Click **Submit**.
9. Click **Pending Changes**.
10. In the **Pending Changes** window, select the check box and click **Deploy changes**.

## Add the User to the Internal Database

You can add the user to the internal database using the WebUI or CLI.

### In the WebUI

1. In the **Mobility Master** node hierarchy, navigate to the **Configuration > Authentication > Auth Servers** tab.
2. From the **All Servers** table, select **Internal** under the **Name** field.
3. Click **+** in the **Users** tab. The **Internal Server > Add New User** page is displayed.
4. Enter the **User Name** and **Password**.
5. Select **Enabled** from the **Enabled** drop-down list to activate this entry on creation.
6. Click **Submit**. Note that the configuration does not take effect until you perform this step.
7. Click **Pending Changes**.
8. In the **Pending Changes** window, select the check box and click **Deploy changes**.

### In the CLI

Execute the following command in enable mode.

```
(host) [mynode] (config) #local-userdb add username rapuser1 password <password>
```

## RAP Static Inner IP Address

The RAP static inner IP address feature assigns a static inner IP address to a remote access point (RAP). A new *remote-IP address* parameter is added to the existing configuration commands.

### In the WebUI

To view IP address parameter in the local database:

1. In the **Managed Network** node hierarchy, navigate to the **Configuration > Authentication > Auth Servers** tab.
2. In the **All Servers** table, select **Internal** under the **Name** field.
3. A list of **STATIC IPS FOR RAPs** is displayed under **Server > Internal** table.

To view the IP Address parameter in the RAP Whitelist:

1. In the **Managed Network** node hierarchy, navigate to the **Configuration > Access Points > Remote APs** tab.

### In the CLI

Execute the following command in enable mode:

```
(host) [mynode] (config) #local-userdb add {generate-username|username <name>} {generate-password|password <password>} {remote-ip <remote-ip>}
(host) [mynode] (config) #local-userdb modify {username < name>} {remote-ip <remote-ip>}
```

Issue the following command in config mode:

```
(host) [mynode] (config) #whitelist-db rap add {mac-address <address>} {ap-group <ap_group>}
{remote-ip <remote-ip>}
(host) [mynode] (config) #whitelist-db rap modify {mac-address <address>} {remote-ip<remote-
ip>}
```



---

You cannot configure the IP Address parameter using the WebUI.

---

## Provision the AP

You need to configure the VPN client settings on the AP to instruct the AP to use IPsec to connect to the Mobility Master. You can provision the RAP and allow remote users to provision the AP at home. This method of provisioning is referred to as Zero Touch Provisioning. See [Provisioning 4G USB Modems on Remote Access Points on page 679](#) for more information about Zero Touch Provisioning of remote AP.

You must provision the AP before you install it at its remote location. To provision the AP, the AP must be physically connected to the local network or directly connected to the Mobility Master. When connected and powered on, the AP must also be able to obtain an IP address from a DHCP server on the local network or from the Mobility Master.

If your configuration has an internal LMS IP address, remote APs may attempt to switch over to the LMS IP address, which is not reachable from the Internet. For remote APs, ensure that the LMS IP address in the AP system profile for the AP group has an externally routable IP address.

Reprovisioning the AP causes it to automatically reboot. The easiest way to provision an AP is to use the Provisioning page in the WebUI, as described in the following steps:

1. In the **Managed Network** node hierarchy, navigate to the **Configuration > Access Points > Remote APs** tab.
2. Select the remote AP and click **Provision**.
3. Select **Pre-shared Key** from the **Authentication Methods** drop-down list.
4. Enter the **User name**, **Password**, and **Confirm password**.



---

The username and password you enter must match the username and password configured on the authentication server for the remote AP.

---

5. Select the **Static** option in the **Controller Discovery** field.
6. Set the **Controller IP/DNS** name as shown below:

**Table 129:** *Configuring a Managed device IP Address*

Deployment Scenario	Master IP Address Value
Deployment 1	Managed device IP address.
Deployment 2	Managed device public IP address.
Deployment 3	Public address of the NAT device to which the managed device is connected.



---

The username and password you enter must match the username and password configured on the authentication server for the remote AP.

---

7. Select **DHCP** option in the **IP** field.
8. Click **Submit**.
9. Click **Pending Changes**.
10. In the **Pending Changes** window, select the check box and click **Deploy changes**.

## Secondary Managed Device

The secondary managed device provides reliability and redundancy; however the functionality of a secondary managed device is initiated only after an AP terminates on a managed device successfully and retrieves the configuration. If the AP boots up and fails to connect to the managed device the AP cannot be managed. To address this, ArubaOS 8.0 introduces the secondary managed device feature.

In a scenario where the managed device is not reachable, the AP will try to reach the secondary managed device and if successful will terminate on the secondary managed device. The secondary managed device details are not stored in the system flash when the AP is deployed for the first time, but only after a successful configuration. An AP can use the secondary managed device feature after the AP reboots.



---

If an AP has not been configured to a managed device after deployment, the secondary managed device feature will not be applicable.

---

### In the WebUI

To enable the secondary managed device feature:

1. In the **Managed Network** node hierarchy, navigate to **Configuration > System > Profiles**.
2. Select **AP > AP System** under **All Profiles**.
3. Select the AP profile for which the secondary managed device feature is to be enabled. The AP system profile section is displayed.
4. Enter an IP or FQDN value for the secondary managed device in the **Secondary Master IP/FQDN** field.
5. Click **Save**.
6. Click **Pending Changes**.
7. In the **Pending Changes** window, select the check box and click **Deploy changes**.



---

The secondary managed device feature can be enabled on the secondary managed device.

---

### In the CLI

Execute the following command to enable the secondary managed device feature.

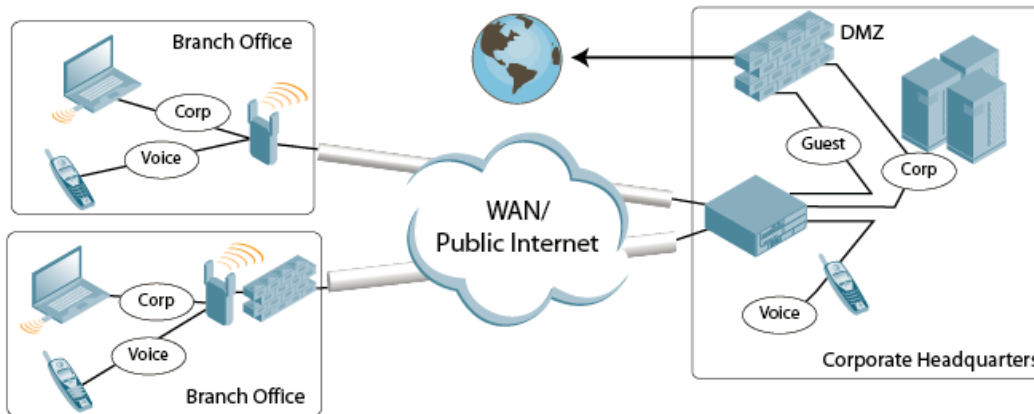
```
(host) [mynode] (config) #ap system-profile <profile name>
(host) [mynode] (AP system profile "profile name")#secondary-master <value>
```

## Deploying a Branch/Home Office Solution

In a branch office, the AP is deployed in a separate IP network from the corporate network. Typically, there are one or two NAT devices between the two networks. Branch office users need access to corporate resources such as printers and servers, but traffic to and from these resources must not impact the corporate head office.

[Figure 48](#) is a graphic representation of a remote AP in a branch or home office, with a single Mobility Master providing access to both a corporate WLAN and a branch office WLAN.

**Figure 48** Remote AP with Single Managed device



Branch office users want continued operation of the branch office WLAN, even if the link to the corporate network goes down. The branch office AP solves these requirements by providing the following capabilities on the branch office WLAN:

- Local termination of 802.11 management frames which provides survivability of the branch office WLAN.
- All 802.1X authenticator functionality is implemented in the AP. The Mobility Master is used as a RADIUS pass-through when the authenticator has to communicate with a RADIUS server (which also supports survivability).
- 802.11 encryption/decryption is in the AP to provide access to local resources.
- Local bridging of client traffic connected to the WLAN or to an AP 70 enet1 port to provide access to local resources.

## Provisioning the Branch AP

You can provision the remote AP either using the Mobility Master or using the Zero Touch Provisioning method. For more information on Mobility Master provisioning, see [Configuring Installed APs on page 509](#). For more information on Zero Touch Provisioning, see [Provisioning 4G USB Modems on Remote Access Points on page 679](#).

## Configuring the Branch AP

- Specify forward mode for the Extended Service Set Identifier (ESSID) in the virtual AP profile
- Specify remote AP operation in the virtual AP profile (The remote AP operates in standard mode by default.)
- Set how long the AP stays up after connectivity to Mobility Master has gone down in the SSID profile
- Set the VLAN ID in the virtual AP profile
- Set the native VLAN ID in the AP system profile
- Set forward mode for enet1 port



---

Remote APs support 802.1q VLAN tagging. Data from the remote AP will be tagged on the wired side.

---

## Troubleshooting Remote AP

The following WebUI options are available to troubleshoot issues with remote AP:

- Using local debugging feature
- Viewing the remote AP summary report

- Viewing remote AP connectivity report
- Using remote AP diagnostic options

## Local Debugging

Local debugging is a WebUI feature that allows end users to perform diagnostics and view the status of their remote AP through a wired or wireless client. This feature is useful for troubleshooting connectivity problems on remote APs and performing throughput tests. There are three tabs in the **Local Debugging** WebUI window; **Summary**, **Connectivity**, and **Diagnostics**. Each tab displays different information for the AP, but all three tabs include a **Generate & save support file** link that, when clicked, will automatically generate a **support.tgz** file that can be sent to a corporate IT department for additional analysis and debugging.



---

A snapshot of the bridge, acl, session, user, and arp tables, current processes, memory, and kernel debug messages are captured in a single **rap\_debug.txt** file which is bundled along with **support.tgz** file.

---

## Remote AP Summary

The **Summary** tab has two views; basic and advanced. Click the **basic** or **advanced** links at the top of this tab to toggle between the two views. The table below shows the information displayed for both the basic and advanced views of the **Summary** tab.



**Table 130:** RAP Console Summary Tab Information

Summary Table Name	Basic View Information	Advanced View Information
Wired Ports Status	<ul style="list-style-type: none"> <li>● <b>Port:</b> port numbers of the wired ports on the AP</li> <li>● <b>Status:</b> current status of each port (<i>Connected, LinkDown or Disabled</i>).</li> </ul>	<p>The advanced view of the Wired Access Ports table displays the following data:</p> <ul style="list-style-type: none"> <li>● <b>Port:</b> port numbers of the wired ports on the AP</li> <li>● <b>Status:</b> current status of each port (<i>Connected, LinkDown or Disabled</i>)</li> <li>● <b>MAC Address:</b> MAC address of the wired port</li> <li>● <b>Speed:</b> speed of the link</li> <li>● <b>Duplex Type:</b> duplex mode of the link, full or half</li> <li>● <b>Forwarding mode:</b> forwarding mode for the port: <i>Bridge, Tunnel or Split Tunnel</i></li> <li>● <b>Users:</b> number of users accessing each port</li> <li>● <b>Rx Packets:</b> number of packets received on the port</li> <li>● <b>Tx packets:</b> number of packets transmitted via the port</li> </ul>
Wireless SSIDs	<ul style="list-style-type: none"> <li>● <b>SSID:</b> Name of the SSID.</li> <li>● <b>Status:</b> SSID Status (up, down, or disabled).</li> <li>● <b>Band:</b> Radio band available on the SSID.</li> </ul>	<ul style="list-style-type: none"> <li>● <b>SSID:</b> name of the SSID</li> <li>● <b>Status:</b> SSID Status (up, down, or disabled).</li> <li>● <b>Band:</b> radio band available on the SSID</li> <li>● <b>Channel:</b> channel used on the radio band</li> <li>● <b>BSSID:</b> BSSID of the wireless SSID</li> <li>● <b>Forwarding Mode:</b> forwarding mode used by the Wireless SSID (<i>Bridge, Tunnel or Split-Tunnel</i>)</li> <li>● <b>EIRP:</b> equivalent Isotropic Radiated Power, in dBm</li> <li>● <b>Noise floor:</b> residual background noise detected by an AP. Noise seen by an AP is reported as -dBm Therefore, a noise floor of -100 dBm is smaller (lower) than a noise floor of -50 dBm.</li> <li>● <b>Users:</b> number of users on the radio band</li> <li>● <b>Rx Packets:</b> number of packets received on the BSSID</li> <li>● <b>Tx packets:</b> number of packets transmitted via the BSSID</li> </ul>

Summary Table Name	Basic View Information	Advanced View Information
Wired Users	<ul style="list-style-type: none"> <li>● <b>MAC Address:</b> MAC address of the wired user.</li> <li>● <b>IP address:</b> IP address of the wired user.</li> </ul>	<ul style="list-style-type: none"> <li>● <b>MAC Address:</b> MAC address of the wired user.</li> <li>● <b>IP address:</b> IP address of the wired user.</li> <li>● <b>Port:</b> AP port used by the wired user.</li> </ul>
Wireless User	<ul style="list-style-type: none"> <li>● <b>MAC Address:</b> MAC address of the wireless user.</li> <li>● <b>IP address:</b> IP address of the wireless user.</li> </ul>	<ul style="list-style-type: none"> <li>● <b>MAC Address:</b> MAC address of the wired user</li> <li>● <b>IP address:</b> IP address of the wired user</li> <li>● <b>SSID:</b> name of the SSID</li> <li>● <b>BSSID:</b> BSSID of the wireless user</li> <li>● <b>Assoc State:</b> shows if the user is associated or just authorized</li> <li>● <b>Auth:</b> Type of authentication: WPA, 802.1X, none, open, or shared</li> <li>● <b>Encryption:</b> encryption type used by the wireless user</li> <li>● <b>Band:</b> radio band used by the wireless client</li> <li>● <b>RSSI:</b> Receive Signal Strength Indicator (RSSI) value displayed in the output of this command represents signal strength as a signal to noise ratio.</li> </ul>
Device Info	<ul style="list-style-type: none"> <li>● <b>Type:</b> AP device/model type.</li> <li>● <b>Name:</b> Name assigned to the AP.</li> <li>● <b>Wired MAC address:</b> MAC address of the wired port.</li> <li>● <b>Serial #:</b> AP serial number.</li> <li>● <b>Tunnel IP address:</b> IP address of the tunnel between the AP and managed device.</li> <li>● <b>Software Version:</b> Software version currently running on the AP.</li> <li>● <b>Uptime:</b> Amount of time the AP has been active since it was last reset.</li> <li>● <b>Master:</b> IP address of the Mobility Master.</li> <li>● <b>Im:</b> IP address of the managed device.</li> </ul>	N/A

Summary Table Name	Basic View Information	Advanced View Information
Uplink Info	<p>The Uplink Info table can display some or all of the following information for your remote AP, depending upon whether a link is active and the number of links supported by the AP.</p> <p>Active uplink information, including:</p> <ul style="list-style-type: none"> <li>• Interface name</li> <li>• Port speed</li> <li>• IP address</li> </ul> <p>Standby link information, including:</p> <ul style="list-style-type: none"> <li>• Name (3G)</li> <li>• <b>Device connected</b> (yes/no)</li> <li>• <b>Provisioned</b> (yes/no)</li> <li>• IP address</li> <li>• Device</li> <li>• User</li> <li>• Password</li> </ul>	N/A

### Multihoming on remote AP (RAP)

You can uplink a RAP as an Ethernet or a USB based modem. These uplinks can be used as a backup link if the primary link fails. The uplink becomes active based on the order of priority configured on the RAP. The RAP switches back to the primary link when the primary connection is restored.

For information on provisioning the RAP using the USB based modem, see [Provisioning 4G USB Modems on Remote Access Points on page 679](#).

### Seamless failover from backup link to primary link on RAP

RAPs can failover from a backup link to a primary link without much disruption to traffic. Also the failover is performed only if the Mobility Master is reachable via the primary link.

### Remote AP Connectivity

The information shown on the **Connectivity** tab will vary, depending upon the current status of the remote AP. If a remote AP has been successfully provisioned and connected, it should display some or all of the information in [Table 131](#).

**Table 131:** RAP Console Connectivity Tab Information

Data	Description
Uplink status	Shows if the link connected failed. If the link is connected, the Uplink status also displays the name of the interface.
IP Information	If the AP has successfully received an IP address, this data row will show the AP's IP address, subnet mask, and gateway IP address.
Gateway Connectivity	If successful, this item also shows the percentage of packet loss for data received from the gateway.
TPM Certificates	If successful, the AP has a Trusted Platform Module (TPM) certificate.
Master Connectivity	Shows if the AP was able to connect to the Mobility Master. This item also shows the IP address to which the AP attempted to connect, and, if the AP did connect successfully, the link used to connect to that Mobility Master.
LMS Connectivity	Shows if the AP was able to connect to a managed device. This item also shows the IP address to which the AP attempted to connect, and, if the AP did connect successfully, the link used to connect to that Mobility Master.

The top of the **Connectivity** tab has a **Refresh** link that allows users to refresh the data on their screen. Additional information at the bottom of this tab shows the date, time, and reason the remote AP last rebooted. The **Reboot RAP Now** button reboots the remote AP.

## Remote AP Diagnostics

Use the **Diagnostics** tab to view log files, or run diagnostic tests that can help the IT department troubleshoot errors.

To run a diagnostic test on a remote AP:

1. In the **Mobility Master** node hierarchy, navigate to the **Diagnostics > Tools** menu.
2. Select **Ping**, **Traceroute**, or **Tracepath** tab.

The *ping* and *traceroute* tests require that you enter a network destination in the form of an IP address or fully-qualified domain name, and select either **bridge** or **tunnel** mode for the test. The *NSLookup* diagnostic test requires that you enter a destination only. The test checks the link between the AP and the Mobility Master, and does not require any additional test configuration settings.

3. Click **Trace** to start the test. The results of the test will appear in the **Diagnostics** window.
4. To view log files in a separate browser window:
  - a. Click **Diagnostics > Logs** menu.
  - b. Select a log file name from the **Logs** drop-down list. The type of log files available will vary, depending upon your remote AP configuration.
  - c. Click **Display**.

## Enabling Remote AP Advanced Configuration Options

This section describes the following features designed to enhance your remote AP configuration:

- [Understanding Remote AP Modes of Operation on page 653](#)

- [Working in Fallback Mode on page 655](#)
- [Specifying the DNS Mobility Master Setting on page 663](#)
- [Backup Managed Device List on page 664](#)
- [Configuring Remote AP Failback on page 665](#)
- [Working with Access Control Lists and Firewall Policies on page 667](#)
- [Understanding Split Tunneling on page 667](#)
- [Provisioning Wi-Fi Multimedia on page 678](#)



---

The information in this section assumes you have already configured the remote AP functionality, as described in [Configuring the Secure Remote Access Point Service on page 640](#).

---

## Understanding Remote AP Modes of Operation

[Table 132](#) summarizes the different remote AP modes of operation. You specify both the forward mode setting (which controls whether 802.11 frames are tunneled to the Mobility Master using GRE, bridged to the local Ethernet LAN, or a combination thereof) and the remote AP mode of operation (when the virtual AP operates on a remote AP) in the virtual AP profile.

The column on the left of the table lists the remote AP operation settings. The row across the top of the table lists the forward mode settings. To understand how these settings work in concert, scan the desired remote AP operation with the forward mode setting, and read the information in the appropriate table cell.

The all column and row lists features that all remote AP operation and forward mode settings have in common regardless of other settings. For example, at the intersection of all and bridge, the description outlines what happens in bridge mode regardless of the remote AP mode of operation.

**Table 132:** Remote AP Modes of Operation and Behavior

Remote AP Operation Setting	Forward Mode Setting				
	all	bridge	split-tunnel	tunnel	decrypt-tunnel
<b>all</b>		<p>Management frames on the AP.</p> <p>Frames are bridged between wired and wireless interfaces.</p> <p>No frames are tunneled to the Mobility Master.</p> <p>Station acquires its IP address locally from an external DHCP server.</p>	<p>Management frames on the AP.</p> <p>Frames are either GRE tunneled to the Mobility Master to a trusted tunnel or NATed and bridged on the wired interface according to user role and session ACL.</p> <p>Typically, the station obtains an IP address from a VLAN on the Mobility Master.</p> <p>Typically, the AP has ACLs that forward corporate traffic through the tunnel and source NAT the non-corporate traffic to the Internet.</p>	<p>Frames are GRE tunneled to the Mobility Master to an untrusted tunnel.</p> <p>100% of station frames are tunneled to the Mobility Master.</p>	<p>Management frames on the AP.</p> <p>Frames are always GRE tunneled to Mobility Master.</p>
<b>always</b>	<p>ESSID is always up when the AP is up regardless of whether the Mobility Master is reachable.</p> <p>Supports PSK ESSID only.</p> <p>SSID configuration stored in flash on AP.</p>	<p>Provides an SSID that is always available for local access.</p>	<p>Not supported</p>	<p>Not supported</p>	<p>Not supported</p>

Remote AP Operation Setting	Forward Mode Setting				
	all	bridge	split-tunnel	tunnel	decrypt-tunnel
<b>backup</b>	ESSID is only up when the Mobility Master is unreachable.  Supports PSK ESSID only.  SSID configuration stored in flash on AP.	Provides a backup SSID for local access only when the Mobility Master is unreachable.	Not supported	Not supported	Not supported
<b>persistent</b>	ESSID is up when the AP contacts the Mobility Master and stays up if connectivity is disrupted with the Mobility Master.  SSID configuration obtained from the Mobility Master.  Designed for 802.1X SSIDs.	Same behavior as standard, described below, except the ESSID is up if connectivity to the Mobility Master is lost.	Not supported	Not supported	Not supported
<b>standard</b>	ESSID is up only when there is connectivity with the Mobility Master.  SSID configuration obtained from the Mobility Master.	Behaves like a classic Aruba branch office AP.  Provides a bridged ESSID that is configured from the Mobility Master and stays up if there is Mobility Master connectivity.	Split tunneling mode	Classic Aruba thin AP operation	Decrypt tunnel mode

## Working in Fallback Mode

The fallback mode (also known as backup configuration) operates the remote AP if the master Mobility Master or the configured primary and backup LMS are unreachable. The remote AP saves configuration information that allows it to operate autonomously using one or more SSIDs in local bridging mode, while supporting open

association or encryption with PSKs. You can also use the backup configuration if you experience network connectivity issues, such as the WAN link or the central data center becoming unavailable. With the backup configuration, the remote site does not go down if the WAN link fails or the data center is unavailable.

You define the backup configuration in the virtual AP profile on the Mobility Master. The remote AP checks for configuration updates each time it establishes a connection with the Mobility Master. If the remote AP detects a change, it downloads the configuration changes.

The following remote AP backup configuration options define when the SSID is advertised (refer to [Table 132](#) for more information):

- Always - Permanently enables the virtual AP. Recommended for bridge SSIDs.
- Backup - Enables the virtual AP if the remote AP cannot connect to the Mobility Master. This SSID is advertised until the Mobility Master is reachable. Recommended for bridge SSIDs.
- Persistent - Permanently enables the virtual AP after the remote AP initially connects to the Mobility Master. Recommended for 802.1X SSIDs.
- Standard - Enables the virtual AP when the remote AP connects to the Mobility Master. Recommended for 802.1X, tunneled, and split-tunneled SSIDs. This is the default behavior.

While using the backup configuration, the remote AP periodically retries its IPsec tunnel to the Mobility Master. If you configure the remote AP in backup mode, and a connection to the Mobility Master is re-established, the remote AP stops using the backup configuration and immediately brings up the standard remote AP configuration. If you configure the remote AP in always or persistent mode, the backup configuration remains active after the IPsec tunnel to the Mobility Master has been re-established.

## Backup Configuration Behavior for Wired Ports

If the connection between the remote AP and the Mobility Master is disconnected, the remote AP will exhibit the following behavior:

- All access ports on the remote AP will be moved to bridge forwarding mode, irrespective of their original forwarding mode.
- Clients will receive an IP address from the remote AP's DHCP server.
- Clients will have complete access to Remote AP's uplink network. You cannot enforce or modify any access control policies on the clients connected in this mode.

This section describes the following topics:

- [Configuring Fallback Mode on page 656](#)
- [Configuring the DHCP Server on the Remote AP on page 657](#)
- [Configuring Advanced Backup Options on page 659](#)

## Configuring Fallback Mode

To configure the fallback mode, you must:

- Configure the AAA profile
- Configure the virtual AP profile

## Configuring the AAA Profile for Fallback Mode

### In the WebUI

The AAA profile defines the authentication method and the default user role for unauthenticated users:

1. In the **Managed Device** node hierarchy, navigate to the **Configuration > System > Profiles** tab.
2. Select **Wireless LAN > AAA** under **All Profiles**.
3. In the **AAA Profile: New Profile** table, click + in **AAA Profile**.



4. Enter the **Profile name**.
5. For **Initial role**, select the appropriate role (for example, logon) from the drop-down list.
6. For **802.1X Authentication Default Role**, select the appropriate role (for example, default) from the drop-down list.
7. Click **Save**.
8. Select the AAA profile that you just created:
  - a. Click **802.1X Authentication Server Group**, and select the **Server Group** to be used (for example, default) from the drop-down list.
  - b. Click **Save**.




---

If you need to create an 802.1X Authentication Server Group, select **new** from the **802.1X Authentication Server Group** drop-down list, and enter the appropriate parameters.

---

- c. Click **802.1X Authentication**, and select the **802.1X Authentication Profile** to be used (for example, "default") from the drop-down list.
  - d. Click **Save**.
9. Click **Pending Changes**.
10. In the **Pending Changes** window, select the check box and click **Deploy changes**.

#### In the CLI

```
(host) [md] (config) #aaa profile default
(host) [md] (AAA Profile "default") #initial-role <role>
(host) [md] (AAA Profile "default") #authentication-dot1x <dot1x-profile>
(host) [md] (AAA Profile "default") #dot1x-default-role <role>
(host) [md] (AAA Profile "default") #dot1x-server-group <group>
```

## Configuring the DHCP Server on the Remote AP

You can configure the internal DHCP server on the remote AP to provide an IP address for the backup SSID if the Mobility Master is unreachable. If configured, the remote AP DHCP server intercepts all DHCP requests and assigns an IP address from the configured DHCP pool.

To configure the remote AP DHCP server:

1. Enter the VLAN ID for the remote AP DHCP VLAN in the AP system profile. This VLAN enables the DHCP server on the AP (also known as the remote AP DHCP server VLAN). If you enter the native VLAN ID, the DHCP server is not configured and is unavailable.
2. Specify the DHCP IP address pool and netmask. The AP assigns IP addresses from the DHCP pool 192.168.11.0/24 by default, with an IP address range from 192.168.11.2 through 192.168.11.254. You can manually define the DHCP IP address pool and netmask based on your network design and IP address scheme.
3. Specify the IP address of the DHCP server, DHCP router, and the DHCP DNS server. The AP uses IP address 192.168.11.1 for the DHCP server, the DHCP router, and the DHCP DNS server by default.
4. Enter the amount of days the assigned IP address is valid (also known as the remote AP DHCP lease). The lease does not expire by default, which means the IP address is always valid.
5. Assign the VLAN ID for the remote AP DHCP VLAN to a virtual AP profile. When a client connects to that virtual AP profile, the AP assigns the IP address from the DHCP pool.



---

The following is a high-level description of the steps required to configure the DHCP server on the remote AP. The steps assume you have already created the virtual AP profile, AAA profile, SSID profile, and other settings for your remote AP operation (for information about the backup configuration, see [Configuring Fallback Mode on page 656](#)).

---

### In the WebUI

1. In the **Managed Device** node hierarchy, navigate to the **Configuration > AP Groups** menu option.
2. Select an **AP Group**.
3. Click **More** tab and add the appropriate value in the following fields:
  - a. Enter the LMS IP address in the **LMS IP address** field and the Backup LMS IP address in the **Backup LMS IP address** field.
  - b. Enter the LMS IPv6 address in the **LMS IPv6 address** field and the Backup LMS IPv6 address in the **Backup LMS IPv6 address** field.
  - c. Click **Submit**.
4. In the **Managed Networks** node hierarchy, navigate to **Configuration > System > Profiles** tab.
  - a. Select **AP > AP System** under **All Profiles**, and select an AP system profile.
  - b. Click **Remote AP** accordion.
  - c. Enter the VLAN ID of the backup configuration virtual AP VLAN in the **Remote-AP DHCP Server VLAN** field.
  - d. Enter the IP address of the DHCP server in the **Remote-AP DHCP Server ID** field.
  - e. Enter the IP address of the default DHCP router in the **Remote-AP DHCP Default Router** field.
  - f. Specify the DHCP IP address pool. This configures the pool of IP addresses from which the remote AP uses to assign IP addresses.
    - Enter the first IP address of the pool, in the **Remote-AP DHCP Pool Start** field.
    - Enter the last IP address of the pool, in the **Remote-AP-DHCP Pool End** field.
    - Enter the netmask, in the **Remote-AP-DHCP Pool Netmask** field.
  - g. Specify the number of days for which the IP address is valid, in the **Remote-AP DHCP Lease Time** field.
  - h. Click **Save**.
  - i. Select **Wireless LAN > Virtual AP** under **All Profiles**, and the select virtual AP profile you want to configure.
  - j. Click **Save**.
5. Click **Pending Changes**.
6. In the **Pending Changes** window, select the check box and click **Deploy changes**.

### In the CLI

Use the following commands:

```
(host) [md] (config) #ap system-profile default
(host) [md] (AP system profile "default") #lms-ip <ipaddr>

(host) [md] (AP system profile "default") #master-ip <ipaddr>

(host) [md] (AP system profile "default") #rap-dhcp-default-router <ipaddr>

(host) [md] (AP system profile "default") #rap-dhcp-dns-server <ipaddr>

(host) [md] (AP system profile "default") #rap-dhcp-lease <days>

(host) [md] (AP system profile "default") #rap-dhcp-pool-end <ipaddr>
```

```

(host) [md] (AP system profile "default") #rap-dhacp-pool-netmask <netmask>

(host) [md] (AP system profile "default") #rap-dhcp-pool-start <ipaddr>

(host) [md] (AP system profile "default") #rap-dhcp-server-id <ipaddr>

(host) [md] (AP system profile "default") #rap-dhcp-server-vlan <vlan>

(host) [md] (config) #wlan virtual-ap default
(host) [md] (Virtual AP profile "default") #ssid-profile <profile>

(host) [md] (Virtual AP profile "default") #vlan <vlan>

(host) [md] (Virtual AP profile "default") #forward-mode bridge

(host) [md] (Virtual AP profile "default") #aaa-profile <name>

(host) [md] (Virtual AP profile "default") #rap-operation {always|backup|persistent}

(host) [md] (config) #ap-group default
(host) [md] (AP group "default") #virtual-ap <name>

```

or

```

(host) [md] (config) #ap-name default
(host) [md] (AP name "default") #virtual-ap <name>

```

## Configuring Advanced Backup Options

You can also use the backup configuration (fallback mode) to allow the remote AP to pass through a captive portal, such as network access in a hotel, airport, or other public network, to access the corporate network. For this scenario:

- Define a session ACL for the bridge SSID to source NAT all user traffic, except DHCP. For example, use **any any svc-dhcp permit** followed by **any any any route src-nat**. Apply the session ACL to a remote AP user role.
- Configure the AAA profile. Make sure the initial role contains the session ACL previously configured. The AAA profile defines the authentication method and the default user role.




---

802.1X and PSK authentication is supported when configuring bridge or split tunnel modes.

---

- Configure the virtual AP profile for the backup configuration:
  - Set the remote AP operation to **always** or **backup**.
  - Create and apply the applicable SSID profile.
  - Configure a bridge SSID for the backup configuration. In the virtual AP profile, specify forward mode as **bridge**.

For more information about the backup configuration, see [Configuring Fallback Mode on page 656](#).

- Enter the remote AP DHCP server parameters in the AP system profile. For more information about the parameters, see [Configuring the DHCP Server on the Remote AP on page 657](#).

If you use a local DHCP server to obtain IP addresses, you must define one additional ACL to permit traffic between clients without source NATing the traffic. Using the previously configured ACL, add **user alias internal-network any permit** before **any any any route src-nat**.

- Connect the remote AP to the available public network (for example, a hotel or airport network).

The remote AP advertises the backup SSID so the wireless client can connect and obtain an IP address from the available DHCP server.



---

The client can obtain an IP address from the public network, for example a hotel or airport, or from the DHCP server on the remote AP.

---

After obtaining an IP address, the wireless client can connect and access the corporate network and bring up the configured corporate SSIDs.

The following is a high-level description of what is needed to configure the remote AP to pass through a captive portal and access the corporate Mobility Master. This information assumes you are familiar with configuring session ACLs, AAA profiles, virtual APs, and AP system profiles and highlights the modified parameters.

## Configuring the Session ACL

### In the WebUI

1. In the **Managed Device** node hierarchy, navigate to the **Configuration > Roles and Policies > Policies** tab.
2. Click **+** to create a new policy.
3. Enter the policy name in the **Policy Name** field.
4. From the **Policy Type** drop-down list, select **Session**.
5. Click **Submit**.
6. To create the first rule:
  - a. Select the policy created.
  - b. Click **+** in the **Policies > New Policy** table.
  - c. Select **Access Control** option in the **Rule Type** field.
  - d. Click **OK**.
  - e. Select **Any** from the **Source** drop-down list.
  - f. Select **Any** from the **Destination** drop-down list.
  - g. Select **Service** from the **Service/app** drop-down list.
  - h. Select **svc-dhcp** from the **Service alias** drop-down list.
  - i. Select **Permit** from the **Action** drop-down list.
  - j. Click **Submit**.
7. To create the next rule:
  - a. Click the policy created.
  - b. Click **+**.
  - c. Select **Access Control** option in the **Rule Type** field.
  - d. Click **OK**.
  - e. Select **Any** from the **Source** drop-down list.
  - f. Select **Any** from the **Destination** drop-down list.
  - g. Select **Service** from the **Service/app** drop-down list.
  - h. Select **Any** from the **Service alias** drop-down list.
  - i. Select **Route Source NAT** from the **Action** drop-down list.
8. Click **Submit**.



---

If you use a local DHCP server to obtain IP addresses, you must define one additional ACL to permit traffic between clients without source NATing the traffic. Add `user alias internal-network any permit before any any any route src-nat`.

---

9. In the **Managed Networks** node hierarchy, navigate to the **Configuration > Roles and Policies > Roles** tab.



---

Roles can be created only in the managed device.

---

10. Click **+** to create a new role.
11. Enter the role name in the **Name** field.
12. Click **Submit**.
13. Select the new role created.
14. Click **Show Advanced View**.
15. Click **+**.
16. Select an **Add existing policy** option and select the policy created from the **Policy name** drop-down list.
17. Click **Submit**.
18. Click **Pending Changes**.
19. In the **Pending Changes** window, select the check box and click **Deploy changes**.

### In the CLI

Use the following commands:

```
(host) [md] (config) #ip access-list session <policy>
    any any svc-dhcp permit
    any any any route src-nat
```

If you use a local DHCP server to obtain IP addresses, you must define one additional ACL to permit traffic between clients without source NATing the traffic. Add **user alias internal-network any permit before any any any route src-nat**:

```
(host) [md] (config) #user-role <role>
    session-acl <policy>
```

## Configuring the AAA Profile

### In the WebUI

1. In the **Managed Device** node hierarchy, navigate to the **Configuration > System > Profiles** tab.
2. Select **Wireless LAN > AAA** under **All Profiles**.
3. Click **+** in **AAA Profile**.
4. Enter the **Profile name**, and select the AAA profile that you just created:
  - a. For **Initial role**, select the user role you just created.
  - b. For **802.1X Authentication Default Role**, select the appropriate role (for example, "default") from the drop-down list.
  - c. Click **Save**.
  - d. Under the AAA profile that you created, locate **802.1X Authentication Server Group**, and select the Server Group to be used (for example "default") from the drop-down list.
  - e. Click **Save**.
5. Click **Pending Changes**.

6. In the **Pending Changes** window, select the check box and click **Deploy changes**.

### In the CLI

```
(host) [md] (config) #aaa profile default
(host) [md] (AAA Profile "default") #initial-role <role>
```

You can define other parameters as needed.

## Defining the Backup Configuration

### In the WebUI

1. In the **Mobility Master** node hierarchy, navigate to the **Configuration > System > Profiles** tab.
2. Select **Wireless LAN > Virtual AP** under **All Profiles**.
3. Click **+** in **Virtual AP profile** and enter the profile name.
4. Click **Save**.



---

Whenever you create a new virtual AP profile in the WebUI, the profile automatically contains the default SSID profile with the default ESSID. You must configure a new ESSID and SSID profile for the virtual AP profile before you apply the profile.

---

- a. Click **+** next to the profile created.
  - b. Click **AAA** and select a previously configured AAA profile from the **AAA Profile** drop-down list.
  - c. Click **Save**.
  - d. Click **SSID** and select the previously configured SSID profile from the **SSID Profile** drop-down list.
  - e. Click **Save**.
5. Select the new virtual AP name listed under **Wireless LAN > Virtual AP**, to view the configuration parameters.
  6. In the **General** accordion under **Virtual AP profile: name**, execute the following:
    - a. Ensure that the **Virtual AP enable** is selected.
    - b. Enter the VLAN ID to be used for the Virtual AP profile in the **VLAN** field.
    - c. Select **bridge** from the **Forward mode** drop-down list.
    - d. Click **Save**.
  7. Under **All Profiles**, select **AP > AP system** profile.
  8. Under **Profile Details**, execute the following:
    - a. Select the AP system profile that you want to edit.
    - b. Under the **LMS Settings** accordion, enter the LMS IP address in the **LMS IP** field.
    - c. Under the **Remote AP** accordion, enter the Remote -AP DHCP server name in the **Remote-AP DHCP Server** field.
    - d. Click **Save**.
  9. Click **Pending Changes**.
  10. In the **Pending Changes** window, select the check box and click **Deploy changes**.

### In the CLI

Use the following commands:

```
(host) [mynode] (config) #wlan ssid-profile <profile>
ssid <name>
opmode <method>
wpa-passphrase <string> (if necessary)
```

```
(host) [mynode] (config) #wlan virtual-ap <name>
ssid-profile <profile>
vlan <vlan>
forward-mode bridge
aaa-profile <name>
rap-operation {always|backup}

(host) [mynode] (config) #ap system-profile <name>
lms-ip <ipaddr>
master-ip <ipaddr>
rap-dhcp-default-router <ipaddr>

rap-dhcp-dns-server <ipaddr>
rap-dhcp-lease <days>
rap-dhcp-pool-end <ipaddr>
rap-dhcp-pool-netmask <netmask>
rap-dhcp-pool-start <ipaddr>
rap-dhcp-server-id <ipaddr>
rap-dhcp-server-vlan <vlan>

(host) [mynode] (config) #ap-group <name>
virtual-ap <name>
ap-system-profile <name>
```

or

```
(host) [mynode] (config) #ap-name <name>

virtual-ap <name>
ap-system-profile <name>
```

## Specifying the DNS Mobility Master Setting

In addition to specifying IP addresses for Mobility Master, you can also specify the master DNS name for the Mobility Master when provisioning the remote AP. The name must be resolved to an IP address when attempting to set up the IPsec tunnel. For information on how to configure a host name entry on the DNS server, refer to the vendor documentation for your server. It is recommended to use a maximum of 8 IP addresses to resolve a Mobility Master name.

If the remote AP gets multiple IP addresses responding to a host name lookup, the remote AP can use one of them to establish a connection to the Mobility Master. For more detailed information, see the next section [Backup Managed Device List on page 664](#).

Specifying the name also lets you move or change remote AP concentrators without reprovisioning your APs. For example, in a DNS load-balancing model, the host name resolves to a different IP address depending on the location of the user. This allows the remote AP to contact the Mobility Master to which it is geographically closest.

The DNS setting is part of provisioning the AP. The easiest way to provision an AP is to use the Provisioning page in the WebUI. These instructions assume you are only modifying the Mobility Master information in the Master Discovery section of the Provision page.




---

Reprovisioning the AP causes it to automatically reboot.

---

### In the WebUI

1. In the **Managed Device** node hierarchy, navigate to the **Configuration > Access Points > Remote APs** tab.
2. Select the remote AP and click **Provision**.

3. In the **General** tab, enter master DNS name in the **Controller IP/DNS name** field.
4. Click **Submit**.
5. Click **Pending Changes**.
6. In the **Pending Changes** window, select the check box and click **Deploy changes**.

For more information, see [Provision the AP on page 645](#).

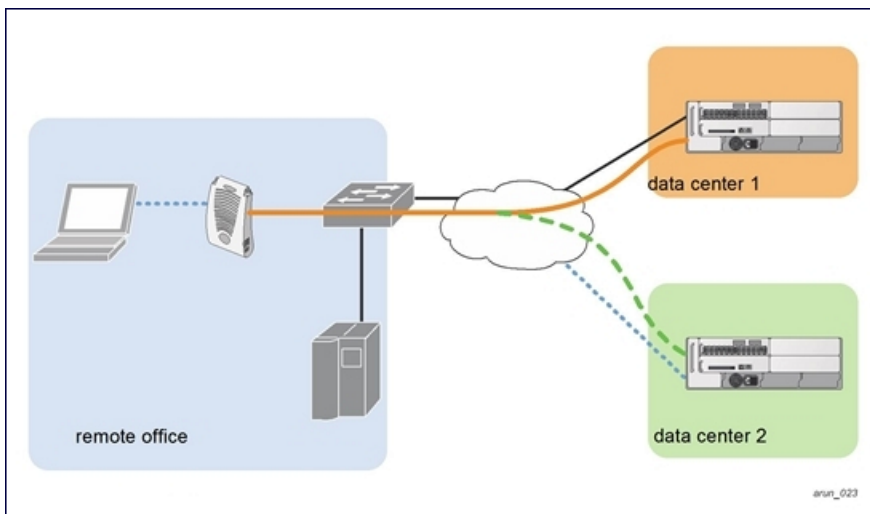
## Backup Managed Device List

Using DNS, the remote AP receives multiple IP addresses in response to a host name lookup. Known as the backup managed device list, remote APs go through this list to associate with a managed device. If the primary managed device is unavailable or does not respond, the remote AP continues through the list until it finds an available managed device. This provides redundancy and failover protection.

The remote AP loses the IP address information received through DNS when it terminates and receives the system profile configuration from the managed device. If the remote AP loses connectivity on the IPsec tunnel to the managed device, the RAP fails over from the primary managed device to the backup managed device. For this scenario, add the IP address of the backup managed device in the backup LMS and the IP address of the primary managed device in the LMS field of the ap-system profile. Network connectivity is lost during this time. As described in the section [Configuring Remote AP Failback on page 665](#), you can also configure a remote AP to revert back to the primary managed device when it becomes available. To complete this scenario, you must also configure the LMS IP address and the backup LMS IP address.

For example, assume you have two data centers, data center 1 and data center 2, and each data center has one master managed device in the DMZ. You can provision the remote APs to use the managed device in data center 1 as the primary managed device, and the managed device in data center 2 as the backup managed device. If the remote AP loses connectivity to the primary, it will attempt to establish connectivity to the backup. You define the LMS parameters in the AP system profile.

**Figure 49** Sample Backup Scenario



## Configuring the LMS and backup LMS IP addresses

### In the WebUI

1. In the **Managed Device** node hierarchy, navigate to the **Configuration > System > Profiles** tab.
2. Select **AP > AP system** under **All Profiles**.
3. Select the AP system profile you want to modify.
4. Enter the following details in the **LMS Settings** accordion:



- a. Enter the primary managed device IP address, in the **LMS IP** field.
  - b. Enter the backup managed device IP address, in the **Backup LMS IP** field.
5. Click **Save**.
  6. Click **Pending Changes**.
  7. In the **Pending Changes** window, select the check box and click **Deploy changes**.

#### In the CLI

```
(host) [md] (config) #ap system-profile <profile>
lms-ip <ipaddr>
bkup-lms-ip <ipaddr>
```

```
(host) [md] (config) #ap-group <group>
ap-system-profile <profile>
```

```
(host) [md] (config) #ap-name <name>
ap-system-profile <profile>
```

## Configuring Remote AP Failback

In conjunction with the backup managed device list, you can configure remote APs to revert back (failback) to the primary managed device if it becomes available. If you do not explicitly configure this behavior, the remote AP will keep its connection with the backup managed device until the remote AP, managed device, or both have rebooted or some type of network failure occurs. If any of these events occur, the remote AP will go through the backup managed device list and attempt to connect with the primary managed device.

#### In the WebUI

1. In the **Managed Device** node hierarchy, navigate to the **Configuration > System > Profiles** tab.
2. Select **AP > AP system** under **All Profiles**.
3. Select the AP system profile you want to modify.
4. Enter the following details in the **LMS Settings** accordion:
  - a. Select the **LMS Preemption** check box. This is disabled by default.
  - b. Enter the duration (in seconds) for which the remote AP must wait before moving back to the primary managed device, in the **LMS Hold-down period** field.
5. Click **Save**.
6. Click **Pending Changes**.
7. In the **Pending Changes** window, select the check box and click **Deploy changes**.

#### In the CLI

Use the following commands:

```
(host) [md] (config) #ap system-profile <profile>
lms-preemption
lms-hold-down period <seconds>
```

## Enabling RAP Local Network Access

You can enable local network access between the clients (from same or different subnets and VLANs) connected to a RAP through wired or wireless interfaces in split-tunnel/bridge forwarding modes. This allows the clients to effectively communicate with each other without routing the traffic via the managed device. You can use WebUI or CLI to enable the local network access.

## In the WebUI

1. In the **Managed Device** node hierarchy, navigate to the **Configuration > System > Profiles** tab.
2. Select **AP > AP system** under **All Profiles**.
3. Select the AP system profile you want to modify.
4. To enable remote network access, select the **Remote-AP Local Network Access** check box under the **Remote AP** accordion.
5. Click **Save**.
6. Click **Pending Changes**.
7. In the **Pending Changes** window, select the check box and click **Deploy changes**.

## In the CLI

- To enable, enter the following command:  

```
(host) [md] (config) #ap system-profile <ap-profile> rap-local-network-access
```
- To disable, enter the following command:  

```
(host) [md] (config) #ap system-profile <ap-profile> no rap-local-network-access
```

See the *ArubaOS CLI Reference Guide* for detailed information on the command options.

## Configuring Remote AP Authorization Profiles

Remote AP configurations include an authorization profile that specifies which profile settings should be assigned to a remote AP that has been provisioned but not yet authenticated at the remote site. These yet-unauthorized APs are put into the temporary AP group **authorization-group** by default and assigned the predefined profile **NoAuthApGroup**. This configuration allows the user to connect to an unauthorized remote AP via a wired port, then enter a corporate username and password. Once a valid user has authorized the AP, and it will be marked as authorized on the network. The remote AP will then download the configuration assigned to that AP by its permanent AP group.

## In the WebUI

### Adding or Editing a Remote AP Authorization Profile

To create a new authorization profile or edit an existing authorization profile via the WebUI:

1. In the **Managed Device** node hierarchy, navigate to the **Configuration > System > Profiles** tab.
2. Select **AP > AP Authorization** under **All Profiles**.
  - a. To edit an existing profile, select a profile listed under **AP Authorization** profile and select a new AP authorization group from the **AP authorization group** drop-down list.
  - b. To create a new authorization profile, click **+** next to the **AP Authorization profile** field.
    - Enter the name in the **Profile name** field.
    - Select a group from the **AP authorization group** drop-down list.
3. Click **Save**.
4. Click **Pending Changes**.
5. In the **Pending Changes** window, select the check box and click **Deploy changes**.

## In the CLI

To create a new authorization profile or edit an existing authorization profile via the command-line interface, access the command-line interface in enable mode, and issue the following commands.

```
(host) [md] (config) #ap authorization-profile <profile>
authorization-group <ap-group>
```

## Working with Access Control Lists and Firewall Policies

Remote APs support the following access control lists (ACLs); unless otherwise noted, you apply these ACLs to user roles:

- Standard ACLs—Permit or deny traffic based on the source IP address of the packet.
- Ethertype ACLs—Filter traffic based on the Ethertype field in the frame header.
- MAC ACLs—Filter traffic on a specific source MAC address or range of MAC addresses.
- Firewall policies (session ACLs)—Identifies specific characteristics about a data packet passing through the Aruba Mobility Master and takes some action based on that identification. You apply these ACLs to user roles or uplink ports.



---

To configure firewall policies, you must install the PEFNG license.

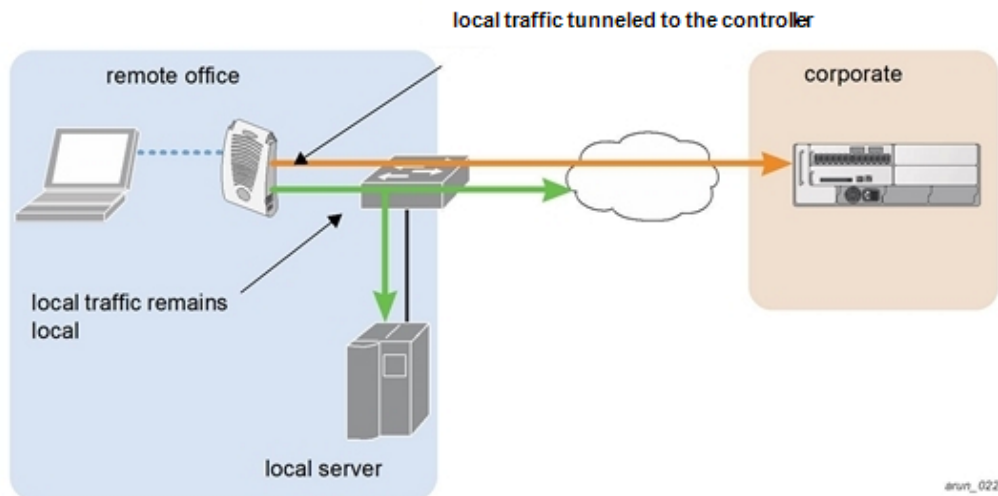
---

For more information about ACLs and firewall policies, see [Configuring Fallback Mode on page 656](#).

## Understanding Split Tunneling

The split tunneling feature allows you to optimize traffic flow by directing only corporate traffic back to the Mobility Master, while local application traffic remains local. This ensures that local traffic does not incur the overhead of the round trip to the Mobility Master, which decreases traffic on the WAN link and minimizes latency for local application traffic. This is useful for sites that have local servers and printers. With split tunneling, a remote user associates with a single SSID, not multiple SSIDs, to access corporate resources (for example, a mail server) and local resources (for example, a local printer). The remote AP examines session ACLs to distinguish between corporate traffic destined for the Mobility Master and local traffic.

**Figure 50** Sample Split Tunnel Environment



[Figure 50](#) displays corporate traffic is GRE tunneled to the Mobility Master through a trusted tunnel and local traffic is source NATed and bridged on the wired interface based on the configured user role and session ACL.

## Configuring Split Tunneling

The procedure to configure split tunneling requires the following steps. Each step is described in detail later in this chapter.



---

The split tunneling feature requires the PEFNG license. If you do not have the PEFNG license on your Mobility Master, you must install it before you configure split tunneling. For details on installing licenses, refer to the *Aruba Mobility Master Licensing Guide*.

---

1. Define a session ACL that forwards only corporate traffic to the Mobility Master.
  - a. Configure a net destination for the corporate subnets.
  - b. Create rules to permit DHCP and corporate traffic to the corporate Mobility Master.
  - c. Apply the session ACL to a user role.
2. (Optional) Configure an ACL that restricts remote AP users from accessing the remote AP local debugging homepage.
3. Configure the remote AP's AAA profile.
  - a. Specify the authentication method (**802.1X** or **PSK**) and the default user role for authenticated users. The user role specified in the AAA profile must contain the session ACL defined in the previous step.
  - b. (Optional) Use the remote AP's AAA profile to enable RADIUS accounting.
4. Configure the virtual AP profile:
  - a. Specify which AP group or AP to which the virtual AP profile applies.
  - b. Set the VLAN used for split tunneling. Only one VLAN can be configured for split tunneling; VLAN pooling is not allowed.
  - c. When specifying the use of a split tunnel configuration, use "split-tunnel" forward mode.
  - d. Create and apply the applicable SSID profile.



---

When creating a new virtual AP profile in the WebUI, you can also configure the SSID at the same time. For information about AP profiles, see [Understanding AP Configuration Profiles on page 502](#).

---

5. (Optional) Create a list of network names resolved by corporate DNS servers.

## Configuring the Session ACL Allowing Tunneling

First you need to configure a session ACL that "permits" corporate traffic to be forwarded (tunneled) to the Mobility Master, and that routes, or locally bridges, local traffic.



---

Roles can be created only in the managed device.

---

### In the WebUI

1. In the **Managed Device** node hierarchy, navigate to the **Configuration > Roles and Policies > Policies** tab.
2. Click **+** to create a new policy.
3. Enter the policy name in the **Policy Name** field.
4. From the **Policy Type** drop-down list, select **Session**.
5. Click **Submit**.
6. To create the first rule:
  - a. Select the policy created.
  - b. Click **+** in the **Policies > <policy name>** table.
  - c. Select the **Rule Type** in the **New Rule for <policy name>** dialog box.
  - d. Click **OK**.
7. Enter the following details in the **Roles > <policy name> > <rule name>** table:

- e. From the **IP version** drop-down list, select **IPv4** or **IPv6**.
  - f. Select **Any** from the **Source** drop-down list.
  - g. Select **Any** from the **Destination** drop-down list.
  - h. Select **Service** from the **Service/app** drop-down list.
  - i. Select **svc-dhcp** from the **Service alias** drop-down list.
  - j. Select **Permit** from the **Action** drop-down list.
  - k. Click **Submit**.
8. To create the next rule:
- a. Click the policy created.
  - b. Click **+**.
  - c. Select the **Rule Type** in the **New Rule for <policy name>** dialog box and click **OK**.
  - d. From the **IP version** drop-down list, select **IPv4** or **IPv6**.
  - e. Select **Any** from the **Source** drop-down list.
  - f. Select **Alias** from the **Destination** drop-down list.
 

The following steps define an alias representing the corporate network. Once defined, you can use the alias for other rules and policies. You can also create multiple destinations the same way.
9. Select **+** from the **Destination alias** drop-down list.
- a. From the **IP version** drop-down list, select **IPv4** or **IPv6**.
  - b. Enter a name in the **Destination name** field.
  - c. Click **+** under **Rule** and select **Network** from the **Rule type** drop-down list.
  - d. Enter the public IP address of the Managed Device in the **IP address** field.
  - e. Enter the Network mask/range in the **Network mask** field.
  - f. Click **OK**.
 

The new alias appears in the **Destination alias** drop-down list.
10. Under **Destination alias**, select the alias you just created.
11. Select **Permit** from the **Action** drop-down list.
12. Click **Submit**.
13. In the **Managed Networks** node hierarchy, navigate to the **Configuration > Roles and Policies > Roles** tab.




---

Roles can be created only in the managed device.

---

14. Click **+** to create a new role.
15. Enter the role name in the **Name** field.
16. Click **Submit**.
17. Click the new role created.
18. Click **Show Advanced View**.
19. Click **+**.
20. Select **Add existing session policy** option and select the policy created from the **Policy name** drop-down list.
21. Click **Submit**.
22. Click **Pending Changes**.
23. In the **Pending Changes** window, select the check box and click **Deploy changes**.

## In the CLI

```
(host) [md] (config) #ap system-profile <profile>
lms-preemption
lms-hold-down period <seconds>netdestination <policy>
network <ipaddr> <netmask>
```

```
(host) [md] (config) #ip access-list session <policy>
any any svc-dhcp permit
any alias <name> any permit
user any any route src-nat
```

```
(host) [md] (config) #user-role <role>
session-acl <policy>
```

When defining the alias, there are a number of other session ACLs that you can create to define the handling of local traffic, such as:

```
(host) [md] (config) #ip access-list session <policy>
user alias <name> any redirect 0
```

```
user alias <name> any route
```

```
user alias <name> any route src-nat
```

## Configuring an ACL to Restrict Local Debug Homepage Access

A user in split or bridge role using a remote AP (RAP) can log on to the local debug (LD) homepage (for example, <http://rapconsole.arubanetworks.com>) and perform a reboot or reset operations. The LD homepage provides various information about the RAP and also has a button to reboot the RAP. You can now restrict a RAP user from resetting or rebooting a RAP by using the **localip** keyword in the in the user role ACL.



---

You will require the PEFNG license to use this feature. For complete information on the centralized licensing requirements, refer to the *Aruba Mobility Master Licensing Guide*.

---

Any user associated to that role can be allowed or denied access to the LD homepage. You can use the `localip` keyword in the ACL rule to identify the local IP address on the RAP. The `localip` keyword identifies the set of all local IP addresses on the system to which the ACL is applied. The existing keywords `Mobility Master` and `mswitch` indicate only the primary IP address on the Mobility Master.



---

This release of ArubaOS provides `localip` keyword support only for RAP and not for Mobility Master.

---

## In the WebUI

1. In the **Managed Device** node hierarchy, navigate to the **Configuration > Roles and Policies > Policies** tab.
2. Click **+** to create a new policy.
3. Enter the policy name in the **Policy Name** field.
4. From the **Policy Type** drop-down list, select **Session**.
5. Click **Submit**.
6. To create the first rule:
  - a. Select the policy created.
  - b. Click **+** in the **Policies > <policy name>** table.
  - c. Select the **Rule Type** in the **New Rule for <policy name>** dialog box.

- d. Click **OK**.
7. Enter the following details in the **Roles > <policy name> > <rule name>** table:
  - e. From the **IP version** drop-down list, select **IPv4** or **IPv6**.
  - f. Select **Any** from the **Source** drop-down list.
  - g. Select **Any** from the **Destination** drop-down list.
  - h. Select **Service** from the **Service/app** drop-down list.
  - i. Select **svc-dhcp** from the **Service alias** drop-down list.
  - j. Select **Permit** from the **Action** drop-down list.
  - k. Click **Submit**.
8. Click **Pending Changes**.
9. In the **Pending Changes** window, select the check box and click **Deploy changes**.

### In the CLI

Use the `localip` keyword in the user role ACL.

All users have an ACL entry of type `any any deny` by default. This rule restricts access to all users. When the ACL is configured for a user role, if a `user any permit` ACL rule is configured, add a deny ACL before that for `localip` for restricting the user from accessing the LD homepage.

Example:

```
(host) [md] (config) #ip access-list session logon-control
user localip svc-http deny
user any permit
```

### Configuring the AAA Profile for Tunneling

After you configure the session ACL, you define the AAA profile used for split tunneling. When defining the AAA parameters, specify the previously configured user role that contains the session ACL used for split tunneling.

If you enable RADIUS accounting in the AAA profile, the Mobility Master sends a RADIUS accounting start record to the RADIUS server when a user associates with the remote AP, and sends a stop record when the user logs out or is deleted from the user database. If you enable interim accounting, the Mobility Master sends updates at regular intervals. Each interim record includes cumulative user statistics, including received bytes and packets counters. For more information on RADIUS accounting, see [RADIUS Accounting on page 198](#)

### In the WebUI

1. In the **Managed Device** node hierarchy, navigate to the **Configuration > System > Profiles** tab.
2. Select **Wireless LAN >AAA** under **All Profiles**.
3. Click **+** in **AAA Profile** and enter the following details:
  - a. Enter the **Profile name**.
  - b. For **Initial role**, select the appropriate role (for example, "logon") from the drop-down list.
  - c. For **802.1X Authentication Default Role**, select the appropriate role (for example, "default") from the drop-down list.
  - d. Click **Save**.
  - e. Under the AAA profile that you created, locate **802.1X Authentication Server Group**, and select the Server Group to be used (for example "default") from the drop-down list.
  - f. Click **Save**.
4. (Optional) To enable RADIUS accounting:

- a. Select the AAA profile from the profile list to display the list of authentication and accounting profiles associated with the AAA profile.
- b. Select the **Radius Accounting Server Group** profile associated with the AAA profile. Click the **Server Group** drop-down list to select a RADIUS server group. (For more information on configuring a RADIUS server or server group, see [Configuring a RADIUS Server on page 182.](#))
5. Click **Save**.
6. Click **Pending Changes**.
7. In the **Pending Changes** window, select the check box and click **Deploy changes**.

### In the CLI

```
(host) [md] (config) #aaa profile <name>
authentication-dot1x <dot1x-profile>
dot1x-default-role <role>
dot1x-server-group <group>
radius-accounting <group>
radius-interim-accounting
```

## Configuring the Virtual AP Profile

### In the WebUI

1. In the **Managed Device** node hierarchy, navigate to **Configuration > System > Profiles** tab.
2. Select **Wireless LAN > Virtual AP** under **All Profiles**.
3. To create a new virtual AP profile, click **+** in **Virtual AP profile**. Enter the name for the virtual AP profile, and click **Save**.




---

Whenever you create a new virtual AP profile in the WebUI, the profile automatically contains the “default” SSID profile with the default ESSID. You must configure a new ESSID and SSID profile for the virtual AP profile before you apply the profile.

---

- a. Select **Wireless LAN > SSID** under **All Profiles**.
- b. Click **+** in **SSID Profile** and enter the following details:
  - Enter the name of the profile in the **Profile name** field.
  - To enable SSID, select the **SSID enable** check box.
  - Select the appropriate check box under the **Encryption** field, to choose the network authentication and encryption method.
- c. Click **Save**.
4. Select the new virtual AP name listed under **Wireless LAN > Virtual AP**, to view the configuration parameters.
5. In the **General** accordion under **Virtual AP profile: name**, execute the following:
  - a. Ensure that the **Virtual AP enable** is selected.
  - b. Enter the VLAN ID to be used for the Virtual AP profile in the **VLAN** field.
  - c. Select **split-tunnel** from the **Forward mode** drop-down list.
  - d. Click **Save**.
6. Under **All Profiles**, select **AP > AP system** profile.
7. Select the AP system profile that you want to edit.
  - a. Under the **LMS Settings** accordion, enter the LMS IP address in the **LMS IP** field.
  - b. Under the **Remote AP** accordion, click **+** under **REMOTE-AP DHCP DNS SERVER** and enter the Remote - AP DHCP DNS server in the **Remote-AP DHCP DNS Server** field.



- c. Click **OK**.
  - d. Click **Save**.
8. Click **Pending Changes**.
  9. In the **Pending Changes** window, select the check box and click **Deploy changes**.

### In the CLI

```
(host) [md] (config) #wlan ssid-profile <profile>
ssid <name>
opmode <method>
```

```
(host) [md] (config) #wlan virtual-ap <profile>
ssid-profile <name>
forward-mode <mode>
```

```
(host) [md] (config) # vlan <vlan id>
aaa-profile <profile>
```

```
(host) [md] (config) #ap-group <name>
virtual-ap <profile>
```

or

```
(host) [md] (config) #ap-name <name>
virtual-ap <profile>
```

## Defining Corporate DNS Servers

Clients send DNS requests to the corporate DNS server address that it learned from DHCP. If configured for split tunneling, corporate domains and traffic destined for corporate use the corporate DNS server. For non-corporate domains and local traffic, other DNS servers can be used.

### In the WebUI

1. In the **Managed Device** node hierarchy, navigate to **Configuration > System > Profiles** tab.
2. Select **AP > AP system** under **All Profiles**.
3. Select an AP System Profile.
4. Click **+** under **CORPORATE DNS DOMAIN** table and enter the **Corporate DNS Domain**.
5. Click **OK**. The DNS name appears in **Corporate DNS Domain** table. You can add multiple names the same way.
6. Click **Save**.
7. Click **Pending Changes**.
8. In the **Pending Changes** window, select the check box and click **Deploy changes**.

### In the CLI

```
(host) [md] (config) #ap system-profile <profile>
dns-domain <domain name>
```

## Understanding Bridge

The bridge feature allows you to route the traffic flow only to the internet and not to the corporate network. Only the 802.1X authentication request is sent to the corporate network. This feature is useful for guest users.




---

ArubaOS does not support Wired 802.1X authentication in bridge mode for RAP and CAP. 802.1X authentication is supported only in tunnel and split modes.

---

**Figure 51** Sample Bridge Environment

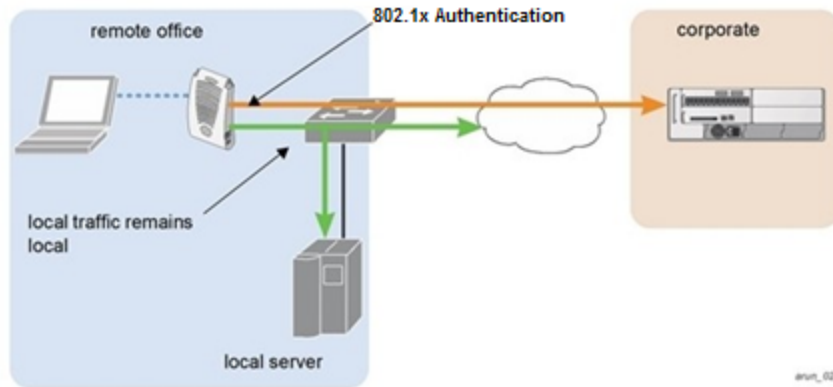


Figure 51 displays the local traffic being routed to the internet and the 802.1X authentication request sent to the corporate network.

## Configuring Bridge

To configure a bridge, perform the following steps. Each step is described in detail later in this chapter.



---

The bridge feature requires the PEFNG license. If you do not have the PEFNG license on your managed device, you must install it before you configure bridge. For details on installing licenses, refer to the *Aruba Mobility Master Licensing Guide*.

---

1. Define a session ACL that routes the traffic.
  - a. Create rules to permit DHCP and local data traffic.
  - b. Apply the session ACL to a user role. For information about user roles and policies, see [Roles and Policies on page 367](#).
2. Configure the remote AP's AAA profile. Specify the authentication method (**802.1X** or **PSK**) and the default user role for authenticated users. The user role specified in the AAA profile must contain the session ACL defined in the previous step. Optionally, use the remote AP's AAA profile to enable RADIUS accounting.
3. Configure the virtual AP profile:
  - a. Specify the AP group or ap-name to which the virtual AP profile applies.
  - b. Set the VLAN in the virtual AP.
  - c. When specifying the use of a bridge configuration, use bridge forward mode.
  - d. Create and apply the applicable SSID profile. Optionally under AP system profile, configure the RAP DHCP pool. RAP DHCP VLAN must be same as virtual AP's VLAN. If the client needs to obtain from the RAP DHCP Server.



---

When creating a new virtual AP profile in the WebUI, you can simultaneously configure the SSID. For information about AP profiles, see [Understanding AP Configuration Profiles on page 502](#).

---

## Configuring the Session ACL

First you need to configure a session ACL that “permits” corporate traffic to be forwarded to the managed device and that routes, or locally bridges, local traffic.

### In the WebUI

1. In the **Managed Device** node hierarchy, navigate to the **Configuration > Roles and Policies > Policies** tab.

2. Click **+** to create a new policy.
3. Enter the name in the **Policy name** field.
4. Select **Session** from the **Policy type** drop-down list.
5. Click **Submit**.
6. Select the policy created and click **+** under **Policies <policy name>** table.
7. Select **Access Control** option in the **Rule Type** field.
8. Click **OK**.
9. To complete creating the rule:
  - a. Select **IPv4** or **IPv6**, from the **IP version** drop-down list.
  - b. Select **Any** from the **Source** drop-down list.
  - c. Select **Any** from the **Destination** drop-down list.
  - d. Select **Service** from the **Service/app** drop-down list.
  - e. Select **svc-dhcp** from the **Service alias** drop-down list.
  - f. Select **Permit** for IPv4 or **Captive** for IPv6 from the **Action** drop-down list.
  - g. Click **Submit**.
10. To create a new forwarding rule:
  - a. Select policy created and click **+** in the **Policies <policy name>** table.
  - b. Select **Access Control** option in the **Rule Type** field.
  - c. Click **OK**.
  - d. Select **IPv4** or **IPv6**, from the **IP version** drop-down list.
  - e. Select **any** from the **Source** drop-down list.
  - f. Select **alias** from the **Destination** drop-down list.
  - g. Click **+** in the **Destination alias** drop-down list.
  - h. In the **Add New Destination** window, click **+** in the **Rule** table.
  - i. Select **Network** from the **Rule type** drop-down list.
  - j. Enter the public IP address of the managed device in the **IP address** field.
  - k. Enter the Netmask/range in the **Network mask** field.
  - l. Click **OK**. The new alias appears in the **Destination alias** drop-down list.
  - m. Click **Submit**.
11. Navigate to the **Configuration > Roles and Policies > Roles** tab.




---

Roles can be created only in the managed device.

---

- a. Click **+** to create a new role.
  - b. Enter the role name in the **Name** field.
  - c. Click **Submit**.
  - d. Click the new role created.
  - e. Click **Show Advanced View**.
  - f. Click **+**.
  - g. Select **Add an existing policy** option and select the policy created from the **Policy name** drop-down list.
  - h. Click **Submit**.
12. Click **Pending Changes**.

13. In the **Pending Changes** window, select the check box and click **Deploy changes**.

### In the CLI

If dhcp server in ap system profile is enabled:

```
(host) [md] (config) #ip access-list session <policy> any any svc-dhcp permit
(host) [md] (config) #user any any route src-nat
```

If dhcp server in ap system profile is disabled:

```
(host) [md] (config) #ip access-list session <policy>
(host) [md] (config) #any any any permit
(host) [md] (config) #user-role <role>
(host) [md] (config) #session-acl <policy>
```



---

To configure an ACL to Restrict Local Debug Homepage Access, see [Configuring an ACL to Restrict Local Debug Homepage Access on page 670](#).

---

## Configuring the AAA Profile for Bridge

After you configure the session ACL, define the AAA profile used for bridge. When defining the AAA parameters, specify the previously configured user role that contains the session ACL used for bridge.

If you enable RADIUS accounting in the AAA profile, the Mobility Master sends a RADIUS accounting start record to the RADIUS server when a user associates with the remote AP, and sends a stop record when the user logs out or is deleted from the user database. If you enable interim accounting, the Mobility Master sends updates at regular intervals. Each interim record includes cumulative user statistics, including received bytes and packets counters. For more information on RADIUS accounting, see [RADIUS Accounting on page 198](#).

### In the WebUI

1. In the **Mobility Master** node hierarchy, navigate to the **Configuration > System > Profiles** tab.
2. Select **Wireless LAN > AAA** under **All Profiles**.
3. Click + in **AAA Profile**.
4. Enter the **Profile name**.
5. Select the appropriate role (for example, "logon") from the **Initial role** drop-down list.
6. Select the user role you previously configured for split tunneling or bridge from the **802.1X Authentication Default Role** drop-down list.
7. Click **Save**.
8. Select the AAA profile created and locate the **802.1X Authentication Server Group**, and select the **Server Group** to be used (for example "default") from the drop-down list.
9. Click **Save**.
10. Click **Pending Changes**.
11. In the **Pending Changes** window, select the check box and click **Deploy changes**.

### In the CLI

```
(host) [mynode] (config) #aaa profile <name>
(host) [mynode] (config) #authentication-dot1x <dot1x-profile>
(host) [mynode] (config) #dot1x-default-role <role>
(host) [mynode] (config) #dot1x-server-group <group>
(host) [mynode] (config) #radius-accounting <group>
(host) [mynode] (config) #radius-interim-accounting
```

# Configuring Virtual AP Profile

## In the WebUI

1. In the **Mobility Master** node hierarchy, navigate to the **Configuration > System > Profiles** tab.
2. Select **Wireless LAN > Virtual AP** under **All Profiles**.
3. To create a new virtual AP profile, click + in **Virtual AP profile**. Enter the name for the virtual AP profile, and click **Save**.



---

Whenever you create a new virtual AP profile in the WebUI, the profile automatically contains the “default” SSID profile with the default ESSID. You must configure a new ESSID and SSID profile for the virtual AP profile before you apply the profile.

---

- a. Select **Wireless LAN > SSID** under **All Profiles**.
  - b. Click + in **SSID Profile** and enter the following details:
    - Enter the name of the profile in the **Profile name** field.
    - To enable SSID, select the **SSID enable** check box.
    - Select the appropriate check box under the **Encryption** field, to choose the network authentication and encryption method.
  - c. Click **Save**.
4. Select the new virtual AP name listed under **Wireless LAN > Virtual AP**, to view the configuration parameters.
  5. In the **General** accordion under **Virtual AP profile: name**, execute the following:
    - a. Ensure that the **Virtual AP enable** check box is selected.
    - b. Enter the VLAN ID to be used for the Virtual AP profile in the **VLAN** field.
    - c. Select **Bridge** from the **Forward mode** drop-down list.
    - d. Click **Save**.
  6. Under **All Profiles**, select **AP > AP system** profile.
  7. Select the AP system profile that you want to edit.
    - a. Under the **LMS Settings** accordion, enter the LMS IP address in the **LMS IP** field.
    - b. Under the **Remote AP** accordion, click + under **REMOTE-AP DHCP DNS SERVER** and enter the Remote - AP DHCP DNS server in the **Remote-AP DHCP DNS Server** field.
    - c. Click **OK**.
    - d. Click **Save**.
  8. Click **Pending Changes**.
  9. In the **Pending Changes** window, select the check box and click **Deploy changes**.

## In the CLI

```
(host) [mynode] (config) #wlan ssid-profile <profile> essid <name>
(host) [mynode] (config) #opmode <method>

(host) [mynode] (config) #wlan virtual-ap <profile>
(host) [mynode] (config) #ssid-profile <name>
(host) [mynode] (config) #forward-mode bridge
(host) [mynode] (config) #vlan <vlan id>
(host) [mynode] (config) #aaa-profile <profile>

(host) [mynode] (config) #ap-group <name>
(host) [mynode] (config) #virtual-ap <profile>
```

or

```
(host) [mynode] (config) #ap-name <name>
(host) [mynode] (config) #virtual-ap <profile>
```

## Provisioning Wi-Fi Multimedia

Wi-Fi Multimedia (WMM) is a Wi-Fi Alliance specification based on the IEEE 802.11e wireless Quality of Service (QoS) standard. WMM works with 802.11a, b, g, and n physical layer standards. The IEEE 802.11e standard also defines the mapping between WMM access categories and Differentiated Services Codepoint (DSCP) tags. Remote APs support WMM.

WMM supports four access categories: voice, video, best effort, and background. You apply and configure WMM in the SSID profile.

When planning your configuration, make sure that immediate switches or routers do not have conflicting 802.1p or DSCP configurations/mappings. If this happens, your traffic may not be prioritized correctly.

## Reserving Uplink Bandwidth

You can reserve and prioritize uplink bandwidth traffic to provide higher QoS for specific applications, traffic, or ports. This is done by applying bandwidth reservation on existing session Access Control Lists (ACL)s. Typically, the bandwidth reservation is applied for uplink voice traffic.

Note the following before you configure bandwidth reservation:

- You must know the total bandwidth available.
- Bandwidth reservation is applicable only on session ACLs.
- Bandwidth reservation on voice traffic ACLs receives higher priority over other reserved traffic.
- You can configure up to three unique priority for bandwidth reservation.
- The bandwidth reservation must be specified in absolute value (kbps).
- Priorities for bandwidth reservation are optional, and bandwidth reservations without priorities are treated equal.

## Understanding Bandwidth Reservation for Uplink Voice Traffic

Voice ACLs are applicable on the voice signaling traffic used to establish a voice call through a firewall. When a voice ACL is executed, a dynamic session is introduced to allow voice traffic through the firewall. This prevents the re-use of voice ACLs for bandwidth reservation. However, you can create bandwidth reservation rules that can be applied on voice signaling traffic and ports used for voice data traffic. This mechanism filters traffic as per the security requirements.

## Configuring Bandwidth Reservation

You can configure bandwidth reservation ACLs using the WebUI or the CLI.

### In the WebUI

Follow the steps below to configure bandwidth reservation:

1. In the **Mobility Master** node hierarchy, navigate to the **Configuration > System > Profiles** tab.
2. Click **AP** and select **AP system**.
3. Click **Remote AP** accordion. You can create a new AP system profile to configure bandwidth reservation or edit an existing AP system profile. In **Remote-AP bw reservation 1**, **Remote-AP bw reservation 2** and **Remote-AP bw reservation 3** fields, specify bandwidth reservation values.

4. Click **Save**.
5. Click **Pending Changes**.
6. In the **Pending Changes** window, select the check box and click **Deploy changes**.

### In the CLI

```
(host) [mynode] (config)#ap system-profile remotebw
(host) [mynode] (AP system profile "remotebw") #rap-bw-total 1024
(host) [mynode] (AP system profile "remotebw") #rap-bw-resv-1 acl voice 128 priority 1
```

To view bandwidth reservations:

```
(host) [mynode] #show datapath rap-bw-resv ap-name remote-ap-1
```

## Provisioning 4G USB Modems on Remote Access Points

ArubaOS provides support for 4G networks by allowing you to provision 4G USB modems on the RAP. You can also provision the RAP to support both 4G and 3G USB modems. This enables the RAP to choose the available network automatically. 4G takes precedence over 3G when the RAP tries to auto select the network. You can also configure the RAP to work exclusively on a 3G or 4G network. It is recommended that you provision the USB modems for the RAP based on your network requirements.

### 4G USB Modem Provisioning Best Practices and Exceptions

- RAP does not support dynamic plug-and-play for the 4G USB modems. You must provision a RAP with the 4G USB parameters on the managed device manually based on its type and family (4G-WiMAX/4G-LTE).
- When a RAP connects to a 4G network, it appears as a Remote AP (R) and Cellular (C) on the managed device.
- For a 3G/4G network switch, using the UML290 modem with the firmware version L0290VWB522F.242 or later is recommended. Using a lower version of the firmware auto-selects the network mode based on the network availability. The latest version allows the RAP to lock the modem in a particular network mode (for example, 3G only).



---

The 4G-WiMAX family of modems do not support the 3G-4G network switch-over functionality.

---

A new method of provisioning multimode USB modems (such as a Verizon UML290, Verizon MC551L, or AT&T 313u) for a RAP has been introduced. These changes simplify modem provisioning for both 3G and 4G networks. Earlier the modem configuration procedure required that you define a driver for a 3G modem in the USB modem field under the AP provisioning profile, or define a driver for a 4G modem in the 4G USB type field. You can now configure drivers for both a 3G or a 4G modem using the USB field, and the 4G USB Type field is deprecated.

### Provisioning RAP for USB Modems

To enable 3G/4G network support, you must provision the RAP with the USB parameters on the managed device. You can use the WebUI or CLI to provision the USB parameters.

#### In the WebUI

1. In the **Managed Device** node hierarchy, navigate to the **Configuration > Access Points > Remote APs** tab.
2. Select the remote AP and click **Provision**.
3. Select **Uplink** tab. This tab is displayed only when one RAP is selected.

4. Select a profile from the **USB Profile** drop-down list. This field is displayed only when the device is USB enabled.
5. Click **Submit**.
6. Click **Pending Changes**.
7. In the **Pending Changes** window, select the check box and click **Deploy changes**.

**Table 133:** Cellular Network Preference Parameters

Parameter	Description
auto (default)	In this mode, the modem firmware will control the cellular network service selection; so the cellular network service failover and fallback is not interrupted by the RAP.
3g_only	Locks the modem to operate only in 3G.
4g_only	Locks the modem to operate only in 4G.
advanced	<p>The RAP controls the cellular network service selection based on an Received Signal Strength Indication (RSSI) threshold-based approach.</p> <ul style="list-style-type: none"> <li>• Initially the modem is set to the default auto mode. This allows the modem firmware to select the available network.</li> <li>• The RAP determines the RSSI value for the available network type (for example 4G), checks whether the RSSI is within required range, and if so, connects to that network.</li> <li>• If the RSSI for the modem's selected network is not within the required range, the RAP will then check the RSSI limit of an alternate network (for example, 3G), and reconnect to that alternate network. The RAP will repeat the above steps each time it tries to connect using a 4G multimode modem in this mode.</li> </ul>

### In the CLI

To enable 4G-exclusive network support on the RAP, execute the following commands:

```
(host) [md] (config) #ap provisioning-profile <profile-name>
(host) [md] (Provisioning profile "<profile-name>") usb-type <USB modem type>
(host) [md] (Provisioning profile "<profile-name>") #usb-type none

(host) [md] (Provisioning profile "<profile-name>") #cellular_nw_preference 4g_only
```

To enable 3G-exclusive network support on the RAP, execute the following commands:

```
(host) [md] (config) #ap provisioning-profile <profile-name>
(host) [md] (Provisioning profile "<profile-name>") usb-type <USB modem type>
(host) [md] (Provisioning profile "<profile-name>") #usb-type none
(host) [md] (Provisioning profile "<profile-name>") #cellular_nw_preference 3g_only
```

To enable 3G/4G network switch support, execute the following commands:

```
(host) [md] (config) #ap provisioning-profile <profile-name>
(host) [md] (Provisioning profile "<profile-name>") usb-type <USB modem type>
(host) [md] (Provisioning profile "<profile-name>") #usb-type none
(host) [md] (Provisioning profile "<profile-name>") #cellular_nw_preference auto
```

### RAP 3G/4G Backhaul Link Quality Monitoring

The RAP is enhanced to support link monitoring on 2G, 3G, and 4G modems to provide information about the state of the USB modem and cellular network.

The USB modem has the following four states:



- **Active** - The USB modem is used as the primary path for connecting VPN to the managed device
- **Standby** or **Backup** - The network is available but the USB modem is not used for connecting VPN to the managed device
- **Error** - The USB modem is available but the modem is faulty
- **Not Plugged** - The USB modem is unavailable

To view the USB modem details on the RAP, execute the following command:

```
(host) [md] #show ap debug usb ap-name <ap-name>
```

## Configuring RAP-3WN and RAP-3WNP Access Points

The ArubaRAP-3WN and RAP-3WNP are single-radio, single-band wireless APs that support the IEEE 802.11n standard for high-performance WLAN. These APs use MIMO (Multiple-In, Multiple-Out) technology and other high-throughput mode techniques to deliver high-performance 802.11n 2.4 GHz functionality while simultaneously supporting existing 802.11 b/g wireless services.

The Power Sourcing Equipment (PSE) functionality is available only for RAP-3WNP APs, as the PoE itself provides the PSE functionality for RAP-3WN APs. You can use the WebUI or CLI to enable or disable the PSE functionality on the RAP-3WNP APs.

### In the WebUI

1. In the **Mobility Master** node hierarchy, navigate to the **Configuration > System > Profiles** tab.
2. Click **AP** and select **AP Ethernet Link** under **All Profiles**.
3. Click a profile under **AP Ethernet Link**.
4. Click **Power over Ethernet** check box.
5. Click **Save**. Support for RAP-3WN and RAP-3WNP access points (APs) is enabled.
6. Click **Pending Changes**.
7. In the **Pending Changes** window, select the check box and click **Deploy changes**.

### In the CLI

To enable power over ethernet, execute the following command.

```
(host) [mynode] (config) #ap enet-link-profile <name>
    poe
```

To disable power over ethernet, execute the following command.

```
(host) [mynode] (config) #ap enet-link-profile <name>
    no poe
```

To view the PoE port status on the an AP, execute the following command:

```
(host) [mynode] #show ap enet-link-profile default
```

## Converting an IAP to RAP or CAP

For Instant AP to RAP or CAP conversion, the virtual controller sends the convert command to all the other Instant APs. The virtual controller along with the other slave Instant APs then set up a VPN tunnel to the remote controller, and download the firmware by FTP. The virtual controller uses IPsec to communicate to the controller over the Internet.




---

A mesh point cannot be converted to a RAP because mesh does not support VPN connection.

---

## Converting IAP to RAP

To convert an IAP to RAP, follow the instructions below:

1. Navigate to the **Maintenance** tab in the top right corner of the Instant UI.
2. Click the **Convert** tab.
3. Select **Remote APs managed by a Mobility Controller** from the drop-down list.
4. Enter the hostname (fully qualified domain name) or the IP address of the managed device in the **Hostname or IP Address of Mobility Controller** text box. This information is provided by your network administrator.



---

Ensure the controller IP Address is reachable by the IAPs.

---

5. Click **Convert Now** to complete the conversion.
6. The IAP reboots and begins operating in RAP mode.
7. After conversion, the IAP is managed by the Aruba controller which has been specified in the Instant UI.



---

In order for the RAP conversion to work, ensure that you configure the Instant AP in the RAP white-list and enable the FTP service on the controller.

---



---

If the VPN setup fails and an error message pops up, please click OK, copy the error logs and share them with your Aruba support engineer.

---

## Converting an IAP to CAP

To convert an IAP to a Campus AP, do the following:

1. Navigate to the **Maintenance** tab in the top right corner of the Instant UI.
2. Click the **Convert** tab.
3. Select **Campus APs managed by a Mobility Controller** from the drop-down list.
4. Enter the hostname (fully qualified domain name) or the IP address of the controller in the **Hostname or IP Address of Mobility Controller** text box. This is provided by your network administrator.



---

Ensure that the controller IP Address is reachable by the APs.

---

5. Click **Convert Now** to complete the conversion.

## Enabling Bandwidth Contract Support for RAPs

Bandwidth Contract support on RAPs is achieved by extending the Bandwidth Contract support on split-tunnel and bridge modes. You can apply Bandwidth Contract for a RAP on a per-user or per-role basis. Bandwidth Contract is applied on a per-role basis by default. This implies that all the users belonging to the same role will share the bandwidth pool. When Bandwidth Contract configured on the managed device is attached to a user-role, it automatically gets pushed to the RAPs terminating on it.

The following show commands have been enhanced to retrieve the Bandwidth Contract information from the RAP:

```
(host) [md] #show datapath user ap-name <ap-name>  
(host) [md] #show datapath bwm ap-name <ap-name>
```

## Configuring Bandwidth Contracts for RAP

The following examples illustrate how to configure, apply, and verify the Bandwidth Contracts on the RAPs.

### Defining Bandwidth Contracts

Use the following command to define a 256 Kbps contract:

```
(host) [md] (config) #aaa bandwidth-contract 256k kbits 256
```

Use the following command to define a 512 Kbps contract

```
(host) [md] (config) #aaa bandwidth-contract 512k kbits 512
```

### Applying Contracts

You can apply the contract on a per-role or per-user basis.

#### Applying Contracts Per-Role

Use the following commands to apply the contracts on a per-role basis for upstream and downstream:

For upstream contract of 512 Kbps:

```
(host) [md] (config) #user-role authenticated bw-contract 512k upstream
```

For downstream contract of 256 Kbps:

```
(host) [md] (config) #user-role authenticated bw-contract 256k downstream
```

#### Applying Contracts Per-User

Use the following commands to apply the contracts on a per-user basis for upstream and downstream:

For upstream contract of 512 Kbps:

```
(host) [md] (config) #user-role authenticated bw-contract 512k per-user upstream
```

For downstream contract of 256 Kbps:

```
(host) [md] (config) #user-role authenticated bw-contract 256k per-user downstream
```

### Verifying Contracts on AP

The following example displays the bandwidth contracts on an AP for per-role configuration:

```
(host) [md] #show datapath bwm ap-name rap5-2
Datapath Bandwidth Management Table Entries
-----
Contract Types :
0 - CP Dos 1 - Configured contracts 2 - Internal contracts
-----
Flags: Q - No drop, P - No shape(Only Policed),
T - Auto tuned
-----
Cont          Avail  Queued/Pkts
Type Id      Bits/sec Policed  Bytes   Bytes   Flags
-----
1    1        512000    0   16000    0/0    P
1    2        256000    0    8000    0/0    P
```

The following example displays the bandwidth contracts on AP for per-user configuration (contract IDs 3 and 4 are per-user contracts):

```
(host) [md] #show datapath bwm ap-name rap5-2
Datapath Bandwidth Management Table Entries
-----
Contract Types :
0 - CP Dos 1 - Configured contracts 2 - Internal contracts
-----
```

Flags: Q - No drop, P - No shape (Only Policed),  
T - Auto tuned

Cont Type	Id	Bits/sec	Avail Policed	Queued/Pkts Bytes	Bytes	Flags
1	1	512000	300	16000	0/0	P
1	2	256000	277	8000	0/0	P
1	3	512000	0	16000	0/0	P
1	4	256000	0	8000	0/0	P

## Verifying Contracts Applied to Users

You can verify if the contracts are applied to the user after the user connects to the AP using CLI.

The following is a sample output for a per-role configuration:

```
(host) [md] #show datapath user ap-name rap5-2
Datapath User Table Entries
-----
Flags: P - Permanent, W - WEP, T- TKIP, A - AESCCM, G - AESGCM, V - ProxyArp to/for MN
(Visitor),
N - VPN, L - local, Y - Any IP user, R - Routed user, M - Media Capable,
S - Src NAT with VLAN IP, E - L2 Enforced, F - IPIP Force Delete, O - VOIP user
FM(Forward Mode): S - Split, B - Bridge, N - N/A
IP          MAC          ACLs      Contract  Location  Age  Sessions  Flags  Vlan  FM
-----
--
10.15.72.50  00:0B:86:61:12:AC  2703/0    0/0       0/0       0    16        1/65535  P    0
N
10.15.72.253 00:18:8B:A9:A8:DF  52/0     1/2       0/0       0    1         0/65535  P    1
S
192.168.11.1 00:0B:86:66:03:3F  2700/0    0/0       0/0       0   20024     0/65535  P   177
N
10.15.196.249 00:0B:86:66:03:3F  2700/0    0/0       0/0       0    3         1/65535  P    1
N
```

The following is a sample output for a per-user configuration:

```
(host) [mynode] #show datapath user ap-name rap5-2
Datapath User Table Entries
-----
Flags: P - Permanent, W - WEP, T- TKIP, A - AESCCM, G - AESGCM, V - ProxyArp to/for MN
(Visitor),
N - VPN, L - local, Y - Any IP user, R - Routed user, M - Media Capable,
S - Src NAT with VLAN IP, E - L2 Enforced, F - IPIP Force Delete, O - VOIP user
FM(Forward Mode): S - Split, B - Bridge, N - N/A
IP          MAC          ACLs      Contract  Location  Age  Sessions  Flags  Vlan  FM
-----
--
10.15.72.50  00:0B:86:61:12:AC  2703/0    0/0       0/0       0    11        0/65535  P    0
N
10.15.72.253 00:18:8B:A9:A8:DF  52/0     3/4       0/0       0    46        0/65535  P    1
S
192.168.11.1 00:0B:86:66:03:3F  2700/0    0/0       0/0       0   20883     0/65535  P   177
N
10.15.196.249 00:0B:86:66:03:3F  2700/0    0/0       0/0       0    15        1/65535  P    1
N
```

## Verifying Bandwidth Contracts During Data Transfer

You can verify the Bandwidth Contracts that are in use during data transfer using CLI.

The following is a sample output for a per-role configuration:

```
(host) [md] #show datapath session ap-name rap5-2 table 10.15.72.99
```

Datapath Session Table Entries

-----  
Flags: F - fast age, S - src NAT, N - dest NAT  
D - deny, R - redirect, Y - no syn  
H - high prio, P - set prio, T - set ToS  
C - client, M - mirror, V - VOIP  
Q - Real-Time Quality analysis  
I - Deep inspect, U - Locally destined  
E - Media Deep Inspect, G - media signal  
RAP Flags: 1 - Class 1, 2 - Class 2, 3 - Class 3

Source IP	Destination IP	Prot	SPort	DPort	Cntr	Prio	ToS	Age	Destination	TAge	Flags
10.15.72.253	10.15.72.99	6	5001	36092	1/1	0	0	0	dev12	6	
10.15.72.253	10.15.72.99	6	3488	5001	1/1	0	0	0	dev5	6	C
10.15.72.99	10.15.72.253	6	5001	3488	1/2	0	0	0	dev5	6	
10.15.72.99	10.15.72.253	6	36092	5001	1/2	0	0	0	dev12	6	C

The following is a sample output for a per-user configuration:

```
(host) [md] #show datapath session ap-name rap5-2 table 10.15.72.99
```

Datapath Session Table Entries

-----  
Flags: F - fast age, S - src NAT, N - dest NAT  
D - deny, R - redirect, Y - no syn  
H - high prio, P - set prio, T - set ToS  
C - client, M - mirror, V - VOIP  
Q - Real-Time Quality analysis  
I - Deep inspect, U - Locally destined  
E - Media Deep Inspect, G - media signal  
RAP Flags: 1 - Class 1, 2 - Class 2, 3 - Class 3

Source IP	Destination IP	Prot	SPort	DPort	Cntr	Prio	ToS	Age	Destination	TAge	Flags
10.15.72.253	10.15.72.99	6	3489	5001	1/3	0	0	0	dev5	37	FC
10.15.72.99	10.15.72.253	6	5001	3489	1/4	0	0	0	dev5	37	F
10.15.72.99	10.15.72.253	6	36096	5001	1/4	0	0	0	dev12	37	C
10.15.72.253	10.15.72.99	6	5001	36096	1/3	0	0	0	dev12	37	

Virtual Intranet Access (VIA) is part of the Aruba remote networks solution intended for teleworkers and mobile users. VIA detects the network environment (trusted and untrusted) of the user and connects the users to the enterprise network. Trusted networks refers to a protected office network that allows users to directly access the corporate intranet. Untrusted networks are public Wi-Fi hotspots such as airports, cafes, or home network.

The VIA solution includes the VIA client, Mobility Master with managed device configuration.

- VIA client— Remote workers and mobile users can install VIA on their computers and smart devices (iOS and Android) to connect to their enterprise network from remote locations.
- Mobility Master and managed device configuration— To setup VIA for remote users, configure the VPN for VIA in the Mobility Master and configure the authentication profile, and connection profile in the managed network.

In the WebUI, VIA options are in the following navigations:

- In the **Mobility Master** node hierarchy, navigate to **Configuration > Services > VPN > VIA**.
- In the **Managed Network** node hierarchy, navigate to **Configuration > Authentication > L3 Authentication:**
  - **VIA Authentication**
  - **VIA Connection**
  - **VIA Web Authentication**

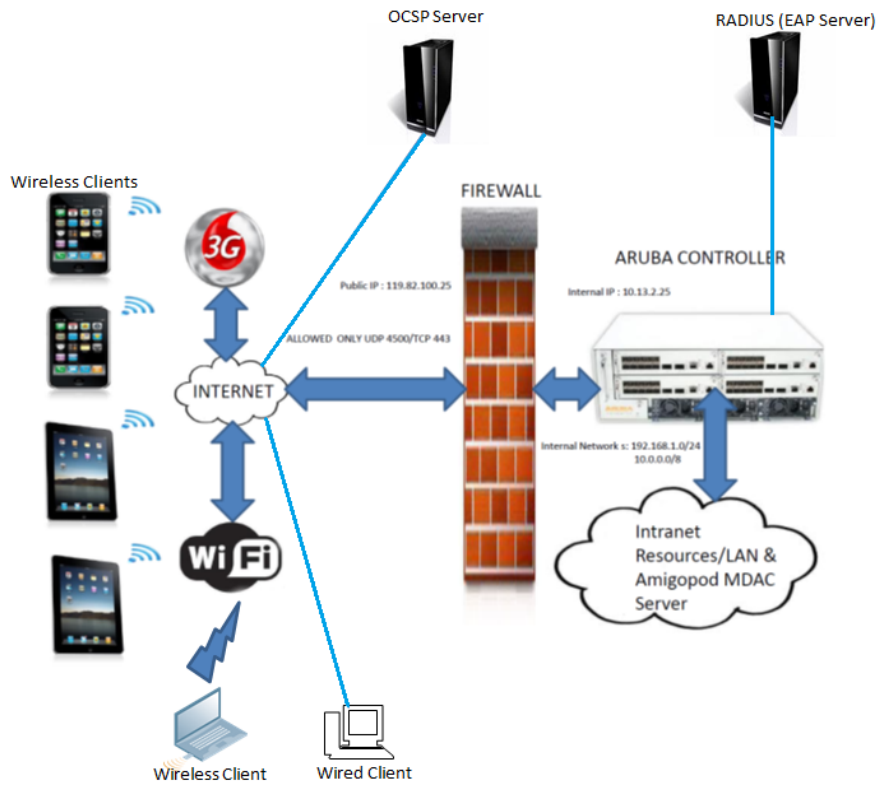


---

VIA requires the PEFV license.

---

**Figure 52** VIA Topology



For more details on configuring, installing, and using VIA, refer to the latest version of the *Aruba VIA 3.0.0 for Mobility Master User Guide*.

Wireless networks operate in environments with electrical and radio frequency devices that can interfere with network communications. Microwave ovens, cordless phones, and even adjacent Wi-Fi networks are all potential sources of continuous or intermittent interference. The spectrum analysis software modules on APs that support this feature examine the radio frequency (RF) environment in which the Wi-Fi network is operating, identify interference and classify its sources. An analysis of the results quickly isolate issues with packet transmission, channel quality, and traffic congestion caused by contention with other devices operating in the same band or channel.

AP radios that gather spectrum data but do not service clients are called spectrum monitors, or SMs. Each SM scans and analyzes the spectrum band used by the SM's radio (2.4Ghz or 5Ghz). An AP radio in *hybrid AP* mode continues to serve clients as an access point while analyzing spectrum analysis data for the channel the radio uses to serve clients. You can record data for both types of spectrum analysis devices, save that data, and then play it back for later analysis.

Topics in this chapter include:

- [Understanding Spectrum Analysis on page 688](#)
- [Creating Spectrum Monitors and Hybrid APs on page 693](#)
- [Connecting Spectrum Devices to Spectrum Analysis Client on page 695](#)
- [Configuring Spectrum Analysis Dashboards on page 697](#)
- [Customizing Spectrum Analysis Graphs on page 699](#)
- [Working with Non-Wi-Fi Interferers on page 713](#)
- [Understanding Spectrum Analysis Session Log on page 714](#)
- [Viewing Spectrum Analysis Data on page 714](#)
- [Recording Spectrum Analysis Data on page 715](#)
- [Troubleshooting Spectrum Analysis on page 717](#)

## Understanding Spectrum Analysis

The table below lists the AP models that support the spectrum analysis feature. Single-radio mesh APs do not support the spectrum analysis feature; if an AP radio has a virtual AP carrying mesh backhaul traffic, no other virtual AP on that radio can be configured as a spectrum monitor. However, dual-radio mesh APs can have the client access radio configured as a Spectrum monitor or hybrid AP while the other radio supports mesh backhaul traffic.



**Table 134:** Device Support for Spectrum Analysis

Device	Configurable as a Spectrum Monitor?	Configurable as a Hybrid AP?
320 Series	Yes	Yes
210 Series	Yes	Yes
200 Series	Yes	Yes
220 Series	Yes	Yes
270 Series	Yes	Yes
AP-114	Yes	Yes
AP-115	Yes	Yes
AP-104	Yes	Yes
AP-105	Yes	Yes
130 Series	Yes	Yes
AP-175	Yes	No
RAP-3WN Series	Yes	No

The radios on groups of APs can be converted to dedicated spectrum monitors or hybrid APs via the AP group's dot11a and dot11g radio profiles. Individual APs can also be converted to spectrum monitors through the AP's spectrum override profile.



---

The spectrum analysis feature requires the RF Protect license. To convert an AP to a spectrum monitor or hybrid AP, you must have an AP license *and* an RFProtect license for each AP on that managed device.

---

The **Spectrum Analysis** tab of the **Diagnostics > Tools** in the WebUI includes the **Spectrum Dashboards**, **Spectrum Monitors**, and **Session Log** windows.

- **Spectrum Monitors:** this window displays a list of active spectrum monitors and hybrid APs streaming data to your client, the radio band the device is monitoring, and the date and time the SM or hybrid AP was connected to your client. This window allows you to select the spectrum monitors or hybrid APs for which you want to view information, and release the connection between your client and any device you no longer want to view.
- **Session Log:** this tab displays activity for spectrum monitors and hybrid APs during the current browser session, including timestamps showing when the devices were connected to and disconnected from the client, and any changes to a hybrid APs monitored channel.
- **Spectrum Dashboards:** this window shows different user-customizable data charts for 2.4 GHz and 5 GHz spectrum monitor or hybrid AP radios. [Table 135](#) below gives a basic description of each of the spectrum analysis graphs that can appear on the spectrum dashboard.



For more detailed information on these graphs, refer to [Customizing Spectrum Analysis Graphs on page 699](#).

**Table 135: Spectrum Analysis Graphs**

Graph Title	Description	Update Interval
Active Devices	A pie chart showing the percentages and total numbers of each device type for all active devices. This graph has no set update interval; the graph automatically updates when values change. For details, see <a href="#">Active Devices on page 699</a> .	N/A
Active Devices Trend	A line chart showing the numbers of up to five different types of Wi-Fi and non-Wi-Fi devices seen on selected channels during a specified time interval. This chart can show devices on multiple channels for a spectrum monitor, or the single monitored channel for a hybrid AP. For details, see <a href="#">Active Devices Trend on page 700</a> .	5 seconds
Channel Metrics	This stacked bar chart shows the current relative quality, availability or utilization of selected channels in the 2.4 GHz or 5 GHz radio bands. This chart can show multiple channels for a spectrum monitor, or the single monitored channel for a hybrid AP. For details, see <a href="#">Channel Metrics on page 701</a> .	5 seconds
Channel Metrics Trend	A line chart showing the relative quality or availability of selected channels in the 2.4 GHz or 5 GHz radio bands over a specified time interval. Spectrum monitors can show channel data for multiple channels, while a hybrid AP shows information only for its one monitored channel. For details, see <a href="#">Channel Metrics Trend on page 702</a> .	5 seconds
Channel Utilization Trend	A line chart that shows the channel utilization for one or more radio channels, as measured over a defined time interval. Spectrum monitors can show data for multiple channels, while a hybrid AP shows utilization levels for its one monitored channel only. For details, see <a href="#">Channel Utilization Trend on page 703</a> .	5 seconds
Device Duty Cycle	A stacked bar chart showing the percent of each channel in the spectrum monitor radio's frequency band used by a Wi-Fi AP or any other device type detected by the spectrum monitor. The Device Duty Cycle chart for a hybrid AP only shows data for the one channel monitored by the hybrid AP. For details, see <a href="#">Device Duty Cycle on page 704</a> .	5 seconds
Devices vs Channel	A stacked bar chart showing the total numbers of each device type detected on each channel in the spectrum monitor radio's frequency band. The Devices vs Channel chart for a hybrid AP only shows data for the one channel monitored by the hybrid AP. For details, see <a href="#">Devices vs Channel on page 705</a> .	5 seconds

Graph Title	Description	Update Interval
FFT Duty Cycle	Fast Fourier Transform, or <b>FFT</b> , is an algorithm for computing the frequency spectrum of a time-varying input signal. This line chart shows the FFT duty cycle, which represents the percent of time a signal is broadcast on the specified channel or frequency. Spectrum monitors can show data for multiple channels, while a hybrid AP shows information only for its one monitored channel.  For details, see <a href="#">FFT Duty Cycle on page 706</a> .	1 second
Interference Power	This chart shows information about Wi-Fi interference, including the Wi-Fi noise floor, and the amount of adjacent channel interference from cordless phones, bluetooth devices and microwaves. Spectrum monitors can show interference power data for multiple channels, while a hybrid AP shows information only for its one monitored channel. For details, see <a href="#">Interference Power on page 707</a> .	5 seconds
Quality Spectrogram	This plot shows quality statistics for selected range of channels or frequencies as determined by the current noise floor, non-Wi-Fi (interferer) utilization and duty-cycles and certain types of retries. This chart can also be configured to show channel availability, the percentage of each channel that is unused and available for additional traffic. Spectrum monitors can show data for multiple channels, while a hybrid AP shows information only for its one monitored channel. For details, see <a href="#">Quality Spectrogram on page 708</a> .	5 seconds
Real-Time FFT	Fast Fourier Transform, or <b>FFT</b> , is an algorithm for computing the frequency spectrum of a time-varying input signal. This line chart shows the power level of a signal on the channels or frequencies monitored by a spectrum monitor radio. Spectrum monitors can show data for multiple channels, while a hybrid AP shows information only for its one monitored channel. For details, see <a href="#">Real-Time FFT on page 709</a> .	1 second
Swept Spectrogram	This plot displays FFT power levels For details, see or the FFT duty cycle for a selected channel or frequency, as measured during each time tick. Spectrum monitors can show data for multiple channels, while a hybrid AP shows information only for its one monitored channel. For details, see <a href="#">Swept Spectrogram on page 711</a> .	1 second

## Spectrum Analysis Clients

The maximum number of spectrum monitor radios and hybrid AP radios on a stand-alone controller is limited only by the number of APs on that stand-alone controller. If desired, you can configure every radio on an AP that supports the Spectrum Analysis feature as a spectrum device. A dual-radio AP can operate as two spectrum devices, because each radio can be individually configured as a spectrum monitor (SM) or hybrid AP.

A spectrum analysis client can simultaneously access data from up to four individual spectrum device radios. Each spectrum device radio, however, can only be connected to a single client WebUI.

When you select a specific spectrum monitor or hybrid AP radio to stream data to your client, the stand-alone controller first verifies the device is not subscribed to some other client. Once the SM or hybrid AP radio has been verified as available, the SM or hybrid AP establishes a connection to the client and begins sending

spectrum analysis data either every second or every five seconds, depending on the type of data being requested. Each client may select up to twelve different spectrum analysis charts and graphs to appear in the spectrum dashboard.

A stand-alone controller can support up to 22 active WebUI connections. If spectrum analysis clients are simultaneously viewing data for than 22 WebUI connections, any additional WebUI requests are refused until some clients close their WebUI browser sessions.

When you finish reviewing data from an SM or hybrid AP, you should disconnect the device from your spectrum client. Do not forget this important step—no other user can access data from that spectrum monitor or hybrid AP until you release your subscription. Note, however, that when you disconnect a spectrum monitor from your client, *the AP continues to operate as a spectrum monitor* until you return it to AP mode by removing the local spectrum override, or by changing the mode parameter in the AP's 802.11a or 802.11g radio profile from spectrum-mode back to AP-mode.



---

A spectrum monitor or hybrid AP automatically disconnects from a client when you close the browser window you used to connect the spectrum monitor to your client. However, if you use Internet Explorer and have multiple instances of an Internet Explorer browser open, the data-streaming connection to the spectrum monitor or hybrid AP is not released until 60 seconds after you close the spectrum client browser window. During this 60-second period, the spectrum monitor is still connected to the client.

---

When a spectrum monitor or hybrid AP is not subscribed to any client, it still performs all classification tasks and collect all necessary channel lists and device information. You can view classification, device, and channel information for any active spectrum monitor or hybrid AP via the stand-alone controller's command-line interface, regardless of whether or not that device is sending real-time spectrum data to another client WebUI.

Individual spectrum analysis graphs and charts are explained in detail in [Customizing Spectrum Analysis Graphs on page 699](#).

## Hybrid AP Channel Changes

By default, a hybrid AP only monitors the channel specified in its 802.11a or 802.11g radio profile for spectrum interference. If you want to change the channel monitored by a hybrid AP, you must edit the channel setting in those profiles. However, there are other ArubaOS features that may automatically change the channels on hybrid APs. APs using Dynamic Frequency Selection (DFS) perform off-channel scanning to detect the presence of satellite and radar transmissions, and switch to a different channel if it detects that satellite or radar transmissions are present. APs using the Adaptive Radio Response (ARM) feature constantly monitor the network and automatically select the best channel and transmission power settings for that AP. If you manually change a channel monitored by a hybrid AP, best practices are to temporarily disable ARM, as ARM may automatically return the channel to its previous setting.

If a hybrid AP is using ARM or DFS, that hybrid AP may automatically move to a different channel in response to changes in the network environment. If a hybrid AP changes channels while it is connected to a spectrum analysis client, the hybrid AP updates the graphs in the spectrum dashboard to start displaying spectrum data for the new channel, and sends a log message to the session log. For details on changing the channel monitored by a hybrid AP, see [2.4 Ghz and 5 Ghz Radio RF Management on page 530](#).

## Hybrid APs Using Mode-Aware ARM

If a radio is configured as a hybrid AP and that AP is enabled with mode-aware ARM, the hybrid AP can change to an Air Monitor (or *AM*) if too many APs are detected in the area. If ARM changes a hybrid AP to an Air Monitor, that AM does not provide spectrum data after the mode change. The AM unsubscribes from any connected spectrum analysis client, and sends a log message warning about the change. If mode-aware ARM changes the AM back to an AP, the hybrid AP does not automatically resubscribe back to the spectrum analysis

client. The hybrid AP must manually resubscribed before it can appear in the client's **spectrum monitors** page.

## Creating Spectrum Monitors and Hybrid APs

Each stand-alone controller can support up to 22 active WebUI connections to spectrum monitor or hybrid AP radios. If you plan on using spectrum monitors or hybrid APs as a permanent overlay to constantly monitor your network, you should create a separate AP group for these devices. If you plan on temporarily converting campus APs to spectrum monitors, best practices are to use the spectrum local override profile to convert an AP to a spectrum monitor.

This section describes the following tasks for converting regular APs into hybrid APs or spectrum monitors.

- [Converting APs to Hybrid APs on page 693](#)
- [Converting AP to Spectrum Monitor on page 694](#)
- [Converting Group of APs to Spectrum Monitors on page 695](#)

### Converting APs to Hybrid APs

You can convert a group of regular APs into a group of hybrid APs by selecting the **spectrum monitor** option in the AP group's 802.11 a and 802.11 g radio profiles. Once you have enabled the spectrum monitoring option, all APs in the group that support the spectrum monitoring feature start to function as hybrid APs. If any AP in the group does *not* support the spectrum monitoring feature, that AP continues to function as a standard AP, rather than a hybrid AP.



---

The spectrum monitoring option in the 802.11 a and 802.11 g radio profiles only affects APs in ap-mode. Devices in am-mode (Air Monitors) or sm-mode (Spectrum Monitors) are not affected by enabling this option.

---

If you want to convert a individual AP (and not an entire AP group) to a hybrid AP, you must create a new 802.11 a or 802.11 g radio profile, enable the **spectrum monitor** option, then reassign that AP to the new profile. For additional information see [Creating and Editing Mesh High-Throughput SSID Profiles on page 576](#) for details on how to create a new 802.11 a/g radio profile, then assign an individual AP to that profile.



---

If the spectrum local-override profile on the stand-alone controller that terminates the AP contains an entry for a hybrid AP radio, that entry overrides the mode selection in the 802.11 a or 802.11 g radio profile, and the AP operates as a spectrum monitor, not as a hybrid AP. You must remove any spectrum local override for an AP to allow the device to operate as a hybrid AP. For further details on editing a spectrum local override, see [Converting AP to Spectrum Monitor on page 694](#).

---

### In the WebUI

Follow the procedure below to convert a group of APs to hybrid mode via the WebUI.

1. In the **Mobility Master** node hierarchy, navigate to **Configuration > AP Groups**.
2. Select an **AP Group**.
3. Click **Radio** tab for the selected AP group.
4. Under **Basic > Radio mode**, select **spectrum-mode** under either 2.4 GHz or 5 GHz.
5. Click **Submit**.
6. Click **Pending Changes**.
7. In the **Pending Changes** window, select the required check box and click **Deploy changes**.

## In the CLI

To convert a group of APs via the command-line interface, access the CLI in config mode and issue the following commands, where profile is the name of the 802.11a or 802.11g radio profile used by the group of APs you want to convert to hybrid APs:

```
rf dot11a-radio-profile <profile> spectrum-monitoring
rf dot11g-radio-profile <profile> spectrum-monitoring
```

## Converting AP to Spectrum Monitor

There are two ways to change a radio on an individual AP or AM into a spectrum monitor. You can assign that AP to a different 802.11a and 802.11g radio profile that is already set to spectrum mode, or you can temporarily change the AP into a spectrum monitor using a local spectrum override profile. When you use a local spectrum override profile to override an AP's mode setting, that AP begins to operate as a spectrum monitor, but remains associated with its previous 802.11a and 802.11g radio profiles. If you change any parameter (other than the overridden **mode** parameter) in the spectrum monitor's 802.11a or 802.11g radio profiles, the spectrum monitor immediately updates with the change. When you remove the local spectrum override, the spectrum monitor reverts back to its previous mode, and remains assigned to the same 802.11a and 802.11g radio profiles as before.

The spectrum local override profile overrides the **mode** parameter in the 802.11a or 802.11g radio profile, changing it from ap-mode or am-mode to spectrum-mode, while allowing the spectrum monitor to continue to inherit all other settings from its 802.11a/802.11g radio profiles. When the spectrum local override is removed, the AP automatically reverts to its previous mode as defined in its 802.11a or 802.11g radio profile settings. If you use the local override profile to change an AP radio to a spectrum monitor, you must do so by accessing the WebUI or CLI of the stand-alone controller that terminates the AP.

## In the WebUI

To convert an individual AP using the local spectrum override profile in the WebUI:

1. In the **Mobility Master** node hierarchy, navigate to **Configuration > System**.
2. Select **Profiles** tab.
3. Select **Spectrum Local Override**.
4. In the **Spectrum Local Override Profile**, click **+**.
5. In the **ap\_name**, enter the name of an AP whose radio you want to configure as a spectrum monitor. The AP names are case-sensitive. Any extra spaces before or after the AP name prevents the AP from being correctly added to the override list.
6. If your AP has multiple radios or a single dual-band radio, click the **spectrum\_band** drop-down list and select the spectrum band you want that radio to monitor: **2.4GHz** or **5GHz**.
7. Click **OK** to add that radio to the **Override Entry** list.
8. Repeat steps 4 through 7 to convert other AP radios to spectrum monitors, if required.
9. To remove spectrum monitor from the override entry list, select that radio name in the override entry list, then click **Delete**.
10. Click **Submit**.
11. Click **Pending Changes**.
12. In the **Pending Changes** window, select the required check box and click **Deploy changes**.

## In the CLI

To convert an individual AP spectrum monitor using the spectrum local override profile in the command-line interface, access the CLI in config mode and issue the following command:

```
ap spectrum local-override override ap-name <ap-name> spectrum-band 2ghz|5ghz
```

## Converting Group of APs to Spectrum Monitors

When you convert a group of APs to spectrum monitors using their 802.11a/802.11g radio profiles, all AP radios associated with that profile stop serving clients and act as spectrum monitors only. Therefore, before you convert an entire group of APs to spectrum monitors, be sure that none of the APs are currently serving clients, as that may temporarily interrupt service to those clients.

---

If you use an 802.11a or 802.11g radio profile to create a group of spectrum monitors, all APs in any AP group referencing that radio profile are set to spectrum mode. Therefore, best practices are to create a new 802.11a or 802.11g radio profile just for spectrum monitors, using the following CLI commands:

```
ap-name <ap name> dot11a-radio-profile <profile-name>ap-name <ap name> dot11g-radio-profile  
<profile-name>
```



NOTE

If you want to set an existing 802.11a or 802.11g radio profile to spectrum mode, verify that no other AP group references that radio profile, using the following CLI commands:

```
show references rf dot11a-radio-profile <profile-name>show references rf dot11g-radio-  
profile <profile-name>
```

---

### In the WebUI

Follow the procedure below to convert a group of APs to Spectrum mode via the WebUI.

1. In the **Mobility Master** node hierarchy, navigate to **Configuration > AP Groups**.
2. Select an **AP Group**.
3. Click **Radio** tab for the selected AP group.
4. Under **Basic > Radio mode**, select **spectrum-mode** under either 2.4 GHz or 5 GHz.
5. Click **Submit**.
6. Click **Pending Changes**.
7. In the **Pending Changes** window, select the required check box and click **Deploy changes**.

### In the CLI

To convert a group of APs via the command-line interface, access the CLI in config mode and issue the following commands, where **<profile>** is the 80211a or 80211g radio profile used by the AP group.

```
rf dot11a-radio-profile <profile> mode spectrum-mode  
rf dot11g-radio-profile <profile> mode spectrum-mode
```

## Connecting Spectrum Devices to Spectrum Analysis Client

A spectrum analysis client is any laptop or desktop computer that can access a stand-alone controller WebUI and receive streaming data from individual spectrum monitors or hybrid APs. Once you have configured one or more APs to operate as a spectrum monitor or hybrid AP, use the **Spectrum Monitors** window to identify the spectrum devices you want to actively connect to the spectrum analysis client.



NOTE

---

The Spectrum Analysis option is not available if the license is not enabled or present.



---

To connect one or more spectrum devices to your client:

1. In the **Mobility Master** node hierarchy, navigate to **Diagnostics > Tools > Spectrum Analysis**.
2. Click **Launch** to launch the Spectrum Analysis tool.
3. Click the **Spectrum Monitors** tab in the new window.
4. Click the **Spectrum Monitors** tab.

- Click **Add**. A table appears, displaying a list of spectrum analysis devices, sorted by name. Single-radio spectrum devices have a single entry in this table, and dual-radio spectrum devices have two entries: one for each radio. This table displays the following data for each radio.

**Table 136:** *Spectrum Device Selection Information*

Table Column	Description
AP	<p>Name of the AP whose radio you want to convert to a spectrum monitor. AP names are case sensitive.</p> <p>This column includes the following icons:</p> <ul style="list-style-type: none"> <li> Radio is operating as a spectrum monitor.</li> <li> Radio is operating as a hybrid AP with spectrum enabled.</li> </ul>
Band	The frequency band currently used by the radio. This value can be either <b>2.4 GHz</b> or <b>5 GHz</b> .
Model	AP model type.
AP Group	Name of the AP group to which the spectrum monitor is currently associated.
Mode	<p>This column indicates the type of spectrum analysis device:</p> <ul style="list-style-type: none"> <li>● <b>Spectrum Monitor:</b> AP is in spectrum monitor mode.</li> <li>● <b>Access Point:</b> AP is configured as an access point but with spectrum monitoring enabled (Hybrid AP).</li> </ul>
Availability for Connection	<p>Indicates if the AP is available to send spectrum analysis data to the client. Possible options are:</p> <ul style="list-style-type: none"> <li>● <b>Available, 2.4GHz:</b> the radio is available to send spectrum analysis data on the 2.4GHz frequency band.</li> <li>● <b>Available, 5GHz:</b> the radio is available to send spectrum analysis data on the 5GHz frequency band.</li> <li>● <b>Available, Dual Band:</b> the radio is available and is capable of sending spectrum analysis data on either the 2.4 GHz or the 5 GHz frequency bands.</li> <li>● <b>Available, current channel - &lt;channel&gt;:</b> the AP radio is in hybrid mode and can display spectrum analysis data for the single specified channel only.</li> <li>● <b>Not available:</b> an AP may not be available because it is currently sending spectrum analysis data to another client.</li> </ul>

- Click the table entry for a spectrum monitor radio, then click **Connect**.
- Repeat steps 3-4 to connect additional devices, if desired.

## View Connected Spectrum Analysis Devices

Once you have connected one or more spectrum monitors or hybrid APs to your Spectrum Analysis client, the **Diagnostics > Tools > Spectrum Analysis > Spectrum Monitors** window displays a table of currently connected spectrum devices. This table includes the name of each spectrum monitor or hybrid AP and its current radio band (2 GHz or 5 GHz):



To view a list of connected spectrum devices via the command-line interface, issue the **show ap spectrum monitors** command:

## Disconnecting Spectrum Device

A spectrum monitor or hybrid AP can send spectrum analysis data to only one client at a time. When you are done viewing data for a spectrum device, you should release your client's subscription to that spectrum device and allow other clients to view data from that device. A spectrum monitor or hybrid AP automatically disconnects from your client when you close the browser window used to connect the spectrum device your client.

To manually disconnect a spectrum monitor or hybrid APs:

1. In the **Mobility Master** node hierarchy, navigate to **Diagnostics > Tools > Spectrum Analysis**.
2. Click **Launch** to launch the Spectrum Analysis tool.
3. Click the **Spectrum Monitors** tab in the new window.
4. Click the **Spectrum Monitors** tab.
5. Each table entry in the **Currently Connected** table includes a **Disconnect** link to release the client's connection to that spectrum monitor. Identify the table entry for the spectrum monitor you want to release then click **Disconnect**.
6. A popup window asks you to confirm that you want to disconnect the spectrum monitor from the spectrum analysis client. Click **OK**. The spectrum monitor disconnects from the client and the device's entry is removed from the **Currently Connected** table.

When you disconnect a spectrum device from your client, the AP continues to operate as a spectrum monitor or hybrid AP until you return the device to AP mode by removing the local spectrum override, or by changing the mode parameter in the AP's 802.11a or 802.11g radio profile from spectrum-mode to AP-mode.



---

If you are use Internet Explorer with multiple instances of the Internet Explorer browser open, and you close the spectrum browser window without manually disconnecting the spectrum device, the stand-alone controller does not release the data streaming connection to a spectrum monitor until 60 seconds after you close the spectrum client browser window. During this 60-second period, the spectrum monitor is still connected to the client.

---

## Configuring Spectrum Analysis Dashboards

Once you have connected spectrum monitors to your spectrum analysis client, you can begin to monitor spectrum data in the spectrum analysis dashboards. There are three predefined sets of dashboard views, **View 1**, **View 2** and **View 3**. View 1 displays the Real-Time FFT, FFT Duty-Cycle and Swept Spectrogram graphs by default, and Views 2 and 3 display the Swept Spectrogram and Quality Spectrogram charts, and the Channel Summary and Active Devices tables.



---

Spectrum Analysis dashboards are available only on stand-alone controllers.

---

Each chart in the dashboard can be replaced with other chart types, or reconfigured to show data for a different spectrum monitor. Once you have configured a dashboard view with different settings, you can rename that dashboard view to better reflect its new content.

The following sections explain how to customize your Spectrum Analysis dashboard to best suit the needs of your individual network:

- [Selecting Spectrum Monitor on page 698](#)
- [Changing Graphs within Spectrum View on page 698](#)
- [Renaming Spectrum Analysis Dashboard View on page 698](#)

- [Saving Dashboard View on page 698](#)
- [Resizing an Individual Graph on page 699](#)

## Selecting Spectrum Monitor

When you first log into the Spectrum Analysis dashboard, it displays blank charts. You must identify the spectrum monitor whose information you want to view before the graphs display any data.

To identify the spectrum monitor radio whose data you want to appear in the Spectrum Analysis dashboard:

1. In the **Mobility Master** node hierarchy, navigate to **Diagnostics > Tools > Spectrum Analysis**.
2. Click **Launch** to launch the Spectrum Analysis tool.
3. Click the **Spectrum Monitors** tab in the new window.
4. Click **Add**.
5. Select a spectrum monitor from the list and click **Connect**.

After you have selected the initial spectrum monitor or hybrid AP for a graph, you can display data for a different spectrum device at any time by clicking the down arrow by the device name in the chart titlebar and selecting a different connected spectrum monitor or hybrid AP.

## Changing Graphs within Spectrum View

To replace an existing graph with any other type of graph or chart:

1. In the **Mobility Master** node hierarchy, navigate to **Diagnostics > Tools > Spectrum Analysis**.
2. Click **Launch** to launch the Spectrum Analysis tool.
3. Click the **Spectrum Dashboards** tab.
4. From **Spectrum Dashboards** window, click one of the view names at the top of the window to select the dashboard layout with the graph you want to change.
5. Click the down arrow at the far right end of the graph title bar to display a drop-down list of chart options.
6. Click **Replace With** to display a list of available graphs.
7. Click the name of the new graph you want to display.

## Renaming Spectrum Analysis Dashboard View

You can rename any of the three spectrum analysis dashboard views at any time. However, renaming a view does not save its settings. (For details on saving a spectrum dashboard view, refer to [Saving Dashboard View on page 698](#).)

To rename a Spectrum Analysis Dashboard view:

1. In the **Mobility Master** node hierarchy, navigate to **Diagnostics > Tools > Spectrum Analysis**.
2. Click **Launch** to launch the Spectrum Analysis tool.
3. Click the **Spectrum Dashboards** tab.
4. Click the down arrow to the right of the dashboard view you want to rename.
5. Select **Rename**.
6. The **Dashboard Name** popup window appears. Enter a new name for the dashboard view, then click **OK**.

## Saving Dashboard View

You can select different graphs to display in a dashboard view, but these changes are not saved unless you save that view. Dashboard views, (like the spectrum analysis profile and spectrum local-override profile) are all local configurations that must be configured on each stand-alone controller.

To save a dashboard view:

1. After selecting the graphs you want to appear in the view, click **Save Spectrum Views** at the top of the window.
2. The **Spectrum View saved successfully** confirmation window appears when the spectrum view has been saved.



---

If you change graphs in a spectrum view but do not save your settings, you are prompted to save or cancel your changes when you close the spectrum dashboard browser window

---

## Resizing an Individual Graph

The left side of the title bar for each graph includes a resizing button on that allows you to expand a graph for easier viewing. Click this button to expand the selected graph to the size of the full window and display the **Options** pane, which allows you to change the current display options for that graph. (Configuration options are described in [Spectrum Analysis Graph Configuration Options on page 699](#)). To close the options pane if you have not made any changes to the graph, click **Close** at the bottom of the **Options** pane or click the resize button again to return the graph to its original size. To save any changes to the graph, click **OK** to save your settings and close the **Options** pane.

## Customizing Spectrum Analysis Graphs

Each Spectrum Analysis graph can be customized to display or hide selected data types. To view the available options for a graph type:

1. In the **Mobility Master** node hierarchy, navigate to **Diagnostics > Tools > Spectrum Analysis**.
2. Click **Launch** to launch the Spectrum Analysis tool.
3. Click the **Spectrum Dashboards** tab in the new window.
4. Click the down arrow at the end of the title bar for the graph you want to configure.
5. Select **Options**. The **Options** window appears to the right of the graph.
6. From the **Options** window, configure graph settings described in [Spectrum Analysis Graph Configuration Options on page 699](#).
7. When you are done, click **Close** at the bottom of the **Options** window to hide the options window.
8. Click **Save Spectrum Views** at the top of the window to save your new settings.

## Spectrum Analysis Graph Configuration Options

The following sections describe the customizable parameters and the default settings for each spectrum analysis graph.

### Active Devices

This graph appears as a pie chart showing the percentages and total numbers of each device type for all active devices seen by the spectrum monitor or hybrid AP radio. This chart is useful for determining which types of devices are sending signals on the specified radio band or channel. The Active Devices graphs for spectrum monitors can be configured to show data for several different device types on a single radio channel or range of channels. Active Devices graphs for hybrid APs can show data for the single monitored channel only.

When you hover your mouse over any section of the pie chart, a tooltip displays the percentage and number of active devices classified into that device type.

Click the down arrow in the upper right corner of this chart then click the **Options** menu to access the configuration settings for the Active Devices graph. Once you have configured the desired parameters, click **OK** at the bottom of the **Options** menu to save your settings and return to the spectrum dashboards.

**Table 137: Active Devices Graph Options**

Parameter	Description
Band	Radio band displayed in this graph (2.4 GHz or 5 GHz)
Channel numbering	This parameter is not configurable for graphs created by hybrid APs or spectrum monitor radios that use the 2.4 GHz radio band. A hybrid AP on a 20 MHz channel sees 40 MHz Wi-Fi data as non-Wi-Fi data. For spectrum monitors using the 5 GHz radio band, click the <b>Channel Numbering</b> drop-down list and select either <b>20 MHz</b> or <b>40 MHz</b> channel numbering to identify a channel numbering scheme for the graph. Graphs for AP radios that support 802.11ac include an additional <b>80MHz</b> option for very-high-throughput channels.
Channel Range	For graphs created by spectrum monitors, specify a channel range to determine which channels appears in this graph. Click the first drop-down list to select the lowest channel in the range, then click the second drop-down list to select the highest channel to appear in the graph.  This graph displays all channels within the spectrum monitor's radio band by default.  <b>NOTE:</b> This parameter is not configurable for graphs created by hybrid APs.

### Active Devices Trend

The Active Devices Trend chart is a line chart that shows the numbers of Wi-Fi and non-Wi-Fi devices seen on each radio channel during the displayed time interval. When you hover your mouse over any line in the chart, a tooltip displays the number of active devices for the selected device type.

An Active Devices Trend chart created by a hybrid AP displays data for the single channel monitored by that device. For spectrum monitors, the Active Devices Trend chart can display values for up to five different channels and device types. These graphs show the following data by default:

- For SMs on the 2.4 GHz radio band, Wi-Fi APs on channel 1, 6, and 11.
- For SMs on the 5 GHz band, Wi-Fi APs on channel 36, 40, and 44.

Click the down arrow in the upper right corner of this chart, then click the **Options** menu to access the Active Devices Trend configuration settings. Once you have configured the desired parameters, click **OK** at the bottom of the **Options** menu to save your settings and return to the spectrum dashboards.

**Table 138: Active Devices Trend Options**

Parameter	Description
Band	Radio band displayed in this graph (2.4 GHz or 5 GHz).
Show Trend for Last	Amount of elapsed time for which this chart should display data.
Channel Numbering	This parameter is not configurable for graphs created by hybrid APs or spectrum monitor radios that use the 2.4 GHz radio band. A hybrid AP on a 20 MHz channel sees 40 MHz Wi-Fi data as non-Wi-Fi data. For spectrum monitors using the 5 GHz radio band, click the Channel Numbering drop-down list and select either <b>20 MHz</b> or <b>40 MHz</b> channel numbering to identify a channel numbering scheme for the graph. Graphs for AP radios that support 802.11ac include an additional <b>80MHz</b> option for very-high-throughput channels.

Parameter	Description
Show lines for these channels	<p>The Active Devices Trend chart can display values for up to five different device types on different channels for a spectrum monitor, or a single device type for a hybrid AP.</p> <p>To choose which type of data each line should represent, click the channel number drop-down list and select a channel within the radio band, then click the device type drop-down list and select one of the following device types.</p> <ul style="list-style-type: none"> <li>• WiFi (AP)</li> <li>• Microwave <i>(This option is only available for 2.4 GHz radios)</i></li> <li>• Bluetooth <i>(This option is only available for 2.4 GHz radios)</i></li> <li>• Fixed Freq (Others)</li> <li>• Fixed Freq (Cordless Phones)</li> <li>• Fixed Freq (Video)</li> <li>• Fixed Freq (Audio)</li> <li>• Freq Hopper (Others)</li> <li>• Freq Hopper (Cordless Network)</li> <li>• Freq Hopper (Cordless Base)</li> <li>• Freq Hopper Xbox <i>(This option is only available for 2.4 GHz radios)</i></li> <li>• Microwave (Inverter) <i>(This option is only available for 2.4 GHz radios)</i></li> <li>• Generic Interferer</li> </ul> <p>Select the check box beside each channel and device entry to show that information on the chart, or deselect the check box to hide that information. For more information on non-Wi-Fi device types detected by a spectrum monitor, see <a href="#">Working with Non-Wi-Fi Interferers on page 713</a>.</p>

## Channel Metrics

This stacked bar chart can show one of three different types of channel metrics; **channel utilization**, **channel availability**, or **channel quality**.

This chart displays channel utilization data by default, showing both the percentage of each monitored channel that is currently being used by Wi-Fi devices, and the percentage of each channel being used by non-Wi-Fi devices and 802.11 adjacent channel interference (ACI).



ACI refers to the interference on a channel created by a transmitter operating in an adjacent channel. A transmitter on a nonadjacent or partially overlapping channel may also cause interference, depending on the transmit power of the interfering transmitter and the distance between the devices. In general, ACI may be caused by a Wi-Fi transmitter or a non-Wi-Fi interferer. However, whenever the term ACI appears in Spectrum Analysis graphs, it refers to the ACI caused by Wi-Fi transmitters. The channel utilization option in the Channel Metrics Chart shows the percentage of the channel utilization due to both ACI and non-Wi-Fi interfering devices. Unlike the ACI shown in the **Interference Power** chart, the ACI shown in this graph indicates the percentage of channel time that is occupied by ACI or unavailable for Wi-Fi communication due to ACI.

The Channel Metrics graph can also show channel availability, the percentage of each channel that is available for use, or display the current relative quality of selected channels in the 2.4 GHz or 5 GHz radio bands. Spectrum monitors can display data for all channels in their selected band. Hybrid APs display data for their one monitored channel only.

In the spectrum analysis feature, channel quality is a relative measure that indicates the ability of the channel to support reliable Wi-Fi communication. Channel quality, which is represented as a percentage in this chart, is a weighted metric derived from key parameters that can affect the communication quality of a wireless channel, including noise, non-Wi-Fi (interferer) utilization and duty-cycles, and certain types of retries. Note that channel quality is not directly related to Wi-Fi channel utilization, as a higher quality channel may or may not be highly used.

When you hover your mouse over any bar in the chart, a tooltip displays the metric value for that individual channel. The example below shows that 61% of channel 3 is being consumed by non-Wi-Fi devices and 802.11 adjacent channel interference.

Click the down arrow in the upper right corner of this chart then click the **Options** menu to access these configuration settings. Once you have configured the desired parameters, click **OK** at the bottom of the **Options** menu to save your settings and return to the spectrum dashboards.

**Table 139:** Channel Metrics Options

Parameter	Description
Band	Radio band displayed in this graph.  For spectrum monitor radios using the 5 GHz radio band, click the <b>Band</b> drop-down list and select <b>5 GHz upper</b> , <b>5GHz middle</b> or <b>5Ghz lower</b> to display data for that portion of the 5 GHz radio band. This parameter is not configurable for graphs created by hybrid APs or spectrum monitor radios that use the 2.4 GHz radio band.
Channel Numbering	This parameter is not configurable for graphs created by hybrid APs or spectrum monitor radios that use the 2.4 GHz radio band. A hybrid AP on a 20 MHz channel sees 40 MHz Wi-Fi data as non-Wi-Fi data. For spectrum monitors using the 5 GHz radio band, click the <b>Channel Numbering</b> drop-down list and select either <b>20 MHz</b> or <b>40 MHz</b> channel numbering to identify a channel numbering scheme for the graph. Graphs for AP radios that support 802.11ac include an additional <b>80MHz</b> option for very-high-throughput channels.
Channel Range	For graphs created by spectrum monitors, specify a channel range to determine which channels appear in this graph. Click the first drop-down list to select the lowest channel in the range, then click the second drop-down list to select the highest channel to appear in the graph.  This graph displays all channels within the spectrum monitor's radio band by default.  <b>NOTE:</b> This parameter is not configurable for graphs created by hybrid APs.
Display Mode	Select <b>Channel Quality</b> to show the relative quality of the channel. Channel Quality is a weighted metric derived from key parameters which include noise, non-Wi-Fi (interferer) utilization and duty-cycles, and certain types of retries.  Select <b>Channel Availability</b> to show the percentage of the channel that is unused and available for additional Wi-Fi traffic.  Select <b>Channel Utilization</b> to show both the percentage of the channel that is currently used by Wi-Fi devices, and the percentage of each channel that is being used by non-802.11 devices or 802.11 adjacent channel interference (ACI).

### Channel Metrics Trend

By default, this line chart shows the current relative quality of selected channels in the 2.4 GHz or 5 GHz radio bands over a period of time. The Channel Metrics Trend chart can also be configured to display trends for the current availability of selected channels, or the percentage of availability for those channels. Spectrum monitors

can display data for up to five different channels. Hybrid APs display data for their one monitored channel only.



For more information on how the spectrum analysis feature determines the quality of a channel, see [Channel Metrics on page 701](#).

When you hover your mouse over any line in the chart, a tooltip displays channel quality or availability data for that individual channel at the selected time.

Click the down arrow in the upper right corner of this chart then click the **Options** menu to access these configuration settings. Once you have configured the desired parameters, click **OK** at the bottom of the **Options** menu to save your settings and return to the spectrum dashboard.

**Table 140:** *Channel Metrics Trend Options*

Parameter	Description
Band	Radio band displayed in this graph (2.4 GHz or 5 GHz).
Show Trend for Last	The Channel Quality Trend chart shows channel quality or channel availability for the past 10 minutes by default. To view data for a different time range, click the <b>Show Trend for Last</b> drop-down list and select one of the following options: <ul style="list-style-type: none"> <li>• 10 minutes</li> <li>• 30 minutes</li> <li>• 1 hour</li> </ul>
Channel numbering	This parameter is not configurable for graphs created by hybrid APs or spectrum monitor radios that use the 2.4 GHz radio band. A hybrid AP on a 20 MHz channel sees 40 MHz Wi-Fi data as non-Wi-Fi data. For spectrum monitors using the 5 GHz radio band, click the <b>Channel Numbering</b> drop-down list and select either <b>20 MHz</b> or <b>40 MHz</b> channel numbering to identify a channel numbering scheme for the graph. Graphs for AP radios that support 802.11ac include an additional <b>80MHz</b> option for very-high-throughput channels.
Show Lines for These Channels	The Channel Quality Trend chart for a spectrum monitor can display channel quality, channel availability, or channel utilization values for up to five different channels on the selected radio band. Charts for hybrid APs can display data for the one channel monitored by that hybrid AP radio.  To choose which type of data each line should represent on a chart for a spectrum monitor, click the <b>channel number</b> drop-down list and select a channel within the radio band, then click the second drop-down list and select either <b>Channel Quality</b> , or <b>Channel Availability</b> .  Select the check box beside each channel entry to show that information on the chart, or deselect the check box to hide that information.

### Channel Utilization Trend

The Channel Utilization Trend chart is a line chart that shows the percentage of total utilization on each channel over a time interval. The channel utilization includes the utilization due to Wi-Fi as well as utilization due to non-Wi-Fi interferers and Adjacent Channel Interference (ACI).



For additional information on how the spectrum analysis feature measures ACI, see [Channel Metrics on page 701](#).

This graph can show data recorded for the last ten, thirty, or sixty minutes. Spectrum monitors display spectrum analysis data seen on all channels in the selected band, and hybrid APs display data from the one channel they are monitoring. When you hover your mouse over any line in the chart, a tooltip shows the percentage of the channel being utilized at the specified time.

Click the down arrow in the upper right corner of this chart, then click the **Options** menu to access these configuration settings. Once you have configured the desired parameters, click **OK** at the bottom of the **Options** menu to save your settings and return to the spectrum dashboards.

**Table 141:** Channel Utilization Trend Options

Parameter	Description
Intervals	The Channel Utilization Trend chart shows channel quality or channel availability for the past 10 minutes by default. To view data for a different time range, click the <b>Intervals</b> drop-down list and select one of the following options: <ul style="list-style-type: none"> <li>• 10 minutes</li> <li>• 30 minutes</li> <li>• 1 hour</li> </ul>
Band	Radio band displayed in this graph (2.4 GHz or 5 GHz).
Channel Numbering	This parameter is not configurable for graphs created by hybrid APs or spectrum monitor radios that use the 2.4 GHz radio band. A hybrid AP on a 20 MHz channel sees 40 MHz Wi-Fi data as non-Wi-Fi data. For spectrum monitors using the 5 GHz radio band, click the <b>Channel Numbering</b> drop-down list and select either <b>20 MHz</b> or <b>40 MHz</b> channel numbering to identify a channel numbering scheme for the graph. Graphs for AP radios that support 802.11ac include an additional <b>80MHz</b> option for very-high-throughput channels.
Show	To select individual channels you want to display on this chart, click the check box by a channel entry, then click the <b>channel</b> drop-down list to select the channel to display. To hide a channel, uncheck the check box by that channel number.

## Device Duty Cycle

The Device Duty Cycle Chart is a stacked bar chart that shows the duty cycle of each device type on a channel. The duty cycle is the percentage of time each device type operates or transmits on that channel. Though Wi-Fi devices do not transmit if there is another Wi-Fi or non-Wi-Fi device active at that time, most non-Wi-Fi devices do not follow such a protocol for transmissions. Because these devices operate independently without regard to any other devices operating on the same channel, the total duty cycle of all device types may add up to more than 100% on a channel. For example, one or more video bridges may be active on a channel, each with a 100% duty cycle. The same channel may have a cordless transmitter with a 10% duty cycle and a microwave oven with a 50% duty cycle. In this example, the Device Duty Cycle chart shows all three device types with their respective duty cycle percentages.



A hybrid AP on a 20 MHz channel will see 40 MHz Wi-Fi data as non-Wi-Fi data.

Spectrum monitors display spectrum analysis data seen on all channels in the selected band, and hybrid APs display data from the one channel they are monitoring. The example below shows data from a spectrum monitor monitoring all channels in the 2.4 GHz band.



Click the down arrow in the upper right corner of this chart, then click the **Options** menu to access these configuration settings. Once you have configured the desired parameters, click **OK** at the bottom of the **Options** menu to save your settings and return to the spectrum dashboards.

**Table 142:** *Device Duty Cycle Options*

Parameter	Description
Band	Radio band displayed in this graph.  For spectrum monitor radios using the 5 GHz radio band, click the <b>Band</b> drop-down list and select <b>5 GHz upper</b> , <b>5 GHz middle</b> or <b>5 GHz lower</b> to display data for that portion of the 5 GHz radio band. This parameter is not configurable for graphs created by hybrid APs or spectrum monitor radios that use the 2.4 GHz radio band.
Channel Numbering	This parameter is not configurable for graphs created by hybrid APs or spectrum monitor radios that use the 2.4 GHz radio band. A hybrid AP on a 20 MHz channel sees 40 MHz Wi-Fi data as non-Wi-Fi data. For spectrum monitors using the 5 GHz radio band, click the <b>Channel Numbering</b> drop-down list and select either <b>20 MHz</b> or <b>40 MHz</b> channel numbering to identify a channel numbering scheme for the graph. Graphs for AP radios that support 802.11ac include an additional <b>80 MHz</b> option for very-high-throughput channels.
Channel Range	For graphs created by spectrum monitors, specify a channel range to determine which channels appear in this graph. Click the first drop-down list to select the lowest channel in the range, then click the second drop-down list to select the highest channel to appear in the graph.  This graph displays all channels within the spectrum monitor's radio band by default.  <b>NOTE:</b> This parameter is not configurable for graphs created by hybrid APs.

## Devices vs Channel

This stacked bar chart shows the current number of devices using each channel in the radio's frequency band. This chart can show separate per-channel statistics for the numbers of Wi-Fi devices, cordless phones, bluetooth devices, microwaves, and other non-Wi-Fi devices.

If a device affects more than one channel, it is recorded as a device on all channels it affects. For example, if a 20Mhz Wi-Fi AP has a center frequency of 2437 Mhz (channel 6) it is counted as a device on channels 3-9 because it affects all those channels. Similarly, if a channel-hopping device uses all channels within a frequency band, it is counted as a device on all channels in that band.

When you hover the mouse over any part of the chart, a tooltip shows the numbers of the device type currently using that channel.

Click the down arrow in the upper right corner of this chart, then click the **Options** menu to access these configuration settings. Once you have configured the desired parameters, click **OK** at the bottom of the **Options** menu to save your settings and return to the spectrum dashboards.

**Table 143: Devices vs Channel Options**

Parameter	Description
Band	Radio band displayed in this graph.  For spectrum monitor radios using the 5 GHz radio band, click the <b>Band</b> drop-down list and select <b>5 GHz upper</b> , <b>5GHz middle</b> or <b>5Ghz lower</b> to display data for that portion of the 5 Ghz radio band. This parameter is not configurable for graphs created by hybrid APs or spectrum monitor radios that use the 2.4 GHz radio band.
Channel Numbering	This parameter is not configurable for graphs created by hybrid APs or spectrum monitor radios that use the 2.4 GHz radio band. A hybrid AP on a 20 MHz channel sees 40 MHz Wi-Fi data as non-Wi-Fi data. For spectrum monitors using the 5 GHz radio band, click the <b>Channel Numbering</b> drop-down list and select either <b>20 MHz</b> or <b>40 MHz</b> channel numbering to identify a channel numbering scheme for the graph. Graphs for AP radios that support 802.11ac include an additional <b>80MHz</b> option for very-high-throughput channels.
Channel Range	For graphs created by spectrum monitors, specify a channel range to determine which channels appear in this graph. Click the first drop-down list to select the lowest channel in the range, then click the second drop-down list to select the highest channel to appear in the graph.  This graph displays all channels within the spectrum monitor's radio band by default.  <b>NOTE:</b> This parameter is not configurable for graphs created by hybrid APs.

### FFT Duty Cycle

The FFT Duty Cycle chart is a line chart that shows the duty cycle for each frequency bin. The width of the each frequency bin depends on the resolution bandwidth of the spectrum monitor. The spectrum analysis feature considers a frequency bin to be used if the detected power in that bin is at least 20 dB higher than the nominal noise floor on that channel. The FFT Duty Cycle provides a more granular view of the duty cycle per bin as opposed to the aggregated channel utilization reported in the Channel Metrics chart.



---

A hybrid AP on a 20 MHz channel will see 40 MHz Wi-Fi data as non-Wi-Fi data.

---

This chart can show the duty cycle over the last second, the maximum FFT duty cycle measured for all samples taken over the last N sweeps, and the greatest FFT duty cycle recorded since the chart was last reset.

Click the down arrow in the upper right corner of this chart, then click the **Options** menu to access these configuration settings. Once you have configured the desired parameters, click **OK** at the bottom of the **Options** menu to save your settings and return to the spectrum dashboards.

**Table 144: FFT Duty Cycle Options**

Parameter	Description
Band	Radio band displayed in this graph.  For spectrum monitor radios using the 5 GHz radio band, click the <b>Band</b> drop-down list and select <b>5 GHz upper</b> , <b>5GHz middle</b> or <b>5Ghz lower</b> to display data for that portion of the 5 Ghz radio band. This parameter is not configurable for graphs created by hybrid APs or spectrum monitor radios that use the 2.4 GHz radio band.
Channel Numbering	This parameter is not configurable for graphs created by hybrid APs or spectrum monitor radios that use the 2.4 GHz radio band. A hybrid AP on a 20 MHz channel sees 40 MHz Wi-Fi data as non-Wi-Fi data. For spectrum monitors using the 5 GHz radio band, click the <b>Channel Numbering</b> drop-down list and select either <b>20 MHz</b> or <b>40 MHz</b> channel numbering to identify a channel numbering scheme for the graph. Graphs for AP radios that support 802.11ac include an additional <b>80MHz</b> option for very-high-throughput channels.
X-Axis	Select either <b>Channel</b> or <b>Frequency</b> to show the duty cycle for a range of channels or frequencies.
Channel Range	If you selected <b>Channel</b> in the <b>X-Axis</b> parameter, you must also specify a channel range to determine which channels appear in the x-axis of this chart. Click the first drop-down list to select the lowest channel in the range, then click the second drop-down list to select the highest channel to appear in the chart.  <b>NOTE:</b> This parameter is not configurable for graphs created by hybrid APs.
Y-Axis	Select either <b>Frequency</b> or <b>Channel</b> to show the duty cycle for a range of frequencies or channels.
Show	Select a check box to display that information on the FFT Duty Cycle chart. <ul style="list-style-type: none"> <li>• <b>Duty Cycle:</b> The percentage of duty cycle the channel or frequency was actively used.</li> <li>• <b>Max Hold:</b> The maximum recorded percentage of active duty cycles for the channel frequency since the chart was last reset. To clear this setting, click the down arrow at the end of the title bar for this graph and select <b>Reset MaxHold</b>.</li> <li>• <b>Max of last sweeps:</b> This chart shows the maximum percentage of active duty cycles for the channel of frequency recorded during the last 10 sweeps, by default. To change the number of sweeps used to determine this value, enter a number from 2 to 20, inclusive. To clear this setting, click the down arrow at the end of the title bar for this graph and select <b>Reset MaxNSweep</b>.</li> </ul>

## Interference Power

The Interference Power chart displays various power levels of interest, including the Wi-Fi AP with maximum signal strength, noise, and interferer types with maximum signal strength. The ACI displayed in the Interference Power Chart is the ACI power level based on the signal strength(s) of the Wi-Fi APs on adjacent channels. A higher ACI value in Interference Power Chart does not necessarily mean higher interference, because the AP that is contributing to the maximum ACI may or may not be very actively transmitting data to other clients at all times. The ACI power levels are derived from the signal strength of the beacons.

This chart displays the noise floor of each selected channel in dBm. The noise floor of a channel depends on the noise figure of the RF components used in the radio, temperature, presence of certain types of interferers or noise, and the width of the channel. For example, in a clean RF environment, a 20 MHz channel has a noise floor around -95 dBm and a 40 MHz channel has a noise floor around -92 dBm. Certain types of fixed-frequency continuous transmitters such as video bridges, fixed-frequency phones, and wireless cameras typically elevate the noise floor seen by the spectrum monitor. Other interferers such as frequency-hopping phones, Bluetooth, and Xbox may not affect the noise floor of the radio. A Wi-Fi radio can only reliably decode Wi-Fi signals that are a certain dB above the noise floor. Therefore estimating and understanding the actual noise floor of the radio is critical to understanding the reliability of the RF environment.

The chart also includes information about the AP on each channel with the highest power level. You can hover your mouse over an AP on the chart to view the AP's name, SSID, and current power level. The example below shows that the AP with the maximum power on channel 157 has the SSID **qa-ss**, and a power level of -55dBm.

Click the down arrow in the upper right corner of this chart then click the **Options** menu to access these configuration settings. Once you have configured the desired parameters, click **OK** at the bottom of the **Options** menu to save your settings and return to the spectrum dashboards.

**Table 145:** *Interference Power Options*

Parameter	Description
Band	Radio band displayed in this graph.  For spectrum monitor radios using the 5 GHz radio band, click the <b>Band</b> drop-down list and select <b>5 GHz upper</b> , <b>5GHz middle</b> or <b>5Ghz lower</b> to display data for that portion of the 5 GHz radio band. This parameter is not configurable for graphs created by hybrid APs or spectrum monitor radios that use the 2.4 GHz radio band.
Channel Numbering	This parameter is not configurable for graphs created by hybrid APs or spectrum monitor radios that use the 2.4 GHz radio band. A hybrid AP on a 20 MHz channel sees 40 MHz Wi-Fi data as non-Wi-Fi data. For spectrum monitors using the 5 GHz radio band, click the <b>Channel Numbering</b> drop-down list and select either <b>20 MHz</b> or <b>40 MHz</b> channel numbering to identify a channel numbering scheme for the graph. Graphs for AP radios that support 802.11ac include an additional <b>80MHz</b> option for very-high-throughput channels.
Channel Range	For graphs created by spectrum monitors, specify a channel range to determine which channels appear in this graph. Click the first drop-down list to select the lowest channel in the range, then click the second drop-down list to select the highest channel to appear in the graph.  This graph displays all channels within the spectrum monitor's radio band by default.  <b>NOTE:</b> This parameter is not configurable for graphs created by hybrid APs.

## Quality Spectrogram

This plot shows the channel quality statistics for selected range of channels or frequencies. This chart can also be configured to show channel availability, the percentage of each channel that is unused and available for additional traffic.

Channel Quality is a weighted metric derived from key parameters which include noise, non-Wi-Fi (interferer) utilization and duty-cycles and certain types of retries. Quality levels are indicated by a range of colors between dark blue, which represents a higher channel quality, and red, which represents a lower channel quality. Channel availability is indicated by a range of colors between dark blue, which represents 100% channel availability, and red, which represents 0% availability.



For additional information on interpreting an Aruba Spectrogram plot, see [Swept Spectrogram on page 711](#).

The Spectrum Analysis Quality Spectrogram chart measures channel data each second, so after every 5-second sweep, the newest data appears as a thin colored line on the bottom of the chart. Older data is pushed up higher on the chart until it reaches the top of the spectrogram and ages out. The example below shows the Aruba Quality Spectrogram chart after it has recorded over 1,500 seconds of FFT data.

When you hover your mouse over any part of the spectrogram, a tooltip shows the devices the spectrum monitor detected on that frequency, the BSSID of the device (if applicable), the power level of the device in dBm, the time the device was last seen by the spectrum monitor, and the channels affected by the device.

The following table describes the other optional parameters you can use to customize the Quality Spectrogram. Click the down arrow in the upper right corner of this chart, then click the **Options** menu to access these configuration settings. Once you have configured the desired parameters, click **OK** at the bottom of the **Options** menu to save your settings and return to the spectrum dashboards.

**Table 146:** *Quality Spectrogram Options*

Parameter	Description
Band	Radio band displayed in this graph.  For spectrum monitor radios using the 5 GHz radio band, click the <b>Band</b> drop-down list and select <b>5 GHz upper</b> , <b>5GHz middle</b> or <b>5GHz lower</b> to display data for that portion of the 5 GHz radio band. This parameter is not configurable for graphs created by hybrid APs or spectrum monitor radios that use the 2.4 GHz radio band.
Channel Numbering	This parameter is not configurable for graphs created by hybrid APs or spectrum monitor radios that use the 2.4 GHz radio band. A hybrid AP on a 20 MHz channel sees 40 MHz Wi-Fi data as non-Wi-Fi data. For spectrum monitors using the 5 GHz radio band, click the <b>Channel Numbering</b> drop-down list and select either <b>20 MHz</b> or <b>40 MHz</b> channel numbering to identify a channel numbering scheme for the graph. Graphs for AP radios that support 802.11ac include an additional <b>80MHz</b> option for very-high-throughput channels.
X-Axis	Select either <b>Channel</b> or <b>Frequency</b> to show the quality spectrogram for a range of channels or frequencies.
Channel Range	Specify a channel range to determine which channels appear in the x-axis of this chart. Click the first drop-down list to select the lowest channel in the range, then click the second drop-down list to select the highest channel to appear in the chart.  <b>NOTE:</b> This parameter is not configurable for graphs created by hybrid APs.
Color-Map Range	<i>If this chart is configured to show quality spectrogram</i> , the default color range on this chart represents values from 0 to 100.

## Real-Time FFT

The Real-time FFT chart displays the instantaneous Fast Fourier Transform (FFT) signature of the RF signal seen by the radio. The Fast Fourier Transform (FFT) converts an RF signal from time domain to frequency domain. The frequency domain representation divides RF signals into discrete frequency bins; small frequency ranges whose width depends on the resolution bandwidth of the spectrum monitor (that is, how many Hz are represented by a single signal strength value). Each frequency bin has a corresponding signal strength value.

Because there may be a large number of FFT signatures received by the radio every second, an algorithm selects one FFT sample to display in the Real-time FFT chart every second.



---

A hybrid AP on a 20 MHz channel will see 40 MHz Wi-Fi data as non-Wi-Fi data.

---

This chart can show an average for all samples taken over the last second, the maximum FFT power measured for all samples taken over ten channel sweeps, and the greatest FFT power recorded since the chart was last reset. When you hover your mouse over any line, a tooltip shows the power level and channel or frequency level represented by that point in the graph. When you hover your mouse over a frequency level (within the blue brackets on the graph), a tooltip shows the types of devices seen on that frequency, and each device's BSSID, power level, channels affected and the time the device was last seen by the spectrum monitor.

Click the down arrow in the upper right corner of this chart, then click the **Options** menu to access these configuration settings. Once you have configured the desired parameters, click **OK** at the bottom of the **Options** menu to save your settings and return to the spectrum dashboards.

**Table 147:** *Real-Time FFT Options*

Parameter	Description
Band	Radio band displayed in this graph.  For spectrum monitor radios using the 5 GHz radio band, click the <b>Band</b> drop-down list and select <b>5 GHz upper</b> , <b>5GHz middle</b> or <b>5Ghz lower</b> to display data for that portion of the 5 GHz radio band. This parameter is not configurable for graphs created by hybrid APs or spectrum monitor radios that use the 2.4 GHz radio band.
Channel Numbering	This parameter is not configurable for graphs created by hybrid APs or spectrum monitor radios that use the 2.4 GHz radio band. A hybrid AP on a 20 MHz channel sees 40 MHz Wi-Fi data as non-Wi-Fi data. For spectrum monitors using the 5 GHz radio band, click the <b>Channel Numbering</b> drop-down list and select either <b>20 MHz</b> or <b>40 MHz</b> channel numbering to identify a channel numbering scheme for the graph. Graphs for AP radios that support 802.11ac include an additional <b>80MHz</b> option for very-high-throughput channels.
X-Axis	Select either <b>Channel</b> or <b>Frequency</b> to show FFT power for a range of channels or frequencies. If you select <b>Frequency</b> , you must select the radio frequency on which this chart should center, and determine the span of frequencies for the graph.

Parameter	Description
Channel Range	<p>If you selected <b>Channel</b> in the <b>X-Axis</b> parameter, you must also specify a channel range to determine which channels appear in the X-axis of this chart. Click the first drop-down list to select the lowest channel in the range, then click the second drop-down list to select the highest channel to appear in the chart.</p> <p><b>NOTE:</b> This parameter is not configurable for graphs created by hybrid APs.</p>
Y-axis	Select the range of power levels, in -dBm, to appear in the y-axis of this chart. Enter the lower value in the right field, and the higher value in the left field.
Show	<p>Select the check box by the following items to display that information on the FFT Power chart.</p> <ul style="list-style-type: none"> <li>• <b>Average:</b> the average power level of all samples recorded during the last 10 sweeps.</li> <li>• <b>Maxthe</b> The highest power recorded during the last 10 channel sweeps.</li> <li>• <b>Max Hold:</b> the highest maximum power level recorded since the chart data was reset. To clear this setting, click the down arrow at the end of the title bar for this graph and select <b>Clear Max Hold</b>.</li> </ul>

## Swept Spectrogram

A spectrogram is a chart that shows how the density of the quantity being plotted varies with time. The spectrum analysis Swept Spectrogram chart plots real-time FFT Maximums, real-time FFT Averages, or the FFT Duty Cycle. In this swept spectrogram, the x-axis represents frequency or channel and the y-axis represents time. Each line in the swept spectrogram corresponds to the data displayed in the Real-Time FFT or FFT Duty Cycle chart.




---

A hybrid AP on a 20 MHz channel will see 40 MHz Wi-Fi data as non-Wi-Fi data.

---

The power or duty cycle values recorded in each sweep are mapped to a range of colors. In the average or maximum FFT power Swept Spectrogram charts, the signal strength levels are indicated by a range of colors between dark blue, which represents -90 dBm, and red, which represents a higher -50 dBm. The duty cycle Swept Spectrogram chart shows the percentage of the time tick interval that the selected channel or frequency was broadcasting a signal. These percentages are indicated by a range of colors between dark blue, which represents a duty cycle of 0% percent, and red, which represents a duty cycle of 100%.

A spectrogram plot is a complex chart that can display a lot of information. If you are not familiar with these types of charts, they may be difficult to interpret.

The spectrum analysis Swept Spectrogram measures FFT power levels or duty cycle data each second, so after every 1-second sweep, the newest data appears as a thin colored line on the bottom of the chart. Older data is pushed up higher on the chart until it reaches the top of the spectrogram and ages out.

Click the down arrow in the upper right corner of this chart, then click the **Options** menu to access these configuration settings. Once you have configured the desired parameters, click **OK** at the bottom of the **Options** menu to save your settings and return to the spectrum dashboards.

**Table 148: Swept Spectrogram Options**

Parameter	Description
Band	<p>Radio band displayed in this graph.</p> <p>For spectrum monitor radios using the 5 GHz radio band, click the <b>Band</b> drop-down list and select <b>5 GHz upper</b>, <b>5GHz middle</b>, or <b>5Ghz lower</b> to display data for that portion of the 5 Ghz radio band. This parameter is not configurable for graphs created by hybrid APs or spectrum monitor radios that use the 2.4 GHz radio band.</p>
Channel Numbering	<p>This parameter is not configurable for graphs created by hybrid APs or spectrum monitor radios that use the 2.4 GHz radio band. A hybrid AP on a 20 MHz channel sees 40 MHz Wi-Fi data as non-Wi-Fi data. For spectrum monitors using the 5 GHz radio band, click the <b>Channel Numbering</b> drop-down list and select either <b>20 MHz</b> or <b>40 MHz</b> channel numbering to identify a channel numbering scheme for the graph. Graphs for AP radios that support 802.11ac include an additional <b>80MHz</b> option for very-high-throughput channels.</p>
X-Axis	<p>Select either <b>Channel</b> or <b>Frequency</b> to show FFT power or duty cycles for a range of channels or frequencies. If you select <b>Frequency</b>, you must select the radio frequency on which this chart should center, and determine the span of frequencies for the graph.</p>
Channel Range	<p>If you selected <b>Channel</b> in the <b>X-Axis</b> parameter, you must also specify a channel range to determine which channels appear in the x-axis of this chart. Click the first drop-down list to select the lowest channel in the range, then click the second drop-down list to select the highest channel to appear in the chart.</p> <p><b>NOTE:</b> This parameter is not configurable for graphs created by hybrid APs.</p>
Color-Map Range	<p><i>If this chart is configured to show average or maximum FFT values</i>, the default color range on this chart represents values from -50dBm (red) to -90dBm (blue). If you would like the color range on this chart to represent a different range of FFT power levels, enter this range in the <b>from</b> and <b>to</b> entry blanks.</p> <p>For example, if you defined a color-map range from -60 to -80, then any FFT power level at or above -60 dBm appears as red, and any FFT power level at or below -80 appears blue. Only the channel or frequency qualities between -60 dBm and -80 dBm would be represented by gradiented colors within the color range.</p> <p><i>If this chart is configured to show the FFT duty cycle</i>, the default color range on this chart represents duty cycles from 0% (red) to 100% (blue). If you would like the color range on this chart to represent a different range of FFT duty cycle percentages, enter this range in the <b>from</b> and <b>to</b> entry blanks.</p> <p>For example, if you defined a color-map range from 25 to 75, then any FFT duty cycle at or below 25% appears as red, and any FFT duty cycle at or below 75% appears blue. Only the duty cycle levels between 25% and 75% would be represented by gradiented colors within the color range.</p> <p><b>NOTE:</b> If your swept spectrogram is showing a single color only, you may need to increase the color map range to display a greater range of values.</p>
Show	<p>Select <b>FFT Avg</b>, <b>FFT Max</b> or <b>FFT Duty Cycle</b> to select the type of data you want to appear in this chart.</p>



## Working with Non-Wi-Fi Interferers

The following table describes each type of non-Wi-Fi interferer detected by the spectrum analysis feature. These devices appear in the following charts:

- Active Devices
- Active Devices Table
- Active Devices Trend
- Device Duty Cycle
- Device vs Channel
- Interference Power

**Table 149: Non-Wi-Fi Interferer Types**

Non-Wi-Fi Interferer	Description
Bluetooth	Any device that uses the Bluetooth protocol to communicate in the 2.4 GHz band is classified as a <i>Bluetooth</i> device. Bluetooth uses a frequency hopping protocol.
Fixed Frequency (Audio)	Some audio devices such as wireless speakers and microphones also use fixed frequency to continuously transmit audio. These devices are classified as <i>Fixed Frequency (Audio)</i> .
Fixed Frequency (Cordless Phones)	Some cordless phones use a fixed frequency to transmit data (much like the fixed frequency video devices). These devices are classified as <i>Fixed Frequency (Cordless Phones)</i> .
Fixed Frequency (Video)	Video transmitters that continuously transmit video on a single frequency are classified as <i>Fixed Frequency (Video)</i> . These devices typically have close to a 100% duty cycle. These types of devices may be used for video surveillance, TV or other video distribution, and similar applications.
Fixed Frequency (Other)	All other fixed frequency devices that do not fall into one of the above categories are classified as <i>Fixed Frequency (Other)</i> . Note that the RF signatures of the fixed frequency audio, video and cordless phone devices are very similar, and that some of these devices may be occasionally classified as Fixed Frequency (Other).
Frequency Hopper (Cordless Base)	Frequency hopping cordless phone base units transmit periodic beacon-like frames at all times. When the handsets are not transmitting (i.e., no active phone calls), the cordless base is classified as <i>Frequency Hopper (Cordless Base)</i> .
Frequency Hopper (Cordless Network)	When there is an active phone call and one or more handsets are part of the phone conversation, the device is classified as <i>Frequency Hopper (Cordless Network)</i> . Cordless phones may operate in 2.4 GHz or 5 GHz bands. Some phones use both 2.4 GHz and 5 GHz bands (for example, 5 GHz for Base-to-handset and 2.4 GHz for Handset-to-base). These phones may be classified as unique Frequency Hopper devices on both bands.
Frequency Hopper (Xbox)	The Microsoft Xbox device uses a frequency hopping protocol in the 2.4 GHz band. These devices are classified as <i>Frequency Hopper (Xbox)</i> .

Non-Wi-Fi Interferer	Description
Frequency Hopper (Other)	When the classifier detects a frequency hopper that does not fall into one of the above categories, it is classified as <i>Frequency Hopper (Other)</i> . Some examples include IEEE 802.11 FHSS devices, game consoles, and cordless/hands-free devices that do not use one of the known cordless phone protocols.
Microwave	Common residential microwave ovens with a single magnetron are classified as a <i>Microwave</i> . These types of microwave ovens may be used in cafeterias, break rooms, dormitories and similar environments. Some industrial, healthcare or manufacturing environments may also have other equipment that behave like a microwave and may also be classified as a Microwave device.
Microwave (Inverter)	Some newer-model microwave ovens have inverter technology to control the power output and may have a duty cycle close to 100%. These microwave ovens are classified as <i>Microwave (Inverter)</i> . Dual-magnetron industrial microwave ovens with higher duty cycle may also be classified as Microwave (Inverter). As in the Microwave category described above, there may be other equipment that behave like inverter microwaves in some industrial, healthcare or manufacturing environments. Those devices may also be classified as Microwave (Inverter).
Generic Interferer	Any non-frequency hopping device that does not fall into one of the other categories described in this table is classified as a <i>Generic Interferer</i> . For example, a Microwave-like device that does not operate in the known operating frequencies used by the Microwave ovens may be classified as a Generic Interferer. Similarly, wide-band interfering devices may be classified as Generic Interferers.

## Understanding Spectrum Analysis Session Log

The spectrum analysis **Session Log** tab displays times the spectrum monitors and hybrid APs connected to or disconnected from the spectrum client during the current browser session. This tab also shows changes in a hybrid AP's scanning channel caused by changes to the hybrid AP's 802.11a or 802.11g radio profile or automatic channel changes by the DFS or ARM features. The latest entry in the session log is also displayed in a footer at the bottom of the Spectrum Monitors and Spectrum Dashboard window. When you close the browser and end your spectrum analysis session, the session log is cleared.

## Viewing Spectrum Analysis Data

You can use the command-line interface to view spectrum analysis data from any spectrum monitor, even if that spectrum monitor is currently sending data to another spectrum monitor client's WebUI.

[Table 150](#) shows the commands that display spectrum analysis data in the CLI interface.

**Table 150: Spectrum Analysis CLI Commands**

Command	Description
<code>show ap spectrum ap-list</code>	Shows spectrum data seen by an access point that has been converted to a spectrum monitor.
<code>show ap spectrum channel-metrics</code>	Shows channel utilization information for a 802.11a or 802.11g radio band, as seen by a spectrum monitor
<code>show ap spectrum channel-summary</code>	Displays a summary of the 802.11a or 802.11g channels seen by a spectrum monitor.
<code>show ap spectrum client-list</code>	Shows details for Wi-Fi clients seen by a specified spectrum monitor.
<code>show ap spectrum debug</code>	Sub-commands under this command save spectrum analysis channel information to a file on the stand-alone controller.
<code>show ap spectrum device-duty-cycle</code>	Shows the current duty cycle for devices on all channels being monitored by the spectrum monitor radio.
<code>show ap spectrum device-history</code>	Displays spectrum analysis history for non-interfering devices.
<code>show ap spectrum device-list</code>	Shows summary table and channel information for non-Wi-Fi devices currently seen by the spectrum monitor.
<code>show ap spectrum device-log</code>	Shows a time log of add and delete events for non-Wi-Fi devices.
<code>show ap spectrum device-summary</code>	Shows the numbers of Wi-Fi and non-Wi-Fi device types on each channel monitored by a spectrum monitor.
<code>show ap spectrum interference-power</code>	Shows the interference power detected by a 802.11a or 802.11g radio on a spectrum monitor.
<code>show ap spectrum monitors</code>	Shows a list of APs currently configured as spectrum monitors.
<code>show ap spectrum technical-support</code>	Saves spectrum data for later analysis by your Aruba technical support representative.

## Recording Spectrum Analysis Data

The spectrum analysis tool allows you to record up to 60 continuous minutes (or up to 10 Mb) of spectrum analysis data. By default, each spectrum analysis recording displays data for the Real-Time FFT, FFT Duty Cycle, Interference Power and Swept Spectrogram charts, however, you can view recorded device data for any the spectrum analysis charts supported by that spectrum monitor radio. Configurable recording settings allow you to start a recording session immediately, or schedule a recording to begin at a later date and time. Each recording can be scheduled to end after a selected amount of time has passed, or continue on until the

recorded data file reaches a specified size. You can save the file to your spectrum monitor client, then play back that data at a later time.

## Creating a Spectrum Analysis Record

To record spectrum analysis data for later analysis:

1. In the **Mobility Master** node hierarchy, navigate to **Diagnostics > Tools > Spectrum Analysis**.
2. Click **Launch** to launch the Spectrum Analysis tool.
3. Click the **Spectrum Monitors** tab in the new window.
4. Click **Record** at the top of the window. The **New Recording** popup window appears.
5. Click the **Record From** link, and select the spectrum monitor whose data you want to record.
6. Next, decide whether you want the recording to start immediately, or at a later scheduled time. If you want the recording to start immediately, select **When the OK button is clicked**. To schedule a different starting time for the recording, click the date and time drop-down lists to select a starting month, day, year and time.
7. The recording continues until either the specified amount of time has passed, or until the recording files reaches a selected size. Click the **Length of recording reaches** drop-down list and select the amount of time the recording should last, or click the **Data file reaches** drop-down list and select the maximum file size for the recording.
8. Click **OK** to save your settings. If you selected the **When the OK button is clicked** in step 5, the recording begins.

While the recording is in progress, a round, red recording icon and recording status information appears at the top of the spectrum dashboard. You can view data for other spectrum monitors and charts while the recording is in progress. If you want to stop the recording before recording period has finished, click **Stop** by the recording status information. When you the **Stop**, a popup window appears and allows you to stop and delete the current recording, stop and save the recording in its current state (before it has completed), or continue recording again.

## Saving Recording

After the recording has ended, either because the recording period has elapsed, the recording maximum file size has been reached, the **Spectrum Monitor Recording Complete** window appears and displays information for the current recording.

To save the recording file:

1. From the **Spectrum Monitor Recording Complete** window, click **Continue**.
2. A **Save As** window appears and prompts you to select a file name for the recording and a location to save the file.
3. Click **Save**.

## Playing Spectrum Analysis Recording

There are two ways to play back a spectrum recording. You can use the playback feature in the spectrum dashboard, or view recordings using the Aruba RFPlayback tool downloaded from the Aruba website.

### Playing Recording in Spectrum Dashboard

The spectrum monitor does not have to be subscribed to your spectrum analysis client in order to play back a recording in the spectrum dashboard. However, you cannot play back an existing recording in the spectrum dashboard while another recording session is currently in progress.

To play a spectrum analysis recording in the spectrum dashboard:

1. In the **Mobility Master** node hierarchy, navigate to **Diagnostics > Tools > Spectrum Analysis**.
2. Click **Launch** to launch the Spectrum Analysis tool.
3. Click the **Spectrum Dashboards** tab.
4. Click **Load File for Playback**.
5. An **Open** dialog box appears and prompts you to browse to and select the file you want to open.
6. Click **Open**.
7. Click the triangular play icon at the top of the window to start playing back the recording.

Recorded data for the selected spectrum monitor and dashboard view appears in the spectrum analysis dashboard. You can replace any of the graphs in the playback window with a different graph type while replaying the recording. A playback progress bar at the top of the window shows what part of the recording currently appears on the dashboard. If you pause the recording, you can click and drag the red slider on this progress bar to advance to or replay any part of the current record.

### Playing Recording Using RFPlayback Tool

The Aruba RFPlayback tool can play spectrum recordings created in this and earlier versions of ArubaOS. Aruba uses the Adobe AIR application to display spectrum recording information. If you have not done so already, follow the steps below to download and install the free Adobe AIR application and the Aruba spectrum playback tool.

1. Download the Adobe Air application from <http://get.adobe.com/air/> and install it on the client on which you want to play spectrum recordings.
2. Next, download the spectrum playback installation file from the Aruba website.
3. Open the folder containing the spectrum installation file, and double-click the spectrum.air icon to install the spectrum playback tool. You will be prompted to select the folder in which you want to install this tool.

Once you have installed the Aruba RFPlayback tool, follow the steps below to load and view a spectrum recording.

1. Start the Spectrum playback application.
2. Click **Load File for Playback**. An **Open** dialog box appears and prompts you to browse to and select the file you want to open.
3. Click the triangular play icon at the top of the window play the recording.

The RFPlayback tool also allows you to select and display different graph types while the recording playback is in progress. A playback progress bar at the top of the window shows what part of the recording is displayed in the playback tool. If you pause the recording, you can click and drag the red slider on this progress bar to advance to or replay any part of the current record.

## Troubleshooting Spectrum Analysis

### Verifying Spectrum Monitors Support for One Client per Radio

Each spectrum monitor radio can only send information to one client at a time. If you log into a stand-alone controller and the spectrum monitor dashboard does not display any data for the selected radio, another user may be logged in to the stand-alone controller at that time. Note that dual-radio spectrum monitors may be accessed by two clients; one client for each radio.

### Converting a Spectrum Monitor Back to an AP or Air Monitor

If want to convert a spectrum monitor radio back to AP or AM mode but the radio still comes up as a spectrum monitor, access the command-line interface and see if that spectrum monitor appears in the output of the

**show ap spectrum local-override** command. If the spectrum monitor does appear in the local override profile table, issue the command **ap spectrum local-override no override ap-name <apame> spectrum-band <spectrum-band>** to remove the local override for that spectrum monitor and return the radio to AP or AM mode.

## Troubleshooting Browser Issues

If you access the spectrum analysis dashboard using the Safari 5.0 browser, clicking the backspace button may return you to the previous browser screen. Avoid using the backspace button when changing dashboard view names or chart options.

If you are recording spectrum analysis data or playing back a spectrum analysis recording using a Mac client, do not minimize the browser window while the recording is in progress, as that may cause the Adobe Flash player to pause.

## Loading a Spectrum View

Saved spectrum view preferences may not be backwards compatible with the spectrum analysis dashboard in earlier versions of ArubaOS. If you downgrade to an earlier version of ArubaOS and your client is unable to load a saved spectrum view in the spectrum dashboard, access the CLI in enable mode and issue the command **ap spectrum clear-webui-view-settings** to delete the saved spectrum views and display default view settings in the spectrum dashboard.

## Troubleshooting Issues with Adobe Flash Player 10.1 or Later

Removing focus from the browser window displaying the spectrum analysis dashboard may cause Adobe Flash 10.1 or later to stop updating the spectrum charts to reduce CPU usage. When you restore focus to the spectrum analysis dashboard, you may see the spectrum charts update rapidly as the display catches up. Recorded data may be inaccurate if you navigate away from the spectrum window during a recording. Flash 10.0 does not have this issue.

## Understanding Spectrum Analysis Syslog Messages

The spectrum analysis feature can send four different types of syslog messages: wifi add, wifi delete, non-wifi add, and non-wifi delete. All messages are in the wireless category at the syslog severity level NOTICE.

The four syslog message types appear in the following formats:

- AM: Spectrum: new wifi device found = [addr:%s] SSID = [ssid:%s] BSSID [bssid\_str:%s] DEVICE ID [did:%d]
- AM: Spectrum: deleting wifi device = [addr:%s] SSID = [ssid:%s] BSSID [bssid\_str:%s] DEVICE ID [did:%d]
- AM: Spectrum: new non-wifi device found = DEVICE ID [did:%u] Type [dtype:%s] Signal [sig:%u] Freq [freq:%u]KHz Bandwidth [bw:%u]KHz
- AM: Spectrum: deleting non-wifi device = DEVICE ID [did:%d] Type [dtype:%s]

## Playing a Recording in the RFPlayback Tool

The Aruba RFPlayback tool is periodically updated to support improvements to the ArubaOS Spectrum Analysis feature. The RFPlayback tool can play spectrum recordings created in the same version of ArubaOS or earlier releases. If the RFPlayback tool cannot load a newer recording, you may need to download a more recent version of the tool from the Aruba website.

The **Dashboard** page provides an enhanced visibility into your wireless network to view and monitor various information of the devices in the network.

Additionally, you can view the context sensitive help for each field in the **Dashboard** UI by clicking the **help** link at the top-right corner of the WebUI. The field for which the help is defined appears as green. You can turn off the help by clicking **Done**.



---

You can use the **Search** functionality to find the matched results for clients, APs, and WLANs. Click the count in the search results of clients, APs, and WLANs to navigate to the related summary page with the filters applied.

---

The ArubaOS 8.0.0.0 adds the Mobility Master and managed device in a topology that permits the Mobility Master to manage and monitor one or more managed device. For this, the administrator has to configure mgmt-server as the Mobility Master from the managed device's path. The Mobility Master can only manage and monitor managed devices and cannot manage APs.

Dashboard is supported in the following mode:

- [Dashboard in Mobility Master Mode on page 719](#)
- [Dashboard in Master Controller Mode on page 719](#)

## Dashboard in Mobility Master Mode

In the **Managed Network** node hierarchy, navigate to **Dashboard** visibility into your wireless network.

The centralized visibility feature is supported in this mode, which means, you can view the **Dashboard** of a managed device without logging out of the Mobility Master. To view the **Dashboard** page of a managed device, click the managed device. See [Table 151](#) for dashboard pages available in managed network and managed device.

## Dashboard in Master Controller Mode

ArubaOS 8.0.1.0 introduces master controller mode, and the dashboard feature is supported in this mode.

The centralized visibility feature is not supported in the master controller mode, which means, you cannot view the **Dashboard** of a managed device from the master controller. To view the **Dashboard** page of a managed device, login to the managed device. See [Table 151](#) for dashboard pages available in master controller and managed device.

## Dashboard Pages

The following table shows the dashboard pages available in Mobility Master and master controller mode:

**Table 151: Dashboard Pages in Various Views**

Dashboard Pages	Mobility Master Mode		Master Controller Mode	
	Managed Network	Managed Device	Master Controller	Managed Device
<a href="#">WAN</a>	—	Yes	—	Yes
<a href="#">Performance</a>	Yes	Yes	—	Yes
<a href="#">Network</a>	Yes	Yes	Yes	—
<a href="#">Cluster</a>	Yes	—	—	—
<a href="#">Usage</a>	Yes	Yes	—	Yes
<a href="#">Potential Issues</a>	Yes	Yes	—	Yes
<a href="#">Traffic Analysis</a>	Yes	Yes	—	Yes
<a href="#">AirGroup</a>	Yes	Yes	—	Yes
<a href="#">Security</a>	Yes	—	Yes	—
<a href="#">UCC</a>	Yes	Yes	—	Yes
<a href="#">Controller</a>	Yes	Yes	Yes	Yes
<a href="#">WLANS</a>	Yes	Yes	—	Yes
<a href="#">Access Points</a>	Yes	Yes	Yes	Yes
<a href="#">Clients</a>	Yes	Yes	Yes	Yes

## WAN

This page is available only when logged in to the managed device. This dashboard is the default landing page for a managed device with uplinks defined via the [Uplink Monitoring and Load Balancing on page 223](#). The WAN dashboard does not appear in the Mobility Master and master controller WebUI.



For more information on defining a WAN uplink, see [Uplink Monitoring and Load Balancing on page 223](#). For information on enabling and the uplink health check features, see [Health Check Services for Managed Devices on page 220](#).

The WAN dashboard provides the WAN summary details for uplink VLANs, and contains the following tables:

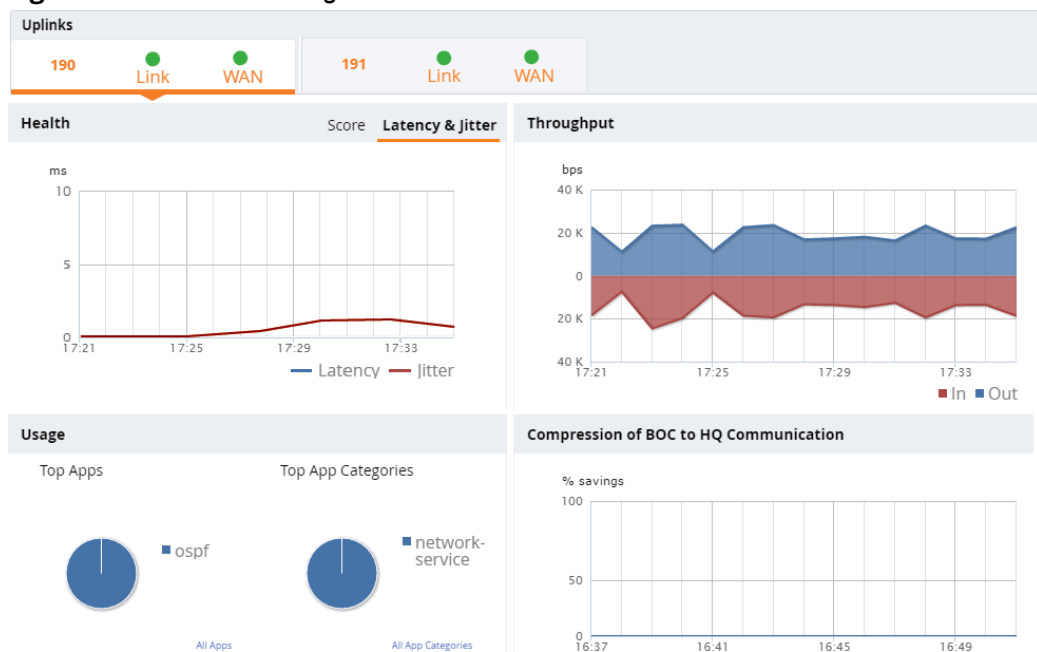
- **Uplinks:** This section displays the **link** status and **WAN** status for VLANs monitored using the uplink manager utility. For each VLAN, the green check mark icon indicates an up status and red down arrow represents a down status for the link and WAN. The [Health Check Services for Managed Devices on page](#)



[220](#) is disabled by default on managed devices. If it is enabled, the WAN status link will appear with a yellow icon, indicating that this feature is in an error state.

- **Health:** This table displays statistics showing the general health of the uplink. If jitter is not enabled, health score is not measured.
  - **Score:** The health score rates the health of the uplink on a scale of 1-5, with score of 1 being lower quality and a score of 5 being the highest quality. These scores are based upon the latency and jitter rates, and packet loss.
  - **Latency & Jitter:** Jitter is a variation in the inter-packet delay of received packets. If the **jitter measurement** option is enabled in the uplink manger, the uplink manger uses UDP packets on UDP port 4500 to measure jitter on the WAN links, and includes jitter statistics in the uplink quality calculations. Jitter statistics will not be measured if jitter measurement is not enabled in the uplink manager settings. For details on enabling and disabling uplink jitter measurements, see [Uplink Monitoring and Load Balancing on page 223](#).
- **Throughput:** Displays the inbound and outbound traffic rates between managed device and VPN concentrator for the selected uplink.
- **Usage:** Displays relative proportions of traffic types based on Application Category or Application.
- **Compression:** Displays the aggregate percentage compression on all VLANs with the compression feature enabled.

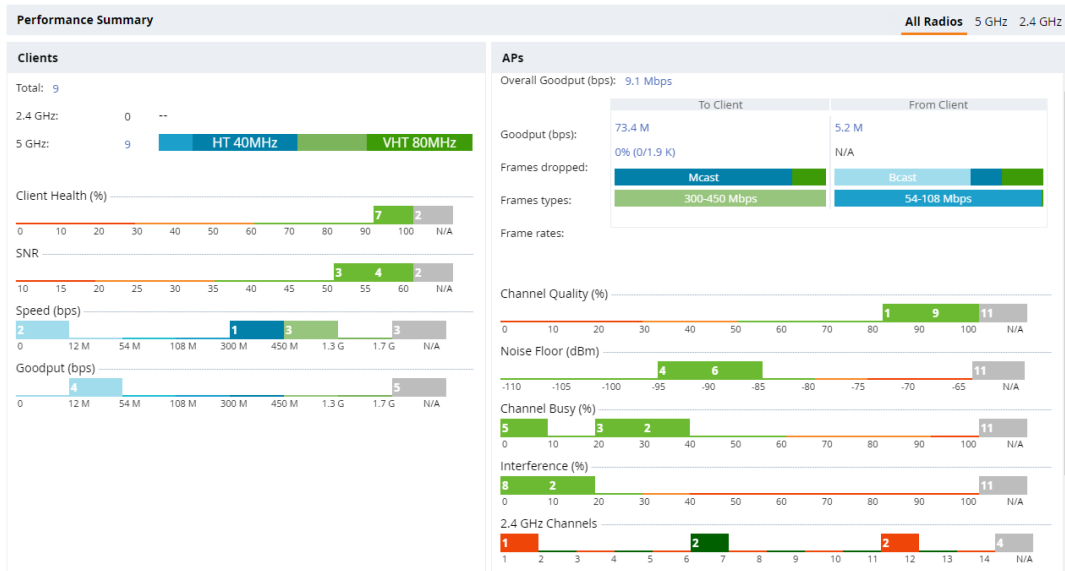
**Figure 53** WAN Monitoring Dashboard



## Performance

The **Performance** page displays the performance details of the wireless clients and APs connected to the network or managed device, as shown in the following figure:

**Figure 54 Performance Page**



The three views available in this page are the following:

- All Radios— Displays the performance of all clients and APs
- 5 GHz— Displays the performance of 5 GHz supported client and APs
- 2.4 GHz— Displays the performance of 2.4 GHz supported client and APs

## Clients

This section displays the total number of wireless clients connected in the network. The administrator can see a top level view of the wireless clients, and further drill down into a specific managed device to view the wireless client connected to it. You can view the distribution of clients in different client health ranges, SNR ranges, associated data rate ranges, and data transfer speed ranges using the histograms and distributed charts. You can click on the hyperlinked number to view the data in different screens with histograms.

An AP's client health is the efficiency at which that AP transmits downstream traffic to a particular client. This value is determined by comparing the amount of time the AP spends transmitting data to a client to the amount of time that would be required under ideal conditions, that is, at the maximum Rx rate supported by client, with no data retries.

A client health metric of 100% means the actual airtime the AP spends transmitting data is equal to the ideal amount of time required to send data to the client. A client health metric of 50% means the AP is taking twice as long as is ideal, or is sending one extra transmission to that client for every packet. A metric of 25% means the AP is taking four times longer than the ideal transmission time, or sending 3 extra transmissions to that client for every packet.

To understand histogram information, see [Dashboard Histograms on page 723](#).

## APs

This section displays the following performance details of the APs on the Mobility Master:

- Overall goodput (bps)— Displays the ratio of the total bytes transmitted or received in the network to the total air time required for transmitting or receiving the bytes.
- Goodput (bps)— Displays the ratio of total bytes transmitted to client or received from client to the total air time required for transmitting or receiving

- **Frames dropped**— Displays the percentage of frames dropped when transmitted to client and received from client
- **Frame types**— Displays the type of frame (broadcast, multicast, unicast) transmitted to client or received from client
- **Frame rates**— Displays the range of frame rates transmitted to Client or received from Clients in Mbps
- **Channel Quality (%)**— Displays the total number of radios per channel quality in percentage
- **Noise Floor (dBm)**— Displays the total number of radios per noise floor (dBm) range
- **Channel Busy (%)**— Displays the total number of radios per channel busy in percentage
- **Interference (%)**— Displays the total number of radios per Interference in percentage
- **2.4 GHz Channels**— Displays the number of radios using each channel of the 2.4 GHz spectrum
- **5 GHz Channels**— Displays the number of radios using each channel of the 5 GHz spectrum
- **EIRP (dBm)**— Displays the number of radios per EIRP level

You can click the hyperlinked text and histograms to view the AP specific performance information as a trend chart. Additionally, you can view the distribution of the APs in different noise floor ranges, channel utilization ranges, and non-Wi-Fi interference ranges using the histograms. To understand histogram information, see [Dashboard Histograms on page 723](#) .

## Dashboard Histograms

Dashboard histograms are a visual representation of the distribution of the wireless clients, access points, and radios across different performance parameters in the Mobility Master. Histograms help you to quickly identify any performance issues in the network from the color of the distribution. For example, critical ranges of the distribution are highlighted in red and normal ranges are highlighted in green.

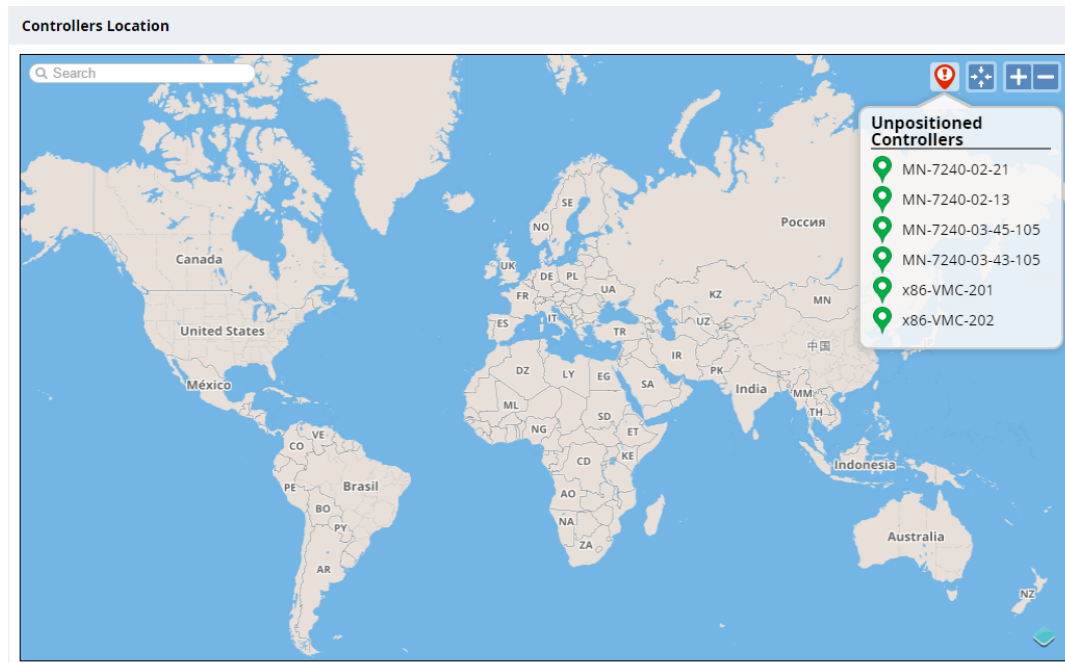
You can view the number of clients or APs falling in each range of the distribution with a hyperlink. You can also perform the following tasks on the histograms to get additional information on the clients and APs in the distribution:

- **View Client or AP details**—Click the hyperlinked number to view the details of the clients or APs in a pop-up window.
- **Sort**—Click a column header of the clients or APs table to sort the complete list based on the entries on the active column. You can also use the sort icon that appears when you click on a column for sorting.
- **Filter**—Click the filter icon and select the filter criterion on any column to filter the entries.
- **Close pop-up window**—Click on the close icon to close the client or AP details pop-up window.

## Network

This page contains the world map. The map displays the location of the managed devices in the network. If a managed device is not positioned, it is listed in a red balloon in the top-right corner of the map as shown in the following figure:

Figure 55 Network Page



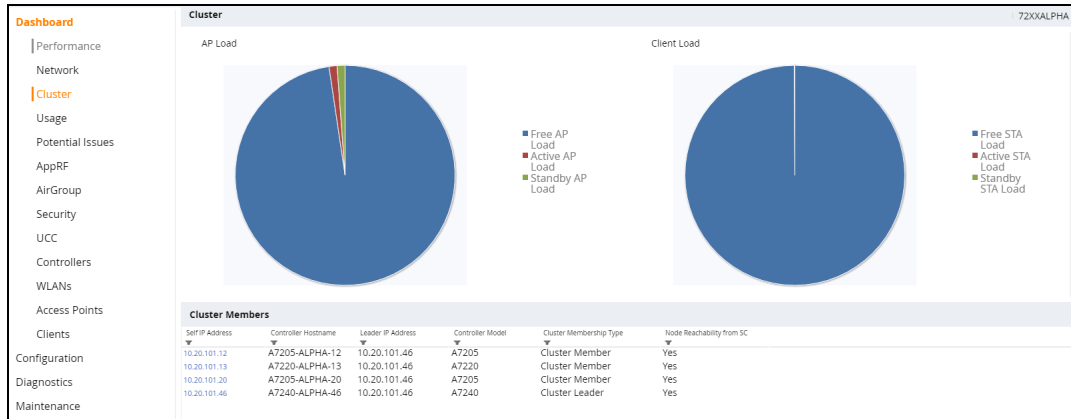
## Cluster

The **Cluster** dashboard provides a visual overview on each cluster deployed on the network, displaying the following information:

- Health information between cluster members
- Total AP load per Cluster
- Total User load per Cluster
- Connection time

The **Cluster** dashboard can only be accessed from the root (Managed Network) node of the Mobility Master hierarchy. This information is not displayed on any stand-alone controllers, managed devices, or other nodes in the hierarchy. To view the **Cluster** dashboard, navigate to **Dashboard > Cluster** in the WebUI. By default, the **Cluster** dashboard displays an overview for the first cluster under the drop-down list. The dashboard displays total AP load and total client load. To view information on a different cluster, click the drop-down list at the right-hand corner, and then select the desired cluster name.

**Figure 56** *The Cluster Dashboard*



The **Cluster** dashboard consists of an **Cluster** section and **Cluster Member** section. The **Cluster** dashboard contains the following graphs and tables:

- Cluster > AP Load:** Displays the proportional distribution and number of active, standby, and free APs. Hover your mouse above a section of the pie chart to view the count for that AP type:
  - Free AP Load
  - Active AP Load
  - Standby AP Load
- Cluster > Client Load:** Displays the proportional distribution and number of active, standby, and free stations (clients). Hover your mouse above a section of the pie chart to view the count for that station type:
  - Free STA Load
  - Active STA Load
  - Standby STA Load
- Cluster Members:** Displays the cluster member fields as described in [Table 152](#).

**Table 152:** *Cluster Member Fields*

Parameter	Description
Self IP Address	Self IP address of the cluster member
Controller Hostname	Host name of the cluster member
Leader IP Address	IP address of the cluster leader to which the cluster member is assigned
Controller Model	Controller model of the cluster member
Cluster Membership Type	Cluster membership type (leader or member)
Node Reachability from SC	Indicates whether the Cluster Member is reachable from Mobility Master

To view more in-depth information on a specific cluster member, select a member from the **Cluster Members** table and the cluster > cluster member details page is displayed. This page contains the following graphs and tables for the selected cluster member:

- **AP Load Pie:** Displays the proportional distribution of active, standby, and free APs for the selected cluster member. Hover your mouse above a section of the pie chart to view the count for that AP type.
- **Client Load:** Displays the proportional distribution of active, standby, and free stations (clients) for the selected cluster member. Hover your mouse above a section of the pie chart to view the count for that station type.
- **Cluster Members:** Displays the cluster member fields as described in [Table 153](#).

**Table 153:** *Cluster Members Fields For A Cluster*

Parameter	Description
Self IP Address	Self IP address of the cluster member.
Peer IP Address	IP address of the peer managed devices.
Connection Status	Connection status of the peer managed device.
Connection Type	Connection type between the cluster member and peer managed device (L2/L3).
Mismatch VLAN ID	Indicates any VLAN mismatches between the cluster member and peer managed device.
Disconnect Reason	Indicates why the peer managed device has disconnected from the cluster member.
Incompatible Reason	Indicates why the peer managed device is not compatible with the cluster member.
Latency - Round trip delay (Micro seconds)	
Min	Minimum latency.
Max	Maximum latency.
Avg	Average latency.

## Usage

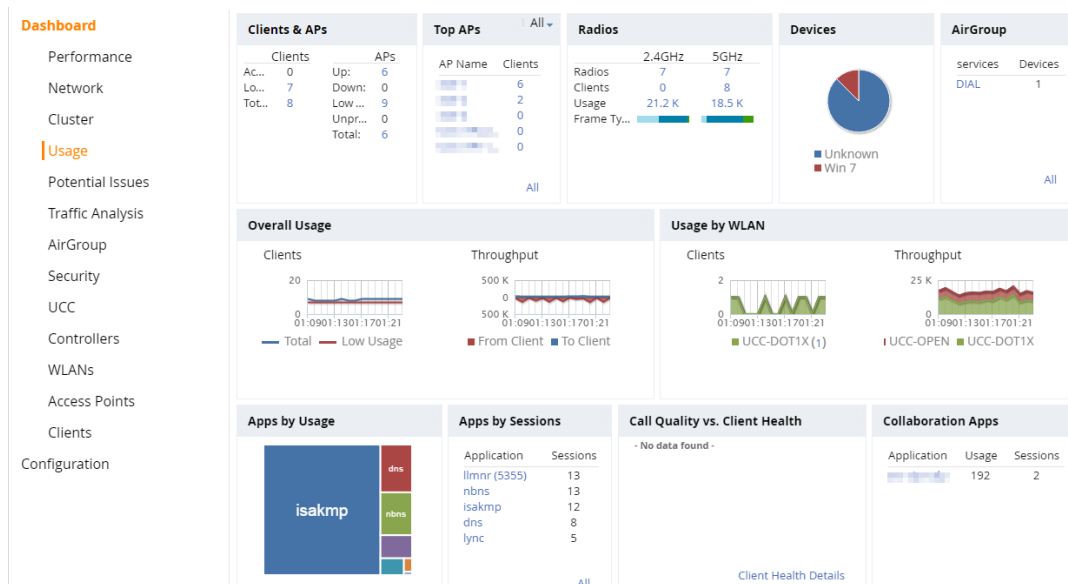
The **Usage** page displays the usage summary of the following on the managed devices in the network:

- **Clients & APs:** The active wireless clients, status of APs, and its usage.
- **Top APs:** The list of APs with the number of clients on the managed device. The list of APs is in the descending order based on the number of clients associated with an AP. You can filter the APs for the 2.4 GHz and 5 GHz radio band options.
- **Radios:** The radios and clients connected to an AP, usage, and frame types transmitted and received by the radio.
- **Devices:** The pie chart of the clients based on the device type. Clicking on the pie chart segment opens the client details page filtered on the device type.

- **AirGroup:** All the AirGroup services available and number of servers offering the service. It is aggregated by the total number of AirGroup servers sorted by the services they advertise. For more information, see [AirGroup on page 740](#).
- **Overall Usage:** The total number of clients and APs that have the low usage and throughput data in the last 15 minutes.
- **Usage by WLANs:** The total number of clients per WLAN and throughput data in the last 15 minutes. You can view only three WLANs in a graph and the remaining WLANs are displayed in other graph. Click the graph to view the blown up chart and information on the **Clients** page.
- **Apps by Usage:** The charts with the list of application based on the usage. You can click on the specific chart to view the application details in the **Traffic Analysis** page.
- **Apps by Sessions:** The list of top five applications with the session information in descending order.
- **Call Quality vs. Client Health:** This graph displays the co-relation between the VoIP call quality and the VoIP client health of every Unified Communication and Collaboration (UCC) call. For more information, see [UCC Dashboard on page 923](#).
- **Collaboration Apps:** The list of applications with sessions and usage details.

You can click the hyperlinked text in the sections above to view the lists and trend chart in the last 15 minutes and summary of the APs and clients in the new windows. For more information on the columns, you can view the context sensitive help for each field in the **Dashboard** UI by clicking the help link at the top right corner of the UI. The following figure shows the **Usage** page:

**Figure 57 Usage Page**



## Potential Issues

The **Potential Issues** page displays the total number of wireless clients and radios that may have potential issues in the network. You can click on the total number to view the trend of the clients and radios with potential issues in the last 15 minutes. You can also view the number of clients or radios that have a specific potential issue in each radio band.

The potential issues that a client may have are:

- **Low SNR:** clients that have signal to noise ratio of 30 dBm or lower.
- **Low speed:** clients that have a connection speed of 36 Mbps or lower.

- **Low goodput:** clients that have an average data rate of 24 Mbps or lower.

The potential issues that a radio may have are:

- **High noise floor:** radios that have a noise floor of -85 dB or greater.
- **Busy channel:** radios that have a channel utilization of 80% or greater.
- **High interference:** radios that have an interference of 20% or greater.
- **High client association:** radios that have 15 or more clients connected.

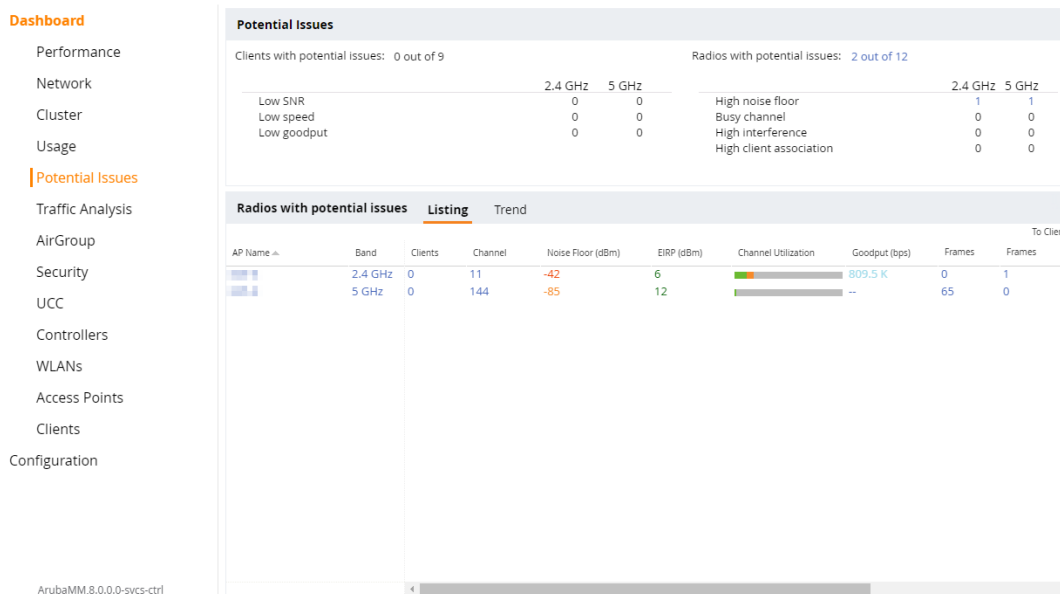
You can click on the hyperlinked number to view the details of the respective clients or radios in the bottom pane of the page in the **Clients with potential issues** or **Radios with potential issues** section. This section has two views, **Listing** and **Trend**.

The **Listing** view displays clients with potential issues as a list in a table format. You can sort by clicking a column header of the table based on the entries on the active column.

The **Trend** view displays the radios with potential issues in a chart.

The following figure shows the **Potential Issues** page:

**Figure 58** *Potential Issues Page*



## Traffic Analysis

The information in the **Traffic Analysis** page is by AppRF, an application visibility and control feature. AppRF performs Deep Packet Inspection (DPI) of local traffic and detects over 1500 applications on the network. AppRF allows you to configure both application and application category policies within a given user role.



The **Traffic Analysis** dashboard application visibility feature is supported only in 7000 Series, 7200 Series, and x86 managed devices, and requires WebCC and PEFNG license.

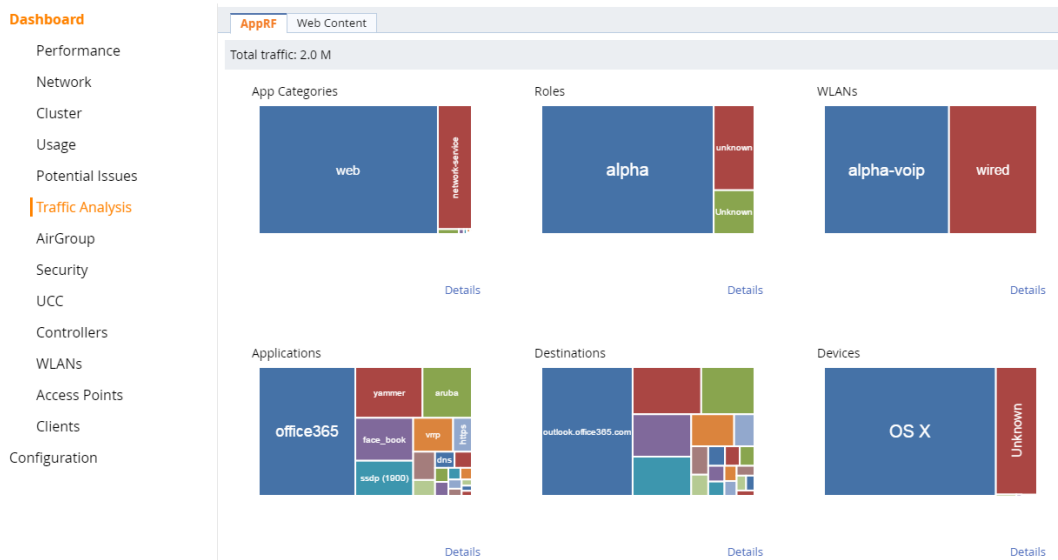
The **Traffic Analysis** dashboard contains the following tabs:

- **AppRF**—This tab displays the summary of all traffic in the managed device. This is the default page. For more information, see [AppRF on page 729](#).
- **Web Content**—This tab displays the summary of only the web traffic in the managed device. For more information, see [Web Content on page 732](#).



- **Blocked**—This tab displays WebCC and AppRF sessions which are blocked by ACL. For more information, see [Blocked on page 739](#). This tab is visible only when you login to the managed device.

**Figure 59** All Traffic and Web Content Tabs



## AppRF

Navigate to **Dashboard > Traffic Analysis** and click the **AppRF** tab. The **AppRF** page displays the PEF summary of all the sessions in the managed device aggregated by users, devices, destinations, applications, WLANs, and roles. The applications, application categories, and other containers are represented in box charts.

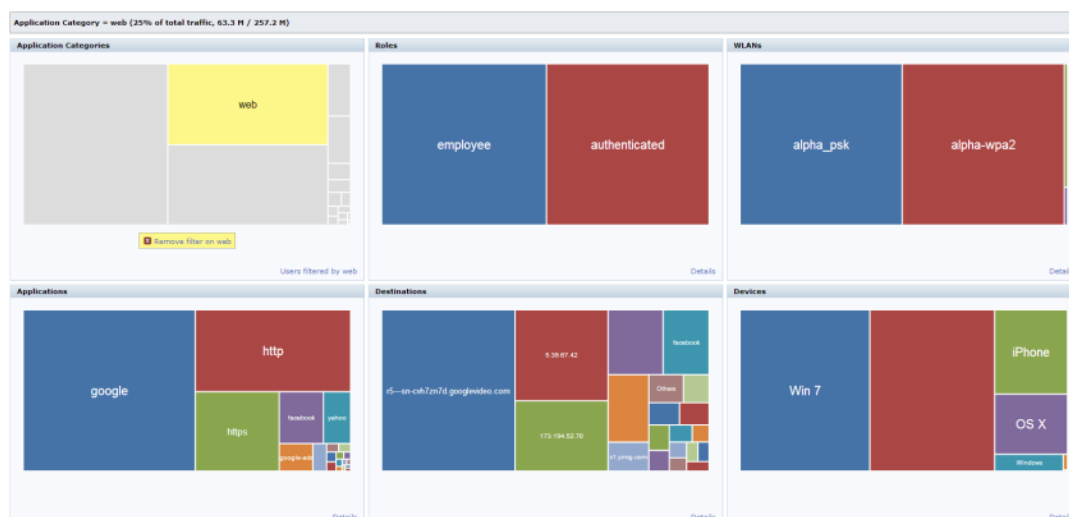
Enable DPI to enhance the benefit of the existing visualization or dashboard, To enable DPI, see the [Enabling Deep Packet Inspection](#) section.

## Filters

You can click on any rectangle tile in a container and that filter is applied across all the containers.

For example: If you click on the **Web** rectangle in the **App Categories** container, application category = web filter is applied to all other containers (Roles, WLANs, Application, Destination and Devices). See the following figure:

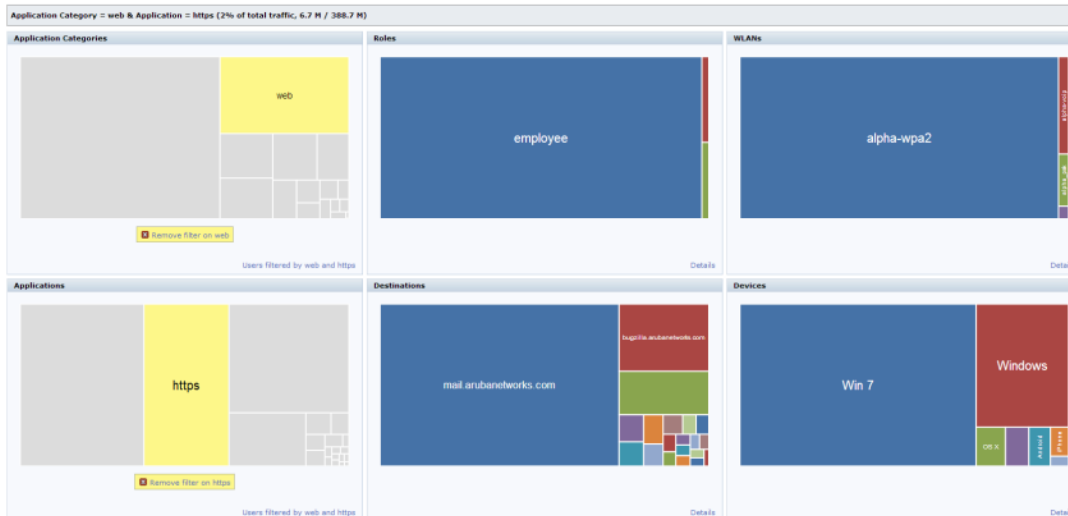
**Figure 60** Single Filter Applied



You can apply multiple filters from different containers by clicking on multiple rectangle tiles in various containers.

For example: If you click on the **Web** rectangle in the **App Categories** container and the **https** rectangle under **Application**, the remaining containers (Roles, WLANs, Destination and Devices) will be filtered on application category= web and application = https. See the following figure:

**Figure 61** Multiple Filters Applied



The action bar reflects the total traffic based on the filter applied. For example, see [Figure 62](#) and [Figure 63](#).

**Figure 62** Total traffic with Web Filter

**Application Category = web (26% of total traffic, 44.8 M / 174.6 M)**

**Figure 63** Total traffic with Web and https Filter

**Application Category = web & Application = https (5% of total traffic, 11.0 M / 205.7 M)**

To remove filters, click **Remove filter on <category>** in the container that filter is removed across all the containers.

## Details

Clicking the **Details** hyperlink, navigates you to the corresponding details page with data filtered by all selected rectangle when a filter is applied. The **Details** hyperlink changes to **User filtered by <filter>** in that container. See [Figure 64](#) and [Figure 65](#)



In the **WLANs** rectangle tile, **wired** indicates the traffic initiated by wired users and traffic from uplink ports.

Figure 64 Details

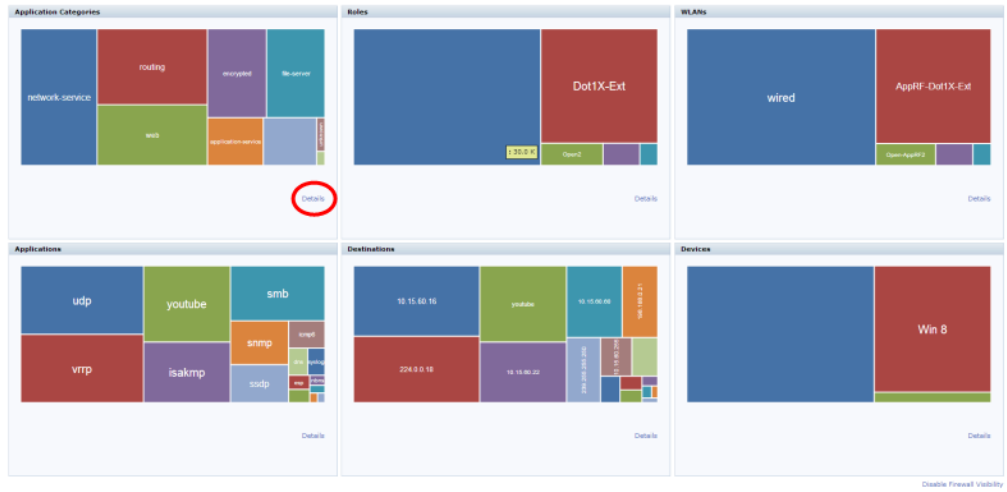
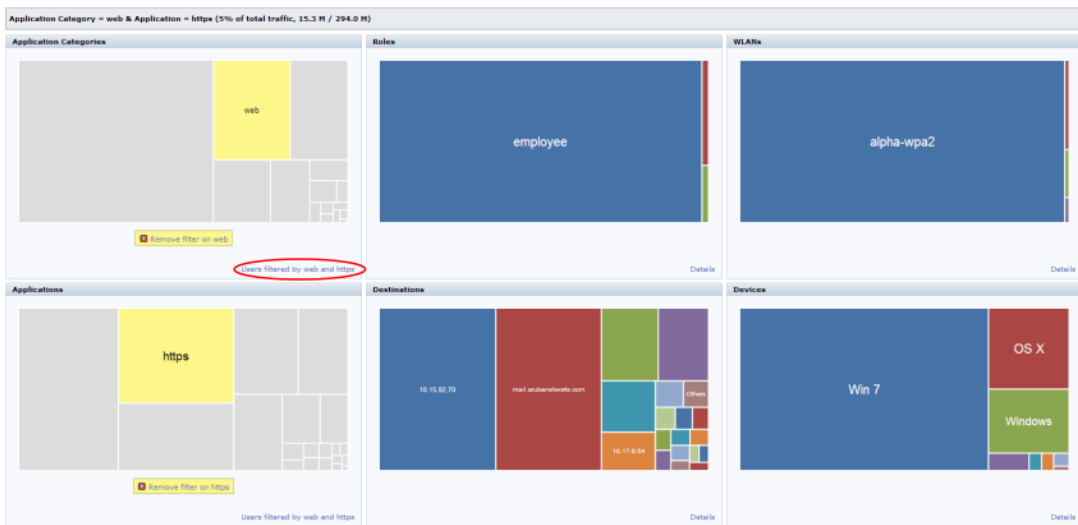
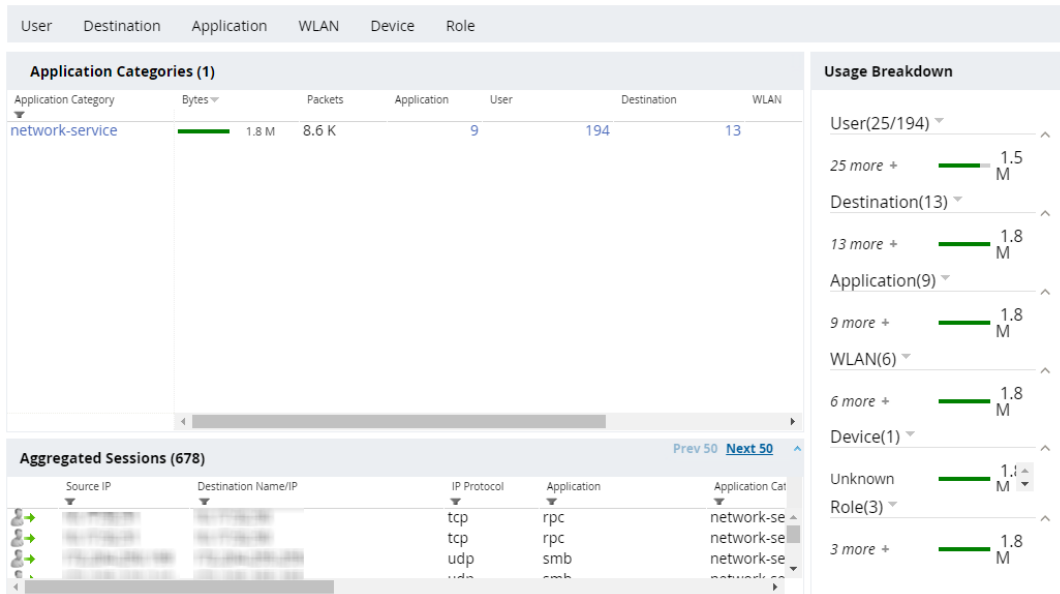


Figure 65 User filtered by <filter>

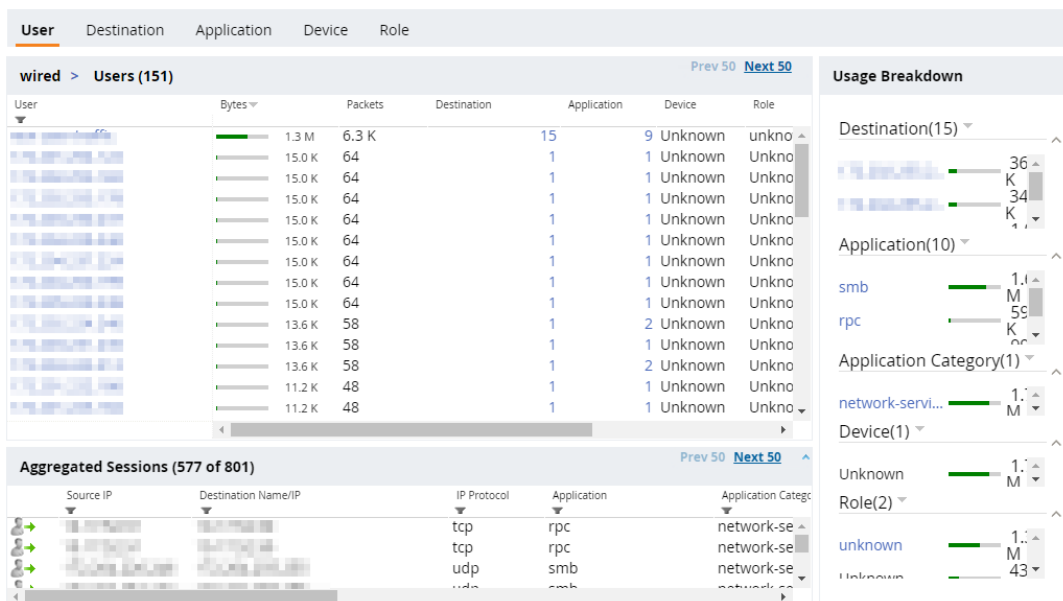


Clicking on **Details** or **User filtered by <filter>** hyperlink shows the user table, See [Figure 66](#) and [Figure 67](#).

**Figure 66** *Details View*



**Figure 67** *User filtered by <filter>- Details View*



## Web Content

The implementation of Web Content Classification (WebCC) feature can be viewed in this tab. WebCC uses a cloud-based service to dynamically determine the types of websites being visited, and their safety.



The WebCC feature requires the WebCC subscription license.

When the WebCC feature is enabled, all web traffic (http and https) is classified. The classification is done in data path as the traffic flows through the managed device and updates dynamically.

Aruba has partnered with Webroot®, a Web classification service to provide this WebCC feature in the Mobility Master. Aruba uses the Webroot's URL database and the cloud look-up service to classify the web traffic. Aruba uses Webroot classified categories and score for web categories and reputation for WebCC.

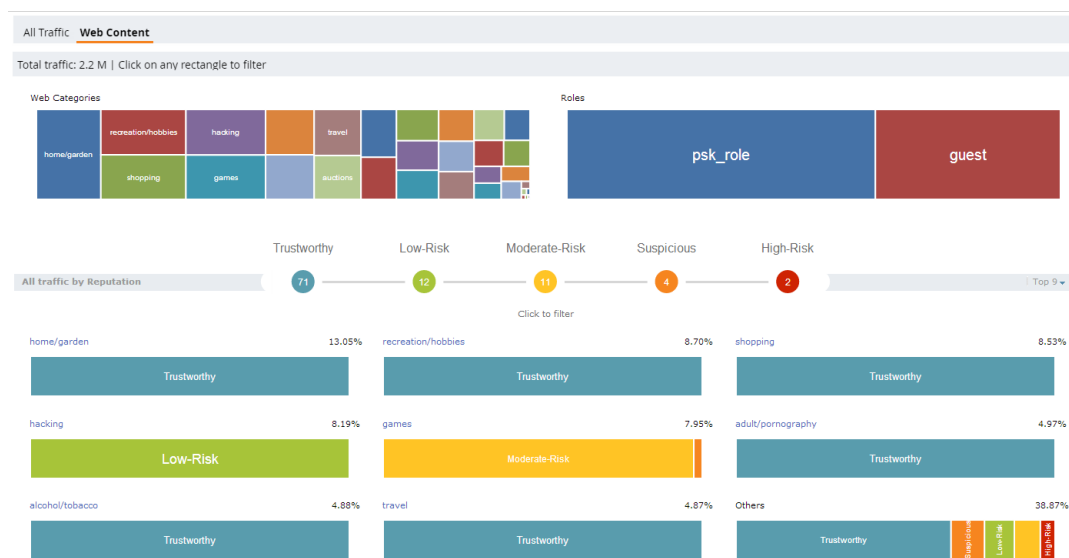
The current policy enforcement model in Aruba relies on L3/L4 information of the packet or L7 information with DPI support to apply rules. WebCC complements this as the user is allowed to apply firewall policies based on web content category and reputation.

Benefits of WebCC:

1. Prevention of malicious malware, spyware, or adware by blocking known dangerous websites
2. Visibility into web content category-level
3. Visibility into web sites accessed by the user

Navigate to **Dashboard > Traffic Analysis** . Click the **Web Content** tab. The following figure shows the **Web Content** page:

**Figure 68** Web Content Page



The web content page includes the following containers:

- **Web Categories:** This chart shows traffic for web categories in tree chart presentation. All boxes in this chart is click-able. Clicking on a box filters rest of page data with the clicked web category as filter, and this chart is locked until the filter is removed by clicking on **Remove filter on <web category>**. For example, see the following figure:

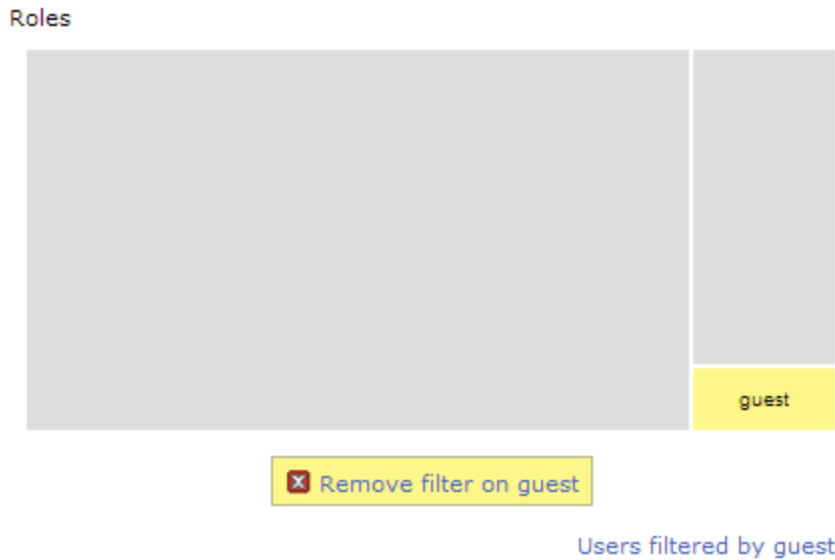
**Figure 69** Filter by Web Category



- **Roles:** This chart shows the traffic for user roles using the web traffic in tree chart presentation. All role boxes in this chart are click-able. Clicking on box filters rest of page data with the clicked Role as filter, and

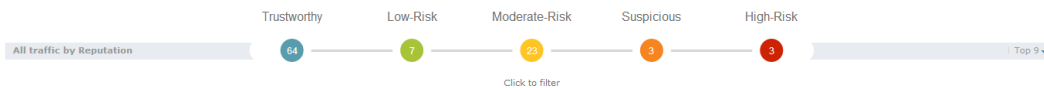
this chart is locked until the filter is removed by clicking on **Remove filter on <role name>**. For example, see the following figure:

**Figure 70 Filter by Role**



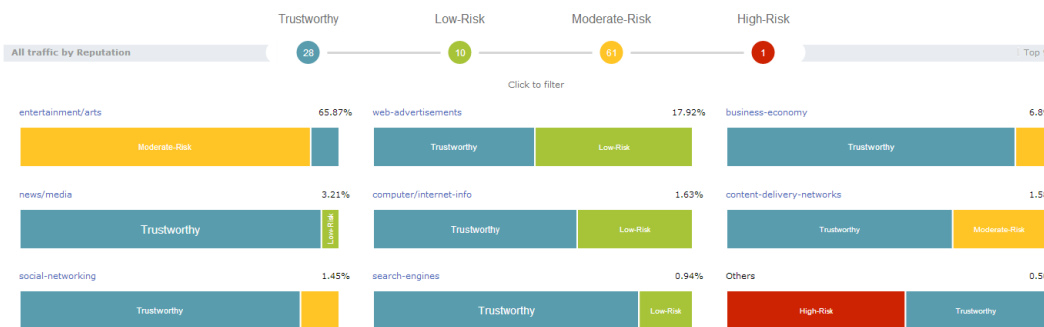
- All traffic by Reputation:** The reputation chart shows the percentage of traffic based on reputation or score of web traffic in the managed device. The reputation levels are Trustworthy, Low-Risk, Moderate-Risk, Suspicious, and High-Risk. If there is no traffic on a specific reputation, then the corresponding reputation does not appear in the chart. The circles in this chart are click-able. Clicking on a circle filters rest the of the page data with the selected reputation. This chart is locked until the filter is removed by clicking on **Remove filter on <reputation>**. For example, see the following figure:

**Figure 71 Filter by Reputation**



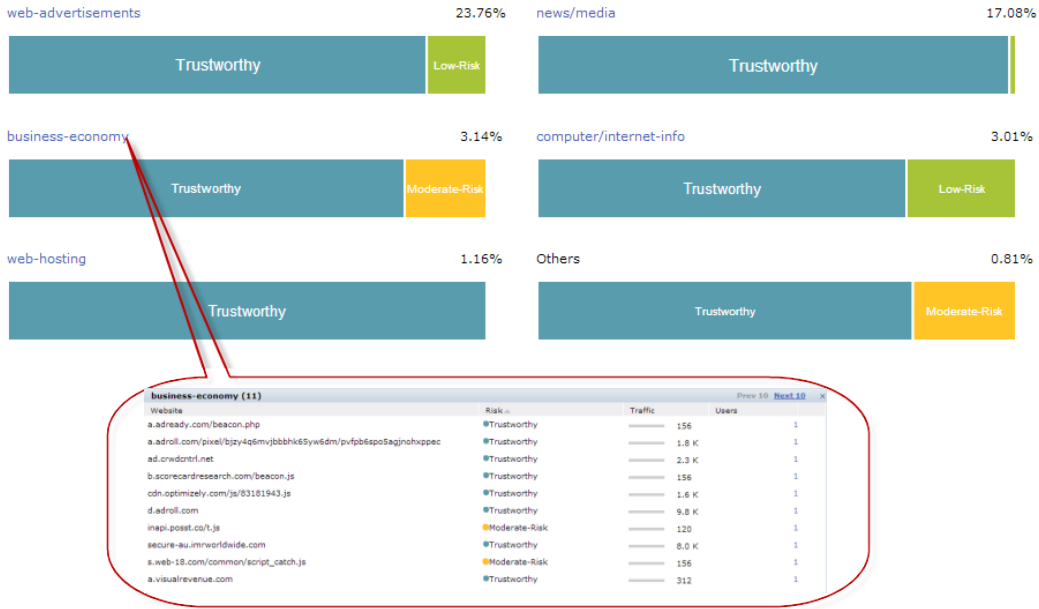
- Category Views:** A drop-down at the extreme right of reputation chart allows selecting the category view. The view options are **Top 9** and **Top 6**. **Top 9** is the default view and displays predefined set of categories that need to be listed in categories by reputation chart. This also list the top 6 or top 9 categories based on traffic usage. The list updates automatically when filters are applied. The following figure shows top 9 category view with reputation chart:

**Figure 72 Category View- Top 9**



- Details Table:** Click on the web category link above the Category view chart to display the details table as shown in the following figure.

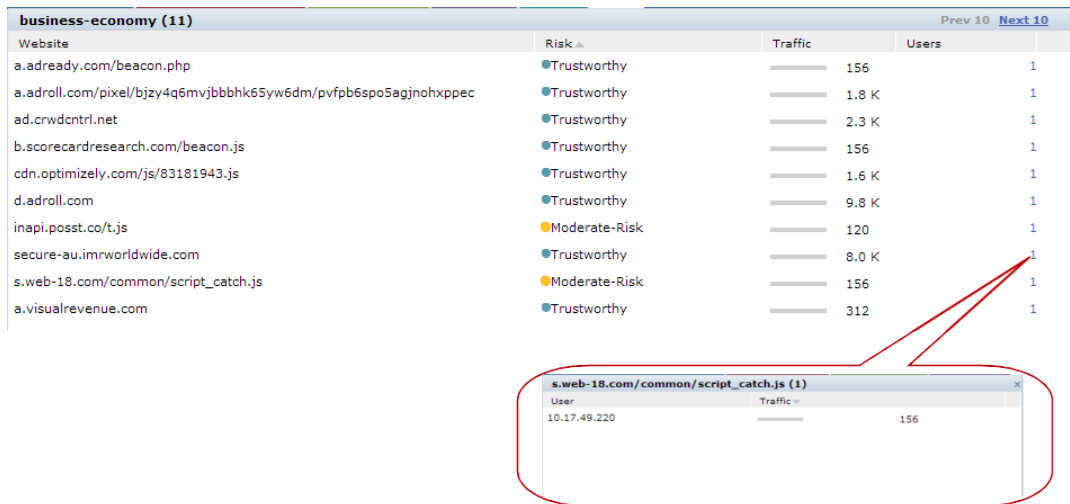
**Figure 73 Category Views and Details**



The details table of the selected web category includes the following four columns:

- **Website:** Lists the website.
  - **Risk:** Reputation score of the website with image presentation.
  - **Traffic:** Traffic of the website in total traffic of the selected category.
  - **User:** The number of users using that website.
- **User Table:** Click on the number in the **Users** column in the details table as shown in the following figure:

**Figure 74 User Table**



The user table includes the following columns:

- **User:** Lists the users of the website.
- **Traffic:** Traffic of the user on the website.

## Web Content Filters

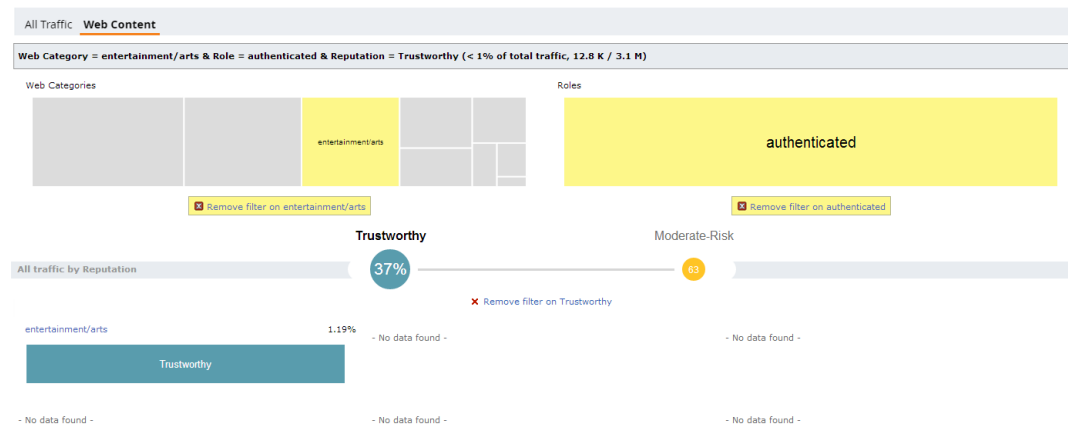
Web content filter behaves in the same way as described in [Filters on page 729](#). Filters can be applied to Web Categories, Roles, and Reputation containers.

Following are the properties of container filters:

- Clicking on any box in the tree chart or reputation chart will update whole page with the selected box as filter.
- On clicking, the tree chart will freeze that chart and update rest of the page.
- Filter will be applied only to non-freeze chart.
- Reputation chart color won't change upon selection.

The following figure shows an example with multiple filters:

**Figure 75** *Multiple Filters*



## WebCC Configuration in the WebUI

### Enabling WebCC

1. In the **Managed Network** node hierarchy or in the master controller mode, navigate to **Configuration > Roles & Policies > Policies** page.
2. From the **Enable web content classification** drop-down list, select **Enabled**

### New Policy Configuration

To configure a new policy and create an ACL rule with web category and reputation:

1. In the **Managed Network** node hierarchy or in the master controller mode, navigate to **Configuration > Services > Firewall > Global Settings**.
2. In the **Policies** table, click + to open **New Policy** window .
3. In the **Add Policy** window, enter a name for **Policy name**, and select **Session** from the **Policy type** drop-down list.
4. Select the newly added policy from the **Policies** table to display the **Policies > <policy name>** section below.
5. In the **Policies > <policy name>** table, click + to open a the **New rule for <policy name>** window.
6. For **Rule Type**, select **Application** and click **OK**.
7. In the **Roles > <policy name> > New application Rule** section:
  - a. From the **Scope** drop-down list, select **Web category/Reputation**.
  - b. From the **Web category** drop-down list, select the suitable web category.
  - c. From the **Web reputation** drop-down list, select the suitable reputation score.



- d. From the **Action** drop-down list, select **Deny** to not allow user to access this web category or **Permit** to allow user to access the web category.
  - e. For **TOS**, enter a value.
  - f. From the **Time range** drop-down list, select a suitable time range for which you want the the policy to be active or valid. Alternatively, you can also create a new time range but clicking + in this field
  - g. From the **802.1p priority** drop-down list, select a priority from 1 to 7.
  - h. For **Options**, select **Log**, **Mirror**, and **Blacklist**, or any of the options that is applicable.
8. Click **Submit**.
  9. Click **Pending Changes**.
  10. In the **Pending Changes** window, select the check box and click **Deploy changes**.

### WebCC Bandwidth Contract Configuration

1. In the **Managed Network** node hierarchy or in the master controller mode, navigate to **Configuration > Services > Firewall > White List BW Contracts**.
2. In the **BW Contract** table, click + to open the **New BW Contract** table.
3. For **White list contract name**, enter a name.
4. For **Bandwidth rate**, enter a value in pps.
5. Click **Submit**.
6. Click **Pending Changes**.
7. In the **Pending Changes** window, select the check box and click **Deploy changes**.

## WebCC Configuration in the CLI

### Enabling WebCC

```
(host) [mynode] (config) #firewall
(host) [mynode] (config-submode) #web-cc
```

Use the following command to configure WebCC per-role using the CLI:

```
(host) (mynode) (config-submode) #web-cc
```

### New Policy Configuration

The new CLI extends the existing policy configuration to take web category, reputation, or both. Use the following command to configure a new policy to create ACL rule with web category and reputation:

```
(host) (mynode) (config-submode) #source destination proto-port/service/app/app-group <name>
webcc-category <ctgry> webcc-reputation <score> action [log | mirror | time-range]
```

The following actions are supported when web category/reputation is selected:

- Deny
- Permit
- Blacklist
- Classify-media
- Disable-scanning
- Dot1q-priority
- Log
- Mirror
- Queue
- Time-range
- TOS

Example for WebCC policy configuration is as follows:

```
(host) [mynode] (config) #ip access-list session url-filter
(host) [mynode] (config-submode)#any any web-cc-category translation permit
(host) [mynode] (config-submode)#any any web-cc-reputation high-risk deny
(host) [mynode] (config-submode)#any any deny
```

Example for WebCC policy configuration only for **http** traffic running on TCP 80, the above ACL is modified as follows in datapath for pre-classification ACL scan:

```
(host) [mynode] (config) #ip access-list session url-filter
(host) [mynode] (config-submode)#any any tcp {80} permit
(host) [mynode] (config-submode)#any any tcp {80} deny
(host) [mynode] (config-submode)#any any deny
```

Post-classification, ACL look-up will have the ACL as follows:

```
(host) [mynode] (config) #ip access-list session url-filter
(host) [mynode] (config-submode)#any any tcp {80} WebCCtgID 40 WebCCRep 1-100 permit
(host) [mynode] (config-submode)#any any tcp {80} WebCCRep 1-100 deny
(host) [mynode] (config-submode)#any any deny
```

In case there exists an ACL rule to deny/permit a specific web category but is required to make an exception to allow/deny a specific URL or website, then this can be accomplished by configuring in the following manner:

1. First define a netdestination with one or more URLs to whitelist or blacklist

```
(host) [mynode] (config) #netdestination search
(host) [mynode] (config-submode) #name www.google.com
(host) [mynode] (config-submode) #name www.bing.com
(host) [mynode] (config-submode) #exit
```

2. Apply this netdestination to an ACL

```
(host) [mynode] (config) #ip access-list session whitelist
(host) [mynode] (config-submode)#any alias search tcp 80 permit
(host) [mynode] (config-submode)#any alias search tcp 443 permit
```

3. Apply this ACL to a user-role. The position of this ACL should be at the top. However, with global or role-specific default ACLs this wouldn't be possible.

```
(host) [mynode] (config) #user-role guest2
(host) [mynode] (config-submode) #access-list session whitelist
```



---

If there a WebCC or app rule that is applicable globally across user-roles then you cannot override such behavior. This is a limitation.

---

## WebCC Bandwidth Contract Configuration

With this feature, ArubaOS supports configuring WebCC category and reputation based bandwidth contract configuration/enforcement. This can be enforced globally for all user-roles, or can be enforced per user-role.

Use the following command to apply global WebCC based bandwidth contracts using the CLI:

```
(host) (mynode) (config) #web-cc global-bandwidth-contract {webcc-category|webcc-reputation}
{upstream|downstream}{kbits <value>|mbits <value>}
```

Use the following command to apply AAA bandwidth contracts using the CLI:

```
(host) (mynode) (config) #aaa bandwidth-contract webcc mbits <value>
```

Use the following command to apply role-specific web-cc based bandwidth contracts using the CLI:

```
(host) (mynode) (config) #user-role webcc
(host) (mynode) (config-role) #bw-contract {webcc-category|webcc-reputation}<name> <contract>
{upstream|downstream}{kbits <value>|mbits <value>}
```

## Debugging

The following **show** commands are introduced as part of this feature:

- **show web-cc category all:** Displays all WebCC categories
- **show web-cc reputation:** Displays WebCC reputation
- **show web-cc stats:** Displays the statistics of WebCC module in CP
- **show web-cc status:** Display the status of Web-CC module in CP
- **show web-cc global-bandwidth-contract:** Displays configured WebCC bandwidth contract
- **show datapath web-cc:** Displays md5, web category, reputation, and age for each URL
- **show datapath web-cc counters:** Displays the number of URLs in cache, Classified and Unclassified sessions.
- **show datapath session web-cc:** Displays Internal Flags, Pre Classification ACE Index, and Post Classification ACE Index
- **show gsm debug channel web\_cc\_info:** Lists md5, Category, and Reputation for each URL. GSM entries are populated as and when URL cache entry is learned, and it is used for reporting the actual URLs being associated with user session entries.

The following **clear** command are introduced as part of this feature:

- **clear web-cc cache <md5\_1> <md5\_2> :** Clears the WebCC cache entry from both data plane and GSM.
- **clear web-cc stats:** Clears all WebCC statistics.
- **clear datapath web-cc counters:** Clears configuration values and statistics in the WebCC datapath module.

## Blocked

The system administrator can to look at blocked sessions for AppRF and WebCC when logged in to the managed device. System administrators can see blocked sessions belonging to a specific web-category (like news / sports / gambling), session belonging to specific app category, as shown in the following figure.

**Figure 76** *Blocked Tab*

Sessions (9)			All Application Rules Web Content Rules			
Client	Event Name	Web Content URL Prefix	Role	WLAN	AP Name	BSSID
192.168.1.101	app-content denied	Unknown	psk-role	192.168.1.101	192.168.1.101	192.168.1.101
192.168.1.102	web-content denied	miniclip.com	psk-role	192.168.1.102	192.168.1.102	192.168.1.102
192.168.1.103	app-content denied	Unknown	psk-role	192.168.1.103	192.168.1.103	192.168.1.103
192.168.1.104	web-content denied	games.yahoo.com	psk-role	192.168.1.104	192.168.1.104	192.168.1.104
192.168.1.105	web-content denied	pogo.com	psk-role	192.168.1.105	192.168.1.105	192.168.1.105
192.168.1.106	web-content denied	iplay.com	psk-role	192.168.1.106	192.168.1.106	192.168.1.106
192.168.1.107	app-content denied	Unknown	psk-role	192.168.1.107	192.168.1.107	192.168.1.107
192.168.1.108	web-content denied	y8.com	psk-role	192.168.1.108	192.168.1.108	192.168.1.108
192.168.1.109	web-content denied	gamehouse.com	psk-role	192.168.1.109	192.168.1.109	192.168.1.109

This tab displays WebCC and AppRF sessions which are blocked by ACL.

The Blocked session feature is enabled by default. Once the management server is configured, AMON feed generation is enabled by default. Only for system logging , enable firewall visibility **blk-session** option CLI command.

Log in to the managed device, navigate to **Dashboard > Traffic Analysis > Blocked** to view blocked sessions. You can view this page for the following information:

- **Blocked by Web Category:** Blocked session data is seen in the managed device for WebCC ACLs. You can filter by clicking on any box in this container tree chart and the information in other containers update accordingly.
- **Blocked by App Category:** Blocked session data is seen in the managed device for AppRF ACLs. You can filter by clicking on any box in this container tree chart and the information in other containers update accordingly.
- **Blocked by Role:** Blocked session data is seen in the managed device for role ACLs. You can filter by clicking on any box in this container tree chart and the information in other containers update accordingly.

You can view the list of all blocked web category and app category in table format in the **Sessions** section. This section has the following three views:

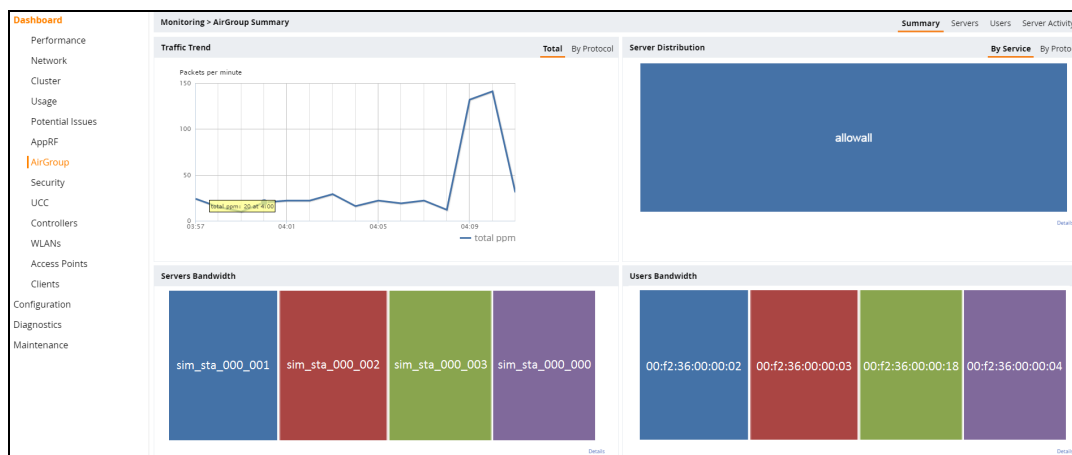
- **All**—Displays all the blocked sessions.
- **Application Rules**—Displays sessions that are blocked by application rules.
- **Web Content Rules**—Displays sessions that are blocked by web content rules.

This table also has column filters and column sorting.

## AirGroup

The **Dashboard > AirGroup** dashboard provides enhanced visibility into AirGroup, which is a unique enterprise-class solution that leverages zero configuration networking to enable Bonjour® services like Apple® AirPrint and AirPlay from mobile devices in an efficient manner. AirGroup supports both wired and wireless devices and Aruba ClearPass Policy Manager. The combined view of all AirGroup devices and usage in the network is available under the **AirGroup** dashboard of every node in the hierarchy, regardless of deployment type.

**Figure 77** *AirGroup Dashboard*



## AirGroup Summary

The **Monitoring > AirGroup Summary** page provides visual overviews on the AirGroup traffic trends, server distribution, server bandwidth, and user bandwidth.

### Traffic Trend

AirGroup devices generate query and response packets to discover and publish services. The **Traffic Trend** graph allows users to monitor packet rate by displaying the number of packets transmitted and received by AirGroup per minute, over the last 15 minutes. The toggle buttons at the top of the graph allow you to switch between **Total** number of packets per minute and number of packets per minute **By Protocol**.

- The **Total** graph displays the total number of packets transmitted and received by AirGroup per minute.
- The **By Protocol** graph displays the number of packets transmitted and received based on the protocol type; mDNS or DLNA. This graph also indicates which protocol is generating more traffic.

## Server Distribution

The **Server Distribution** box chart represents the distribution of protocols and the top 20 services across all AirGroup servers. The toggle buttons at the top of the graph allow you to switch views between distribution **By Service** and distribution **By Protocol**.

- **By Service** represents the distribution of the top 20 services across all AirGroup servers. Services are labeled using the respective service IDs.
- **By Protocol** represents the distribution of protocols, such as mDNS and DLNA, across all AirGroup servers.

By clicking a specific box from the **Server Distribution** chart, you can navigate to the **Monitoring > AirGroup** page in which the servers are organized by service/protocol type and server count.

## Servers Bandwidth

AirGroup servers and users generate control traffic and data traffic, based on total bytes transmitted and received. Control traffic is generated from the query and response packets that discover and publish services. When the user discovers and attempts to use a service, data traffic, which comprises of User Datagram Protocol (UDP) and Transmission Control Protocol (TCP) sessions, is established between the server and user.

The **Servers Bandwidth** box chart represents usage of the top 20 servers based on bandwidth or data traffic within the last 2 minutes. Devices are marked as 'server' when the device's mDNS response is cached by AirGroup. This information can be used to determine which server's aggregated active sessions have consumed the most data. Click a server to navigate to the **Server Activity** tab, where you can view more information on the aggregated data sessions between the selected server and its users.

## Users Bandwidth

The **Users Bandwidth** box chart represents the top 20 users based on bandwidth, or data traffic, within the last 2 minutes. Devices are marked as 'user' when the device receives a response for an mDNS query from AirGroup. This information can be used to determine which user's aggregated active sessions have consumed the most data. Click a user to navigate to the **Server Activity** tab, where you can view more information on the aggregated data sessions between the servers and the selected user.



---

The user bandwidth shown is only for the last 2 minutes of bandwidth consumption.

---

## AirGroup Servers

The **Monitoring > AirGroup Servers** page provides more in-depth information on each AirGroup server.

**Figure 78** AirGroup Servers Page

The screenshot shows the 'Monitoring > AirGroup Servers' page. It has tabs for 'Summary', 'Servers', 'Users', and 'Server Activity'. The 'Servers' tab is active, displaying two tables.

**Servers (9)**

Station MAC	Service	Server Host Name	IP Address	Role	Wired/Wireless	AP Name	VLAN ID	Group(s)	AirGroup Type
d8:5d:e2:5b:fb:ea	allowall	DEVCC61AB	fe80:da5d:e2ff:fe5b:fb:ea	authenticated	wireless	SH-3F...5-Manoj	102	Unknown	mDNS
5c:c5:d4:db:dd:96	allowall	5c:c5:d4:db:dd:96	10.20.104.89	alpha	wireless	SH-3F-225-TempleR...	104	Unknown	DLNA
68:d9:3c:7a:ba:48	allowall	chandrayaan-appletv	fe80:82a:59ad:6064:f55	authenticated	wireless	SH-3F-24-AP225	102	Unknown	mDNS
98:d6:bb:28:37:c6	allowall	kanchenjuga-14	fe80:1c78:4909:2ed:d3db3	authenticated	wireless	SH-1F-KUNCHENJU...	102	Unknown	mDNS
b8:78:2e:4c:0b:77	allowall	Aryabhata-6	fe80:110f4:7a2f:9b98:3309	authenticated	wireless	SH-3F-Aryabhata	102	Unknown	mDNS
00:0c:29:92:52:b4	allowall	wautorun-virtual-machine	10.20.101.34	Unknown	--	Unknown	101	Unknown	mDNS
00:25:90:9e:40:42	allowall	00:25:90:9e:40:42	10.20.103.234	Unknown	--	Unknown	103	Unknown	DLNA
00:24:d7:40:b0:c4	allowall	TEST-PC	fe80:3103:889e:2852:2113	alpha	wireless	SH-1F-13	104	Unknown	DLNA
60:f1:89:61:40:7a	allowall	60:f1:89:61:40:7a	10.20.104.74	alpha	wireless	SH-3F-023-RaviKum...	104	Unknown	mDNS

**Servers Usage (9)**

Station MAC	Server Host Name	Bandwidth	mDNS ppm	DLNA ppm	Total PPM...
d8:5d:e2:5b:fb:ea	DEVCC61AB	0	--	--	--
5c:c5:d4:db:dd:96	5c:c5:d4:db:dd:96	0	--	--	--
68:d9:3c:7a:ba:48	chandrayaan-appletv	0	4	0	4
98:d6:bb:28:37:c6	kanchenjuga-14	0	--	--	--
b8:78:2e:4c:0b:77	Aryabhata-6	0	--	--	--
00:0c:29:92:52:b4	wautorun-virtual-machine	0	1	0	1
00:25:90:9e:40:42	00:25:90:9e:40:42	0	0	4	4
00:24:d7:40:b0:c4	TEST-PC	0	--	--	--
60:f1:89:61:40:7a	60:f1:89:61:40:7a	0	--	--	--

The **AirGroup Servers** table includes the following parameters:

**Table 154:** AirGroup Servers Parameters

Parameter	Description
Station MAC	MAC address of the AirGroup server.
Service	Service used by the AirGroup server (for example, AirPrint or AirPlay).
Server Host Name	Host name of the AirGroup server.
IP Address	IP address of the AirGroup server.
Role	Role assigned to the AirGroup server (for example, guest).
Wired/Wireless	Connection type.
AP Name	Name of the AP to which the wireless server is associated.
VLAN ID	ID of the VLAN to which the server is associated.
Group(s)	Server group.
AirGroup Type	Protocol type (mDNS or DLNA).

The **Servers Usage** table provides the control and data traffic trends for each server. Control traffic appears upon clicking any PPM data field for a server. Data traffic displays the total bandwidth consumed by active sessions between the server and user.

The **Servers Usage** table includes the following parameters:

**Table 155: Servers Usage Parameters**

Parameter	Description
Station MAC	MAC address of the AirGroup server.
Server Host Name	Host name of the AirGroup server.
Bandwidth	Total active bandwidth between the server and one or more users per minute. This field displays bandwidth from up to the last 15 minutes.
mDNS PPM	The current amount of mDNS control traffic generated per minute. By clicking this field, you can view mDNS PPM data from the last 15 minutes.
DLNA PPM	The current amount of DLNA control traffic generated per minute. By clicking this field, you can view DLNA PPM data from the last 15 minutes.
Total PPM	The sum of mDNS and DLNA control traffic generated per minute. By clicking this field, you can view the combined data from the last 15 minutes.

## AirGroup Users

The **Monitoring > AirGroup Users** page provides more in-depth information on each AirGroup user.

**Figure 79** AirGroup Users Page

The screenshot shows the 'Monitoring > AirGroup Users' page with two main sections: 'Users (7)' and 'Users Usage (11)'. The 'Users (7)' table lists user details, and the 'Users Usage (11)' table shows usage statistics for each user.

Monitoring > AirGroup Users									
Users (7)									
Station MAC	Client User Name	IP Address	Host Name	Role	AP Name	VLAN ID	Group(s)	AirGroup Type	Wired/Wireless
ac:81:12:59:5c:07	ac:81:12:59:5c:07	10.20.102.38	Unknown	authenticated	SH-3F-010-BREAKA...	102	Unknown	DLNA	wireless
28:e3:1f:7a:46:aa	nmurthy	10.20.103.53	Unknown	alpha	SH-1F-PANTRY	103	Unknown	mDNS	wireless
3ca9:f4:7f:85:f4	sprakash	10.20.104.87	Unknown	alpha	SH-3F-26-AP115	104	Unknown	DLNA	wireless
58:94:6b:31:ca:f8	venky	10.20.102.236	Unknown	alpha	SH-3F-...-Anurag	102	Unknown	DLNA	wireless
00:0b:86:85:2d:c0	00:0b:86:85:2d:c0	10.20.105.15	Unknown	Unknown	Unknown	104	Unknown	DLNA	--
00:24:d7:40:b0:c4	mbabu	fe80::3103:889e...	TEST-PC	alpha	SH-1F-13	104	Unknown	mDNS	wireless
cc:3a:f1:94:92:8c	nsoragavi	fe80::ce3a:61ff:fe...	Unknown	alpha	SH-1F-20	104	Unknown	DLNA	wireless

Users Usage (11)					
Station MAC	Client User Name	Bandwidth	mDNS ppm	DLNA ppm	Total PPM
ac:81:12:59:5c:07	ac:81:12:59:5c:07	0	--	--	--
28:e3:1f:7a:46:aa	nmurthy	0	--	--	--
3ca9:f4:7f:85:f4	sprakash	0	--	--	--
58:94:6b:31:ca:f8	venky	0	--	--	--
68:d9:3c:7a:ba:48	68:d9:3c:7a:ba:48	0	--	--	--
98:d6:bb:28:37:c6	98:d6:bb:28:37:c6	0	--	--	--
b8:78:2e:4c:0b:77	b8:78:2e:4c:0b:77	0	--	--	--
00:0b:86:85:2d:c0	00:0b:86:85:2d:c0	0	--	--	--
00:0c:29:92:52:b4	00:0c:29:92:52:b4	0	--	--	--
00:24:d7:40:b0:c4	mbabu	0	--	--	--
cc:3a:f1:94:92:8c	nsoragavi	0	--	--	--

The **AirGroup Users** table includes the following parameters:

**Table 156: AirGroup Users Parameters**

Parameter	Description
Station MAC	MAC address of the AirGroup user.
Client User Name	Name of the AirGroup user.
IP Address	IP Address of the AirGroup user.
Host Name	Host name of the AirGroup user.
Role	User role (employee or guest).
AP Name	Name of the AP to which the user is associated.
VLAN ID	ID of the VLAN to which the user is associated.
Group(s)	Group to which the user belongs.
AirGroup Type	Type of AirGroup protocol assigned to the user (mDNS or DLNA).
Wired/Wireless	Connection type.

The **Users Usage** table provides the control and data traffic trends for each user. Control traffic appears upon clicking any PPM data field for a user. Data traffic displays the total bandwidth consumed by the user, and the total number of servers accessed by the user.

The **Users Usage** table includes the following parameters:

**Table 157: Users Usage Parameters**

Parameter	Description
Station MAC	MAC address of the AirGroup server.
Client User Name	Username of the client.
Bandwidth	Total active bandwidth between the server and one or more users within the last 15 minutes.
mDNS PPM	The current amount of mDNS control traffic generated per minute. By clicking this field, you can view mDNS PPM data from the last 15 minutes.
DLNA PPM	The current amount of DLNA control traffic generated per minute. By clicking this field, you can view DLNA PPM data from the last 15 minutes.
Total PPM	The sum of mDNS and DLNA control traffic generated per minute. By clicking this field, you can view the combined data from the last 15 minutes.



## AirGroup Server Activity

The **Monitoring > AirGroup Server Activity** page contains a list of server and user traffic data from active sessions, and includes the following parameters:

**Table 158:** *Server Activity Parameters*

Parameter	Description
Session Id	ID to identify the AirGroup session.
Server Host Name	Host name of the AirGroup server.
Client User Name	Username of the client.
Bandwidth	Total bandwidth between the server and user within the last 15 minutes.
Source IP	IP address of the AirGroup server.
Destination IP	IP address of the AirGroup user.

For more information on the AirGroup feature, see [AirGroup on page 939](#)

## Security

The **Security** page allows you to monitor the detection and protection of wireless intrusions in your network.

The two top tables—**Discovered APs & Clients** and **Events**—contain data as links. When these links are selected, they arrange, filter, and display the appropriate information in the lower table, **Discovered Access Points**.



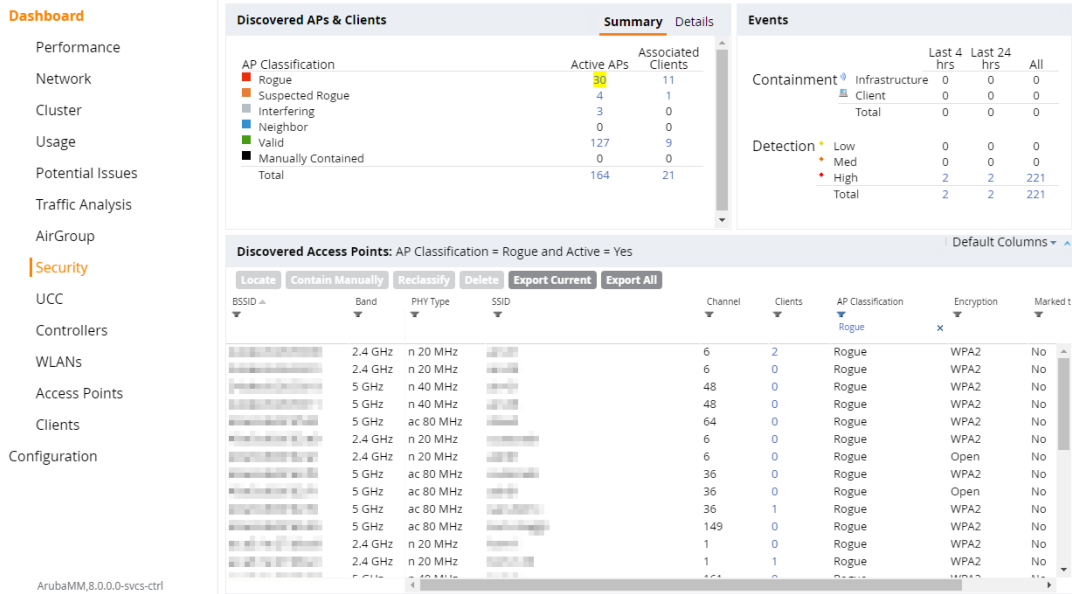
---

The term **events** in this document refers to security threats, vulnerabilities, attacks (intrusion or Denial of Service), and other related events.

---

The following figure shows the **Security** page:

**Figure 80 Security Page**



## UCC

The Unified Communication and Collaboration (UCC) Dashboard Aggregated Display shows an aggregated view of the UCC calls made in the managed devices. The administrator can see a top level view of the call quality assessment, and further drill down into a specific view based on the analysis required.



The UCC feature requires the PEFNG license.

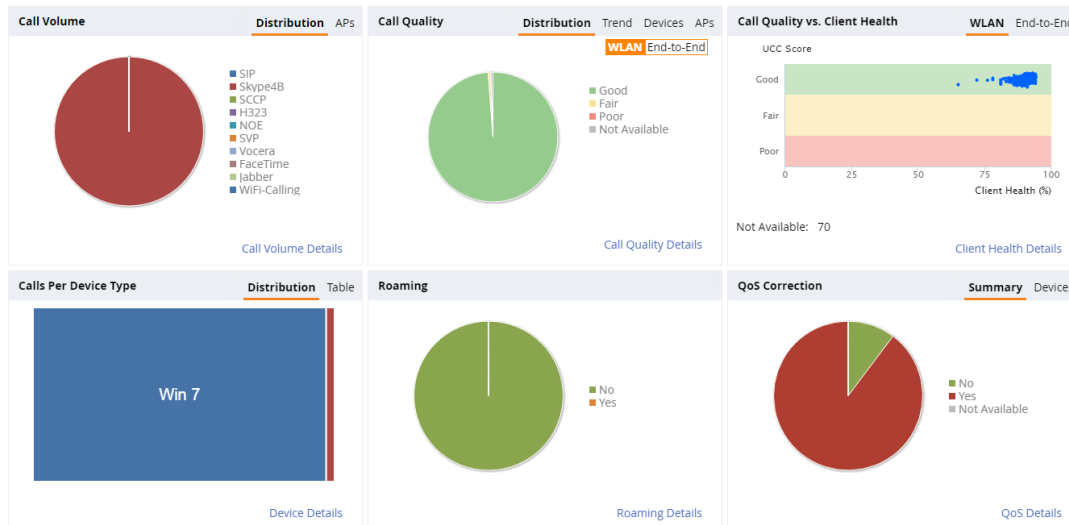
Call Quality is encapsulated into an Aruba-proprietary metric called UCC Score. The UCC Score for voice and video calls is measured by taking into account the following metrics:

- Delay
- Jitter
- Packet Loss

## Chart View

A new **UCC** tab is introduced under the **Dashboard** tab. Navigate to the **Dashboard > UCC** page to view UCC dashboard. Clicking the **UCC** hyperlink displays the following characteristics (in graphical format) of the UCC deployment.

**Figure 81 UCC Dashboard**



- **Call Volume** – This graph displays the total number of calls made based on the UCC application type. For example, SIP, Skype4B, SCCP, H.323, NOE, SVP, Vocera, FaceTime, Jabber, and WiFi-Calling. On clicking the **APs** tab, the graph displays the total number of calls per AP.
  - **Call Quality** – This graph displays the AP-to-Client call quality under the **WLAN** tab and the end-to-end quality including wired and wireless legs of the call under the **End-to-End** tab. The number of UCC calls are categorized by the following call quality:
    - **Good**
    - **Fair**
    - **Poor**
    - **Not Available** – In the **WLAN** tab, short duration voice calls (less than 60 seconds), video calls, and file-transfer session are categorized as **Not Available**. In the **End-to-End** tab, short duration voice calls (less than 60 seconds), video calls, file-transfer, and app-sharing sessions are categorized as **Not Available**.
- The **Trend** tab displays the call quality over a period of time. The **Devices** tab categorizes the call quality based on the type of device. The **APs** tab displays the percentage of poor call quality per AP.
- **Call Quality vs. Client Health** – This graph displays the correlation between the VoIP call quality and the VoIP client health of every UCC call. This graph displays the UCC score under the **WLAN** tab and MOS under the **End-to-End** tab.



When VoIP calls are prioritized using media classification like Lync/Skype for Business, Apple Facetime and Wi-Fi Calling, the **End-to-End** call quality is not available. In addition, WLAN-based quality metrics including **Call Quality vs. Client Health** scatter plot are not available.

- **Calls Per Device Type** – This graph displays the calls made per device type. For example, Windows 7, Mac OS X, iPhone, or Android. On clicking the **Table** tab, Mobility Master lists the calls per device type in a tabular format. Any call that was made 6+ hours before is not listed here.
- **Roaming** – Roaming status of UCC clients. The status can be:
  - **No** – Number of calls where the client did not roam to a new AP during an active call.
  - **Yes** – Number of calls where the client has roamed to a new AP during an active call.
- **QoS Correction** – If the DSCP value of the Real-time Transport Protocol (RTP) packets sent by the client differs from corresponding priority value configured for the application, Mobility Master corrects this value as per the SSID profile definition and classifies the call as QoS corrected. This graph displays the number of

UCC calls where Mobility Master has corrected the WMM-DSCP value for such calls. The QoS correction is categorized as:

- **No** – No WMM-DSCP value correction.
- **Yes** – WMM-DSCP value corrected by Mobility Master.
- **Not Available** – WLAN short duration calls (less than 60 seconds) is categorized as **Not Available**.

The **Devices** tab displays the QoS corrections based on the type of device.

## Details View

Navigate to the **Dashboard > UCC** page. To display an aggregated list of all the UCC call data metrics in Mobility Master, click any of the following hyperlinks:

- Call Volume Details
- Call Quality Details
- Client Health Details
- Device Details
- Roaming Details
- QoS Details

[Figure 82](#) displays an aggregated list of all the UCC call data metrics in Mobility Master.

**Figure 82** *Wireless Call List*

Wireless Call List (13702)											
CDR ID	UCC Call ID	IP Address	Station MAC	Client	UCC Client Id	Destination IP	Called Party	ALG	AP Name	Health(%)	
5,662	2,823	192.168.201.240	f0:7b:cb:3b:65:5c	uccsol2	uccsol2	192.168.201.246	uccsol3	Skype4B	UCC-AP115-1	100	
5,674	2,829	192.168.201.240	f0:7b:cb:3b:65:5c	uccsol2	uccsol2	192.168.201.246	uccsol3	Skype4B	UCC-AP115-1	100	
5,686	2,835	192.168.201.240	f0:7b:cb:3b:65:5c	uccsol2	uccsol2	192.168.201.246	uccsol3	Skype4B	UCC-AP115-1	100	
5,698	2,841	192.168.201.240	f0:7b:cb:3b:65:5c	uccsol2	uccsol2	192.168.201.246	uccsol3	Skype4B	UCC-AP115-1	100	

Wireless Call List (13704)												
CDR ID	UCC Score [A] ...	UCC Band [A]	WLAN			CONTROLLER						
			Delay (msec)	Jitter (msec)	Packet Loss(%)	UCC Score [C] ...	UCC Band [C]	Delay (msec)	Jitter (msec)	Packet Loss(%)	MOS	MOS Band
5,662	85.97	Good	0.33	0	0.11	89.13	Good	0.09	3.97	0.34	4.23	Good
5,674	84.22	Good	0.31	0	0	85.93	Good	0.08	8.1	0.69	4.25	Good
5,686	84.49	Good	0.39	0	0	91.42	Good	0.1	0.3	0	4.26	Good
5,698	85.16	Good	0.34	0.01	0.06	92.04	Good	0.08	0.3	0	4.27	Good

Wireless Call List (13706)												
CDR ID	End-to-End		Packet Loss(%)	Client WMM AC	Modified WMM AC	Client DSCP	Modified DSCP	Direction	Duration (sec)	Start Time		State
	Delay (msec)	Jitter (msec)								Jun 25, 2016	Jun 25, 2016	
5,662	6	2	0.07	5	6	40	46	OG	116	05:33:43	Jun 25, 2016	Success
5,674	6	1	0.03	0	6	24	46	OG	116	05:36:21	Jun 25, 2016	Success
5,686	5	3	0.07	5	6	40	46	OG	117	05:38:58	Jun 25, 2016	Success
5,698	7	3	0.03	5	6	40	46	OG	117	05:41:36	Jun 25, 2016	Success

Wireless Call List (13710)											
CDR ID	ie	Termination Reason	Application	Codec	ICH Status	Device	In Call Roam	QoS Correction	Connection Type	BSSID	Controller IP
5,662	:cess	Terminated	Voice	G722	Permit	Win 7	No	Yes	Wireless	aca3:1e:27:e4:b1	192.168.200.14
5,674	:cess	Terminated	Voice	G722	Permit	Win 7	No	Yes	Wireless	aca3:1e:27:e4:b1	192.168.200.14
5,686	:cess	Terminated	Voice	G722	Permit	Win 7	No	Yes	Wireless	aca3:1e:27:e4:b1	192.168.200.14
5,698	:cess	Terminated	Voice	G722	Permit	Win 7	No	Yes	Wireless	aca3:1e:27:e4:b1	192.168.200.14

VoIP calls made to/from clients outside the managed device are displayed in the **External Call List** pane. This pane lists all the external and wired client call CDRs. See [Figure 83](#).



External call list is available only when Lync/Skype for Business SDN API is configured on Mobility Master.

**Figure 83 External Call List**

External Call List (3 of 15376)												
CDR ID	UCC Call ID	IP Address	UCC Client Id	Destination IP	Called Party	Direction	ALG	State	Termination Reason	Application	MOS	MOS Band
15,352	7,666	10.16.126.16	uccsol6	192.168.201.249	uccsol7	IC	Skype4B	Success	Terminated	Voice	4.17	Good
15,360	7,670	10.16.126.16	uccsol6	192.168.201.249	uccsol7	OG	Skype4B	Success	Terminated	Voice	4.17	Good

External Call List (3 of 15378)												
CDR ID	End-to-End			Duration (sec)	Start Time	Codec	Connection Type	Client DSCP	Modified DSCP	Device	QoS Correction	
	Delay (msec)	Jitter (msec)	Packet Loss(%)									
15,352	3	3	--	133	08:36:41 Jun 27, 2016	G722	External	--	--	Unknown	Not Available	
15,360	3	4	--	114	08:39:10 Jun 27, 2016	G722	External	--	--	Unknown	Not Available	

## Controller

The **Controller** page lists all the managed devices in the network and provides its health related information as shown in the following figure:

**Figure 84 Controller Page**

**Dashboard**

- Performance
- Network
- Usage
- Potential Issues
- Traffic Analysis
- AirGroup
- UCC
- Controllers**
- WLANS
- Access Points
- Clients
- Configuration

Controllers (4)										Custom Columns
Name	Reachability	Health	APs	Clients	Uptime	Configuration State	Model	Software		
MN-7240	<span style="color: green;">●</span>	Good	0	78	17h 39m	Update successful	A7240	8.0.0.0_55647		
MN-7240-03	<span style="color: green;">●</span>	Good	2	193	17h 39m	Update successful	A7240	8.0.0.0_55647		
MN-7240	<span style="color: green;">●</span>	Good	2	90	17h 38m	Update successful	A7240	8.0.0.0_55647		
MN-7240-02	<span style="color: green;">●</span>	Good	1	124	17h 39m	Update successful	A7240	8.0.0.0_55647		

Upon selecting a managed device from the list, more details are displayed, as shown in the following figure:


**Figure 85 Managed Device Information Page**

**Dashboard**

- Performance
- Network
- Usage
- Potential Issues
- Traffic Analysis
- AirGroup
- UCC
- Controller**
- WLANS
- Access Points
- Clients
- Configuration

Information			
Name:	MN-7240	Access points:	0
Reachability:	Reachable	Clients:	78
Health:	Good	Software:	8.0.0.0_55647
Uptime:	17h 43m 49s	Partition 0:	ArubaOS 8.0.0.0 (Digitally Signed - Production Build) (default boot)
Model:	A7240	Partition 1:	ArubaOS 8.0.0.0-svcs-ctrl (Digitally Signed - Production Build)
Serial Number:	CX0001438	IP address:	10.16.126.16
Country:	United States	IPv6 address:	2001::1
Group:	md > India > Bangalore > 7240-Cluster	MAC address start:	08:00:27:00:00:00
Configuration State:	Update successful	MAC address end:	08:00:27:00:00:07
Configuration Version:	73		

Ports	
	<div style="display: flex; justify-content: space-around; align-items: center;"> <div style="text-align: center;"> <span style="color: green;">U</span> 0                 </div> <div style="text-align: center;"> <span style="color: red;">D</span> 1                 </div> <div style="text-align: center;"> <span style="color: red;">D</span> 2                 </div> <div style="text-align: center;"> <span style="color: red;">D</span> 3                 </div> <div style="text-align: center;"> <span style="color: red;">D</span> 4                 </div> <div style="text-align: center;"> <span style="color: red;">D</span> 5                 </div> </div>
	<div style="display: flex; justify-content: space-between;"> <div> <span style="color: green;">U</span> Up  <span style="color: red;">D</span> Down  <span style="color: gray;">A</span> Admin disabled                 </div> </div>

The **Information** section displays detailed information about the managed device. The **Ports** section displays the status of all the ports in the managed device.

## WLANS

The **WLANS** page displays the WLAN details such as the number of associated APs, radios, wireless clients, and the WLAN usage in managed devices. You can also view the details of the associated APs and clients as tables.

The following sections are available in the WLANS page:

- **WLANS:** The unique SSID of the WLAN, clients connected in the network, APs connected to the WLAN, Radios that are enabled on the AP, Goodput, usage, and the frames transmitted and received by the AP.
- **All WLANS:** The clients, usage, and device distribution information in graphs.

Click the hyperlinked text in the WLANS page to view the following menus with the summary:

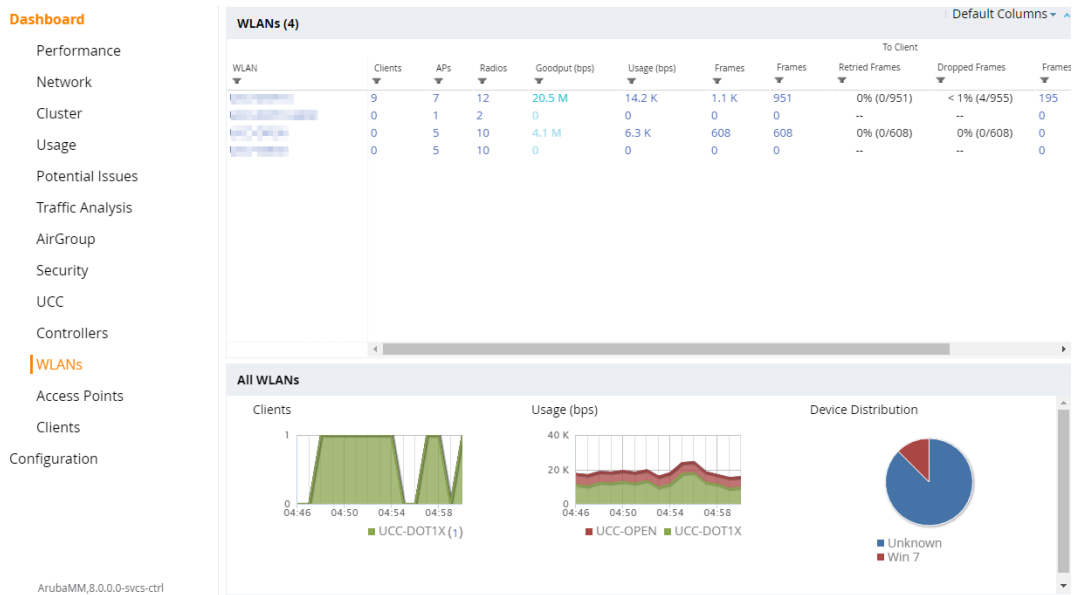
- **Info:** The summary of the WLAN details, frames transmitted and received from and to the client, air quality, and Tx/Rx statistics.
- **Clients:** The summary of WLANs and clients.
- **Radios:** The summary of APs and clients, channel, and its utilization.
- **Charts:** The summary of WLAN details in graphs.
- **Traffic Analysis:** The summary of users, destination, applications, devices and its roles.

You can perform the following tasks on this page:

- **Sort:** Click a column header of the WLAN table to sort the complete list based on the entries on the active column. You can also use the sort icon that appears when you click on a column for sorting.
- **Filter:** Click the filter icon and select the filter criterion on any column of the details table to filter the entries.
- **Customize column view:** Click the drop-down list on the top right corner of the table header and select **Custom Columns**; choose the **Edit Current View** option to select the columns that you want to view. You can also choose one of the following system defined views that have the appropriate pre-selected columns.
  - Default Columns: you cannot edit this view.
  - To/From Client Stats: you can customize this view using the **Edit Current View** option.
- **View WLAN trends:** Click on the hyperlinked client name, the trends of the clients connected in the WLAN and the WLAN usage in the last 15 minutes can be viewed.
- **View client summary:** Click on the hyperlinked client name on the client details table to view the **Client Summary** page. In this page, you can view the client details summary (air quality metrics and from and to clients statistics), bandwidth of the client usage, trend of the client frame loss in the last 15 minutes, and the frame rate distribution of the client.
- **View AP or radio summary:** Click on the hyperlinked AP name or the radio band on the AP details table to view the **Access Points** page. In this page you can view the summary of the AP details such as air quality metrics, from and to clients statistics, and the number of clients associated with the AP under different SNR ranges. Additionally, you can view the details of the associated clients and WLANs.

The following figure shows the **WLANS** page:

**Figure 86** WLANs Page



## Access Points

The **Access Points** page displays the details of all the radios and APs associated with the managed device in the network. By selecting the specific section, you can also view the trends of the connected wireless clients and the client usage under the 2.4 GHz and 5 GHz radio bands in the last 15 minutes.

The **Access Points** page has the following three sections:

- **Access Points**—Displays the AP name, status, uptime, mode, and model details.
- **Radios**—Displays the AP name, band, radio mode, goodput, usage, and the frames transmitted and received by the AP.
- **All Clients**—Displays the clients and usage trend in charts for the last 15 minutes.

You can click the hyperlinked text on the **Access Points** page to view the following menu with the summary:

- **Info**—Displays the summary of the AP details, frames transmitted and received from and to the client, air quality, and Tx/Rx statistics.
- **WLANs & Clients**—Displays the summary of WLANs and clients.
- **Charts**—Displays the summary of clients and its usage in graphs for different bands.
- **History**—Displays the history of channel utilization, frame drops, and frame rates for every minute with histograms for the last 15 minutes.

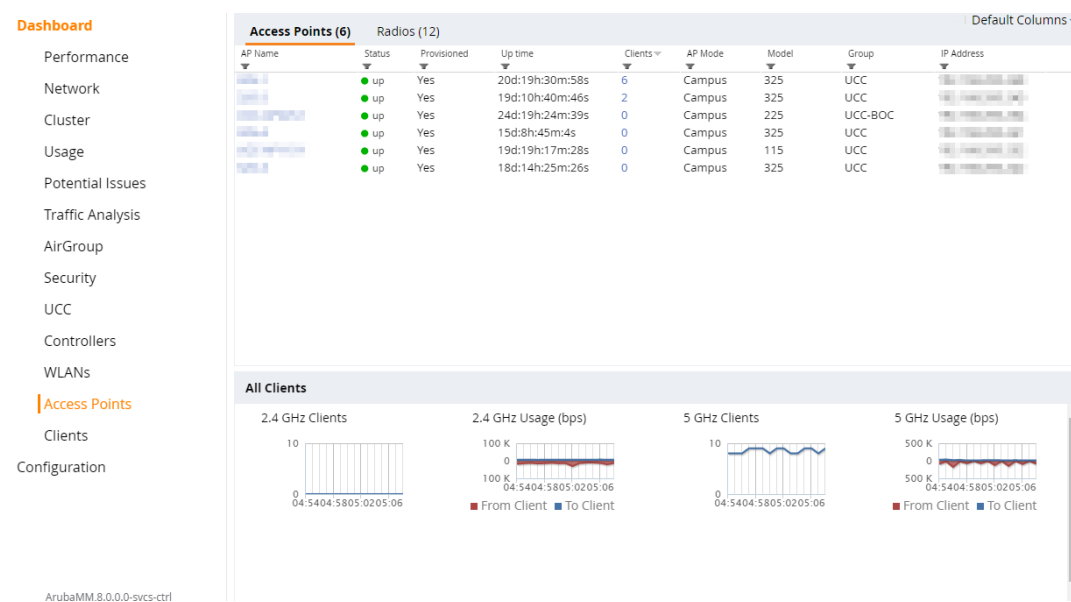
You can perform the following tasks on this page:

- **Sort:** Click a column header of the AP table to sort the complete list based on the entries on the active column. You can also use the sort icon that appears when you click on a column for sorting.
- **Filter:** Click the filter icon and select the filter criterion on any column of the details table to filter the entries.
- **Customize column view:** Click the drop-down list on the top right corner of the table header and select **Custom Columns**; choose the **Edit Current View** option to select the columns that you want to view. You can also choose one of the following system defined views that have the appropriate pre-selected columns.
  - **Default Columns**—You cannot edit this view.
  - **Air Quality Metrics**—You can customize this view using the **Edit Current View** option.

- To/From Client Stats—You can customize this view using the **Edit Current View** option.
- **View client details:** Click on the number of clients associated with the AP to view the details of the clients on the **Clients** page.
- **View AP or radio summary:** Click on the hyperlinked AP name or the radio band on the AP details table to view the summary of the AP details such as air quality metrics, from and to clients statistics, and the number of clients associated with the AP under different SNR ranges. Additionally, you can view the details of the associated clients and WLANs.

The following figure shows the **Access Points** page:

**Figure 87** Access Points Page



## Clients

The **Clients** page displays the details of all the wireless clients on the managed device. You can also view the trends of the connected clients and the client usage under the 2.4 GHz and 5 GHz radio bands in the last 15 minutes.

The **Clients** page displays the following sections:

- **Clients:** The connectivity type, radios, client health, goodput, channel, and the frames transmitted and received.
- **All Clients:** The clients and its usage for 2.4 GHz and 5 GHz bands.

Click the hyperlinked text on the Clients page to view the following menus with the summary:

- **Info:** The summary of the client details, frames transmitted and received from and to the client, air quality, and Tx/Rx statistics.
- **Charts:** The summary of the client details in graphs.
- **AirGroup:** A list of all the far and near end devices that are either accessible or not accessible by the specific client. For more information, see [AirGroup on page 740](#).
- **Firewall:** The summary of traffic in the clients, applications and its roles, and protocols.
- **UCC:** This tab displays an aggregated list of UCC call data metrics of a client. For more information, see [UCC on page 746](#).

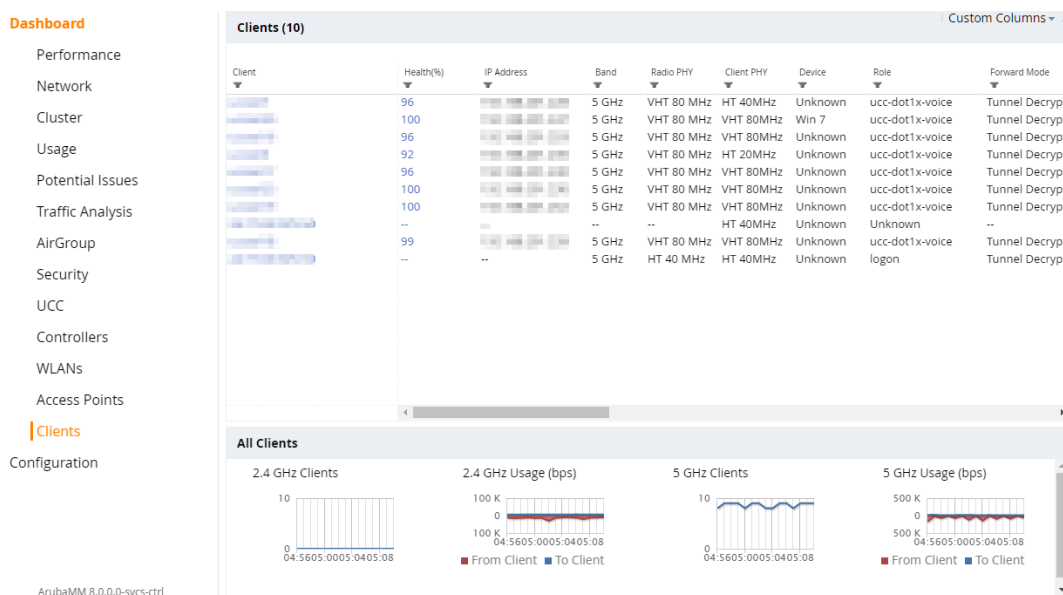
You can perform the following tasks on this page:



- **Sort:** Click a column header of the AP table to sort the complete list based on the entries on the active column. You can also use the sort icon that appears when you click on a column for sorting.
- **Filter:** Click the filter icon and select the filter criterion on any column of the details table to filter the entries.
- **Customize column view:** Click the drop-down list on the top right corner of the table header and select **Custom Columns**; choose the **Edit Current View** option to select the columns that you want to view. You can also choose one of the following system defined views that have the appropriate pre-selected columns.
  - Default Columns: you cannot edit this view.
  - Air Quality Metrics: you can customize this view using the **Edit Current View** option.
  - To/From Client Stats: you can customize this view using the **Edit Current View** option.
- **View client summary:** Click on the hyperlinked client name on the client details table to view the **Client Summary** page. In this page, you can view the client details summary (air quality metrics and from or to clients statistics), bandwidth of the client usage, trend of the client frame loss in the last 15 minutes, and the frame rate distribution of the client.
- **View AP details:** Click on the hyperlinked AP name to view the **Access Points** page.
- **View WLAN details:** Click on the hyperlinked SSID of the WLAN to view the **WLANs** page.

The following figure shows the **Clients** page:

**Figure 88** *Clients Page*



The automatic reporting feature, also known as PhoneHome, allows a Mobility Master to send report events such as hardware failures, software malfunctions, and other critical events. The PhoneHome automatic reporting is disabled by default. When you enable the PhoneHome automatic reporting feature, the Mobility Master sends Aruba support weekly reports about the Mobility Master's configuration, licenses, software and hardware status, and any software malfunctions via Aruba Activate or a secure email. In the event that you need to contact Aruba support with a question about your Mobility Master, you can use this feature to generate and immediately send a status report, so that Aruba support can diagnose the issue with the most current Mobility Master data.

The PhoneHome feature can send reports to Aruba support through the Aruba Activate server using the HTTPS protocol (recommended for most deployments), or send reports to a local SMTP server in email messages.

### Pre-Deployment Information

For information to help you determine whether you should send PhoneHome reports to Aruba support via the Activate server or an SMTP server, see [Registering with Activate on page 754](#)

### Configuration Procedures

For procedures to configure this feature to send reports or to view your Mobility Master's report history, refer to the following topics.

- [Configuring PhoneHome Automatic Reporting on page 755](#)
- [Viewing Report Status on page 757](#)

### Registering with Activate

Before sending PhoneHome reports using Activate, the managed device should be registered with the Activate server using the username/password authentication method. Execute the following steps at the command prompt to register with Activate:

```
(host) [md] (config) #activate
(host) [md] (activate) #username ztp
(host) [md] (activate) #password ztpadmin
(host) [md] (activate) #write memory
Saving Configuration...
Partial configuration for /mm/mynode
-----
Contents of : /flash/config/partial/25/p=sc=mynode.cfg
activate
username "ztp"
password b8698637f6bc63bf5a851a16a2020b816907d92ba8b85a62
!
Configuration Saved.
(host) [md] (activate) #exit
(host) [md] (config) #exit
(host) [md] #show activate
(host) [md] (config)# show activate
activate
-----
Parameter                               Value                               Set
```

-----	-----	---
Activate Whitelist Service	Enabled	
Activate URL	https://activate.arubanetworks.com	
Provision Activate URL	https://device.arubanetworks.com	
Activate Login Username	ztp	
Activate Login Password	*****	
Periodic Interval for WhiteList Download	1	
Add-Only Operation	Enabled	
Custom cert to upload to Activate	N/A	
Server cert to be used for IPSEC	N/A	




---

The **Periodic Interval for WhiteList Download** parameter indicates the whitelist download period in days.

---

## Configuring PhoneHome Automatic Reporting

Use the WebUI or the CLI to configure the Mobility Master to send weekly status reports. When you enable this feature, the Mobility Master sends reports every week by default.

The procedure to configure PhoneHome automatic reporting varies, depending upon whether you want to send reports via Aruba Activate or an SMTP email server. The following procedures describe the tasks to configure automatic reporting using Activate or SMTP.

### Configuring PhoneHome Using Activate

To use the WebUI to configure PhoneHome automatic reporting using Aruba Activate:

1. In the **Mobility Master** node hierarchy, navigate to **Diagnostics > Technical Support > TAC server** tab.
2. Select the **Enable** option in **PhoneHome** to enable this feature.
3. Select **HTTPS** check box in the **HTTPS Configuration** field.
4. In the **Email-ID** field, enter a valid email address with a domain name associated with your Mobility Master. This field is used in the SMTP header and used to validate ownership with PhoneHome data.
5. Use the **Report Type** check boxes to specify whether you want automatic reporting to send regular weekly reports, or a single individual report.
  - Click **Auto Report** to schedule weekly status reports to be sent to Aruba.
  - Click **Report Now** to immediately send a single status report to Aruba.
6. Click **Apply**. If you selected the **Report Now** option in the **Report Type** field, the **Report Now** check box clears, indicating that no additional reports are scheduled to be sent.

### Configuring PhoneHome Using SMTP

To use the WebUI to configure PhoneHome automatic reporting to send reports through an SMTP email server:

1. In the **Mobility Master** node hierarchy, navigate to **Diagnostics > Technical Support > TAC server** tab.
2. Select **Enable** option in the **PhoneHome** to enable this feature.
3. Select **SMTP** option in the **Protocol** field.
4. In the **Server IP Address** field, enter the IP address of your SMTP server. Optionally, in the **Server Port** field, enter the port the Mobility Master should use to access the server.
5. In the **User Name** field, enter the user name of the user from whose email account the reports should be sent. Optionally, if your SMTP server requires the sender to be authenticated, enter a valid sender's user name and password in the **User Name** and **Password** fields.

6. In the **Email ID field**, enter the email address from which the reports should be sent. Optionally, if your SMTP server has limits on email attachment sizes, enter the attachment size in the **Max size of attachment** field. Any status reports larger than this size is divided into multiple emails.
7. Use the **Report Type** check boxes to specify whether you want automatic reporting to send regular weekly reports, or a single individual report.
  - Click **Auto Report** to schedule weekly status reports to be sent to Aruba.
  - Click **Report Now** to immediately send a single status report to Aruba.
8. Click **Apply**.

You can disable automatic reporting at any time by returning to the **Diagnostics > Technical Support > TAC server tab** and either unchecking the **Auto Report** check box, or clicking **disable**.

## Configuring PhoneHome Using the CLI

Issue the following commands to enable or disable automatic reporting, or to identify the Aruba Activate or SMTP server you want to use to send these messages:

```
(host) [mynode] (config) #phonehome
auto-report
https
smtp
```



---

Your SMTP and Activate server settings are preserved even when automatic reporting is disabled.

---

## Sending Reports to Activate vs. SMTP Servers

By default, Mobility Master sends PhoneHome reports to the Activate server using HTTPS.

Most deployments should retain the default behavior introduced in this release and send PhoneHome reports using Activate. However, if the Mobility Master is behind a proxy server and does not have direct access to Internet, PhoneHome should be configured to send reports using SMTP. The following section describes the benefits of each of these configurations options.

### Sending PhoneHome Reports Using Activate

PhoneHome integration with Activate offers the following benefits:

- **Simpler configuration:** PhoneHome only requires you to configure the email ID of the network administrator managing the device, as Activate already has information to accurately identify your Mobility Master. If a DNS server is not configured on the Mobility Master, PhoneHome will query the public DNS service (8.8.8.8) to resolve the Activate server IP address.
- **Smaller bandwidth requirements:** When the PhoneHome feature sends the report to the Activate server, the PhoneHome report is zipped into a smaller package, then divided into smaller 1MB pieces before being sent to the server using secure HTTPS. Only reports sent to Activate are zipped before they are sent, so reports sent to Activate use less bandwidth than a report sent to a SMTP server.
- **Enhanced error management:** If any individual portion of the report is not successfully received by the Activate server, PhoneHome makes up to three attempts to resend just that portion of the file rather than resending the entire report. Reports sent via SMTP must be resent in their entirety if any portion is not received by the SMTP server.
- **Automatic removal of old reports:** Once the entire report has been sent to the Activate server, Activate sends an acknowledgment to the Mobility Master, prompting the Mobility Master to delete its local copy of the report.

- The PhoneHome feature can be enabled or disabled using the **Diagnostics > Technical Support > TAC server** tab in the WebUI. The same can also be done through **phonehome [enable | disable]** option in the CLI.

## Sending Reports Using SMTP

If you configure the PhoneHome feature to use SMTP, the PhoneHome status reports are sent via email. When the Mobility Master generates the report email with the PhoneHome data file attachment, it forwards the email to the local SMTP server configured on your local network, which then relays the message to Aruba technical support. If your email server requires the sender to be authenticated before message delivery, the Mobility Master can connect to the SMTP server by supplying the sender's user name and password.

When PhoneHome reports are sent using SMTP, the PhoneHome report attachment is encrypted before it is transmitted to the SMTP server. It is then decrypted by Aruba support when it is received. If the PhoneHome status report email is larger than the maximum email size supported by your SMTP server, the Mobility Master divides the PhoneHome attachment into smaller attachments and sends the report to Aruba in multiple emails. If any individual portion of the report is not successfully received by the SMTP server, PhoneHome resends the entire report.

## Sending an Individual Report

If you are currently experiencing a problem and have contacted Aruba about the issue, Aruba technical support may ask you to generate and send an individual report, which describes the Mobility Master's current status, and reports any software or hardware errors. Once this report has been successfully uploaded, you may receive an email that contains a unique reference number you can use to track your recently opened ticket.



---

If you have not yet enabled automatic reporting feature or defined an SMTP server for this feature, follow steps 1-9 of the WebUI procedure described in [Configuring PhoneHome Automatic Reporting on page 755](#)

---

### In the WebUI

To generate and send a PhoneHome status report using the WebUI:

1. In the **Mobility Master** node hierarchy, navigate to **Diagnostics > Technical Support > TAC server** tab.
2. Click **Report Now** check box.
3. Click **Apply**.

### In the CLI

To generate and send a PhoneHome status report using the CLI, issue the following command in the *enable* mode.

```
(host) [mynode] (config) #phonehome now
```

## Viewing Report Status

Both the WebUI and CLI can show the status of the automatic reporting feature since the Mobility Master was last reset, including whether this feature is enabled, and the number of report messages that were sent successfully or failed to reach Activate or the SMTP server.

### In the WebUI

To view report status using the WebUI:

1. In the **Mobility Master** node hierarchy, navigate to **Diagnostics > Technical Support > TAC server** tab.

- In the **Protocol** field, select **HTTPS** option and click the **View PhoneHome Report Status** check box to view statistics for sent reports in this window. The **Statistics** and **Transaction History** tables are displayed. These tables contain the following information:

**Table 159: Automatic Reporting Statistics**

Report Statistic	Description
Manual PhoneHome	Number of reports generated by the Mobility Master because the <b>Report Now</b> setting was enabled.
Auto-report	Number of weekly reports generated by the Mobility Master because the <b>Auto Report</b> setting was enabled.
Success	Number of reports successfully sent to Activate or the SMTP server.
Failed	Number of reports that failed to reach Activate or the SMTP server after one or more retry attempts.
Retries	Number of times the Mobility Master attempted to retry sending a report to Activate or the SMTP server.

**Table 160: Transaction History**

Report Statistic	Description
TRANSACTION ID	An ID number for a specific report transaction. This transaction ID includes a timestamp showing when the transaction was first attempted.

## In the CLI

Use the following commands to display statistics for Automatic Reporting settings and report status:

```
(host) [mynode] #show phonehome
global                Display Phonehome global settings
history               Display a history of phonehome transactions

report-status        Display status of reports uploaded to Aruba TAC Server stats
PhoneHome Statistics
```

## PhoneHome-Lite

PhoneHome-Lite is an HTTPS-based tracking tool used to monitor WebCC feature usage on each managed device. Arubamanaged devices communicate with Activate servers over a secure HTTPS SSL through the PhoneHome infrastructure to send information about which users have enabled WebCC. This usage data can then be analyzed to determine the scope of future WebCC feature licensing.

You can enable this feature using the managed device's WebUI or CLI.

### In the WebUI

To enable PhoneHome-Lite in the WebUI:

1. In the **Managed Device** node hierarchy, navigate to **Configuration > Services > Firewall > Global Setting**.
2. In the **Global Setting** accordion, select the **Enable Web Content Classification** check box.  
On enabling, WebCC, the WebCC usage information will be sent to Aruba at every 7 days interval.
3. Click **Submit**.
4. Click **Pending Changes**.
5. In the **Pending Changes** window, select the check box and click **Deploy changes**.

### In the CLI

To enable PhoneHome-Lite using the CLI:

```
(host) [md] #firewall web-cc
```

You can also view the WebCC configuration using the following command:

```
(host) [md] #show firewall
Global firewall policies
```

```
-----
Policy                                     Action           Rate           Port
-----                                     -
Enforce TCP handshake before allowing data Disabled
Prohibit RST replay attack                Disabled
.....
Web Content Classification              Enabled
.....
```

This chapter describes management access and tasks for a user-centric network and includes the following topics:

- [Configuring Certificate Authentication for WebUI Access on page 760](#)
- [Secure Shell \(SSH\) on page 761](#)
- [Enabling RADIUS Server Authentication on page 763](#)
- [Connecting to AirWave Server on page 768](#)
- [Custom Certificate Support for RAP on page 770](#)
- [Implementing Specific Management Password Policy on page 772](#)
- [Configuring Centralized Image Upgrades](#)
- [Managing Certificates on page 776](#)
- [Configuring SNMP on page 782](#)
- [Enabling Capacity Alerts on page 784](#)
- [Configuring Logging on page 786](#)
- [Enabling Guest Provisioning on page 788](#)
- [Managing Files on Managed Device on page 804](#)
- [Setting System Clock on page 807](#)
- [ClearPass Policy Manager Profiling with IF-MAP on page 809](#)
- [Whitelist Synchronization on page 810](#)
- [Downloadable Regulatory Table on page 811](#)

## Configuring Certificate Authentication for WebUI Access

The managed device supports client certificate authentication for users accessing the WebUI. (The default is for username/password authentication.) You can use client certificate authentication only, or client certificate authentication with username/password (if certificate authentication fails, the user can log in with a configured username and password).



---

Each managed device can support a maximum of ten management users.

---

To use client certificate authentication, you must do the following:

1. Obtain a client certificate and import the certificate into the managed device. Obtaining and importing a client certificate is described in [Managing Certificates on page 776](#).
2. Configure certificate authentication for WebUI management. You can optionally also select username/password authentication.
3. Configure a user with a management role. Specify the client certificate for authentication of the user.

### In the WebUI

1. In the **Managed Network** node hierarchy, navigate to the **Configuration > System > Admin** page and click the **Admin Authentication Options** section.



2. Under **WebUI Authentication**, set **Client Certificate** to **Enabled**. You can select **Username/Password** as well; in this case, the user is prompted to manually enter the username and password only if the client certificate is invalid.
3. Select the **Server Certificate** to be used for this service.



---

By default, the **default-self-signed** certificate is used as the server certificate. For more details on **default-self-signed** certificate, see [Managing Certificates on page 776](#).

---

4. Click **Submit**.
5. Click **Pending Changes**.
6. In the **Pending Changes** window, select the check box and click **Deploy changes**.
7. To configure the management user, navigate to the **Configuration > System > Admin** page and click the **Management User** section.
  - a. Select **Enable Local Authentication** as needed.
  - b. Click **Show users with certificate authentication** and click +.
  - c. Select **WebUI certificate**.
  - d. Enter the username.
  - e. Select the user role assigned to the user upon validation of the client certificate.
  - f. Enter the serial number for the client certificate.
  - g. Select the name of the CA that issued the client certificate.
  - h. Click **Submit**.
  - i. Click **Pending Changes**.
  - j. In the **Pending Changes** window, select the check box and click **Deploy changes**.

## In the CLI

```
(host) [md] (config) #web-server profile
(host) [md] (Web Server Configuration) #mgmt-auth certificate
(host) [md] (Web Server Configuration) #switch-cert <certificate>
(host) [md] (Web Server Configuration) #!
(host) [md] (config) #mgmt-user webui-cacert <certificate-name> serial <number> <username>
<rolename>
```

## Secure Shell (SSH)

SSH is enabled by default in ArubaOS, and thus lets you log in using a username and password. You can enable SSH login by using public key authentication while leaving username/password authentication enabled, or you may disable the username/password authentication and leave only the public key authentication enabled. In the FIPS mode of operation, SSH is pre-configured to only use Diffie-Hellman Group 14 with AES-CBC-128 and AES-CBC-256 and HMAC-SHA1/HMAC-SHA1-96. These settings are not configurable.

When you import an X.509 client certificate into the managed device, the certificate is converted to SSH-RSA keys. When you enable public key authentication for SSH, the managed device validates the client's credentials with the imported public keys. You can specify public key authentication only, or public key authentication with username/password (if the public key authentication fails, the user can login with a configured username and password).

### Enabling Public Key Authentication

The managed device allows public key authentication of users accessing the managed device using SSH. (The default is for username/password authentication.)

To use public key authentication, you must do the following:

1. Import the X.509 client certificate into the managed device using the WebUI, as described in [Importing Certificates on page 779](#)
2. Configure SSH for client public key authentication. You can optionally also select username/password authentication.
3. Configure the username, role and client certificate.

### In the WebUI

1. In the **Managed Network** node hierarchy, navigate to the **Configuration > System > Admin** page and select the **Admin Authentication Options** section.
2. Under **SSH (Secure Shell) Authentication Method**, set **Client Public Key** to Enabled. You can optionally select **Username/Password** to use both username/password and public key authentication for SSH access.
3. Click **Submit**.
4. To configure the user, navigate to the **Configuration > System > Admin** page.
  - a. Click **Management User**.
  - b. Click **Show users with certificate authentication**.
  - c. Click +.
  - d. Select **SSH Public Key**.



---

ArubaOS recommends that the username and role for SSH be the same as for the WebUI Certificate. You can optionally use the check box to copy the username and role from the Web Certificate section to the SSH Public Key section.

---

- e. Select the management role assigned to the user upon validation of the client certificate.
- f. Select the client certificate.
- g. Click **Apply**.

### In the CLI

```
ssh mgmt-auth public-key [username/password]
mgmt-user ssh-pubkey client-cert <certificate> <username> <role>
```

## Disabling Console Access

A new command is introduced to disable the console-login. The purpose of this command is to introduce an ability to lock down all console ports, for example, micro USB, mini USB on the managed device to enable high level security.



---

With this command, only console access over serial port, USB, and mini USB will be blocked. SSH/ telnet are still allowed.

---

### In the CLI

To disable the console:

```
(host) [mynode] (config) #mgmt-user console-block
PLEASE SAVE THE CONFIGURATION. CONSOLE WILL BE BLOCKED ONCE USER LOGS OUT FROM SERIALCONSOLE.
```

To re-enable the console:

```
(host) [mynode] (config) #no mgmt-user console-block
```

## Enabling RADIUS Server Authentication

This section include many different types of RADIUS server configuration and related procedures.

### Configuring RADIUS Server Username and Password Authentication

In this example, an external RADIUS server is used to authenticate management users. Upon authentication, users are assigned the default role root.

#### In the WebUI

1. In the **Managed Network** node hierarchy, navigate to the **Configuration > Authentication > Auth Servers** page.
2. Configure the **RADIUS Server**.
  - a. In the **All Servers** section, click +.
  - b. Enter the **Name** for the server (for example, rad1).
  - c. Enter the **IP address**.
  - d. Select **Radius** as the **Type**.
  - e. Click **Submit**.
  - f. Click **Pending Changes**.
  - g. In the **Pending Changes** window, select the check box and click **Deploy changes**.
3. Select **Server Groups** to display the Server Group list.
  - a. Click + and enter the name of the new server group (for example, corp\_rad).
  - b. Click **Submit**.
  - c. Click **Pending Changes**.
  - d. In the **Pending Changes** window, select the check box and click **Deploy changes**.
4. Navigate to the **Configuration > System > Admin** page.
  - a. Under **Admin Authentication Options**, select a management role (for example, root) for the **Default Role**.
  - b. Set **Enable** to **Enabled**.
  - c. For **Server Group**, select the server group that you just configured.
  - d. Click **Submit**.
  - e. Click **Pending Changes**.
  - f. In the **Pending Changes** window, select the check box and click **Deploy changes**.

#### In the CLI

```
aaa authentication-server radius rad1
  host <ipaddr>
  enable
```

```
aaa server-group corp_rad
  auth-server rad1
```

```
aaa authentication mgmt
  default-role root
  enable
  server-group corp_rad
```

## Configuring RADIUS Server Authentication with VSA

In this scenario, an external RADIUS server authenticates management users and returns to the managed device the Aruba vendor-specific attribute (VSA) called Aruba-Admin-Role that contains the name of the management role for the user. The authenticated user is placed into the management role specified by the VSA.

The managed device configuration is identical to the [Configuring RADIUS Server Username and Password Authentication on page 763](#). The only difference is the configuration of the VSA on the RADIUS server. Ensure that the value of the VSA returned by the RADIUS server is one of the predefined management roles. Otherwise, the user will have *no* access to the managed device.

## Configuring RADIUS Server Authentication with Server Derivation Rule



---

Aruba managed device does not make use of any returned attributes from a TACACS+ server.

---

A RADIUS server can return to the managed device a standard RADIUS attribute that contains one of the following values:

- The name of the management role for the user
- A value from which a management role can be derived

For either situation, configure a server-derivation rule for the server group.

In the following example, the RADIUS server returns the attribute Class to the managed device. The value of the attribute can be either "root" or "network-operations" depending upon the user; the returned value is the role granted to the user.



---

Ensure that the value of the attribute returned by the RADIUS server is one of the predefined management roles. Otherwise, the management user will not be granted access to the managed device.

---

### In the WebUI

1. In the **Managed Network** node hierarchy, navigate to the **Configuration > Authentication > Auth Servers** page.
2. Configure the **RADIUS Server**.
  - a. In the **All Servers** section, click +.
  - b. Enter the **Name** for the server (for example, rad1).
  - c. Enter the **IP address**.
  - d. Select **Radius** as the **Type**.
  - e. Click **Submit**.
  - f. Click **Pending Changes**.
  - g. In the **Pending Changes** window, select the check box and click **Deploy changes**.
3. Select **Server Group** to display the Server Group list.
  - a. Enter the name of the new server group (for example, corp\_rad) and click **Add**.
  - b. Select the name to configure the server group.
  - c. Under Servers, click **New** to add a server to the group.
  - d. Select a server from the drop-down list and click **Add Server**.
  - e. Under Server Rules, click **New** to add a server rule.
  - f. For Condition, select **Class** from the scrolling list. Select **value-of** from the drop-down list. Select **Set Role** from the drop-down list.

- g. Click **Add**.
  - h. Click **Submit**.
  - i. Click **Pending Changes**.
  - j. In the **Pending Changes** window, select the check box and click **Deploy changes**.
4. Navigate to the **Configuration > System > Admin** page.
    - a. Under **Admin Authentication Options**, select a management role (for example, root) for the **Default Role**.
    - b. Set **Enable** to **Enabled**.
    - c. For **Server Group**, select the server group that you just configured.
    - d. Click **Submit**.
    - e. Click **Pending Changes**.
    - f. In the **Pending Changes** window, select the check box and click **Deploy changes**.

### In the CLI

```
aaa authentication-server radius rad1
  host <ipaddr>
  enable
```

```
aaa server-group corp_rad
  auth-server rad1
  set role condition Class value-of
```

```
aaa authentication mgmt
  default-role read-only
  enable
  server-group corp_rad
```

In the following example, the RADIUS server returns the attribute Class to the managed device; the value of this attribute can be "it", in which case, the user is granted the root role. If the value of the Class attribute is anything else, the user is granted the default read-only role.

## Configuring Set-value Server-derivation Rule

### In the WebUI

1. In the **Managed Network** node hierarchy, navigate to the **Configuration > Authentication > Auth Servers** page.
2. Select **RADIUS Server** to display the Radius Server List.
  - a. To configure a RADIUS server, enter the name for the server (for example, rad1) and click **Add**.
  - b. Select the name to configure server parameters, such as IP address. Select the **Mode** check box to activate the server.
  - c. Click **Submit**.
  - d. Click **Pending Changes**.
  - e. In the **Pending Changes** window, select the check box and click **Deploy changes**.
3. Select **Server Group** to display the Server Group list.
  - a. Enter the name of the new server group (for example, corp\_rad) and click **Add**.
  - b. Select the name to configure the server group.
  - c. Under Servers, click **New** to add a server to the group.
  - d. Select a server from the drop-down list and click **Add Server**.
  - e. Under Server Rules, click **New** to add a server rule.

- f. For Condition, select **Class** from the scrolling list. Select **equals** from the drop-down list. Enter **it**. Select **Set Role** from the drop-down list. For Value, select **root** from the drop-down list.
  - g. Click **Add**.
  - h. Click **Submit**.
  - i. Click **Pending Changes**.
  - j. In the **Pending Changes** window, select the check box and click **Deploy changes**.
4. Navigate to the **Configuration > Management > Administration** page.
    - a. Under Management Authentication Servers, select a management role (for example, read-only) for the Default Role.
    - b. Select (check) Mode.
    - c. For Server Group, select the server group that you just configured.
    - d. Click **Submit**.
    - e. Click **Pending Changes**.
    - f. In the **Pending Changes** window, select the check box and click **Deploy changes**.

### In the CLI

```

aaa authentication-server radius rad1
    host <ipaddr>
    enable

aaa server-group corp_rad
    auth-server rad1
    set role condition Class equals it set-value root

aaa authentication mgmt
    default-role read-only
    enable
    server-group corp_rad
  
```

For more information about configuring server-derivation rules, see [Configuring Server-Derivation Rules on page 196](#).

## Disabling Authentication of Local Management User Accounts

You can disable authentication of management user accounts in local switches if the configured authentication server(s) (RADIUS or TACACS+) are not available.

You can disable authentication of management users based on the results returned by the authentication server. When configured, locally-defined management accounts (for example, admin) are not allowed to log in if the server(s) are reachable and the user entry is not found in the authentication server. In this situation, if the RADIUS or TACACS+ server is unreachable, meaning it does not receive a response during authentication, or fails to authenticate a user because of a timeout, local authentication is used and you can log in with a locally-defined management account.

### In the WebUI

1. In the **Managed Network** node hierarchy, navigate to the **Configuration > System > Admin** page.
2. Under Management Users, uncheck the **Enable Local Authentication** check box.
3. Click **Submit**.
4. Click **Pending Changes**.
5. In the **Pending Changes** window, select the check box and click **Deploy changes**.

## In the CLI

```
no mgmt-user localauth
```

## Verifying Configuration

To verify if authentication of local management user accounts is enabled or disabled, use the following command:

```
show mgmt-user local-authentication-mode
```

## Resetting Admin or Enable Password

This section describes how to reset the password for the default administrator user account (**admin**) on the managed device. Use this procedure if the administrator user account password is lost or forgotten.

1. Connect a local console to the serial port on the managed device.
2. From the console, login in the managed device using the username **password** and the password **forgetme!**.
3. Enter enable mode by typing in **enable**, followed by the password **enable**.
4. Enter configuration mode by typing in **configure terminal**.
5. To configure the administrator user account, enter **mgmt-user admin root**. Enter a new password for this account. Retype the same password to confirm.
6. Exit from the configuration mode, enable mode, and user mode.

This procedure also resets the enable mode password to **enable**. If you have defined a management user password policy, make sure that the new password conforms to this policy. For details, see [Implementing Specific Management Password Policy on page 772](#).

[Figure 89](#) is an example of how to reset the password. The commands in bold type are what you enter.

**Figure 89** *Resetting the Password*

```
(host)
User: password
Password: forgetme!
(host) >enable
Password: enable
(host) #configure terminal
Enter Configuration commands, one per line. End with CNTL/Z

(host) (config) #mgmt-user admin root
Password: *****
Re-Type password: *****
(host) (config) #exit
(host) #exit
(host) >exit
```

After you reset the administrator user account and password, you can login to the managed device and reconfigure the enable mode password. To do this, enter configuration mode and type the **enable secret** command. You are prompted to enter a new password and retype it to confirm. Save the configuration by entering **write memory**.

[Figure 90](#) details an example reconfigure the enable mode password. Again, the command you enter displays in bold type.

**Figure 90** Reconfigure the enable mode password

```
User: admin
Password: *****
(host) >enable
Password: *****
(host) #configure terminal
Enter Configuration commands, one per line. End with CNTL/Z

(host) (config) #enable secret
Password: *****
Re-Type password: *****
(host) (config) #write memory
```

## Bypassing Enable Password Prompt

The bypass enable feature lets you bypass the enable password prompt and go directly to the privileged commands (config mode) after logging on to the managed device. This is useful if you want to avoid changing the enable password due to company policy.

Use the `enable bypass` CLI command to bypass the enable prompt and go directly to the privileged commands (config mode). Use the `no enable bypass` CLI command to restore the enable password prompt.

## Setting Administrator Session Timeout

You can configure the number of seconds after which an administrator's WebUI or CLI session times out.

### For WebUI

To define a timeout interval for a WebUI session, use the command:

```
(host) [md] (config) #web-server profile
(host) [md] (Web Server Configuration) #session-timeout <session-timeout>
```

In the above command, **<session-timeout>** can be any number of seconds from 30 to 3600, inclusive.

### For CLI

To define a timeout interval for a CLI session, use the command:

```
(host) [md] (config) #login-session timeout <value>
```

In the above command, **<val>** can be any number of minutes from 5 to 60 or seconds from 1 to 3600, inclusive. You can also specify a timeout value of 0 to disable CLI session timeouts.

## Connecting to AirWave Server

AirWave is a powerful and easy-to-use network operations system that manages wireless, wired and remote access networks, as well as wireless and wired infrastructures and a wide range of third-party manufacturers.

Managed devices can use the **Configuration > System > AirWave** section of WebUI to quickly and easily connect the managed device to an AirWave server. The following table lists the information you will need to connect a managed device to an AirWave server.



**Table 161:** *AirWave Wizard Checklist*

Information	Description
AirWave IP address	IP address of the AirWave server.
SNMP version	Specify if the managed device and AirWave server should communicate using SNMP v2 or SNMP v3. SNMPv3 communication between a managed device and an AirWave server use SHA authentication and AES encryption.

## AMON Message Size Changes

Data communication between managed devices and AirWave servers has shifted from the SNMP model to the faster, more reliable, and scalable AMON model. Though the SNMP model can still be used to communicate data, users generally encounter delayed AirWave updates and high CPU usage.

The AMON packet size has been capped at a default value of 1400 bytes to reduce the amount of fragmentation and message loss that typically occurs in larger packet sizes, which can force customers to fall back to the SNMP model. Message size has been capped at 1400 bytes to allow for the addition of AMON headers and PAPI/UDP/IP headers. Each packet only contains one message to further reduce the amount of overall message loss, as the loss of even a single fragment can render an entire message invalid.

The AMON packet size can be modified using the following CLI command:

```
amon msg-buffer-size <msg-buffer-size>
```

With the additional message load due to the smaller packet size and 1:1 message to packet ratio, output has also been increased from 10 second intervals to 1 second intervals to distribute packets more evenly, helping maintain a more stable and less congested traffic flow.

## Clarity Synthetic

Mobility Master provides support for Clarity Synthetic, which helps in detecting network health by using synthetic transaction from a Wi-Fi client. This feature converts the radios of a supported access point to switch from AP mode to station mode. The managed device converts one or both of the radios of the AP to station mode based on the instruction from a network management server. When the radio of the AP is in station mode, it starts synthetic data transaction within the network.

The following table provides a list of AP platforms that support Clarity Synthetic:

**Table 162:** *Supported AP-Platforms for Clarity Synthetic*

Supported AP-Platforms
200 Series access points
210 Series access points
220 Series access points

The network health is determined based on the response from the network and the time taken for the synthetic data transaction. The results captured as part of these transactions are used for the following purposes:

- Troubleshoot a live network
- Provide whole network overview (WLAN and Wired)
- Support Wi-Fi and Internet protocol service level agreement (IP SLA)

- Troubleshoot Remote network using client traffic (Synthetic)

## Custom Certificate Support for RAP

As Suite-B mandates using the AES-GCM encryption and ECDSA certificates for security, this feature allows you to upload custom RSA and ECDSA certificates to a RAP. This allows custom certificates to be used for IKEv2 negotiation which establishes a tunnel between the RAP and the managed device. Feature support includes the ability to:

- Upload a single CA certificate and RAP certificate which have either elliptical crypto key parameters with ECDSA or RSA parameters for signing and verification.
- Store the certificate in the flash of the RAP
- Store CSR and private key files in a USB
- Delete certificates
- Generate a CSR paired with a private key generation for the RAP. The private key is stored in the flash and the CSR can be exported out of the RAP to get it signed by the CA.

If there is a custom certificate present in the flash when rebooting, this feature creates a suite B tunnel with the managed device if the certificates uploaded are using EC algorithms. Otherwise it creates a tunnel using standard RAP IPsec parameters.

### Suite-B Support for ECDSA Certificate

If a custom ECDSA certificate is present in the flash of a certificate-based RAP, it is automatically designated as a Suite-B RAP. On the managed device side, tunnel creation uses the server certificate as a default VPN server certificate.

Administering Suite-B support for a RAP includes these steps which are described in the following sections:

1. Setting the Default Server Certificate
2. Import a custom certificate
3. Generate a Certificate Signing Request (CSR)
4. Upload the certificate

### Setting Default Server Certificate

#### In the CLI

To set the default server certificate that is presented to the RAP as the default VPN server certificate:

```
(host) [md] (config) #crypto-local isakmp server-certificate  
<server_certificate_name>
```

To add the CA certificate to verify the RAP certificate:

```
(host) [md] (config) #crypto-local isakmp ca-certificate <trusted CA>
```

#### Importing a Custom Certificate

Certificates can only be imported to the managed device using the WebUI.

#### In the WebUI

1. In the **Managed Network** node hierarchy, navigate to **Configuration > System > Certificates** and upload the certificate.
2. To use imported certificates to create a tunnel, in the Managed Device node hierarchy, navigate to **Configuration > Services > VPN > Certificates for VPN Clients**.

## Generating CSR

The RAP console page allows you to generate a CSR. This is done through a private key which can be generated and saved to the RAP flash. A corresponding CSR is exported so it can be signed by the required CA to use as the RAP certificate. This RAP certificate can then be uploaded using the Upload button on the RAP Console page.

The subject of the RAP certificate needs to be the MAC address of the RAP, and nothing more. Note that this is case insensitive.

If you create a CSR on the RAP and then have a certificate issued by a CA, you must have the certificate in PEM format before uploading it to the RAP.

## Uploading Certificate



---

When using the “rapconsole.arubanetworks.com” page on a bridge/split-tunnel RAP to manage certificates on the RAP, a blank page or a page that does not have the Certificates tabs on it may display. The RAP provisioning page that is standard on the RAP may conflict with the “rapconsole” page and thus confuse the browser. If this occurs, clear your browser cache first or use two different browsers.

---

The Upload button on the RAP console page that lets you upload the certificates to the RAP flash. The certificate needs to be in PEM format and uploading the RAP certificate requires that the corresponding private key is present in the RAP flash. Or, use the PKCS12 bundle where the chain includes the RAP private key with the RAP and CA certificates are optionally password protected.

## Storing CSR and Private Key Files in USB

To provision a RAP to store the CSR and private key in a USB, use one of the following options:

### AP Boot Prompt

At the AP boot prompt, issue the **setenv usb\_csr 1** and **setenv usb\_type 100** commands.



---

If this option is used to provision the RAP to store the files in the USB device, after the files are saved in the USB, enter the AP boot prompt to issue the **setenv usb\_csr 0** command. This is mandatory.

---

### In the WebUI

1. In the **Managed Network** node hierarchy, navigate to **Configuration > Wireless > AP Installation > Provisioning**.
2. Select the RAP, click **Provision**.
3. Under **USB Settings**, select the **USB Parameters** check box.
4. Select the **USB storage for CSR/Key** check box.
5. Select **Device Type** as **storage**.
6. Click **Apply and Reboot**.

### In the CLI

```
(host) [md] (config) #provision-ap
(host) [md] (AP provisioning) #read-bootinfo ap-name <ap name>
(host) [md] (AP provisioning) #usb-csr
(host) [md] (AP provisioning) #usb-type storage
```

### RAP Console

1. In the **Managed Network** node hierarchy, navigate to **Configuration > Management > Certificates**.
2. For **Store CSR and key in USB/Flash**, select **USB** from the drop-down list.

After the RAP is provisioned to store the CSR and private key in a USB, log in to the RAP console, export the CSR and private key files to the USB. A **.p12** certificate file format must be manually created as the RAP certificate in the USB to bring up the IKE/IPsec connection.

## Implementing Specific Management Password Policy

By default, the password for a new management user has no requirements other than a minimum length of 6 alphanumeric or special characters. However, if your company enforces a best practices password policy for management users with root access to network equipment, you may want to configure a password policy that sets requirements for management user passwords.

### Defining Management Password Policy

To define specific management password policy settings through the WebUI or the CLI, complete the following steps:

#### In the WebUI

1. In the **Managed Network** node hierarchy, navigate to **Configuration > System > Profiles**.
2. Expand **Other Profiles**.
3. Select **Mgmt Password Policy**.
4. Configure the settings described in [Table 163](#).

**Table 163:** *Management Password Policy Settings*

Parameter	Description
Enable Password Policy	Select this check box to enable the password management policy. The password policy will not be enforced until this check box is selected.
Minimum password length required	The minimum number of characters required for a management user password Range: 6-64 characters. Default: 6.
Minimum number of Upper Case characters	The minimum number of uppercase characters required in a management user password. Range: 0-10 characters. By default, there is no requirement for uppercase letters in a password, and the parameter has a default value of 0.
Minimum number of Lower Case characters	The minimum number of lowercase characters required in a management user password. Range: 0-10 characters. By default, there is no requirement for lowercase letters in a password, and the parameter has a default value of 0.
Minimum number of Digits	The minimum number of numeric digits required in a management user password. Range: 0-10 digits. By default, there is no requirement for numerical digits in a password, and the parameter has a default value of 0.

**Table 163: Management Password Policy Settings**

Parameter	Description
Minimum number of Special characters (!, @, #, \$, %, ^, &, *, <, >, {, }, [, ], :, ;, ., comma,  , +, ~, `)	The minimum number of special characters. Range: 0-10 characters.
Username or Reverse of username NOT in Password	When you select this check box, the password cannot be the management users' current username or the username spelled backwards.
Maximum consecutive character repeats	The maximum number of consecutive repeating characters allowed in a management user password. Range: 0-10 characters. By default, there is no limitation on the numbers of character that can repeat within a password, and the parameter has a default value of 0 characters.
Maximum Number of failed attempts in 3 minute window to lockout user	The number of failed attempts within a 3 minute window that causes the user to be locked out for the period of time specified by the <b>Time duration to lockout the user upon crossing the "lock-out" threshold</b> parameter. Range: 0-10 attempts. By default, the password lockout feature is disabled, and the default value of this parameter is 0 attempts.
Time duration to lock out the user upon crossing the "lock-out" threshold	The duration in time that locks out the user upon crossing the lock out threshold. Range: 0-60 in minutes.

5. Click **Submit**.
6. Click **Pending Changes**.
7. In the **Pending Changes** window, select the check box and click **Deploy changes**.

### In the CLI

```
aaa password-policy mgmt
```

## Management Authentication Profile Parameters

[Table 164](#) describes configuration parameters on the Management Authentication profile page.



---

In the CLI, you configure these options with the **aaa authentication mgmt** and **aaa-server-group** commands.

---

**Table 164:** Management Authentication Profile Parameters

Parameter	Description
Enable	Enables authentication for administrative users.
Default Role	Select a predefined management role to assign to authenticated administrative users:
Root	Default superuser role
guest-provisioning	Guest provisioning role
location-api-mgmt	Location API role
network-operations	Network operations role
no-access	No commands are accessible for this role
read-only	Read-only role
no access	Negates any configured parameter.
Server Group	Name of the group of servers used to authenticate administrative users. See the CLI command <b>aaa-server-group</b> , in the <i>CLI Command Reference Guide</i> for more information.

## Configuring Centralized Image Upgrades

The centralized image upgrade feature allows the Mobility Master to upgrade itself and its associated managed devices by sending an image from the image server to one or more managed devices.

The Mobility Master connects to an image server, downloads the image file for each managed device, and verifies the validity of the image files. After the Mobility Master verifies the validity of the image files, the managed devices connect to the image server, download the appropriate image file, and upgrade to the downloaded image file.



### Configuring Upgrade Profile on Managed Device

Configure the upgrade profile on the managed devices.

#### In the WebUI

1. In the **Managed Network** node hierarchy, navigate to **Configuration > System > Profiles**.

- Under **All Profiles**, select **Controller Profile > Upgrade**.
- Under **Upgrade Profile**, configure the parameters listed in the following table.

**Table 165:** *Upgrade Profile Parameters*

Parameter	Description
Server IP address	Specify the IP address of the image server. <b>NOTE:</b> For the FTP or SCP protocol, specify the username and password.
Username	Specify the username of the image server.
Password	Specify the password of the image server.
Retype	Repeat the password of the image server.
Protocol	Select the protocol used to download the image file from the image server to the managed devices. <ul style="list-style-type: none"> <li>None</li> <li>tftp</li> <li>ftp</li> <li>scp</li> </ul> <b>NOTE:</b> Select none for local file.
File path	Specify the path of the image file on the image server.

- Click **Save**.
- Click **Pending Changes**.
- In the **Pending Changes** window, select the required check box and click **Deploy changes**.

## Upgrading Managed Device

Use the following procedure to upgrade the required managed devices.

### In the WebUI

- In the **Managed Network** node hierarchy, navigate to **Configuration > Tasks**.
- Under **Tasks**, click **Upgrade controllers**.
- Under **Controllers in Group**, select the managed devices to upgrade.
- Click **Next**.
- Select how to upgrade the selected managed devices.
  - Use upgrade profile in group hierarchy - Uses the image server configured in the upgrade profile of the managed device.
  - Use specified image server - Uses the specified image server configuration. Configure the parameters listed in the following table.

**Table 166:** *Image Server Access Parameters*

Parameter	Description
IP address	Specify the IP address of the image server. <b>NOTE:</b> For the FTP or SCP protocol, specify the username and password.
Image path	Specify the path of the image file on the image server. <b>NOTE:</b> To specify default path, use .
Protocol	Select the protocol used to download the image file from the image server to the managed devices. <ul style="list-style-type: none"><li>• TFTP</li><li>• FTP</li><li>• SCP</li></ul> <b>NOTE:</b> For the FTP or SCP protocol, specify the username and password.

6. Click **Next**.
7. Select how to upgrade the selected managed devices and specify a value against **Upgrade to**.
  - version
  - file
  - force-version
  - force-file
8. Select the **Auto-reboot** check box to reboot the selected managed devices after the upgrade.
9. Select the partition on the selected managed devices to upgrade against **Partition**.
  - auto - Upgrades the default boot partition on the selected managed devices.
  - partition 0 - Upgrades partition 0 on the selected managed devices.
  - partition 1 - Upgrades partition 1 on the selected managed devices.
10. Click **Finish**.

## Managing Certificates

The Mobility Master is designed to provide secure services through the use of digital certificates. Certificates provide security when authenticating users and computers and eliminate the need for less secure password-based authentication.

Starting from ArubaOS 8.0.1, Mobility Master and managed devices generate a default certificate (controller-issued server certificate) to demonstrate the authentication of the managed device for captive portal and WebUI management access while booting. The controller-issued server certificate is used as the default certificate for WebUI authentication, 802.1X termination, and Single Sign-On (SSO).



---

The default-self-signed server certificate in ArubaOS 8.0 is changed to controller-issued server certificate in ArubaOS 8.0.1.

---

Aruba *strongly* recommends that you replace the default certificate with a custom certificate issued for your site or domain by a trusted Certificate Authority (CA). This section describes how to generate a Certificate



Signing Request (CSR) to submit to a CA and how to import the signed certificate received from the CA into the managed device.

The managed device supports client authentication using digital certificates for specific user-centric network services, such as AAA FastConnect, VPN (see [Virtual Private Networks on page 338](#)), and WebUI and SSH management access. Each service can employ different sets of client and server certificates.

During certificate-based authentication, the managed device provides its server certificate to the client for authentication. After validating the managed device's server certificate, the client presents its own certificate to the managed device for authentication. To validate the client certificate, the managed device checks the certificate revocation list (CRL) maintained by the CA that issued the client certificate. After validating the client's certificate, the managed device can check the user name in the certificate with the configured authentication server (this action is optional and configurable).



---

When using X.509 certificates for authentication, if a banner message has been configured on the managed device, it displays before the user can login. Click on the **Login** button after viewing the banner message to complete the login process.

---

## About Digital Certificates

Clients and the servers to which they connect may hold authentication certificates that validate their identities. When a client connects to a server for the first time, or the first time since its previous certificate has expired or been revoked, the server requests that the client transmit its authentication certificate. The client's certificate is then verified against the CA which issued it. Clients can also request and verify the server's authentication certificate. For some applications, such as 802.1X authentication, clients do not need to validate the server certificate for the authentication to function.

Digital certificates are issued by a CA which can be either a commercial, third-party company or a private CA controlled by your organization. The CA is trusted to authenticate the owner of the certificate before issuing a certificate. A CA-signed certificate guarantees the identity of the certificate holder. This is done by comparing the digital signature on a client or server certificate to the signature on the certificate for the CA. When CA-signed certificates are used to authenticate clients, the managed device checks the validity of client certificates using certificate revocation lists (CRLs) maintained by the CA that issued the certificate.

Digital certificates employ public key infrastructure (PKI), which requires a private-public key pair. A digital certificate is associated with a private key, known only to the certificate owner, and a public key. A certificate encrypted with a private key is decrypted with its public key. For example, party A encrypts its certificate with its private key and sends it to party B. Party B decrypts the certificate with party A's public key.

## Obtaining Server Certificate

Best practices is to replace the default server certificate in the managed device with a custom certificate issued for your site or domain by a trusted CA. To obtain a security certificate for the managed device from a CA:

1. Generate a Certificate Signing Request (CSR) on the managed device using either the WebUI or CLI.
2. Submit the CSR to a CA. Copy and paste the output of the CSR into an email and send it to the CA of your choice.
3. The CA returns a signed server certificate and the CA's certificate and public key.
4. Install the server certificate, as described in [Importing Certificates on page 779](#).



---

There can be only one outstanding CSR at a time in the managed device. Once you generate a CSR, you need to import the CA-signed certificate into the managed device before you can generate another CSR.

---

## In the WebUI

1. In the **Managed Network** node hierarchy, navigate to the **Configuration > System > Certificates** page and click the **CSR** section.
2. Enter the following information:

**Table 167: CSR Parameters**

Parameter	Description	Range
CSR Type	Type of the CSR. You can generate a certificate signing request either with an Elliptic curve (EC) key, or with a Rivest-Shamir-Aldeman (RSA) key.	ec/rsa
Curve name	Length of the private/public key for ECDSA. This is applicable only if <b>CSR Type</b> is <code>ec</code> .	secp256r1/secp384r1
Key Length	Length of the private/public key for RSA. This is applicable only if <b>CSR Type</b> is <code>rsa</code> . <b>NOTE:</b> RSA-1024 is not permitted if the managed device is operating in the FIPS mode.	1024/2048/4096
Common Name	Typically, this is the host and domain name, as in <code>www.example.com</code> .	—
Country	Two-letter ISO country code for the country in which your organization is located.	
State/Province	State, province, region, or territory in which your organization is located.	
City	City in which your organization is located.	
Organization	Name of your organization.	
Unit	Optional field to distinguish a department or other unit within your organization.	
Email Address	Email address referenced in the CSR.	

3. Click **Generate New**.
4. Click **View Current** to display the generated CSR. Select and copy the CSR output between the BEGIN CERTIFICATE REQUEST and END CERTIFICATE REQUEST lines, paste it into an email and send it to the CA of your choice.

## In the CLI

1. Run the following command:

```
crypto pki csr {rsa key_len <key_val> |{ec curve-name <key_val>} common_name <common_val>  
country <country_val> state_or_province <state> city <city_val> organization <organization_val>  
unit <unit_val> email <email_val>
```



---

RSA-1024 is not permitted if the managed device is operating in the FIPS mode.

---

2. Display the CSR output with the following command:

```
show crypto pki csr
```

3. Copy the CSR output between the BEGIN CERTIFICATE REQUEST and END CERTIFICATE REQUEST lines, paste it into an email and send it to the CA of your choice.

## Obtaining Client Certificate

You can use the CSR generated on the managed device to obtain a certificate for a client. However, since there may be a large number of clients in a network, you typically obtain client certificates from a corporate CA server. For example, in a browser window, enter `http://<ipaddr>/crtserv`, where `<ipaddr>` is the IP address of the CA server.

## Importing Certificates

Use the WebUI or the CLI to import certificates into the managed device.



---

You cannot export certificates from the managed device.

---

You can import the following types of certificates into the managed device:

- Server certificate signed by a trusted CA. This includes a public and private key pair.
- CA certificate used to validate other server or client certificates. This includes only the public key for the certificate.
- Client certificate and client's public key. (The public key is used for applications such as SSH which does not support X509 certificates and requires the public key to verify an allowed certificate.)

Certificates can be in the following formats:

- X509 PEM unencrypted
- X509 PEM encrypted with a key
- DER
- PKCS7 encrypted
- PKCS12 encrypted

### In the WebUI

1. In the **Managed Network** node hierarchy, navigate to the **Configuration > System > Certificates** page.
2. In the **Import Certificates** table click +.
3. For **Certificate Name**, enter a user-defined name.
4. For **Certificate Filename**, click **Browse** to navigate to the appropriate file on your computer.
5. If the certificate is encrypted, enter and repeat the passphrase.
6. Select the **Certificate Format** from the drop-down list.
7. Select the **Certificate Type** from the drop-down list.
8. Click **Submit**.
9. Click **Pending Changes**.
10. In the **Pending Changes** window, select the required check box and click **Deploy changes**.

## In the CLI

Use the following command to import CSR certificates:

```
crypto pki-import {der|pem|pfx|pkcs12|pkcs7} {PublicCert|ServerCert|TrustedCA} <name>
```

The following example imports a server certificate named **cert\_20** in DER format:

```
crypto pki-import der ServerCert cert_20
```

## Viewing Certificate Information

In the WebUI, the Certificate Lists section of the page lists the certificates that are currently installed in the managed device. Click **View** to display the contents of a certificate.

To view the contents of a certificate with the CLI, use the following commands:

**Table 168:** *Certificate Show Commands*

Command	Description
<pre>show crypto-local pki trustedCAs [&lt;name&gt;] [&lt;attribute&gt;]</pre>	Displays the contents of a trusted CA certificate. If a name is not specified, all CA certificates imported into the managed device are displayed. If name and attribute are specified, then only the attribute in the certificate are displayed. Attributes can be CN, validity, serial-number, issuer, subject, public-key.
<pre>show crypto-local pki serverCerts [&lt;name&gt;] [&lt;attribute&gt;]</pre>	Displays the contents of a server certificate. If a name is not specified, all server certificates imported into the managed device are displayed.
<pre>show crypto-local pki publiccert [&lt;name&gt;] [&lt;attribute&gt;]</pre>	Displays the contents of a public certificate. If a name is not specified, all public certificates imported into the managed device are displayed.

## Imported Certificate Locations

Imported certificates and keys are stored in the following locations in flash on the managed device:

**Table 169:** *Imported Certificate Locations*

Location	Description
<code>/flash/certmgr/trustedCAs</code>	Trusted CA certificates, either for root or intermediate CAs. Best practices is to import the certificate for an intermediate CA, you also import the certificate for the signing CA.
<code>/flash/certmgr/serverCerts</code>	Server certificates. These certificates must contain both a public and private key (the public and private key must match). You can import certificates in PKCS12 and X509 PEM formats, but they are stored in X509 PEM DES encrypted format.
<code>/flash/certmgr/CSR</code>	Temporary certificate signing requests (CSRs) that have been generated on the managed device and are awaiting a CA to sign them.
<code>/flash/certmgr/publiccert</code>	Public key of certificates. This allows a service on the managed device to identify a certificate as an allowed certificate.

## Checking CRLs

A CA maintains a CRL that contains a list of certificates that have been revoked before their expiration date. Expired client certificates are not accepted for any user-centric network service. Certificates may be revoked because certificate key has been compromised or the user specified in the certificate is no longer authorized to use the key.

When a client certificate is being authenticated for a user-centric network service, the managed device checks with the appropriate CA to make sure that the certificate has not been revoked.



---

The managed device does not support download of CRLs.

---

## Certificate Expiration Alert

The certificate expiration alert sends alerts when installed certificates, which correspond to trust chains, OSCP responder certificates, and any other certificates installed on the device. By default, the system sends this alert 60 days before the expiration of the installed credentials. This alert is then repeated periodically on a weekly or biweekly basis. This alerts consist of two SNMP traps:

- wlsxCertExpiringSoon
- wlsxCertExpired

## Chained Certificates on the RAP

Chained certificates on the RAP (that is, certificates from a multi-level PKI) need to be in a particular order inside the file. The RAP's certificate must be first, followed by the certificate chain in order, and then followed by the private key for the certificate. For example, with a root CA, a single intermediate CA, and a root CA, the PEM or PKCS12 file must contain the following parts, in this order:

1. RAP Certificate
2. Intermediate CA
3. Root CA
4. Private key



---

If this order is not followed, certificate validation errors occur. This order also applies to server certificates.

---

## Support for Certificates on USB Flash Drives

This release now supports storing RAP certificates in a USB device. This ensures that the RAP certificate is activated only when the USB with the corresponding certificate is connected to the RAP. If the USB is removed from the RAP, the RAP certificate is deactivated and when the USB is connected to the RAP it acts a storage device and not as a 3G/4G RAP.

The RAP supports only PKCS12-encoded certificates that are present in the USB. This certificate contains all the information that is required for creating the tunnel including the private key, RAP certificate with the chain of certificates, and the trusted CA certificate. There is a limit of three supported intermediate CAs.

Ensure you adhere to the following file naming guidelines when you are saving the certificate:

- The first twelve characters of the certificate file name should be the RAP's MAC address. For example, if RAP's eth0 MAC address is 00:0b:86:c2:00:6c, then the file name will be 000B86C2006C.P12 or 000B86C2006C\_rap155.p12
- All alphabets of the MAC address in the file name should be in upper case.

- The file name can have additional characters after the MAC address separated by "\_" for the purpose of identification.

If this naming convention is not followed a error will occur during certificate validation.

Follow the steps below to configure the USB certificate store:

1. Copy the PKCS12 certificate bundle to a USB device.
2. Enter a name for the certificate using the correct naming convention as mentioned above.



---

In the USB connected to the RAP, delete any duplicate <mac-address>.p12 certificate file. Only one such file must be present in the USB.

---

If you unplug the USB device the RAP will become unresponsive. Reboot the RAP to bring it up with a custom certificate, if the USB device was unplugged.

## Marking the USB Device Connected as a Storage Device

If the AP provisioning parameter "usb-type" contains the value "storage," this indicates that the RAP will retrieve certificates from the connected USB flash drive.

## RAP Configuration Requirements

The RAP needs to have one additional provisioning parameter, the pkcs12\_passphrase, which can be left untouched or can store an ACSII string. The string assigned to this parameter is used as the passphrase for decoding the private key stored.



---

If you have an activated RAP that is using USB storage for the certificate, and you remove the USB storage, the RAP drops the tunnel. This is by design. However, for the RAP to re-establish the tunnel it has to be power cycled. It does not matter if you reinsert the USB storage before or after the power cycle as long as you power cycle it.

---

When the RAP successfully extracts all the information including the CA certificate, the RAP certificate and the RAP private key using the passphrase from the provisioning parameter, it successfully establishes the tunnel.

## Configuring SNMP

Managed devices support versions 1, 2c, and 3 of Simple Network Management Protocol (SNMP) for reporting purposes only. In other words, SNMP cannot be used for setting values in a system in the current ArubaOS version.



---

Aruba-specific management information bases (MIBs) describe the objects that can be managed using SNMP.

---

## SNMP Parameters

You can configure the following SNMP parameters.

**Table 170: SNMP Parameters**

Field	Description
Host Name	Host name of the managed device.
System Contact	Name of the person who acts as the System Contact or administrator for the managed device.
System Location	String to describe the location of the managed device.
Read Community Strings	Community strings used to authenticate requests for SNMP versions before version 3. <b>NOTE:</b> This is needed only if using SNMP v2c and is not needed if using version 3.
Enable Trap Generation	Enables generation of SNMP traps to configured SNMP trap receivers. Refer to the list of traps in the “SNMP traps” section below for a list of traps that are generated by the managed device.
Trap receivers	Host information about a trap receiver. This host needs to be running a trap receiver to receive and interpret the traps sent by the managed device. Configure the following for each host/trap receiver: <ul style="list-style-type: none"> <li>• IP address</li> <li>• SNMP version: can be 1, 2c, or 3.</li> <li>• Type: Trap or Inform (SNMPv2c or SNMPv3 only)</li> <li>• Engine ID: (SNMPv3 only)</li> <li>• Security string</li> <li>• UDP port on which the trap receiver is listening for traps. The default is the UDP port number 162. This is optional, and will use the default port number if not modified by the user.</li> </ul>
If you are using SNMPv3 to obtain values from the managed device, you can configure the following parameters:	
User name	A string representing the name of the user.
Authentication protocol	An indication of whether messages sent on behalf of this user can be authenticated, and if so, the type of authentication protocol used. This can take one of the two values: <ul style="list-style-type: none"> <li>• MD5: HMAC-MD5-96 Digest Authentication Protocol</li> <li>• SHA: HMAC-SHA-96 Digest Authentication Protocol</li> </ul>

Field	Description
Authentication protocol password	If messages sent on behalf of this user can be authenticated, the (private) authentication key for use with the authentication protocol. This is a string password for MD5 or SHA depending on the choice above.
Privacy protocol	An indication of whether messages sent on behalf of this user can be protected from disclosure, and if so, the type of privacy protocol which is used. This takes the value DES (CBC-DES Symmetric Encryption Protocol).
Privacy protocol password	If messages sent on behalf of this user can be encrypted/decrypted with DES, the (private) privacy key for use with the privacy protocol.

Follow the steps below to configure basic SNMP parameters.

### In the WebUI

1. In the **Managed Network** node hierarchy, navigate to the **Configuration > System > SNMP** page.
2. If the managed device will be sending SNMP traps, click + in the Trap Receivers section to add a trap receiver.
3. If you are using SNMPv3 to obtain values from the managed device, click + in the Users for SNMPv3 section to add a new SNMPv3 user.
4. Click **Submit**.
5. Click **Pending Changes**.
6. In the **Pending Changes** window, select the check box and click **Deploy changes**.

### In the CLI

```
hostname name
syscontact name
syslocation string
snmp-server community string
snmp-server enable trap
snmp-server engine-id engine-id
snmp-server host ipaddr version {1|2c|3} string [udp-port number]
snmp-server trap source ipaddr
snmp-server user name [auth-prot {md5|sha} password priv-prot DES password
```



Earlier versions of ArubaOS supported SNMP on individual APs. This feature is not supported by this version of ArubaOS.

## Enabling Capacity Alerts

Use the capacity alert feature to set managed device capacity thresholds which, when exceeded, will trigger alerts. The managed device will send a *wlsxThresholdExceeded* SNMP trap and a syslog error message when the managed device has exceeded a set percentage of the total capacity for that resource. A *wlsxThresholdCleared* SNMP trap and error message will be triggered if the resource usage drops below the threshold once again.

### In the WebUI

1. In the **Managed Network** node hierarchy, navigate to the **Configuration > System > More** page.
2. Select **Capacity Threshold**.
3. Modify the capacity percentages for any of the thresholds described in [Table 171](#).



4. Click **Submit**.
5. Click **Pending Changes**.
6. In the **Pending Changes** window, select the check box and click **Deploy changes**.

The following table describes the thresholds that can be configured with this feature.

**Table 171: Capacity Alert Thresholds**

Threshold	Description
Controlpath CPU	Set an alert threshold for controlpath CPU capacity. The <percentage> parameter is the percentage of the total controlpath CPU capacity that must be exceeded before the alert is sent. The default threshold for this parameter is 80%.
Controlpath memory	Set an alert threshold for controlpath memory consumption. The <percentage> parameter is the percentage of the total memory capacity that must be exceeded before the alert is sent. The default threshold for this parameter is 80%.
Datapath CPU	Set an alert threshold for datapath CPU capacity. The <percentage> parameter is the percentage of the total datapath CPU capacity that must be exceeded before the alert is sent. The default threshold for this parameter is 30%.
Total APs	The maximum number of APs that can be connected to a managed device is determined by that managed device's model type and installed licenses. Use this command to trigger an alert when the number of APs currently connected to the managed device exceeds a specific percentage of its total AP capacity. The default threshold for this parameter is 80%.
Total locals	Set an alert threshold for the master managed device's capacity to support branch and local managed device. A master managed device can support a combined total of 256 branch and local managed device. The <percentage> parameter is the percentage of the total master managed device capacity that must be exceeded before the alert is sent. The default threshold for this parameter is 80%.
Total tunnels	Set an alert threshold for the managed device's tunnel capacity. The <percentage> parameter is the percentage of the managed device's total tunnel capacity that must be exceeded before the alert is sent. The default threshold for this parameter is 80%.
Total users	Set an alert threshold for the managed device's user capacity. The <percentage> parameter is the percentage of the total resource capacity that must be exceeded before the alert is sent. The default threshold for this parameter is 80%.

## In the CLI

To configure this feature, access the command-line interface in config mode and issue the following commands:

```
threshold
```

### Sample Configuration

The following command configures a new alert threshold for datapath memory consumption:

```
(host) [mynode] (config) #threshold datapath-cpu 90
```

If this threshold is exceeded then subsequently drops below the 90% threshold, the managed device would send the following two syslog error messages.

```

May 14 13:13:58 nanny[1393]: <399816> <ERRS> |nanny| Resource 'Control-Path Memory' has gone
above 90% threshold, value : 93
May 14 13:16:58 nanny[1393]: <399816> <ERRS> |nanny| Resource 'Control-Path Memory' has come
below 90% threshold, value : 87

```

## Configuring Logging

This section outlines the steps required to configure logging on a managed device.

For each category or subcategory of message, you can set the logging level or severity level of the messages to be logged. [Table 172](#) summarizes these categories:

**Table 172:** *Software Modules*

Category/Subcategory	Description
Network	Network messages
all	All network messages
packet-dump	Protocol packet dump messages
mobility	Mobility messages
dhcp	DHCP messages
System	System messages
all	All system messages
configuration	Configuration messages
messages	Messages
snmp	SNMP messages
webserver	Web server messages
security	Security messages
all	All security messages
aaa	AAA messages
firewall	Firewall messages
packet-trace	Packet trace messages
mobility	Mobility messages

Category/Subcategory	Description
vpn	VPN messages
dot1x	802.1X messages
ike	IKE messages
webserver	Web server messages
Wireless	Wireless messages
all	All wireless messages
User	User messages
all	All user messages
captive-portal	Captive portal user messages
vpn	VPN messages
dot1x	802.1X messages
radius	RADIUS user messages

For each category or subcategory, you can configure a logging level. [Table 173](#) describes the logging levels in order of severity, from most to least severe.

**Table 173:** *Logging Levels*

Logging Level	Description
Emergency	Panic conditions that occur when the system becomes unusable.
Alert	Any condition requiring immediate attention and correction.
Critical	Any critical conditions such as a hard drive error.
Errors	Error conditions.
Warning	Warning messages.
Notice	Significant events of a non-critical and normal nature.
Informational	Messages of general interest to system users.
Debug	Messages containing information useful for debugging.

The default logging level for all categories is Warning. You can also configure IP address of a syslog server to which the managed device can direct these logs.

## In the WebUI

1. In the **Managed Network** node hierarchy, navigate to the **Configuration > System > Logging > Syslog Servers** page.
2. To add a logging server, click + in the **Syslog Servers** section.
3. Add the logging server to the list of logging servers. Ensure that the syslog server is enabled and configured on this host. Click **Apply**.
4. To select the types of messages you want to log, select **Logging Levels** .
5. Select the category or subcategory to be logged.
6. To select the severity level for the category or subcategory, select the level from the Logging Level drop-down list.
7. Click **Submit**.
8. Click **Pending Changes**.
9. In the **Pending Changes** window, select the check box and click **Deploy changes**.

## In the CLI

```
logging <ipaddr>  
logging level <level> <category> [subcat <subcategory>]
```

Syslog operates over UDP and is connectionless. Therefore, it is not possible for the managed device to recognize a failure of the syslog server or the network path to the syslog server. By establishing an IPsec tunnel between the managed device and the syslog server, (see [Planning a VPN Configuration](#)) it is possible to indirectly track the status of the syslog server link.

After a failure occurs, the network administrator has to manually re-synchronize log files by copying them from the managed device to the syslog server. Use the **tar logs** CLI command to create an archive of all local logs, then use the **copy** CLI command to copy this archive to an external server. Log space is limited on the managed device, and depending on how long the outage lasted some local logs may be overwritten.

## Enabling Guest Provisioning

The Guest Provisioning feature lets you manage guests who need access to your company's wireless network. This section describes how to:

- Design and configure the Guest Provisioning page – Using the WebUI, the network administrator designs and configures the Guest Provisioning page that is used to create a guest account.
- Configure a guest provisioning user – The network administrator configures one or more guest provisioning users. A guest provisioning user, such as a front desk receptionist, signs in guests at your company.
- Using the Guest Provisioning page – The Guest Provisioning page is used by the guest provisioning user to create guest accounts for people who are visiting your company.

## Configuring Guest Provisioning Page

Use the Guest Provisioning Configuration page to create the Guest Provisioning page. This configuration page consists of three tabs: Guest Fields, Page Design and Email. You configure the information on all three tabs to create a Guest Provisioning page.

- Guest Fields tab—lets you select the fields that appear on the Guest Provisioning page.

- Page Design tab—lets you specify the company banner, heading, and text and background colors that appear on the Guest Provisioning page.
- Email tab—lets you specify an email to be sent to the guest or sponsor (or both). Email messages can be sent automatically at account creation time and also may be sent manually by the administrator from the Guest Provisioning page.

## In the WebUI



You can only create and design the Guest Provisioning page in the WebUI.

This section describes how to design a Guest Provisioning page using all three tabs.

### Configuring Guest Fields

1. In the **Managed Network** node hierarchy, navigate to the **Configuration > Services > Guest Provisioning** page. The Guest Provisioning configuration page displays with the Guest Fields section on top. This section contains the following columns:
  - Internal Name—The unique identifier that is mapped to the label in the UI.
  - Label in UI—A customizable string that displays in both the main listing pane and details sheet on the Guest Provisioning page.
  - Display in Details—Fields with selected check boxes appear in the Show Details popup-window.



If the `guest_category`, `account_category`, `sponsor_category` and `optional_category` fields are not checked, their respective sections do not appear on the Guest Provisioning page.

- Display in Listing—Fields with selected check boxes appear as columns in the management user summary page.

**Figure 91** Guest Provisioning Configuration Page—Guest Fields Section

Redundancy   AirGroup   VPN   Firewall   IP Mobility <b>Guest Provisioning</b>			
Guest Fields			
Field			
INTERNAL NAME	LABEL IN UI	DISPLAY IN DETAILS	DISPLAY IN LISTING
<code>guest_category</code>	Guest	<input checked="" type="checkbox"/>	<input type="checkbox"/>
<code>guest_username</code>	Username	<input checked="" type="checkbox"/>	<input checked="" type="checkbox"/>
<code>guest_password</code>	Password	<input checked="" type="checkbox"/>	<input type="checkbox"/>
<code>guest_fullname</code>	Full name	<input checked="" type="checkbox"/>	<input checked="" type="checkbox"/>
<code>guest_company</code>	Company	<input checked="" type="checkbox"/>	<input checked="" type="checkbox"/>
<code>guest_email</code>	Email	<input checked="" type="checkbox"/>	<input type="checkbox"/>
<code>guest_phone</code>	Phone	<input checked="" type="checkbox"/>	<input type="checkbox"/>

2. Select the check box next to each field, described in [Table 174](#), that you want to appear on the Guest Provisioning page. Optionally, you can customize the label that displays in the UI.
3. Click **Preview Current Settings** in the **Guest Access** section to view what the Guest Provisioning page looks like while you are designing it.
4. Click **Submit**.
5. Click **Pending Changes**.

6. In the **Pending Changes** window, select the check box and click **Deploy changes**.



Best practices is to check the **Display in Listing** field for only the most essential fields, so that the Guest Provisioning user does not have to scroll the guest listing horizontally to see all the columns.

**Table 174:** *Guest Provisioning—Guest Field Descriptions*

Guest Field	Description
guest_category	A guest is the person who needs guest access to the company's wireless network. This is the label on the Guest Provisioning page for the guest information.
guest_username	Username for the guest.
guest_password	Password for the guest. (Must contain at least 1-6 characters and at least one digit.)
guest_fullname	Full name of the guest.
guest_company	Name of the guest's company.
guest_email	Guest's Email address.
guest_phone	Guest's phone number
comments	Optional comments about the guest's account status, meeting schedule and so on.
account_category	This is the label on the Guest Provisioning page for the account information.
creation-date	Date the account is created.
start_date	Date the guest account begins.
end_date	Date the guest account ends.
grantor	The username of the person of who created the guest account.
grantor_role	The authentication role of the grantor.
sponsor_category	A sponsor is the guest's primary contact for the visit. This is the label in the Guest Provisioning page for the sponsor information.
sponsor_username	
	Sponsor's work department
sponsor_email	Sponsor's Email address.

Guest Field	Description
optional_category	This is the label in the Guest Provisioning page for the information in the optional fields that follow.  <b>NOTE:</b> The optional_category field can be used for another person, for example a "Supervisor." You can enter username, full name, department and Email information into the optional fields. Or, you can use this category for some other purpose.
optional_field_1	optional_field_1 description
optional_field_2	optional_field_2 description
optional_field_3	optional_field_2 description
optional_field_4	optional_field_2 description

### Configuring Page Design

The Page Design section lets you specify the company banner, heading, and text and background colors that appear on the Guest Provisioning page.

1. In the **Managed Network** node hierarchy, navigate to the **Configuration > Services > Guest Provisioning** page and select the **Page Design** section.

**Figure 92** Guest Provisioning Configuration Page—Page Design Section

2. Enter the filename which contains the company banner in the **Banner** field. Or, click **Browse** to search for the filename.



Best practices is to use a logo or banner image that is 600 x 100 pixels (width x height). The WebUI does not apply the size restrictions when you upload an image file, but the image is resized to 600 x 100 pixels when it displays or is printed.

3. Enter the label for the guest listing (the one you used in the Guest Fields tab) in the **Text** field.

4. Enter the hex value for the color of the text in the **Text Color** field. The text in the header of the guest listing displays in this color.
5. Enter the hex value for the color of the background in the **Background color** field. This determines the color of the header of the guest listing.
6. Click **Preview Current Settings** in the **Guest Access** section to view what the Guest Provisioning page looks like while you are designing it.
7. Click **Submit**.
8. Click **Pending Changes**.
9. In the **Pending Changes** window, select the check box and click **Deploy changes**.

### Configuring Email Messages

You can specify an email to be sent to the guest or sponsor (or both). Email messages can be sent automatically at account creation time or sent manually by the network administrator or guest provisioning user from the Guest Provisioning page at any time.

1. Specify the SMTP server and port that processes the guest provisioning (also known as guest access) email. You can complete this step using the WebUI or CLI commands:
  - [Configuring SMTP Server and Port in WebUI on page 792](#)
  - [Configuring SMTP server and port in CLI on page 792](#)
2. Create the email messages. Complete this step using the WebUI:  
[Creating Email Messages in the WebUI on page 792](#)

### Configuring SMTP Server and Port in WebUI

1. In the **Managed Network** node hierarchy, navigate to the **Configuration > System > More** page.
2. Click the **SMTP** section in the bottom of the page.
3. Enter the IP address of the SMTP server to which the managed device sends the guest provisioning email in the **IP Address of SMTP server** field.
4. Enter the number of the port through which the guest provisioning email passes in the **Port** field.
5. Click **Submit**.
6. Click **Pending Changes**.
7. In the **Pending Changes** window, select the required check box and click **Deploy changes**.

### Configuring SMTP server and port in CLI

The following command creates a guest-access email and sends guest user email through SMTP server IP address 1.1.1.1 on port 25.

```
(host) [md] (config) #guest-access-email
(host) [md] (Guest-access Email) #smtp-port 25
(host) [md] (Guest-access Email) #smtp-server 1.1.1.1
```

### Creating Email Messages in the WebUI

After you configured the SMTP server and port, follow these steps:

1. Navigate to the **Configuration > Services > Guest Provisioning** page and select the **Guest Email** or **Sponsor Email** section.



**Figure 93** Guest Provisioning Configuration Page—Email Section

Redundancy AirGroup VPN Firewall IP Mobility **Guest Provisioning**

Guest Fields

Page Design

Guest Access

Guest Email

**Subject:** Guest account informati

**From:** guest\_admin@yourcom

**Body:** A guest account has been created for your use. The username, password and valid dates for the account

**Send automatically at account creation time:**

2. To create a message for a guest or sponsor, customize the text in the **Subject**, **From**, and **Body** fields as needed for both the **Guest message** and **Sponsor message**.
3. Optionally, select the **Send automatically at account creation time** check box when you want an email message to be sent to the guest and/or sponsor alerting them that a guest account has just been created.



Regardless of whether you select this option, the person responsible for managing the **Guest Provisioning** page may choose to send this email message manually at any time.

[Figure 94](#) shows a sample email message that is sent to the guest after the guest account is created.

**Figure 94** Sample Guest Account Email – Sent to Sponsor

```
Sent: Monday, February 09, 2009 12:59 PM
To: John Smith
Subject: Guest account information

A guest account has been created for your use. The username, password and
valid dates for the account are given below.
=====
Username:  guest3518444
Password:  hqtehjc1936850
Guest Name:
Guest Company:  MyCompany
Guest Email:  JSmith@MyCompany.com
Guest Phone:
Sponsor Email:  DJones@AcmeCompany.com
Start Date:  Mon Feb  9 18:46:00 2009
Expiration Date:  Mon Feb  9 19:46:00 2009
```

4. To save changes, click **Apply**.

## Configuring Guest Provisioning User

The guest provisioning user has access to the Guest Provisioning Page (GPP) to create guest accounts within your company. The guest provisioning user is usually a person at the front desk who greets guests and creates guest accounts. Depending upon your needs, there are three ways to configure and authenticate a guest provisioning user:

- Username and Password authentication — Allows you to configure a user in a guest provisioning role.
- Smart Card authentication
  - Static authentication — Uses a configured certificate name and serial number to derive the user role. This authentication process uses a previously configured certificate name and serial number to derive the user role. This method does not use an external authentication server.
  - Authentication server — Uses an external authentication server to derive the management role. This is helpful if there is a large number of users who need to be deployed as guest provisioning users.

You can use the WebUI or CLI to create a Guest Provisioning user.

### In the WebUI

This section describes how to configure a guest provisioning user. All three methods are described.

#### Username and Password Authentication Method

1. In the **Managed Network** node hierarchy, navigate to the **Configuration > System > Admin** page.
2. Select **Enable Local Authentication** as needed.
3. In the Management Users section, click +.
4. In the **Username** field, enter the name of the user who you want to configure as a guest provisioning user.
5. In the **Password** and **Confirm Password** fields, enter the user's password and reconfirm it.
6. From the **Role** drop-down list, select **guest-provisioning**.
7. Click **Submit**.
8. Click **Pending Changes**.
9. In the **Pending Changes** window, select the check box and click **Deploy changes**.

#### Static Authentication Method



---

Before using this method, make sure that the correct CA certificate is uploaded to the managed device.

---

1. In the **Managed Network** node hierarchy, navigate to the **Configuration > System > Administration** page.
2. In the Management Users section, click +.
3. In the **New User** section, select **show users with certificate authentication**.
4. Click +.
5. Make sure that the **Use external authentication server to authenticate** check box is unchecked.
6. In the **Username** field, enter the name of the user who you want to configure as a guest provisioning user.
7. In the **Role** field, select **guest-provisioning** from the drop-down list.
8. Select the CA certificate you want to use from the **Trusted CA Certificate Name** drop-down list.
9. Enter client certificate serial number in the **Client Certificate Serial No.** field.
10. Click **Apply**.

## Smart Card Authentication Method

1. In the **Managed Network** node hierarchy, navigate to the **Configuration > System > Admin** page.
2. Expand **Admin Authentication Options**.
3. Under **Admin Authentication Options**, select **guest-provisioning** from the **Default role** drop-down list.
4. Select the **Enabled** from the **Enable** drop-down list.
5. Select the server group from the **Server Group** drop-down list.
6. Click **Submit**.
7. Under **WebUI Authentication**, select **Enabled** for **Client Certificate**.
8. Click **Submit**.
9. Under **Management Users**, click **Show users with certificate authentication**.
10. Click **+**.
11. Select **WebUI Certificate** and **Use external authentication server to authenticate**.
12. Select the trusted CA certificate from the **Trusted CA Certificated Name** drop-down list.
13. Click **Submit**.
14. Click **Pending Changes**.
15. In the **Pending Changes** window, select the required check boxes and click **Deploy changes**.

## In the CLI

### Username and Password Method

This example creates a user named Alex and assigns her the role of guest provisioning.

```
(host) [md] (config)# mgmt-user Alex guest-provisioning
```

### Static Authentication Method

This example uses the CA certificate **mycertificate** with the serial number 1234 to authenticate user Laura in the guest provisioning role.

```
(host) [md] (config)# mgmt-user webui-cacert mycertificate serial 1234 Laura guest-provisioning
```

### Smart Card Authentication Method

This example shows that using previously configured certificate (1234), authentication and authorization are automatically configured using an authentication server.

```
(host) [md] (config) #web-server profile
(host) [md] (Web Server Configuration) #mgmt-auth username/password certificate
(host) [md] (Web Server Configuration) #!
(host) [md] (config) #mgmt-user webui-cacert <certificate_name>
(host) [md] (config) #aaa authentication mgmt
(host) [md] (config) #server-group "internal"
(host) [md] (config) #mgmt-user webui-cacert default
(host) [md] (config) #mgmt-user webui-cacert 1234
```

## Customizing Guest Access Pass

In the WebUI, you can customize the pop-up window that displays the guest account information. You may want to do this before the Guest Provisioning user creates guest accounts.

1. In the **Managed Network** node hierarchy, navigate to the **Configuration > Services > Guest Provisioning** page and click the **Guest Access** section.
2. Click **Browse** to insert a logo or other banner information on the window.



Best practices is to use a logo or banner image that is 600 x 100 pixels (width x height). The WebUI does not apply the size restrictions when you upload an image file, but the image is resized to 600 x 100 pixels when it displays or is printed.

3. You can enter text for the Policy portion of the window.
4. Click **Submit** to save your changes. Click **Preview Pass** to preview the window. (See [Figure 95.](#))

**Figure 95** Customized Guest Account Information Window



## Creating Guest Accounts

After the Guest Provisioning user is created, that person can log in to the managed device using the preconfigured username and password. The Guest Provisioning page displays. (See [Figure 97.](#)) This is a sample page as the fields may differ based on how the network administrator designed the page.

**Figure 96** Creating a Guest Account—Guest Provisioning Page

Guests				
<input type="checkbox"/> Show details				
New Import Delete Print Edit				
Guest	Account			
Username	Full name	Company	Start	End
00:0b:86:66:2a:f9				
Laura	Laura R.	MyCompany	Aug 19, 2010 10:57 AM	Aug 19, 2010 06:57 PM
guest-8187776	Holden C.	Catcher Inc.	Aug 19, 2010 10:58 AM	Aug 19, 2010 06:58 PM



If you do not want multiple guest users to share the same guest account concurrently, navigate to the Captive Portal Authentication and select the “Allow only one active user session” option. If a guest user authenticates successfully but the managed device detects there is already a guest session with the same guest username, the second login is rejected.

## Guest Provisioning User Tasks

The Guest Provisioning user creates guest accounts by filling in information on the Guest Provisioning page. Tasks include creating, editing, manually sending email, enabling, printing, disabling and deleting guest accounts. The Guest Provisioning user can also manually send emails to either the guest or sponsor.

To create a new guest account, the Guest Provisioning user clicks **New** to display the New Guest window. (See [Figure 97](#).) After filling in information into the fields, click **Create**. The guest account now displays on the Guest Provisioning page.

If you manually configure the user name and password, note the following:

- User name entries support alphanumeric characters, however the percent sign (%) and trailing the back slash are not allowed.
- Passwords must have a minimum of six characters. You can use special characters for the password.
- Click on the **Account Start** and **End** fields to change the account start and end times. The default account start to end time setting is eight hours.

**Figure 97** *Creating a Guest Account—New Guest Window*

Guests		
Guest	Company	Account
Username		Start
Laura	ABC Company	Mar 19, 2009 12:32 F
guest9015890		Mar 19, 2009 12:36 F

**New Guest**

**Guest**

Username:\* April Generate

Password:\* ..... Generate

Retype:\* .....

Full name: April P

Company:

Email:

Phone:

Comments:

**Account**

Start: Mar 19, 2009 12:36 PM

End: Mar 19, 2009 01:36 PM

**Sponsor**

Username: Paula

Full name:

Email:

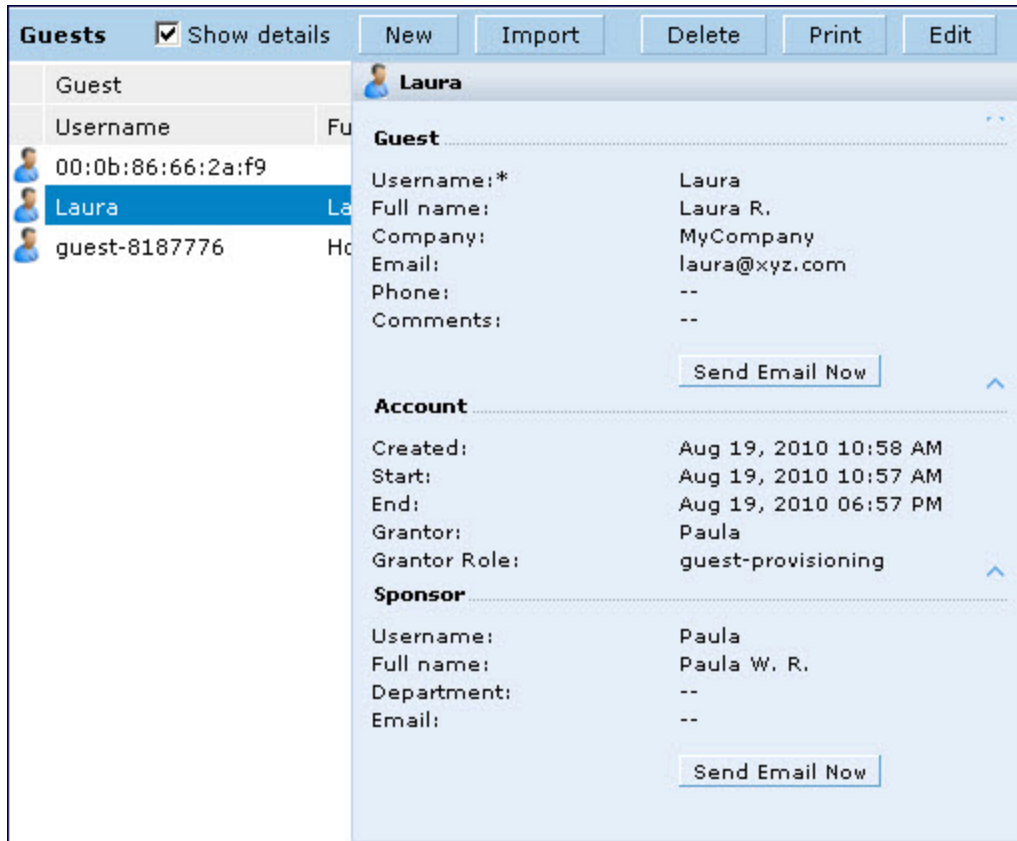
**Supervisor**

Supervisor name:

Create Create & Print Cancel

To see details about an existing user account, highlight an existing account and select the **Show Details** check box. The Show Details popup-window displays. (See [Figure 98](#).) The Guest Provisioning user can send out Email from this window to either the guest or the sponsor. When you send an email from the Details pop-up window, a pop-up message confirming that the email was successfully processed displays

**Figure 98** *Creating a Guest Account—Show Details Pop-up Window*



## Importing Multiple Guest Entries

The Guest Provisioning user can manually create individual guest entries, as previously described, or import multiple guest entries into the database from a CSV file. This is useful and more efficient if you want to enter multiple guest entries at once. To import multiple guest entries, you need to:

1. Create a CSV file that contains the guest entries
2. Import the CSV file into the database

## Creating Multiple Guest Entries in CSV File

Create a CSV file that contains multiple guest entries. Each field in an entry needs to be separated by a comma and each entry needs to end with a carriage return. The order of the fields is:

- Guest's first name (required)
- Guest's last name (required)
- Guest's email address (optional)
- Guest's phone number (optional)
- Guest's user ID (optional)
- Guest's password (optional)
- Sponsor's first name (optional)
- Sponsor's last name (optional)
- Sponsor's email address (optional)

See [Figure 99](#) for an example of how guest entries need to be formatted in a CSV file.

**Figure 99** *CVS File Format—Guest Entries Information*

```
Gene,Phineas,gphineas@arubanetworks.com,(415)555-1212,guest-  
gwang,abcdefg,Jane,Smith,jsmith@arubanetworks.com  
Caulfield,Holder  
John,Galt,,,guest1110
```

Note the following limitations when creating guest entries in a CVS file:

- None of the field values can have a comma
- There is no format checking on field. Only the **local-userdb-guest** CLI command will validate proper format.
- Any extra columns, beyond the 9th column, are discarded.
- The WebUI only supports characters that the CLI supports.
- If a guest's user ID is not provided, then it is automatically generated based on the numeric suffix in the Import Guest List window. See [Figure 100](#).
- We recommend a maximum of 250 entries per CSV file.

### Importing CSV File into Database

To import a CSV file that contains multiple guest entries, the Guest Provisioning user must follow these steps:

1. Log in to the WebUI using the username and password assigned to the Guest Provisioning user.
2. Click on **Import**. The **Import Guest List** pop-up window displays. See [Figure 100](#).

**Figure 100** Importing a CSV file that contains Guest Entries

**Import Guest List**

You can import a .csv file with a list of up to 250 guests.

<b>Required fields:</b>	<b>Optional fields:</b>
Guest First Name	Guest Email
Guest Last Name	Guest Phone Number
	Guest Userid
	Guest Password
	Sponsor First Name
	Sponsor Last Name
	Sponsor E-Mail

UsersIDs .....

If the file does not include the Guest UserID field, it will be auto-generated using the suffix. For example, guest0, guest1,...

Suffix for auto-generated field:

File to Import .....

File:

File has column headers    [View sample file](#)

Account Duration .....

Start:

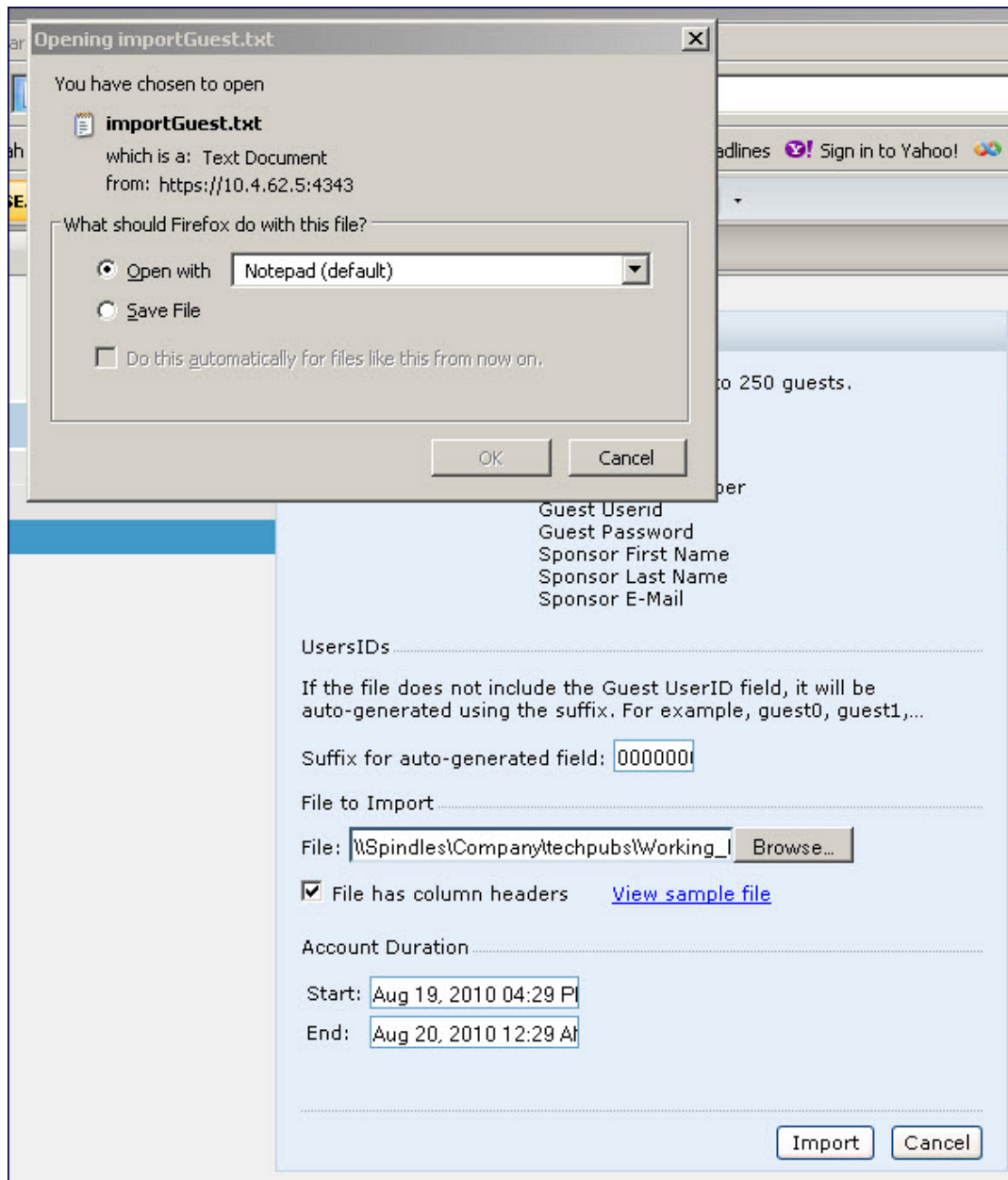
End:

3. Click **Browse** to locate for the CSV file you want to import.
4. Click **Import**. A window displays that lets you open CSV file in text format. (See [Figure 101.](#)) Open the text file to see a summary of the number of users and error messages if users are not imported.

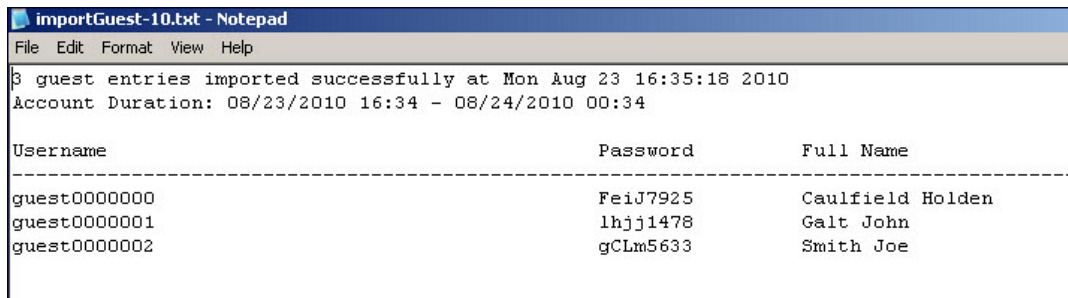


**Figure 101** *Displaying the Guest Entries Log File*



5. Click **Import**. A window displays that lets you open CSV file in text format. (See [Figure 101](#).)
6. Open the text file. (See [Figure 102](#).) Note that because no user ID is entered in the CSV file, a guest ID (username) is automatically generated based on the default value in the **Suffix for auto-generated** field. Make changes or corrections to the guest entry information in text file. A user can also change the start time and end time from this window. Save and exit the file.

**Figure 102** Viewing and Editing Guest Entries in the Log File

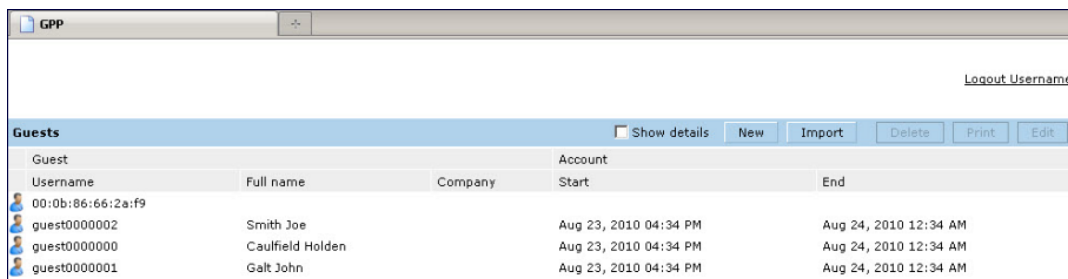


```
importGuest-10.txt - Notepad
File Edit Format View Help
3 guest entries imported successfully at Mon Aug 23 16:35:18 2010
Account Duration: 08/23/2010 16:34 - 08/24/2010 00:34

Username                                Password                                Full Name
-----
guest0000000                             FeiJ7925                               Caulfield Holden
guest00000001                             lhjj1478                               Galt John
guest00000002                             gCLm5633                               Smith Joe
```

7. Click **Cancel** to close the **Import Guest List** window. Guest entries are now displayed in the Guest Provisioning page.

**Figure 103** Viewing Multiple Imported Guest Entries—Guest Provisioning Page



Guests				
Guest	Account		Account	
Username	Full name	Company	Start	End
00:0b:86:66:2a:f9				
guest00000002	Smith Joe		Aug 23, 2010 04:34 PM	Aug 24, 2010 12:34 AM
guest00000000	Caulfield Holden		Aug 23, 2010 04:34 PM	Aug 24, 2010 12:34 AM
guest00000001	Galt John		Aug 23, 2010 04:34 PM	Aug 24, 2010 12:34 AM

### Printing Guest Account Information

To print guest account information:

1. Highlight the guest account you want to print and click **Print**. The **Print info for guest** window displays.
2. Click **Print password** if you want to print the guest password on the badge. Then enter or generate a new password for the guest. This modifies the existing guest password. (See [Figure 104](#).)
3. Optionally, click **Print policy text** if you want your company policy text to appear on the print out.
4. Click **Show preview** to view the information before it is printed.
5. Click **Print** to print the guest account information.

**Figure 104** *Printing Guest Account Information*

The screenshot shows a web interface with a 'Guests' table and a 'Print info for guest Laura' dialog box. The table lists guests with columns for Username, Company, and Start. The dialog box has options to 'Print password' and 'Print policy text', with password fields and a 'Generate' button. A preview window shows a document header with 'My Company' logo and 'Guest Account Information for' followed by details for Laura: Username: Laura, Password: vsougy5035237, Company: (blank), Start: Mar 19, 2009 02:19 PM, End: Mar 19, 2009 03:19 PM, and a link to 'Acceptable User Policy'. Buttons for 'Print' and 'Cancel' are at the bottom.

Guest	Account	
Username	Company	Start
Laura		Mar 19, 2009 02:19 PM
guest2027215		Mar 19, 2009 02:19 PM
guest2235409		Mar 19, 2009 02:19 PM
April		Mar 19, 2009 02:20 PM

## Optional Configurations

This section describes guest provisioning options that the administrator can configure.



---

These options are not configurable by the guest provisioning user.

---

### Restricting one Captive Portal Session for each Guest

You can restrict one captive portal session for each guest. When a new captive portal request is received and passes authentication, all users are checked and compared with user names. If a user with the same name already exists and this option is enabled, the second login is denied.



---

If a guest logs in from one system (and does not log out) and tries to log in again from another system, that guest has to wait for the initial session to expire.

---

1. In the **Managed Network** node hierarchy, navigate to the **Configuration > System > Profiles** page.
2. Select **Wireless LAN**.
3. Under **Wireless LAN**, select and open **Captive Portal Authentication**.
4. Add a new or select an existing profile.
5. Select the **Allow only one active user session** check box.
6. Click **Submit**.
7. Click **Pending Changes**.
8. In the **Pending Changes** window, select the check box and click **Deploy changes**.

### Using the CLI to restrict one Captive Portal session for each guest

```
(host) [md] (config) #aaa authentication captive-portal <> single-session
```

## Setting Maximum Time for Guest Accounts

You can set the maximum expiration time (in minutes) for guest accounts. If the guest-provisioning user attempt to add a guest account that expires beyond this time period, an error message is displayed and the guest account is created with the maximum time you configured.



---

If you set the maximum expiration time, it applies to all users in the internal database whether they are guests or not.

---

### Using WebUI to set maximum time for guest accounts

1. In the **Managed Network** node hierarchy, navigate to the **Configuration > Security > Authentication** page.
2. Select **Internal DB**.
3. Under Internal DB Maintenance, enter a value in **Maximum Expiration**.
4. Click **Submit**.
5. Click **Pending Changes**.
6. In the **Pending Changes** window, select the check box and click **Deploy changes**.

### Using CLI to set maximum time for guest accounts

```
(host) [md] (config) #local-userdb maximum-expiration <minutes>
```

## Managing Files on Managed Device

You can transfer the following types of files between the managed device and an external server or host:

- ArubaOS image file
- A specified file in the managed device's flash file system, or a compressed archive file that contains the entire content of the flash file system.



---

You back up the entire content of the flash file system to a compressed archive file, which you can then copy from the flash system to another destination.

---

- Configuration file, either the active running configuration or a startup configuration.
- Log files.

You can use the following protocols to copy files to or from a managed device:

- File Transfer Protocol (FTP): Standard TCP/IP protocol for exchanging files between computers.
- Trivial File Transfer Protocol (TFTP): Software protocol that does not require user authentication and is simpler to implement and use than FTP.
- Secure Copy (SCP): Protocol for secure transfer of files between computers that relies on the underlying Secure Shell (SSH) protocol to provide authentication and security.



---

You can use SCP only for transferring image files to or from the managed device, or transferring files between the flash file system on the managed device and a remote host. The SCP server or remote host must support SSH version 2 protocol.

---

The following table lists the parameters that you configure to copy files to or from a managed device.

**Table 175: File Transfer Configuration Parameters**

Server Type	Configuration
Trivial File Transfer Protocol (TFTP)	<ul style="list-style-type: none"> <li>• tftphost - tftp host IPv4 / IPv6 address</li> <li>• filename - absolute path of filename</li> <li>• flash: - copy to the flash file system</li> <li>• destination: - destination file name</li> <li>• system: - system partition</li> <li>• partition - partition 0 / partition 1</li> </ul>
File Transfer Protocol (FTP)	<ul style="list-style-type: none"> <li>• ftphost - ftp server host name or IPv4/IPv6 address</li> <li>• username - user name to log into server</li> <li>• filename - absolute path of filename</li> <li>• system: - system partition</li> <li>• partition - partition 0 / partition 1</li> </ul>
Secure Copy (SCP) You must use the CLI to transfer files with SCP.	<ul style="list-style-type: none"> <li>• scphost - scp host of IPv4 / IPv6 address</li> <li>• username - user name to secure to log into the server</li> <li>• filename - absolute path of filename (otherwise, SCP searches for the file relative to the user's home directory)</li> <li>• flash: - copy to the flash file system</li> <li>• destfilename: - destination file name</li> <li>• system: - system partition</li> <li>• partition - partition 0 / partition 1</li> </ul>

For example, you can copy an ArubaOS image file from an SCP server to a system partition on a managed device or copy the startup configuration on a managed device to a file on a TFTP server, You can also store the contents of a managed device's flash file system to an archive file which you can then copy to an FTP server. You can use SCP to securely download system image files from a remote host to the managed device or securely transfer a configuration file from flash to a remote host.

## Transferring ArubaOS Image Files

You can download an ArubaOS image file onto a managed device from a TFTP, FTP, or SCP server. In addition, the WebUI allows you to upload an ArubaOS image file from the local PC on which you are running the browser.

When you transfer an ArubaOS image file to a managed device, you must specify the system partition to which the file is copied. The WebUI shows the current content of the system partitions on the managed device. You have the option of rebooting the managed device with the transferred image file.

### In the WebUI

1. In the Mobility Master node hierarchy, navigate to the **Maintenance > Upgrade > Master Configuration** page.
2. Select TFTP, FTP, SCP, or Upload Local File.
3. Enter or select the appropriate values for the file transfer method.
4. Select the system partition to which the image file is copied.

- Specify whether the managed device is to be rebooted after the image file is transferred, and whether the current configuration is saved before the managed device is rebooted.
- Click **Upgrade**.

### In the CLI

```
copy tftp: <tftphost> <filename> system: partition [0|1]}
copy ftp: <ftphost> <user> <filename> system: partition {0|1}
copy scp: <scphost> <username> <filename> system: partition [0|1]
```

## Backing Up and Restoring Flash File System

You can store the entire content of the flash file system on a managed device to a compressed archive file. You can then copy the archive file to an external server for backup purposes. If necessary, you can restore the backup file from the server to the flash file system.

### Backup Flash File System in the WebUI

- In the Mobility Master node hierarchy, navigate to the **Maintenance > Backup Flash** page.
- Click **Create Backup** to back up the contents of the flash system to the *flashbackup.tar.gz* file.
- Click **Copy Backup** to enter the Copy Files page where you can select the destination server for the file.
- Click **Submit**.
- Click **Pending Changes**.
- In the **Pending Changes** window, select the check box and click **Deploy changes**.

### Backup Flash File System in the CLI

```
backup flash
copy flash: flashbackup.tar.gz tftp: <tftphost> <destfilename>
copy flash: flashbackup.tar.gz scp: <scphost> <username> <destfilename>
```

### Restore Flash File System in the WebUI

- In the **Mobility Master** node hierarchy, navigate to the **Maintenance > Copy Files** page.
  - For Source Selection, specify the server to which the *flashbackup.tar.gz* file was previously copied.
  - For Destination Selection, select Flash File System.
- Click **Submit**.
- Click **Pending Changes**.
- In the **Pending Changes** window, select the check box and click **Deploy changes**.
- In the **Mobility Master** node hierarchy, navigate to the **Maintenance > Restore Flash** page.
- Click **Restore** to restore the *flashbackup.tar.gz* file to the flash file system.
- In the **Mobility Master** node hierarchy, navigate to the **Maintenance > Upgrade > Reboot** page.
- Click **Continue** to reboot.

### Restore Flash File System in the CLI

```
copy tftp: <tftphost> <srcfilename> flash: flashbackup.tar.gz
copy scp: <scphost> <username> <srcfilename> flash: flashbackup.tar.gz
restore flash
```

## Copying Log Files

You can store log files into a compressed archive file which you can then copy to an external TFTP or SCP server. The WebUI allows you to copy the log files to a WinZip folder which you can display or save on your local PC.

## In the WebUI

1. In the **Mobility Master** node hierarchy, navigate to the **Maintenance > Copy Logs** page.
2. For Destination, specify the TFTP or FTP server to which log files are copied.
3. Select Download Logs to download the log files into a WinZip file on your local PC,
4. Click **Submit**.
5. Click **Pending Changes**.
6. In the **Pending Changes** window, select the check box and click **Deploy changes**.

## In the CLI

```
tar logs
copy flash: logs.tar tftp: <tftphost> <destfilename>
copy flash: logs.tar scp: <scphost> <username> <destfilename>
```

## Copying Other Files

The flash file system contains the following configuration files:

- startup-config: Contains the configuration options that are used the next time the managed device is rebooted. It contains all options saved by clicking the **Submit** button in the WebUI or by entering the write memory CLI command. You can copy this file to a different file in the flash file system or to a TFTP server.
- running-config: Contains the current configuration, including changes which have yet to be saved. You can copy this file to a different file in the flash file system, to the startup-config file, or to a TFTP or FTP server.

You can copy a file in the flash file system or a configuration file between the managed device and an external server.

## In the WebUI

1. In the **Mobility Master** node hierarchy, navigate to the **Maintenance > Copy Files** page.
2. Select the source where the file or image exists.
3. Select the destination to where the file or image is to be copied.
4. Click **Submit**.
5. Click **Pending Changes**.
6. In the **Pending Changes** window, select the check box and click **Deploy changes**.

## In the CLI

```
copy startup-config flash: <filename>
copy startup-config tftp: <tftphost> <filename>
copy running-config flash: <filename>
copy running-config ftp: <ftphost> <user> <filename> [<remote-dir>]
copy running-config startup-config
copy running-config tftp: <tftphost> <filename>
```

## Setting System Clock

You can set the clock on a managed device manually or by configuring the managed device to use a Network Time Protocol (NTP) server to synchronize its system clock with a central time source.

### Manually Setting Clock

You can use either the WebUI or CLI to manually set the time on the managed device's clock.

## In the WebUI

1. In the **Managed Network** node hierarchy, navigate to the **Configuration > System > General** page and click the **Clock** section.
2. For the **Time**, select whether to **Get time from NTP server** or **Use current system time**.
3. For **Time Zone**, select the offset from Greenwich Mean Time (GMT) and select the name of the time zone.
4. To adjust the clock for daylight savings time, click **Enabled** under Summer Time. Additional fields appear that allow you to set the offset from UTC, and the start and end recurrences.
5. Click **Submit**.
6. Click **Pending Changes**.
7. In the **Pending Changes** window, select the check box and click **Deploy changes**.

## In the CLI

To set the date and time, enter the following command in privileged mode:

```
clock set <year> <month> <date> <hour> <minutes> <seconds>
```

To set the time zone and daylight savings time adjustment, enter the following commands in configure mode:

```
clock timezone <WORD> <-23 - 23>
clock summer-time <zone> [recurring]
  <1-4> <start day> <start month> <hh:mm>
  first <start day> <start month> <hh:mm>
  last <start day> <start month> <hh:mm>
  <1-4> <end day> <end month> <hh:mm>
  first <end day> <end month> <hh:mm>
  last <end day> <end month> <hh:mm>
  [<-23 - 23>]
```

## Clock Synchronization

You can use NTP to synchronize the managed device to a central time source. Configure the managed device to set its system clock using NTP by configuring one or more NTP servers.

For each NTP server, you can optionally specify the NTP iburst mode for faster clock synchronization. The iburst mode sends up ten queries within the first minute to the NTP server. (When iburst mode is not enabled, only one query is sent within the first minute to the NTP server.) After the first minute, the iburst mode typically synchronizes the clock so that queries need to be sent at intervals of 64 seconds or more.



---

The iburst mode is a configurable option and not the default behavior for the managed device, as this option is considered “aggressive” by some public NTP servers. If an NTP server is unresponsive, the iburst mode continues to send frequent queries until the server responds and time synchronization starts.

---

## In the WebUI

1. In the **Managed Network** node hierarchy, navigate to the **Configuration > System > General > Clock** page.
2. Under NTP Servers, click **Add**.
3. Enter the IP address of the NTP server.
4. Select (check) the **Burst mode**, if desired.
5. Click **Submit**.
6. Click **Pending Changes**.
7. In the **Pending Changes** window, select the check box and click **Deploy changes**.



## In the CLI

```
ntp server ipaddr [iburst]
```

## Configuring NTP Authentication

The Network Time Protocol adds security to an NTP client by authenticating the server before synchronizing the local clock. NTP authentication works by using a symmetric key which is configured by the user. The secret key is shared by both the managed device and an external NTP server. This helps identify secure servers from fraudulent servers.

## In the CLI

This example enables NTP authentication, add authentication secret keys into the database, and specifies a subset of keys which are trusted. It also enables the `iburst` option.

```
(host) [md] (config) #ntp authenticate
(host) [md] (config) #ntp authentication-key <key-id> md5 <key-secret>
(host) [md] (config) #ntp trusted-key <key-id>
(host) [md] (config) #ntp server <ipaddr> <iburst> <key>
(host) [md] (config) #ntp server <server IP> <iburst key> <key>
```

## Timestamps in CLI Output

The timestamp feature can include a timestamp in the output of each `show` command issued in the command-line interface, indicating the date and time the command was issued. Note that the output of **show clock** and **show log** do not include timestamps, even when this feature is enabled.

To enable this feature, access the command-line interface in config mode and issue the command **clock append**.

```
(host) [md] (config) #clock append
```

## ClearPass Policy Manager Profiling with IF-MAP

This feature is used in conjunction with ClearPass Policy Manager. It sends HTTP User Agent Strings and mDNS broadcast information to ClearPass Policy Manager so that it can make more accurate decisions about what types of devices are connecting to the network.

## In the WebUI

To enable and configure this feature:

1. In the **Managed Network** node hierarchy, navigate to **Configuration > System > Profiles > All Profiles > Other Profiles**.
2. Click the **CPPM IF-MAP** profile.
3. Configure this profile according to the following parameters:

**Table 176:** ClearPass Policy Manager IF-Map Configuration Parameters

Parameter	Description
CPPM IF-Map Interface	Enables the feature
Host IP address	IP address or hostname of the ClearPass Policy Manager IF-MAP server
Username	Username for the user who performs actions on the ClearPass Policy Manager IF-MAP server. Range must be between 1-255 bytes in length.
Password	Password of the user who performs actions on the ClearPass Policy Manager IF-MAP server. Range between 6-100 bytes in length.

## In the CLI

To configure this feature using the CLI:

```
(host) [md] (config) #ifmap
(host) [md] (config) #ifmap cppm
(host) [md] (CPPM IF-MAP Profile) #server host <host>
(host) [md] (CPPM IF-MAP Profile) #port <port>
(host) [md] (CPPM IF-MAP Profile) #passwd <psswd>
(host) [md] (CPPM IF-MAP Profile) #enable
```

This **show ifmap cppm** command shows if the CPPM interface is enable and the ClearPass Policy Manager server IP address, username and password.

```
(host) [md] (CPPM IF-MAP Profile) #show ifmap cppm
CPPM IF-MAP Profile
-----
Parameter          Value
-----
CPPM IF-MAP Interface  Enabled
CPPM IF-MAP Server    10.4.191.32:443 admin/*****
```

This show command shows if state of all enabled ClearPass Policy Manager servers.

```
(host) [md] (CPPM IF-MAP Profile) #show ifmap state cppm
CPPM IF-MAP Connection State [Interface: Enabled]
-----
Server              State
-----
10.4.191.32:443    UP
```

## Whitelist Synchronization

ArubaOS allows managed devices to synchronize their remote AP whitelists with the Aruba Activate cloud-based services. When you configure Activate whitelist synchronization, the managed device will securely contact the Activate server and download the contents of the whitelist on the Activate server to the whitelist on the managed device. The managed device and the Activate server must have layer-3 connectivity to communicate.

By default, this feature will both add new remote AP entries to the managed device whitelist and delete any obsolete entries on the managed device whitelist that were not on the Activate server whitelist. Select the add-only option to allow this feature to add or modify entries, but not delete any existing entries.

## In the CLI

The following example enables the Activate whitelist service on the managed device. The **add-only** parameter allows only the addition of entries to the Activate remote AP whitelist database. This parameter is enabled by default. If this setting is disabled, the `activate-whitelist-download` command can both add and remove entries from the Activate database.

```
(host) [md] (config)# activate-service-whitelist
(host) [md] (activate-service-whitelist) #username user2 password pA$$w0rd whitelist-enable
(host) [md] (activate-service-whitelist) #add-only
```

The following command is available in enable mode, and prompts the managed device to synchronize its remote AP whitelist with the associated whitelist on the Activate server:

```
(host) [md] (config) #activate whitelist download
```

## Downloadable Regulatory Table

The downloadable regulatory table feature allows for the update of country domain options without upgrading the ArubaOS software version. A separate file, called the Regulatory-Cert, containing AP regulatory information will be released periodically on the customer support site. The Regulatory-Cert file can then be uploaded to a managed device and pushed to deployed APs.

The Regulatory-Cert includes the following information for each AP:

- All countries supported in the current release of ArubaOS (not just United States or Rest of World or any subset of countries)
- Allowed channels for each country
- Max EIRP for each channel and each country in the allowed list. The max values are specified for each PHY-type at which the AP is allowed to transmit on. The classified PHY-types are
  - 802.11 OFDM rates (802.11 a/g mode)
  - 802.11 b rates (CCK rates)
  - 802.11 n HT20 and 802.11 ac VHT20 rates (MCS0-7)
  - 802.11 n HT20 and 802.11 ac VHT40(MCS0-7)
  - 802.11 ac VHT80 rates
- DFS functionality for each channel and each country in the allowed list

## Important Points to Remember

- When a Regulatory-Cert is activated, the new file is checked against the default file built into ArubaOS. If the file is of a newer version, the activation is allowed. If the file is of a lower version, then the activation is not completed. The managed device's CLI displays the following message upon failure:

```
(host0) #ap regulatory activate reg-data-1.0_00002.txt
Failed to activate regulatory file reg-data-1.0_00002.txt. File Version should be greater
than 1.0_43859
```

- APs do not rebootstrap or reboot on activation.
- If there is change in channel list or power level, APs will change the channel/power level. Impact is same as that of ARM channel/power change in that case.
- Clients are not disconnected upon regulatory file activation. Max latency impact during activation (with no channel changes) is less than 1s (applies to power change too).
- With channel change, the impact is similar to ARM channel change (depends on client behavior and if CSA is enabled or not).
- If support for the AP (Country) is added, the AP will move from AM to AP mode (if the AP is configured in AP mode of operation).

## Copying the Regulatory-Cert

You can use the following protocols to copy the regulatory file to a managed device:

- FTP
- TFTP
- SCP

Additionally, regulatory files saved to a USB drive can be uploaded to a managed device equipped with a USB port.

You can copy the Regulatory-Cert to the managed device using the WebUI or CLI.

### In the WebUI

1. In the **Managed Network** node hierarchy, navigate to the **Maintenance > File > Copy Files** page.
2. Select the source (TFTP, FTP, SCP, or USB) where the file exists.
3. The managed device WebUI will automatically select **Flash File System** under the **Destination Selection** menu.
4. Click **Submit**.
5. Click **Pending Changes**.
6. In the **Pending Changes** window, select the check box and click **Deploy changes**.

### In the CLI

Use one of the following **copy** commands to download the regulatory file to the managed device:

```
copy
  ftp: <ftphost> <user> <filename>
  scp: <scphost> <username> <filename> flash: <destfilename>
  tftp: <tftphost> <filename> flash: <destfilename>
  usb: partition <partition-number> <filename> flash: <destfilename>
```

To view the current regulatory and the content of the file, use the following commands:

```
show ap regulatory
show ap allowed-channels country-code <country-code> ap-type <ap-type>
show ap allowed-max-eirp ap-name <ap-name> country-code <country-code>
show ap debug received-reg-table ap-name <ap-name>
```

## Activating the Regulatory-Cert

Once the Regulatory-Cert has been added to the managed device, the new regulatory information must be activated and pushed to the APs.

### In the WebUI

To activate a specific regulatory file using the WebUI:

1. In the **Managed Network** node hierarchy, navigate to **Maintenance > File > Regulatory Files**.
2. Select a regulatory file from the **File List**.
3. Click **Activate**.

### In the CLI

To activate a specific regulatory file loaded on the managed device, use the following command:

```
ap regulatory activate <filename>
```

To return to the factory default regulatory-cert, use the following command:

```
ap regulatory reset
```

In a master-local-standby deployment, the file syncing profile can be enabled to ensure that the regulatory-cert that is stored on the master is shared with its subordinate managed devices. File syncing is enabled by default, with a default sync time of 30 minutes. The sync time can be set between 30 to 180 minutes, To configure the file syncing profile, use the following commands

```
(host) [md] (config) #file syncing profile
(host) [md] (File syncing profile) #file-syncing-enable
(host) [md] (File syncing profile) #sync-time 30
```

## Related Show Commands

To view the version of Regulatory Cert currently active on all managed devices, execute the following command:

```
(host) [md] #show switches regulatory
```

To view the file syncing profile settings, execute the following command:

```
(host) [md] #show file syncing profile
```

ArubaOS incorporates Passpoint technology from the Wi-Fi Alliance HotSpot 2.0 (Release 1) Technical Specification Version 1.0.0 to simplify and automate access to public Wi-Fi networks. Follow the procedures in this chapter to help mobile devices identify which access points in your hotspot network are suitable for their needs, and authenticate to a remote service provider using suitable credentials.



---

Throughout this document, all references to Hotspot 2.0 refer to HotSpot 2.0 (Release 1) Technical Specification Version 1.0.0. Recent versions of this technical specifications exist, but they are not supported in this version of ArubaOS.

---

## Hotspot 2.0 Pre-Deployment Information

Hotspot 2.0 is a Wi-Fi Alliance Technical Specification for the Wi-Fi Alliance Wi-Fi CERTIFIED PassPoint program based upon IEEE P802.11u-2011 that provides wireless clients with a streamlined mechanism to discover and authenticate to suitable networks, and allows mobile users the ability to roam between partner networks without additional authentication. For an overview Hotspot 2.0 enhanced network discovery and selection technology, and a description of each of the hotspot profile types, see [Hotspot 2.0 Overview on page 814](#)

## Hotspot Profile Configuration Tasks

The following sections describe the procedure to configure the profiles for the hotspot feature.

- [Configuring Hotspot 2.0 Profiles on page 817](#)
- [Configuring Hotspot Advertisement Profiles on page 822](#)
- [Configuring ANQP Venue Name Profiles on page 824](#)
- [Configuring ANQP Network Authentication Profiles on page 826](#)
- [Configuring ANQP Domain Name Profiles on page 827](#)
- [Configuring ANQP IP Address Availability Profiles on page 828](#)
- [Configuring ANQP NAI Realm Profiles on page 829](#)
- [Configuring ANQP Roaming Consortium Profiles on page 833](#)
- [Configuring ANQP 3GPP Cellular Network Profiles on page 834](#)
- [Configuring H2QP Connection Capability Profiles on page 835](#)
- [Configuring H2QP Operator Friendly Name Profiles on page 837](#)
- [Configuring H2QP Operating Class Indication Profiles on page 838](#)
- [Configuring H2QP WAN Metrics Profiles on page 838](#)

## Hotspot 2.0 Overview

ArubaOS supports Hotspot 2.0 with enhanced network discovery and selection. Clients can receive general information about the network identity, venue, and type via management frames from the AP. Clients can also query APs for information about the network's available IP address type (IPv4 or IPv6), roaming partners, and supported authentication methods, and receive that information in ANQP Information Elements from the AP.

## Access Network Query Protocol

Access Network Query Protocol (ANQP) is an Advertisement Protocol implemented using the GAS frames allowing any STA to query another STA about ANQP elements even before the association event.

### ANQP Information Element

ANQP Information Elements are additional data that can be sent from the AP to any STA (including other APs) to provide identify of the AP's network and service provider. The STA can query for which ANQP elements are available for being query using the Query List element within a query, in which case the AP will reply with the Capability List elements indicating what other ANQP elements can be queried. Here are the ANQP elements that can be returned in the capabilities List element

- Venue Name: the this information element defines the venue group and venue type.
- Domain Name: this information element specifies the AP's domain name.
- Network Authentication Type: if the network has Additional Steps required for Access (ASRA), this information element defines the authentication type being used by the hotspot network.
- Roaming Consortium List: this information element contains information identifying the network and service provider, whose security credentials can be used to authenticate with the AP transmitting this element.
- IP address Availability: this information element provides clients with information about the availability of IP address versions and types which could be allocated to those clients after they associate to the hotspot AP.
- NAI Realm: this information element identifies and describes a NAI realm accessible using the AP and the method that this NAI realm uses for authentication.
- 3GPP Cellular Network Data: this information element defines information for a 3rd Generation Partnership Project (3GPP) Cellular Network for hotspots that have roaming relationships with cellular operators.
- Connection Capability: this information element defines hotspot protocol and port capabilities to be sent in an ANQP information element.
- Operating Class: this information element defines the channels on which the hotspot is capable of operating.
- Operator Friendly Name: this information element allows the definition of a free-form text field that can identify the operator and additional information about the location.
- WAN Metrics: this information element provides hotspot clients information about access network characteristics such as link status, capacity and speed of the WAN link to the Internet.

### Hotspot Profile Types

ArubaOS supports several different Hotspot 2.0 configuration profile types for defining ANQP information elements. The term H2QP is used to define profile that define Hotspot 2.0 specific Information Elements.

**Table 177: ANQP and H2QP Profiles referenced by an Advertisement Profile**

Profile	Description
Hotspot Advertisement profile	<p>An advertisement profile defines a collection of ANQP and H2QP profiles. Each hotspot 2.0 profile is associated with one advertisement profile, which in turn references one of each type of ANQP and H2QP profile.</p> <p>For more information on configuring this profile, refer to <a href="#">Configuring Hotspot Advertisement Profiles on page 822</a></p>
ANQP 3GPP Cellular Network profile	<p>Use this profile to define priority information for a 3rd Generation Partnership Project (3GPP) Cellular Network used by hotspots that have roaming relationships with cellular operators.</p> <p>For more information on configuring this profile, refer to <a href="#">Configuring ANQP 3GPP Cellular Network Profiles on page 834</a></p>
ANQP Domain Name profile	<p>Use this profile to specify the hotspot operator domain name.</p> <p>For more information on configuring this profile, refer to <a href="#">Configuring Hotspot Advertisement Profiles on page 822</a></p>
ANQP IP Address Availability profile	<p>Use this profile to specify the types of IPv4 and IPv6 IP addresses available in the hotspot network.</p> <p>For more information on configuring this profile, refer to <a href="#">Configuring ANQP IP Address Availability Profiles on page 828</a></p>
ANQP NAI Realm profile	<p>An AP's NAI Realm profile identifies and describes a Network Access Identifier (NAI) realm accessible using the AP, and the method that this NAI realm uses for authentication.</p> <p>For more information on configuring this profile, refer to <a href="#">Configuring ANQP NAI Realm Profiles on page 829</a></p>
ANQP Network Authentication profile	<p>Use the ANQP Network Authentication profile to define the authentication type used by the hotspot network.</p> <p>For more information on configuring this profile, refer to <a href="#">Configuring ANQP Network Authentication Profiles on page 826</a>.</p>
ANQP Roaming Consortium profile	<p>Name of the ANQP Roaming Consortium profile to be associated with this WLAN advertisement profile.</p> <p>For more information on configuring this profile, refer to <a href="#">Configuring ANQP Roaming Consortium Profiles on page 833</a></p>
ANQP Venue Name profile	<p>Use this profile to specify the venue group and venue type information be sent in an Access network Query Protocol (ANQP) information element in a Generic Advertisement Service (GAS) query response.</p> <p>For more information on configuring this profile, refer to <a href="#">Configuring ANQP Venue Name Profiles on page 824</a>.</p>
H2QP Connection Capability profile	<p>Use this profile to specify hotspot protocol and port capabilities.</p>



Profile	Description
	For more information on configuring this profile, refer to <a href="#">Configuring H2QP Connection Capability Profiles on page 835</a>
H2QP Operating Class Indication profile	Use this profile to specify the channels on which the hotspot is capable of operating  For more information on configuring this profile, refer to <a href="#">Configuring H2QP Operating Class Indication Profiles on page 838</a>
H2QP Operator Friendly Name profile	Use this profile to define the operator-friendly name sent by devices using this profile.  For more information on configuring this profile, refer to <a href="#">Configuring H2QP Operator Friendly Name Profiles on page 837</a>
H2QP WAN Metrics profile	Use this profile to specify the WAN status and link metrics for your hotspot.  For more information on configuring this profile, refer to <a href="#">Configuring H2QP WAN Metrics Profiles on page 838</a>

## Configuring Hotspot 2.0 Profiles

Use this profile to enable the hotspot 2.0 feature and define venue and OI settings for roaming partners. Each hotspot 2.0 profile also references an advertisement profile, which defines a set of ANQP or H2QP profiles which define other values for the hotspot feature. By default, hotspot 2.0 profiles reference the **default** advertisement profile. For information on associating a different advertisement profile with a hotspot 2.0 profile, see [Associating Advertisement Profile to Hotspot 2.0 Profile on page 823](#).

### In the WebUI

To configure a hotspot 2.0 profile from the WebUI:

1. In the **Mobility Master** node hierarchy, navigate to **Configuration > System > Profiles**.
2. In the **All Profiles** table, expand **Wireless LAN**.
3. Expand **Hotspot 2.0**. The list of available hotspot 2.0 profiles appears in the **All Profiles** table.
4. Select an existing Hotspot 2.0 profile from the list of profiles or create a new profile by clicking **+**.
5. Select **Advertise Hotspot 2.0 Capability**.
6. Configure the following parameters as desired, then click **Save** to save your settings.

**Table 178: Hotspot 2.0 Profile Settings**

Parameter	Description
Advertise Hotspot 2.0 Capability	<p>This check box enables or disables the Hotspot 2.0 capability. When this feature is enabled, the Information Elements (IEs) for this hotspot are included in beacons and probe responses from the AP and the ANQP Queries are answered to.</p> <p>This setting is disabled by default.</p>
Use GAS Comeback Request/Response	<p>By default, ANQP Information is obtained directly from a GAS Initial Response frame when size allows for it. If this parameter is enabled, advertisement information will not be included in the GAS Initial Response and will always force the usage of Comeback-Request and Comeback-Response frames.</p> <p>This option is disabled by default.</p>
Additional Steps required for Access Enabled	<p>This check box enables/disables the advertisement of Additional Steps Required for Access (ASRA) in the Internetworking information element.</p> <p><b>NOTE:</b> If this parameter is enabled, the advertisement profile for this hotspot must reference a network authentication type profile.</p>
Network Internet Access	<p>This check box enables/disables the advertisement of Internet access in the Internetworking information element.</p>
Length of Query Response	<p>The maximum number of 256 bytes that can be used for a GAS Initial-Response or GAS Comeback-Response frames. If the data exceeds this number, multiple Comeback-Response fragment will be used.</p> <p>The supported range is 1-256</p>
Access Network Type	<p>Specify the 802.11u network type. The default setting is public-chargeable.</p> <ul style="list-style-type: none"> <li>● <b>emergency-services:</b> emergency services only network</li> <li>● <b>personal-device:</b> personal device network</li> <li>● <b>private:</b> private network</li> <li>● <b>private-guest:</b> private network with guest access</li> <li>● <b>public-chargeable:</b> public chargeable network</li> <li>● <b>public-free:</b> free public network</li> <li>● <b>test:</b> test network</li> <li>● <b>wildcard:</b> wildcard network</li> </ul>
Roaming Consortium Len Entry 1	<p>Length of the OI. The value of the Roaming Consortium Len Entry 1 parameter is based upon the number of octets of the Roaming Consortium OI Entry 1 field.</p> <ul style="list-style-type: none"> <li>● <b>0:</b> Zero Octets in the OI (Null)</li> <li>● <b>3:</b> OI length is 24-bit (3 Octets)</li> <li>● <b>5:</b> OI length is 36-bit (5 Octets)</li> </ul>

Parameter	Description
Roaming Consortium OI Entry 1	<p>Roaming consortium OI assigned to one of the service provider's top three roaming partners. This additional OI will only be sent to a client if the Additional Roaming Consortium OI's parameter is set to 1 or higher.</p> <p><b>NOTE:</b> The service provider's own roaming consortium OI is configured using the ANQP Roaming Consortium profile.</p>
Roaming Consortium Len Entry 2	<p>Length of the OI. The value of the Roaming Consortium Len Entry 2 parameter is based upon the number of octets of the Roaming Consortium OI Entry 2 field.</p> <ul style="list-style-type: none"> <li>● <b>0:</b> Zero Octets in the OI (Null)</li> <li>● <b>3:</b> OI length is 24-bit (3 Octets)</li> <li>● <b>5:</b> OI length is 36-bit (5 Octets)</li> </ul>
Roaming Consortium OI Entry 2	<p>Roaming consortium OI assigned to one of the service provider's top three roaming partners. This additional OI will only be sent to a client if the Additional Roaming Consortium OI's parameter is set to 2 or higher.</p> <p><b>NOTE:</b> The service provider's own roaming consortium OI is configured using the ANQP Roaming Consortium profile.</p>
Roaming Consortium Len Entry 3	<p>Length of the OI. The value of the Roaming Consortium Len Entry -3 parameter is based upon the number of octets of the Roaming Consortium OI Entry 3 field.</p> <ul style="list-style-type: none"> <li>● <b>0:</b> Zero Octets in the OI (Null)</li> <li>● <b>3:</b> OI length is 24-bit (3 Octets)</li> <li>● <b>5:</b> OI length is 36-bit (5 Octets)</li> </ul>
Roaming Consortium OI Entry 3	<p>Roaming consortium OI assigned to one of the service provider's top three roaming partners. This additional OI will only be sent to a client if the Additional Roaming Consortium OI's parameter is set to 3.</p> <p><b>NOTE:</b> The service provider's own roaming consortium OI is configured using the ANQP Roaming Consortium profile.</p>
Additional Roaming Consortium OI's (displayed in Advertisement Profile)	<p>The number of additional ANQP Roaming Consortium profiles referenced by the Advertisement profile associated with this profile. The number must not include the OI defined within this Hotspot 2.0 profile.</p>
HESSID	<p>This optional parameter devices an AP's homogenous ESS identifier (HESSID), which is that device's MAC address in colon-separated hexadecimal format.</p>
Venue Group Type	<p>Specify one of the following venue groups to be advertised in the IEs from APs associated with this hotspot profile. The default setting is unspecified.</p> <ul style="list-style-type: none"> <li>● assembly</li> <li>● business</li> </ul>

Parameter	Description
	<ul style="list-style-type: none"> <li>educational</li> <li>factory-or-industrial</li> <li>institutional</li> <li>mercantile</li> <li>outdoor</li> <li>reserved</li> <li>residential</li> <li>storage</li> <li>unspecified</li> <li>Utility-Misc</li> <li>Vehicular</li> </ul> <p><b>NOTE:</b> This parameter only defines the venue group advertised in the IEs from hotspot APs.</p>
Venue Type	<p>Specify a venue type to be advertised in the IEs from APs associated with this hotspot profile. The complete list of supported venue types is described in <a href="#">Venue Types on page 825</a>.</p> <p>This parameter only defines the venue type advertised in the IEs from hotspot APs.</p>
PAME BI	<p>This option enables the Pre-Association Message Exchange BSSID Independent (PAME-BI) bit, which is used by an AP to indicate whether the AP indicates that the Advertisement Server can return a query response that is independent of the BSSID used for the GAS Frame exchange.</p>
Downstream Group Frames Forwarding Blocked	<p>This option configures the Downstream Group Addressed Forwarding (DGAF) Disabled Mode. If this feature is enabled, it ensures that the AP does not forward downstream group-addressed frames. It is disabled by default, allowing the AP to forward downstream group-addressed frames.</p>
Time Zone Format	<p>The time zone in which the AP is operating, in the format</p> <pre>&lt;std&gt;&lt;offset&gt;[dst [offset] [, start [/time], end [/time]]</pre> <p>Where the &lt;std&gt; string specifies the abbreviation of the time zone, &lt;dst&gt; is the abbreviation of the timezone in daylight savings time, and the &lt;offset&gt; string specifies the time value you must add to the local time to arrive at UTC.</p> <p><b>NOTE:</b> For complete details on configuring the timezone format, refer to section 8.3 of IEEE Std 1003.1, 2004 Edition.</p>
Time Advertisement Capability	<p>This parameter specifies the AP's source of external time, and the current condition of its timing estimator.</p> <ul style="list-style-type: none"> <li><b>no-std-ext-time-src:</b> The AP using this profile has no standardized external time source.</li> <li><b>timestamp-offset-utc:</b> The AP has a timestamp offset based on UTC.</li> <li><b>reserved:</b> This setting is reserved for future use, and should not be used.</li> </ul>

Parameter	Description
Time Error Value	The standard deviation of error in the time value estimate, in milliseconds. The default value is 0 milliseconds, and the supported range is 0-2,147,483,647 milliseconds.
P2P Device Management	Issue this command to advertise support for P2P device management. This setting is disabled by default.
P2P Cross Connect	Issue this command to advertise support for P2P Cross Connections. This setting is disabled by default.
Hotspot 2.0 Advertisement Protocol Type	The Access Network Query Protocol (ANQP) is used as the Hotspot 2.0 advertisement protocol types by default.
GAS comeback delay in milliseconds	At the end of the GAS comeback delay interval, the client may attempt to retrieve the query response using a Comeback Request Action frame. The supported range is 100-2000 milliseconds, and the default value is 500 milliseconds.
RADIUS Chargeable User Identity (RFC4372)	Include this parameter to enable the Chargeable-User-Identity RADIUS attribute defined by RFC 4372. Home networks can use this attribute to identify a user for the roaming transactions that take place outside of that home network.
RADIUS Location Data (RFC5580)	Include this parameter to enable the Location Data and Operator-Name RADIUS attributes defined by RFC 5580. The first ANQP Domain Name profile will be used as the Operator-Name value. Enabling this parameter allows the RADIUS server to use user location data.

## In the CLI

To configure a hotspot 2.0 profile from the CLI, access the CLI in config mode and issue the following commands:

```
wlan hotspot h2-profile <profile-name>
  access-network-type emergency-services|personal-device|private|private-guest|public-chargeable|public-free|test|wildcard
  addtl-roam-cons-ois <addtl-roam-cons-ois>
  advertisement-profile <profile-name>
  advertisement-protocol anqp|eas|mih-cmd-event|mih-info|rsvd
  asra
  clone <profile-name>
  comeback-mode
  gas-comeback-delay
  grp-frame-block
  hessid <id>
  hotspot-enable
  internet
  no ..
  p2p-cross-connect
  p2p-dev-mgmt
  pame-bi
  query-response-length-limit <query-response-length-limit>
  radius_cui
  radius_loc_data
```

```

roam-cons-len-1 0|3|5
roam-cons-len-2 0|3|5
roam-cons-len-3 0|3|5
roam-cons-oi-1 <roam-cons-oi-1>
roam-cons-oi-2 <roam-cons-oi-1>
roam-cons-oi-3 <roam-cons-oi-1>
time-advt-cap no-std-ext-timesrc|timestamp-offset-utc |reserved
time-error <milliseconds>
time-zone <time-zone>
venue-group <venue-group>
venue-type <venue-type>

```

## Configuring Hotspot Advertisement Profiles

An advertisement profile defines a set of ANQP and H2QP profiles for the hotspot feature. Advertisement profiles can reference multiple instances of some ANQP and H2QP profile types, but only a single instance of other ANQP and H2QP profiles. The table below shows how the different ANQP and H2QP profile types can be associated to a single advertisement profile.

**Table 179:** Hotspot Advertisement Profile Associations

One Instance per Advertisement Profile	Multiple Instances per Advertisement Profile
<ul style="list-style-type: none"> <li>ANQP IP address availability profile</li> <li>H2QP WAN metrics profile</li> <li>H2QP connection capability profile</li> </ul>	<ul style="list-style-type: none"> <li>ANQP venue name profile</li> <li>ANQP network authentication profile</li> <li>ANQP foaming consortium profile</li> <li>ANQP NAI realm profile</li> <li>ANQP 3GPP cellular network profile</li> <li>H2QP operator friendly name profile</li> <li>H2QP operating class indication profile</li> <li>ANQP domain Name profile</li> </ul>



For additional information on each of these profile types, see [Hotspot Profile Types on page 815](#)

## Configuring Advertisement Profile

The steps below describe the procedure to associate an advertisement profile to a set of ANQP and H2QP profiles.



The procedure to associate an ANQP or H2QP profile to an advertisement profile varies, depending upon whether the advertisement profile can reference just one instance or many instances of that profile type.

### In the WebUI

To configure an advertisement profile from the WebUI:

1. In the **Mobility Master** node hierarchy, navigate to **Configuration > System > Profiles**.
2. In the **All Profiles** table, expand **Wireless LAN**.
3. Expand **Advertisement**. The ANQP and H2QP profiles associated with the selected advertisement profile appear below the advertisement profile in the **All Profiles** table.

4. Select an existing advertisement profile from the list of profiles or create a new profile by clicking **+**.
5. For an ANQP or H2QP profile type that can have only one instance associated with the advertisement profile:
  - a. In the **All Profiles** table, select the ANQP or H2QP profile type.
  - b. Click the drop-down list in the **Network Profile** pane and select a profile name.
6. For an ANQP or H2QP profile type that can have multiple instances associated with the advertisement profile:
  - a. In the **All Profiles** table, select the ANQP or H2QP profile type.
  - b. In the **Network Profile** pane, click the profile drop-down list.
  - c. Select the name of the profile to associate with the advertisement profile.
  - d. Click **Save**.

### In the CLI

To configure a advertisement profile from the CLI, access the CLI in config mode and issue the following commands:

```
wlan hotspot advertisement profile <profile-name>
  anqp-3gpp-nwk-profile <profile-name>
  anqp-domain-name-profile <profile-name>
  anqp-ip-addr-avail-profile <profile-name>
  anqp-nai-realm-profile <profile-name>
  anqp-nwk-auth-profile <profile-name>
  anqp-roam-cons-profile <profile-name>
  anqp-venue-name-profile <profile-name>
  clone <profile-name>
  h2qp-conn-cap-profile <profile-name>
  h2qp-op-cl-profile <profile-name>
  h2qp-operator-friendly-profile <profile-name>
  h2qp-wan-metrics-profile <profile-name>
no ...
```

## Associating Advertisement Profile to Hotspot 2.0 Profile

The settings in the ANQP and H2QP profiles referenced by the Advertisement profile will not be sent to clients until you associate the advertisement profile with an active hotspot 2.0 profile. By default, all hotspot 2.0 profiles reference the **default** advertisement profile.

### In the WebUI

To associate a different advertisement profile to a hotspot 2.0 profile:

1. In the **Mobility Master** node hierarchy, navigate to **Configuration > System > Profiles**.
2. In the **All Profiles** table, expand **Wireless LAN**.
3. Expand **Hotspot 2.0**. The list of available hotspot 2.0 profiles appears in the **All Profiles** table.
4. Select an existing Hotspot 2.0 profile from the list of Hotspot 2.0 profiles.
5. Click **Advertisement** for the selected Hotspot 2.0 profile.
6. In the **All Profiles** table, click the **Advertisement Profile** drop-down list and select a different advertisement profile name.
7. Click **Save**.

### In the CLI

To associate a different advertisement profile to a hotspot 2.0 profile from the CLI, access the CLI in config mode and issue the following commands:

```
wlan hotspot hs2-profile <hotspot-profile-name>  
    advertisement-profile <advertisement-profile-name>
```

## Configuring ANQP Venue Name Profiles

Use this profile to define the venue group and venue type information which is sent in an Access network Query Protocol (ANQP) information element in a Generic Advertisement Service (GAS) query response.

To send the values configured in this profile to clients, associate this profile with an advertisement profile, then associate the advertisement profile with a Hotspot 2.0 profile. For additional details, see [Configuring Hotspot Advertisement Profiles on page 822](#).

### In the WebUI

To configure an ANQP venue name profile from the WebUI:

1. In the **Mobility Master** node hierarchy, navigate to **Configuration > System > Profiles**.
2. In the **All Profiles** table, expand **Wireless LAN**.
3. Expand **ANQP Venue Name**. The list of available ANQP venue name profiles appears in the **All Profiles** table.
4. Select an existing ANQP venue name profile from the list of profiles or create a new ANQP venue name profile by clicking **+**.
5. Configure the following parameters as desired, then click **Save** to save your settings.



**Table 180: ANQP Venue Name Profile Parameters**

Parameter	Description
Venue Group	<p>Specify one of the following venue groups to be advertised in the ANQP Information Elements (IEs) from APs associated with this profile. The default setting is unspecified.</p> <ul style="list-style-type: none"><li>• assembly</li><li>• business</li><li>• educational</li><li>• factory-or-industrial</li><li>• institutional</li><li>• mercantile</li><li>• outdoor</li><li>• reserved</li><li>• residential</li><li>• storage</li><li>• unspecified</li><li>• Utility-Misc</li><li>• Vehicular</li></ul>
Venue Language Code	<p>An ISO 639 language code that identifies the language used in the Venue Name field.</p>
Venue Name	<p>Venue name to be advertised in the ANQP IEs from APs associated with this profile. If the venue name includes spaces, the name must be enclosed in quotation marks, e.g. "Midtown Shopping Center".</p>
Venue Type	<p>Specify a venue type to be advertised in the IEs from APs associated with this hotspot profile. The complete list of supported venue types is described the table below</p>

## Venue Types

The following list describes the different venue types that may be configured in a Hotspot 2.0 or ANQP Venue Name profile:

<ul style="list-style-type: none"> <li>• assembly-amphitheater</li> <li>• assembly-amusement-park</li> <li>• assembly-arena</li> <li>• assembly-bar</li> <li>• assembly-coffee-shop</li> <li>• assembly-convention-center</li> <li>• assembly-emer-coord-center</li> <li>• assembly-library</li> <li>• assembly-museum</li> <li>• assembly-passenger-terminal</li> <li>• assembly-restaurant</li> <li>• assembly-stadium</li> <li>• assembly-theater</li> <li>• assembly-worship-place</li> <li>• assembly-zoo</li> <li>• business-attorney</li> <li>• business-bank</li> <li>• business-doctor</li> </ul>	<ul style="list-style-type: none"> <li>• business-fire-station</li> <li>• business-police-station</li> <li>• business-post-office</li> <li>• business-professional-office</li> <li>• business-research-and-development</li> <li>• educational-primary-school</li> <li>• educational-secondary-school</li> <li>• educational-university</li> <li>• industrial-factory</li> <li>• institutional-alcohol-or-drug-rehab</li> <li>• institutional-group-home</li> <li>• institutional-hospital</li> <li>• institutional-prison</li> <li>• institutional-terminal-care</li> <li>• mercantile-automotive-service-station</li> <li>• mercantile-gas-station</li> <li>• mercantile-grocery</li> <li>• mercantile-retail</li> </ul>	<ul style="list-style-type: none"> <li>• mercantile-shopping-mall</li> <li>• outdoor-bus-stop</li> <li>• outdoor-city-park</li> <li>• outdoor-kiosk</li> <li>• outdoor-muni-mesh-nwk</li> <li>• outdoor-rest-area</li> <li>• outdoor-traffic-control</li> <li>• residential-boarding-house</li> <li>• residential-dormitory</li> <li>• residential-hotel</li> <li>• residential-private-residence</li> <li>• unspecified</li> <li>• vehicular-airplane</li> <li>• vehicular-automobile</li> <li>• vehicular-bus</li> <li>• vehicular-ferry</li> <li>• vehicular-motor-bike</li> <li>• vehicular-ship</li> <li>• vehicular-train</li> </ul>
--	---	--

## In the CLI

To configure an ANQP venue name profile from the CLI, access the CLI in config mode and issue the following commands:

```
wlan hotspot anqp-venue-name-profile <profile-name>
  clone <profile-name>
  no ...
  venue-group outdoor|reserved|utility-misc|vehicular|assembly|business educational|factory-
or-industrial|institutional|mercantile|residential| storage|unspecified
  venue-language <language>
  venue-name <venue-name>
  venue-type <venue-type>
```

## Configuring ANQP Network Authentication Profiles

Use the ANQP Network Authentication profile to define the authentication type used by the Hotspot network.

To send the values configured in this profile to clients, associate this profile with an advertisement profile, then associate the advertisement profile with a Hotspot 2.0 profile. For additional details, see [Configuring Hotspot Advertisement Profiles on page 822](#).

## In the WebUI

To configure an ANQP network authentication profile from the WebUI:

1. In the **Mobility Master** node hierarchy, navigate to **Configuration > System > Profiles**.
2. In the **All Profiles** table, expand **Wireless LAN**.

3. Expand **ANQP Network Authentication**. The list of available ANQP network authentication profiles appears in the **All Profiles** table.
4. Select an existing ANQP network authentication profile from the list of profiles or create a new profile by clicking **+**.
5. Configure the following parameters as desired, then click **Save** to save your settings.

**Table 181: ANQP Network Authentication Profile Parameters**

Parameter	Description
Type of Network Authentication	<p>Network Authentication Type being used by the hotspot network.</p> <ul style="list-style-type: none"> <li>• <b>acceptance</b>: Network requires the user to accept terms and conditions. This option requires you to specify a redirection URL string as an IP address, FQDN or URL.</li> <li>• <b>dns-redirection</b>: Additional information on the network is provided through DNS redirection. This option requires you to specify a redirection URL string as an IP address, FQDN or URL.</li> <li>• <b>http-https-redirection</b>: Additional information on the network is provided through HTTP/HTTPS redirection.</li> <li>• <b>online-enroll</b>: Network supports online enrollment.</li> </ul>
Network Authentication URL	<p>URL, IP address, or FQDN used by the hotspot network for the <b>acceptance</b>, <b>dns-redirection</b>, or <b>online-enroll</b> network authentication types.</p>

## In the CLI

To configure an ANQP network authentication profile from the CLI, access the CLI in config mode and issue the following commands:

```
wlan hotspot anqp-nwk-auth-profile <profile-name>
  clone <profile-name>
  no ...
  nwk-auth-type acceptance|dns-redirection|http-https-redirection|online-enroll
  url <url>
```

## Configuring ANQP Domain Name Profiles

This profile defines the hotspot operator domain name to be sent in an Access Network Query Protocol (ANQP) information element in a Generic Advertisement Service (GAS) query response.

To send the values configured in this profile to clients, associate this profile with an advertisement profile, then associate the advertisement profile with a hotspot 2.0 profile. For additional details, see [Configuring Hotspot Advertisement Profiles on page 822](#).

## In the WebUI

To configure an ANQP domain name profile from the WebUI:

1. In the **Mobility Master** node hierarchy, navigate to **Configuration > System > Profiles**.
2. In the **All Profiles** table, expand **Wireless LAN**.
3. Expand **ANQP Domain Name**.
4. Select an existing profile from the list of profiles or create a new profile by clicking **+**.

5. In the **Domain Name** field, enter the domain name of the hotspot operator. Ensure that the alphanumeric text string is 32 characters or less.
6. Click **Save**.

### In the CLI

To configure an ANQP domain name profile from the CLI, access the CLI in config mode and issue the following commands:

```
wlan hotspot anqp-domain-name-profile <profile-name>
  clone <profile-name>
  domain-name <domain-name>
  no ...
```

## Configuring ANQP IP Address Availability Profiles

Use this profile to specify the types of IPv4 and IPv6 IP addresses available in the hotspot network. This information is sent in an Access network Query Protocol (ANQP) information element in a Generic Advertisement Service (GAS) query response.

To send the values configured in this profile to clients, associate this profile with an advertisement profile, then associate the advertisement profile with a Hotspot 2.0 profile. For additional details, see [Configuring Hotspot Advertisement Profiles on page 822](#).

### In the WebUI

To configure an ANQP IP address availability profile from the WebUI:

1. In the **Mobility Master** node hierarchy, navigate to **Configuration > System > Profiles**.
2. In the **All Profiles** table, expand **Wireless LAN**.
3. Expand **ANQP IP Address Availability**
4. Select an existing profile from the list of profiles or create a new profile by clicking **+**.
5. Configure the following parameters as desired, then click **Save** to save your settings.

**Table 182: ANQP IP Address Availability Profile Parameters**

Parameter	Description
IPv4 Address Availability Type	<p>Indicate the availability of an IPv4 network by clicking the <b>IPv4 Address Availability Type</b> drop-down list and selecting one of the following options:</p> <ul style="list-style-type: none"> <li>• availability-unknown: Network availability cannot be determined.</li> <li>• not-available: Network is not available.</li> <li>• port-restricted: Some ports are restricted (e.g., the network blocks port 110 to restrict POP mail).</li> <li>• port-restricted-double-nated: Some ports are restricted and multiple routers perform network address translation.</li> <li>• port-restricted-single-nated: Some ports are restricted and a single router performs network address translation.</li> <li>• private-double-nated: Network is a private network with multiple routers doing network address translation.</li> <li>• private-single-nated: Network is a private network a single router doing network address translation.</li> <li>• public: Network is a public network.</li> </ul>
IPv6 Address Availability Type	<p>Indicate the availability of an IPv6 network by clicking the <b>IPv6 Address Availability Type</b> drop-down list and selecting one of the following options:</p> <ul style="list-style-type: none"> <li>• available: An IPv6 network is available.</li> <li>• availability-unknown: Network availability cannot be determined.</li> <li>• not-available: Network is not available.</li> </ul>

## In the CLI

To configure an ANQP IP address availability profile from the CLI, access the CLI in config mode and issue the following commands:

```
wlan hotspot anqp-ip-addr-avail-profile <profile-name>
  clone <profile-name>
  ipv4-addr-avail availability-unknown|not-available|port-restricted|port-restricted-double-
nated|port-restricted-single-nated|private-double-nated|private-single-nated
  ipv6-addr-avail available|availability-unknown|not-available
  no ...
```

## Configuring ANQP NAI Realm Profiles

An AP's NAI Realm profile identifies and describes a Network Access Identifier (NAI) realm accessible using the AP, and the method that this NAI realm uses for authentication. These settings configured in this profile determine the NAI realm elements that are included as part of a GAS Response frame.

To send the values configured in this profile to clients, associate this profile with an advertisement profile, then associate the advertisement profile with a hotspot 2.0 profile. For additional details, see [Configuring Hotspot Advertisement Profiles on page 822](#).

## In the WebUI

To configure an ANQP NAI Realm profile from the WebUI:

1. In the **Mobility Master** node hierarchy, navigate to **Configuration > System > Profiles**.

2. In the **All Profiles** table, expand **Wireless LAN**.
3. Expand **ANQP NAI Realm**
4. Select an existing profile from the list of profiles or create a new profile by clicking + in the +.
5. Configure the following parameters as desired, then click **Save** to save your settings.

**Table 183:** ANQP NAI Realm Profile Parameters

Parameter	Description
NAI Realm name	Name of the NAI realm. The realm name is often the domain name of the service provider.
NAI Realm Encoding	Issue this command if the NAI realm name is a UTF-8 formatted character string that is not formatted in accordance with IETF RFC 4282.
NAI Realm EAP Method	<p>Select one of the options below to identify the EAP authentication method supported by the hotspot realm.</p> <ul style="list-style-type: none"> <li>• <b>crypto-card:</b> Crypto card authentication</li> <li>• <b>eap-aka:</b> EAP for Universal Mobile Telecommunications System (UMTS) Authentication and Key Agreement</li> <li>• <b>eap-sim:</b> EAP for GSM Subscriber Identity Modules</li> <li>• <b>eap-tls:</b> EAP-Transport Layer Security</li> <li>• <b>eap-ttls:</b> EAP-Tunneled Transport Layer Security</li> <li>• <b>generic-token-card:</b> EAP Generic Token Card (EAP-GTC)</li> <li>• <b>identity:</b> EAP Identity type</li> <li>• <b>notification:</b> The hotspot realm uses EAP Notification messages for authentication.</li> <li>• <b>one-time-password:</b> Authentication with a single-use password</li> <li>• <b>peap:</b> Protected Extensible Authentication Protocol</li> <li>• <b>peap-mschapv2:</b> Protected Extensible Authentication Protocol with Microsoft Challenge Handshake Authentication Protocol version 2</li> </ul>
NAI Realm Authentication Param ID 1	<p>Use the <b>NAI Realm Authentication Param ID 1</b> parameter to send the one of the following authentication methods for the primary NAI realm ID.</p> <ul style="list-style-type: none"> <li>• <b>credential-type:</b> The specified authentication ID uses credential authentication.</li> <li>• <b>expanded-eap:</b> The specified authentication ID uses the expanded EAP authentication method.</li> <li>• <b>expanded-inner-eap:</b> The specified authentication ID uses the expanded inner EAP authentication method.</li> <li>• <b>inner-auth-eap:</b> The specified authentication ID uses inner EAP authentication type.</li> <li>• <b>non-eap-inner-auth:</b> The specified authentication ID uses non-EAP inner authentication type.</li> </ul>

Parameter	Description
NAI Realm Authentication Param Value 1	<p>Use the <b>NAI Realm Authentication Param Value 1</b> parameter select an authentication value for the authentication method specified by the <b>NAI Realm Authentication Param ID 1</b> parameter.</p> <ul style="list-style-type: none"> <li>• cred-cert: Credential - Certificate</li> <li>• cred-hw-token: Credential - Hardware Token</li> <li>• cred-nfc: Credential - NFC</li> <li>• cred-none: Credential - None</li> <li>• cred-rsvd: Credential - Reserved</li> <li>• cred-sim: Credential - SIM</li> <li>• cred-soft-token: Credential - Soft Token</li> <li>• cred-user-pass: Credential - Username/password</li> <li>• cred-usim: Credential - USIM</li> <li>• cred-vendor-spec: Credential - Vendor-specific</li> <li>• eap-crypto-card: EAP Method - Crypto-card</li> <li>• eap-generic-token-card: EAP Method - Generic-Token-Card</li> <li>• eap-identity: EAP Method - Identity</li> <li>• eap-method-aka: EAP Method - AKA</li> <li>• eap-method-sim: EAP Method - SIM - GSM Subscriber Iden</li> <li>• eap-method-tls: EAP Method - TLS - Transport Layer Sec</li> <li>• eap-method-ttls: EAP Method - TTLS - Tunneled Transport Security</li> <li>• eap-notification: EAP Method - Notification</li> <li>• eap-one-time-password: EAP Method - One-Time-Password</li> <li>• eap-peap: EAP Method - PEAP</li> <li>• eap-peap-mschapv2: EAP Method - PEAP MSCHAP V2</li> <li>• non-eap-chap: Non-EAP Method - CHAP</li> <li>• non-eap-mschap: Non-EAP Method - MSCHAP</li> <li>• non-eap-mschapv2: Non-EAP Method - MSCHAPv2</li> <li>• non-eap-pap: Non-EAP Method - PAP</li> <li>• non-eap-rsvd: Non-EAP Method - Reserved for future use</li> <li>• reserved: Reserved for Future use</li> </ul>
NAI Realm Authentication Param ID 2	<p>Use the <b>NAI Realm Authentication ID Value 2</b> parameter to send the one of the following authentication methods for the secondary NAI realm ID.</p> <ul style="list-style-type: none"> <li>• credential-type: The specified authentication ID uses credential authentication.</li> <li>• expanded-eap: The specified authentication ID uses the expanded EAP authentication method.</li> <li>• expanded-inner-eap: The specified authentication ID uses the</li> </ul>

Parameter	Description
	<p>expanded inner EAP authentication method.</p> <ul style="list-style-type: none"> <li>● inner-auth-eap: The specified authentication ID uses inner EAP authentication type.</li> <li>● non-eap-inner-auth: The specified authentication ID uses non-EAP inner authentication type.</li> </ul>
NAI Realm Authentication Param Value 2	<p>Use the <b>NAI Realm Authentication Param Value 2</b> parameter select an authentication value for the authentication method specified by the <b>NAI Realm Authentication Param ID 2</b> parameter.</p> <ul style="list-style-type: none"> <li>● cred-cert: Credential - Certificate</li> <li>● cred-hw-token: Credential - Hardware Token</li> <li>● cred-nfc: Credential - NFC</li> <li>● cred-none: Credential - None</li> <li>● cred-rsvd: Credential - Reserved</li> <li>● cred-sim: Credential - SIM</li> <li>● cred-soft-token: Credential - Soft Token</li> <li>● cred-user-pass: Credential - Username/password</li> <li>● cred-usim: Credential - USIM</li> <li>● cred-vendor-spec: Credential - Vendor-specific</li> <li>● eap-crypto-card: EAP Method - Crypto-card</li> <li>● eap-generic-token-card: EAP Method - Generic-Token-Card</li> <li>● eap-identity: EAP Method - Identity</li> <li>● eap-method-aka: EAP Method - AKA</li> <li>● eap-method-sim: EAP Method - SIM - GSM Subscriber Iden</li> <li>● eap-method-tls: EAP Method - TLS - Transport Layer Sec</li> <li>● eap-method-ttls: EAP Method - TTLS - Tunneled Transport Security</li> <li>● eap-notification: EAP Method - Notification</li> <li>● eap-one-time-password: EAP Method - One-Time-Password</li> <li>● eap-peap: EAP Method - PEAP</li> <li>● eap-peap-mschapv2: EAP Method - PEAP MSCHAP V2</li> <li>● non-eap-chap: Non-EAP Method - CHAP</li> <li>● non-eap-mschap: Non-EAP Method - MSCHAP</li> <li>● non-eap-mschapv2: Non-EAP Method - MSCHAPv2</li> <li>● non-eap-pap: Non-EAP Method - PAP</li> <li>● non-eap-rsvd: Non-EAP Method - Reserved for future use</li> <li>● reserved: Reserved for Future use</li> </ul>
NAI Home Realm	Mark the realm in this profile as the NAI Home Realm



## In the CLI

To configure an ANQP NAI realm profile from the CLI, access the CLI in config mode and issue the following commands:

```
wlan hotspot anqp-nai-realm-profile <profile-name>
  clone <profile-name>
  nai-home-realm
  nai-realm-auth-id-1|nai-realm-auth-id-2 {credential-type|expanded-eap|expanded-inner-
  eap|inner-auth-eap|non-eap-inner-auth|tunneled-eap-credential-type}
  nai-realm-auth-value-1|nai-realm-auth-value-2 {cred-cert|cred-hw-token|cred-nfc|cred-
  none|cred-rsvd|cred-sim|cred-soft-token|cred-user-pass|cred-usim|cred-vendor-spec|eap-
  crypto-card|eap-generic-token-card|eap-identity|eap-method-aka|eap-method-sim|eap-method-
  tls|eap-method-ttls|eap-notification|eap-one-time-password|eap-peap|eap-peap-mschapv2|non-
  eap-chap|non-eap-mschap|non-eap-mschapv2|non-eap-pap|non-eap-rsvd|reserved}
  nai-realm-eap-method crypto-card|eap-aka|eap-sim|eap-tls|eap-ttls|generic-token-
  card|identity|notification|one-time-password|peap|peap-mschapv2
  nai-realm-encoding
  nai-realm-name <nai-realm-name>
  no ...
```

## Configuring ANQP Roaming Consortium Profiles

Organization Identifiers (OIs) are assigned to service providers when they register with the IEEE registration authority. You can specify the OI for the hotspot's service provider in the ANQP Roaming Consortium profile using the ANQP Roaming Consortium Profile. The Hotspot 2.0 profile also allows you to define and send up to three additional roaming consortium OIs for the service provider's top three roaming partners.

To send the values configured in this profile to clients, associate this profile with an advertisement profile, then associate the advertisement profile with a hotspot 2.0 profile. For additional details, see [Configuring Hotspot Advertisement Profiles on page 822](#).



---

Ensure that the Hotspot 2.0 profile Additional Roaming OI Consortium number is re-visited each time you add or remove one of those profile.

---

## In the WebUI

To configure an ANQP roaming consortium profile from the WebUI:

1. In the **Mobility Master** node hierarchy, navigate to **Configuration > System > Profiles**.
2. In the **All Profiles** table, expand **Wireless LAN**.
3. Expand **ANQP Roaming Consortium**.
4. Select an existing profile from the list of profiles or create a new profile by clicking **+**.
5. Configure the following parameters as desired, then click **Save** to save your settings.

**Table 184:** ANQP Roaming Consortium Profile Parameters

Parameter	Description
Roaming consortium OI Len	Length of the OI. The value of the <b>Roaming consortium OI Len</b> parameter must equal upon the number of octets of the <b>Roaming Consortium OI</b> field. <ul style="list-style-type: none"><li>• <b>0:</b> 0 Octets in the OI (Null)</li><li>• <b>3:</b> OI length is 24-bit (3 Octets)</li><li>• <b>5:</b> OI length is 36-bit (5 Octets)</li></ul>
Roaming Consortium OI	Send the specified roaming consortium OI in a GAS query response. The OI must be a hexadecimal number 3-5 octets in length.

## In the CLI

To configure an ANQP roaming consortium profile from the CLI, access the CLI in config mode and issue the following commands:

```
wlan hotspot anqp-roam-cons-profile <profile-name>  
  clone <profile-name>  
  no ...  
  roam-cons-oi <roam-cons-oi>  
  roam-cons-oi-len <roam-cons-oi-len>
```

## Configuring ANQP 3GPP Cellular Network Profiles

Use this profile to define priority information for a 3rd Generation Partnership Project (3GPP) Cellular Network used by hotspots that have roaming relationships with cellular operators.

To send the values configured in this profile to clients, associate this profile with an advertisement profile, then associate the advertisement profile with a hotspot 2.0 profile. For additional details, see [Configuring Hotspot Advertisement Profiles on page 822](#).

## In the WebUI

To configure an ANQP 3GPP cellular network profile from the WebUI:

1. In the **Mobility Master** node hierarchy, navigate to **Configuration > System > Profiles**.
2. In the **All Profiles** table, expand **Wireless LAN**.
3. Expand **ANQP 3GPP Cellular Network**.
4. Select an existing profile from the list of profiles or create a new profile by clicking **+**.
5. Configure the following parameters as desired, then click **Save** to save your settings.

**Table 185: ANQP 3GPP Cellular Network Profile Parameters**

Parameter	Description
3GPP PLMN1	The Public Land Mobile Networks (PLMN) value of the highest-priority network. The PLMN is comprised of a 12-bit Mobile Country Code (MCC) and the 12-bit Mobile Network Code (MNC).
3GPP PLMN2	The Public Land Mobile Networks (PLMN) value of the second-highest priority network. The PLMN is comprised of a 12-bit Mobile Country Code (MCC) and the 12-bit Mobile Network Code (MNC).
3GPP PLMN3	The Public Land Mobile Networks (PLMN) value of the third-highest priority network. The PLMN is comprised of a 12-bit Mobile Country Code (MCC) and the 12-bit Mobile Network Code (MNC).
3GPP PLMN4	The Public Land Mobile Networks (PLMN) value of the fourth-highest priority network. The PLMN is comprised of a 12-bit Mobile Country Code (MCC) and the 12-bit Mobile Network Code (MNC).
3GPP PLMN5	The Public Land Mobile Networks (PLMN) value of the fifth-highest priority network. The PLMN is comprised of a 12-bit Mobile Country Code (MCC) and the 12-bit Mobile Network Code (MNC).
3GPP PLMN6	The Public Land Mobile Networks (PLMN) value of the sixth-highest priority network. The PLMN is comprised of a 12-bit Mobile Country Code (MCC) and the 12-bit Mobile Network Code (MNC).

## In the CLI

To configure an ANQP 3GPP network profile from the CLI, access the CLI in config mode and issue the following commands:

```
wlan hotspot anqp-3gpp-nwk-profile <profile-name>
  3gpp_plmn1 <3GPP PLMN1 data>
  3gpp_plmn2 <3GPP PLMN2 data>
  3gpp_plmn3 <3GPP PLMN3 data>
  3gpp_plmn4 <3GPP PLMN4 data>
  3gpp_plmn5 <3GPP PLMN5 data>
  3gpp_plmn6 <3GPP PLMN6 data>
  clone <profile-name>
  enable
  no ...
```

## Configuring H2QP Connection Capability Profiles

Use this profile to specify hotspot protocol and port capabilities. This information is sent in a Access Network Query Protocol (ANQP) information element in a Generic Advertisement Service (GAS) query response.

To send the values configured in this profile to clients, associate this profile with an advertisement profile, then associate the advertisement profile with a hotspot 2.0 profile. For additional details, see [Configuring Hotspot Advertisement Profiles on page 822](#).

## In the WebUI

To configure a H2QP connection capability profile from the WebUI:

1. In the **Mobility Master** node hierarchy, navigate to **Configuration > System > Profiles**.
2. In the All profiles table, expand **Wireless LAN**.
3. Expand **H2QP Connection Capability**.
4. Select an existing profile from the list of profiles or create a new profile by clicking **+**.
5. Configure the following parameters as desired, then click **Save** to save your settings.

**Table 186:** ANQP Connection Capability Profile Parameters

Parameter	Description
H2QP Connection Capability ICMP Port	Select this option to enable the ICMP port. (port 0)
H2QP Connection Capability FTP port (TCP Protocol)	Select this option to enable the FTP port. (port 20)
H2QP Connection Capability SSH port (TCP Protocol)	Select this option to enable the SSH port. (port 22)
H2QP Connection Capability HTTP port (TCP Protocol)	Select this option to enable the HTTP port. (port 80)
H2QP Connection Capability TLS VPN port (TCP Protocol)	H2QP Connection Capability TLS VPN port(TCP Protocol)
H2QP Connection Capability PPTP VPN port (TCP Protocol)	Select this option to enable the PPTP port used by IPsec VPNs. (port 1723)
H2QP Connection Capability VOIP port (TCP Protocol)	Select this option to enable the TCP VoIP port. (port 5060)
H2QP Connection Capability VOIP port (UDP Protocol)	Select this option to enable the UDP VoIP port. (port 5060)
H2QP Connection Capability IKEv2 port for IPsec VPN	Select this option to enable the IPsec VPN port. (ports 500, 4500 and 0)
H2QP Connection Capability May be used by IKEv2 port for IPsec VPN	Select this option to enable the IKEv2 port 4500.
H2QP Connection Capability IKEv2 port for IPsec VPN	Select this option to enable the IKEv2 port 500.
H2QP Connection Capability ESP port(Used by IPsec VPN)	Include this parameter to enable the Encapsulating Security Payload (ESP) port used by IPsec VPNs. (port 0)

## In the CLI

To configure a H2QP connection capability profile from the CLI, access the CLI in config mode and issue the following commands:

```
wlan hotspot h2qp-conn-capability-profile <profile>
  clone <profile-name>
  esp
  icmp
  no ...
  tcp-ftp
  tcp-http
  tcp-pptp-vpn
  tcp-ssh
  tcp-tls-vpn
  tcp-voip
  udp-ike2-4500
  udp-ike2-500
  udp-ipsec-vpn
  udp-voip
```

## Configuring H2QP Operator Friendly Name Profiles

This profile defines an operator-friendly name sent by devices using this profile.

To send the values configured in this profile to clients, associate this profile with an advertisement profile, then associate the advertisement profile with a hotspot 2.0 profile. For additional details, see [Configuring Hotspot Advertisement Profiles on page 822](#).

## In the WebUI

To configure a H2QP operating class profile from the WebUI:

1. In the **Mobility Master** node hierarchy, navigate to **Configuration > System > Profiles**.
2. In the **All Profiles** table, expand **Wireless LAN**.
3. Expand **H2QP Operator Friendly Name**.
4. Select an existing profile from the list of profiles or create a new profile by clicking **+**.
5. Configure the following parameters as desired, then click **Save** to save your settings.

**Table 187:** H2QP Operator Friendly Name Profile Parameters

Parameter	Description
Operator Friendly Name Language Code	An ISO 639 language code that identifies the language used in the <b>Operator Friendly Name</b> field
Operator Friendly Name	An operator-friendly name sent by devices using this profile. The name can be up to 64 alphanumeric characters, and can include special characters and spaces. If the name includes quotation marks ("), include a backslash character (\) before each quotation mark. (e.g. \"example\")

## In the CLI

To configure a H2QP operator friendly name profile from the CLI, access the CLI in config mode and issue the following commands:

```
wlan hotspot h2qp-operator-friendly-name-profile <profile>
  clone <profile-name>
```

```
no ...
op-fr-name <op-fr-name>
op-lang-code <op-lang-code>
```

## Configuring H2QP Operating Class Indication Profiles

The values configured in this H2QP Operating Class Indication profile list the channels on which the hotspot is capable of operating. It may be useful where, for instance, a mobile device discovers a hotspot in the 2.4 GHz band but finds it is dual-band and prefers the 5 GHz band.

To send the values configured in this profile to clients, associate this profile with an advertisement profile, then associate the advertisement profile with a hotspot 2.0 profile. For additional details, see [Configuring Hotspot Advertisement Profiles on page 822](#).

### In the WebUI

To configure a H2QP operating class indication profile from the WebUI:

1. In the **Mobility Master** node hierarchy, navigate to **Configuration > System > Profiles**.
2. In the **All Profiles** table, expand **Wireless LAN**.
3. Expand **H2QP Operating Class Indication**.
4. Select an existing profile from the list of profiles or create a new profile by clicking **+**.
5. In the **H2QP Operating Class** field, enter a valid operating class value. (For a definition of these global operating classes refer to Table E-4 of IEEE Std 802.11-2012, Annex E.)
6. Click **Save**.

### In the CLI

To configure a H2QP operating class profile from the CLI, access the CLI in config mode and issue the following commands:

```
wlan hotspot h2qp-op-cl-profile <profile>
  clone <profile-name>
  op-cl <1-255>
```

## Configuring H2QP WAN Metrics Profiles

Use this profile to specify the WAN status and link metrics for your hotspot.

To send the values configured in this profile to clients, associate this profile with an advertisement profile, then associate the advertisement profile with a hotspot 2.0 profile. For additional details, see [Configuring Hotspot Advertisement Profiles on page 822](#).

### In the WebUI

To configure an ANQP venue name profile from the WebUI:

1. In the **Mobility Master** node hierarchy, navigate to **Configuration > System > Profiles**.
2. In the **All Profiles** table, expand **Wireless LAN**.
3. Expand **H2QP WAN Metrics**.
4. Select an existing profile from the list of profiles or create a new profile by clicking **+** in the **New Profile** table.
5. Configure the following parameters as desired, then click **Save** to save your settings.

**Table 188: H2QP WAN Metrics Profile Parameters**

Parameter	Description
H2QP WAN metrics link status	<p>Define the status of the WAN Link by clicking the <b>H2QP WAN metrics link status</b> drop-down list, and selecting one of the following values. The default link status is <b>reserved</b>, which indicates that the link status is unknown or unspecified</p> <ul style="list-style-type: none"> <li>• <b>link down:</b> WAN link is down.</li> <li>• <b>link test:</b> WAN link is currently in a test state.</li> <li>• <b>link up:</b> WAN link is up.</li> <li>• <b>reserved:</b> This parameter is reserved by the Hotspot 2.0 specification, and cannot be configured.</li> </ul> <p>Default: reserved</p>
H2QP WAN metrics symmetric WAN link	Select this check box to indicate that the WAN Link has same speed in both the uplink and downlink directions.
H2QP WAN metrics link at capacity	Select this check box to indicate that the WAN Link has reached its maximum capacity. If this parameter is enabled, no additional mobile devices will be permitted to associate to the hotspot AP.
WAN Metrics uplink speed	<p>This parameter defines the current WAN uplink speed in Kbps. If no value is set, this parameter will show a default value of 0 to indicate that the uplink speed is unknown or unspecified.</p> <p>Range: 0 - 2147483647, Default: 0</p>
WAN Metrics downlink speed	<p>This parameter defines the current WAN backhaul downlink speed in Kbps. If no value is set, this parameter will show a default value of 0 to indicate that the downlink speed is unknown or unspecified.</p> <p>Range: 0 - 2147483647, Default: 0</p>
WAN Metrics uplink load	<p>This parameter defines the percentage of the WAN uplink that is currently utilized. If no value is set, this parameter will show a default value of 0 to indicate that the downlink speed is unknown or unspecified.</p> <p>Range: 0-100; Default: 0</p>
WAN Metrics downlink load	<p>This parameter defines the percentage of the WAN downlink that is currently in use. If no value is set, this parameter will show a default value of 0 to indicate that the downlink speed is unknown or unspecified.</p> <p>Range: 0-100; Default: 0</p>
WAN Metrics load measurement duration	<p>Duration over which the downlink load is measured, in tenths of a second.</p> <p>Range: 0-65535; Default: 0</p>

## In the CLI

To configure a H2QP WAN metrics profile from the CLI, access the CLI in config mode and issue the following commands:

```
wlan hotspot h2qp-wan-metrics-profile <profile-name>
  at-capacity
  clone <profile-name>
```

```
downlink-load
downlink-speed
load-dur
no ...
symm-link
uplink-load
uplink-speed
wan-metrics-link-status link_down|link_test|link_up|reserved
```



The Software Defined Networking (SDN) Controller provides an improved networking infrastructure through the following enhancements:

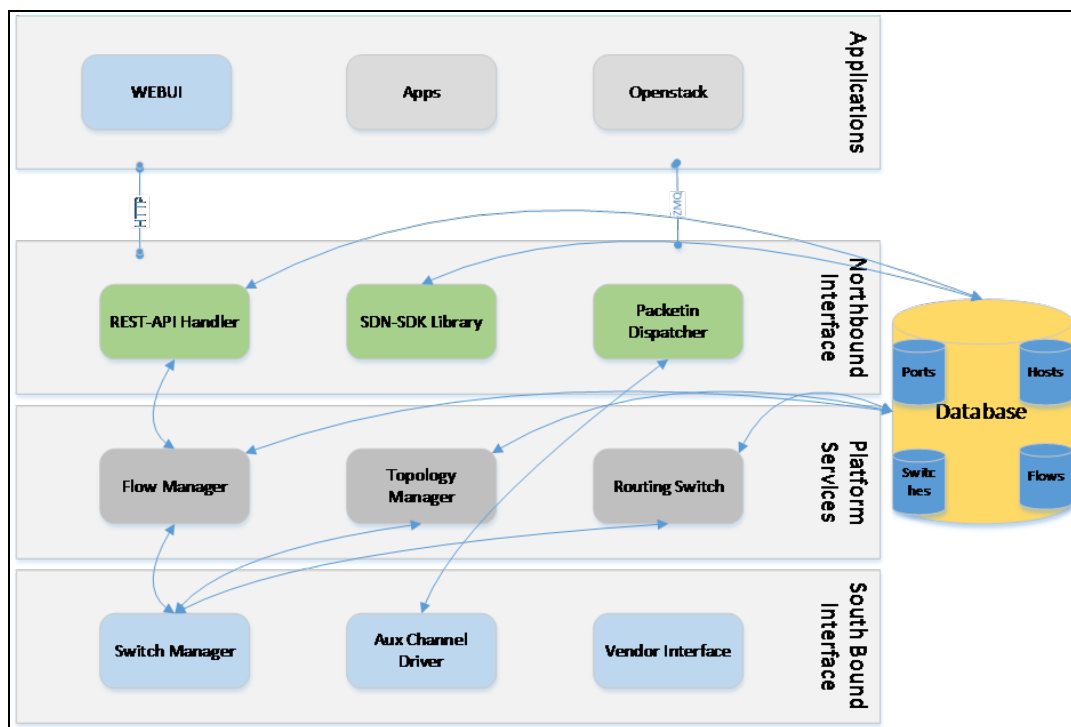
- Separation of control-plane and data-plane functions
- Centralized manageability
- Dynamic programmability of network devices

Traditional networks can experience high latency and inflexibility, as the number of new applications and features continues to grow. All control and forwarding functions take place on the same device, and features can only be provisioned statically through manual intervention. The SDN Controller provides a more efficient and simple way to build, deliver, and manage features throughout the network.

This section describes the following modules that make up the SDN Controller:

- [Southbound Interface on page 841](#)
- [SDN Platform Services on page 842](#)
- [Northbound API on page 852](#)

**Figure 105** SDN Controller Architecture



## Southbound Interface

The Southbound Interface is a collection of drivers that handles communication to all data-plane elements (DPE) in the network.

## OpenFlow Driver

The OpenFlow Driver supports the dynamic manipulation of network devices and the separation of fast-packet forwarding (data-plane) from high-level routing (control-plane). Data-plane functions reside on the DPE (switch), while control-plane functions have migrated to a separate controller. The OpenFlow switch and controller communicate through the OpenFlow protocol to provide functions such as host discovery and packet handling. OpenFlow allows users to run and manage multiple instances of the control-plane and data-plane from a centralized location.



---

The SDN Controller supports OpenFlow versions 1.0 and 1.3.

---

## Auxiliary Channel Driver

The Auxiliary Channel Driver carries all non-control data from the DPEs to the Mobility Master through UDP-based auxiliary channel connections. The auxiliary channel reduces bandwidth consumption and latency on the main channel, which must be used for critical functions such as flow programming or network state changes. All received data is sent to the subscribed Northbound APIs, which process and share the information with northbound applications.

The following items must be in place before an auxiliary channel connection can be used on the SDN Controller:

- Global OpenFlow configuration must be enabled on Mobility Master.
- The main channel must be UP.
- The listening port for the auxiliary connection must be configured (default connection is 6633).
- The source IP of the incoming UDP packets from the switch must be the same source IP used by the main channel connection.

For more information on configuring auxiliary channel ports, see [Enabling SDN Controller on Mobility Master on page 866](#)

## SDN Controller Configuration on Mobility Master

OpenFlow is an open communications interface between control plane and the forwarding layers of a network. OpenFlow allows dynamic manipulation of the forwarding plane for switches and routers. SDN architecture uses OpenFlow to enable software programs to manipulate the flow of packets in the network and to manage traffic based on the application's requirement.

OpenFlow Protocol v1.3 is used to achieve SDN with ArubaOS 8.0. An SDN controller runs on Mobility Master while an OpenFlow agent runs on the managed devices. For more information on OpenFlow agent, see [OpenFlow Agent on page 866](#). Mobility Master and the managed devices communicate over OpenFlow channels. The applications running in Mobility Master get all mDNS/SSDP packets seen by control plane on the managed devices. All outgoing mDNS/SSDP packets are originated by the application on Mobility Master.

For more information on SDN Controller configuration on Mobility Master, see [Enabling SDN Controller on Mobility Master on page 866](#)

## SDN Platform Services

SDN Platform Services gather and build the information required for core controller functions, including the following:

- Discovery of OpenFlow-capable devices and ports
- Discovery of all hosts and clients

- Discovery of the network topology
- Basic switching and routing
- Flow/policy programming
- Functionality to provide network paths between hosts
- Packet transmission
- Asynchronous event/state updates to Northbound applications

SDN Controller functions are achieved through the following services:

- Switch Discovery
- Topology discovery
- Host discovery
- Flow Management
- Packet Handling




---

The SDN Controller supports IPv6 flows and hosts. IPv6 host addresses can be learned in addition to IPv4 addresses.

---

## Switch Discovery

DPEs connect to the SDN Controller using the Transmission Control Protocol (TCP). Each TCP connection is terminated by a switch manager and initiates OpenFlow messages between the DPE and the SDN Controller. When a new switch is discovered, the OpenFlow driver sends a message to the topology manager, which creates a new switch entry in the Switch Database. Applications can subscribe to this message type to receive a notification each time a switch is discovered.

## Topology Discovery

The network topology displays the arrangement of switches and inter-switch links within the network. The complete topology view allows applications to:

- Make forwarding decisions
- Establish the shortest paths for flows
- Find alternate paths when links are congested or down
- Send low-latency flows on fast links and low-priority flows on slow links

The SDN Controller uses L3 LLDP to discover links between switches. The LLDP frame is encapsulated in an IP packet with a unique source and destination IP address, creating a clear separation between standard LLDP packets and LLDP packets generated by the SDN Controller.

The SDN Controller generates the network topology through the following steps:

1. For every link with an UP status, the controller sends an OpenFlow 'packet-out' message with an LLDP frame to the source switch (switch-1).
2. Switch-1 sends the LLDP frame to switch-2 through the specified link.
3. Switch-2 sends the LLDP frame back to the SDN controller through a 'packet-in' message.
4. Upon receiving the 'packet-in' message, the controller creates a link between the port number (port) and datapath ID (dpid) combination on switch-1 and port/dpid on switch-2.

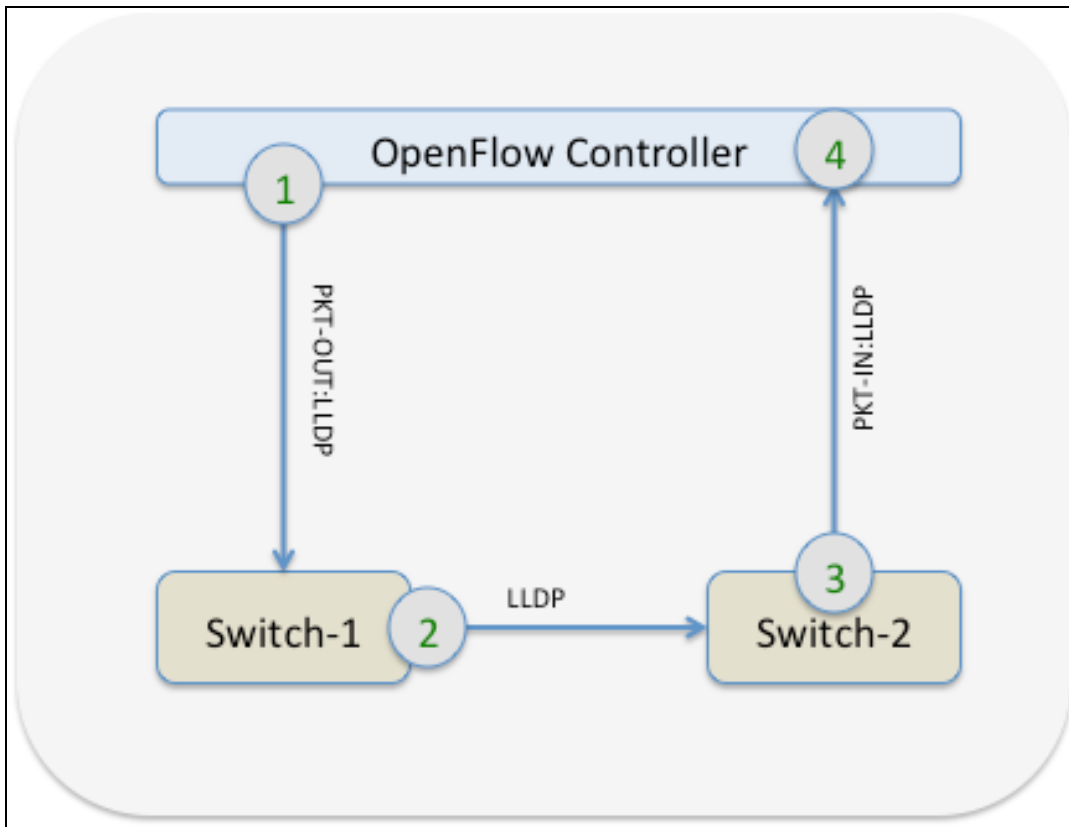



---

This process only creates a link in one direction. Steps 1-4 must be repeated to create a link from the opposite direction.

---

**Figure 106** *Topology Discovery*



## Host Discovery

The network topology can only be completed when all hosts are discovered by the controller. Hosts are defined by the port/dpid of the DPE to which they are connected. DPEs can run under hybrid mode (passive mode) or true OpenFlow mode (active mode).

When a host connects to a DPE, the host generates Address Resolution Protocol (ARP) packets that contain important mapping and identification information. When the DPE registers to the controller, the DPE mirrors these ARP packets from the host to the controller through a 'packet-in' message, in which the controller learns the IP-MAC binding, attachment point (port/dpid), and classification of the host.

Hosts can be classified as wireless or non-wireless, depending on the point of attachment. For example, if the port on the DPE is wireless, the host is marked as wireless.



---

Hosts can only be discovered by packets received through leaf links. Packets that are received through inter-switch links do not trigger host discovery on the controller.

---

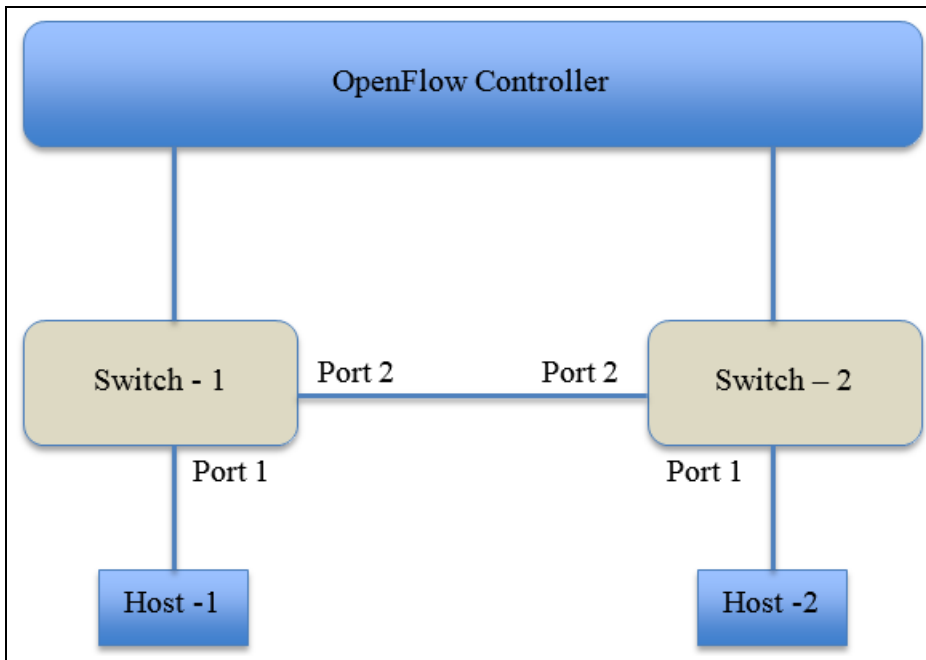


---

Hosts can only be classified as wireless if all wireless tunnels contain a "bss" keyword.

---

**Figure 107** Host Discovery



For example, in [Figure 107](#), the ARP packet generated by Host-1 triggers a 'packet-in' message from Switch-1 to the controller. Switch-2 also generates a 'packet-in' message when the ARP packet is forwarded from Port 2 of Switch-1. However, the controller ignores the message from Switch-2 since the ARP packet is received through an inter-switch link (see [Topology Discovery](#) for more details on inter-switch links). The controller learns that Host-1 is connected to Port-1 of DPID Switch-1.



---

IPv6 hosts are also discovered similarly using Internet Control Message Protocol version 6 (ICMPv6) neighbor discovery and solicitation packets.

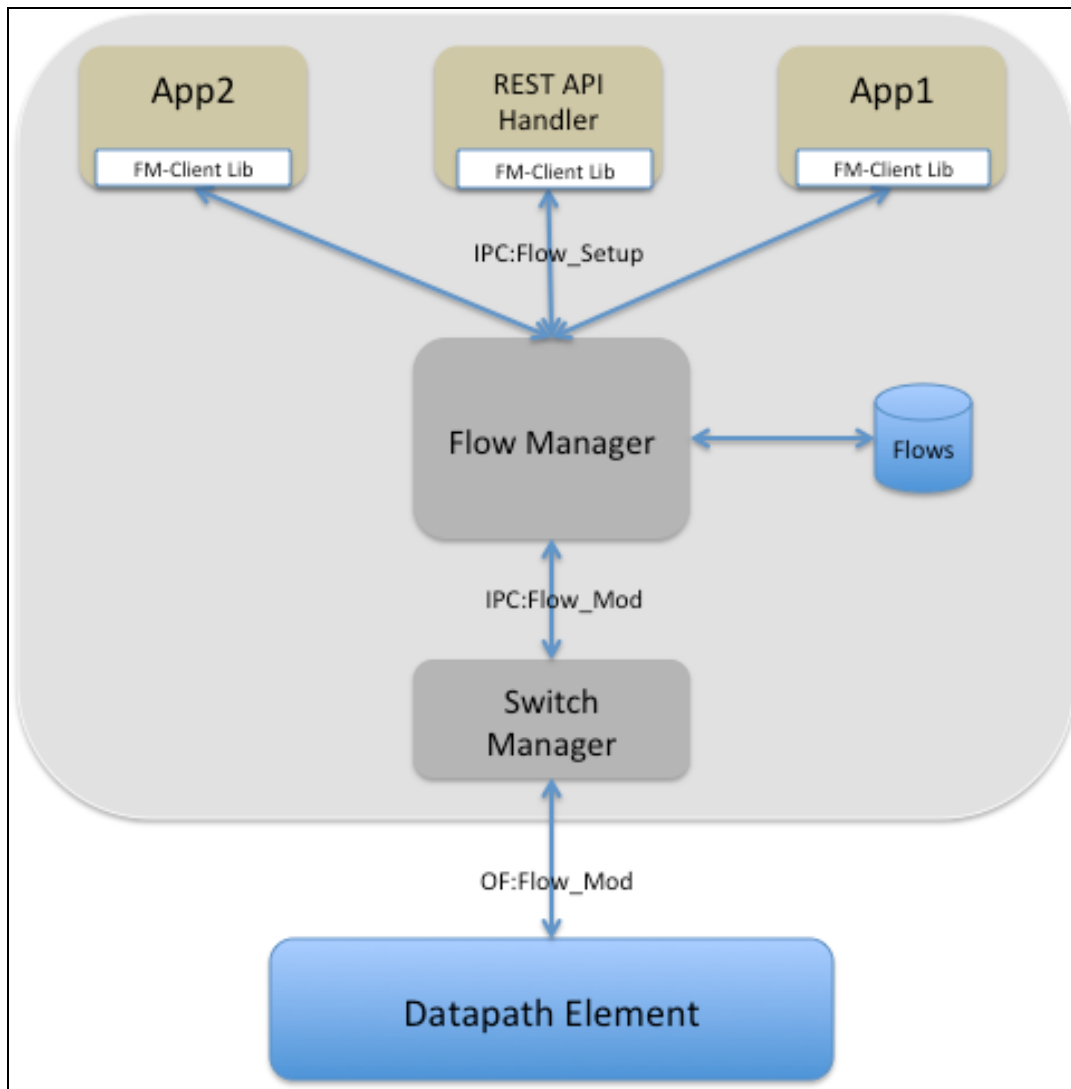
---

Host information is maintained in the Host Database, which is available to all SDN Controller applications and certain Northbound APIs. Host entries are aged out and deleted from the Host Database if no ARP packets for that host are received within the specified timeout period (default of 300 seconds).

## Flow Management

The flow manager programs and maintains flows that are pushed by applications on the controller. APIs from the SDN-SDK library interact with the flow manager to setup, update, or delete flows between applications and DPEs. A collection of flows that achieves a specific end-to-end policy or traffic forwarding process is referred to as a flow-group.

**Figure 108** *Flow Push*



The flow manager includes the following functions:

### Flow Installation

Flow installation is initiated when an application sends a flow setup message to the flow manager. The setup message contains the flow definition and allows the flow manager to check for any conflicting entries in the Flow Database. The flow is assigned a unique flow ID and flow-group ID by the application. The flow manager completes the installation process by sending a flow modification message to the switch manager that handles the target DPE.

### Flow Match and Actions

The SDN Controller presents a uniform interface for flow installation, regardless of the OpenFlow version. Fields from incoming packets are matched against flow entries (match fields) to perform a specific set of actions. Refer to [Table 189](#) to view the complete list of supported match fields and [Table 190](#) to view the complete lists of supported actions.

**Table 189: Flow Match Fields**

test

Match Field	Description	Mandatory	Maskable	Type	Example
switch	DIPID of the switch.	Yes	No	String	00:00:00:1a:1e:00:3b:40
priority	Priority of the flow.	Yes	No	Integer	32768
idle-timeout	Idle-timeout, after which a flow is deleted based on the time period since activity was last detected.	No	No	Integer	30 seconds
hard-timeout	Hard-timeout, after which a flow is deleted based on the time period since the flow was created.	No	No	Integer	30 seconds
ingress-port	Ingress port of the packet.	No	No	Integer	1
src-mac	Source MAC address on the ether header.	No	No	String	00:1a:1e:00:3b:40
dst-mac	Destination MAC address on the ether header.	No	No	String	00:1a:1e:00:3b:40
ether-type	Type of ether header.	No	No	Integer	2048 (IPv4)
vlan	VLAN ID.	No	No	Integer	20
vlan-priority	VLAN priority.	No	No	Integer	6
src-ip	Source IP address on the IP header.	No	Yes	String	10.10.10.10
src-ip-mask	Number of bits to mask from the LSB.	No	—	Integer	8 (/24 mask)
dst-ip	Destination IP address on the IP header.	No	Yes	String	10.10.10.11
dst-ip-mask	Number of bits to mask from the LSB.	No	—	Integer	24 (/8 mask)

Match Field	Description	Mandatory	Maskable	Type	Example
src-ipv6	Source IPv6 address on the IP header.	No	Yes	String	fe80::1a:1e0f:ff00:3b41/64
src-ipv6-mask	Number of bits to mask from the LSB.	No	—	Integer	64
dst-ipv6	Destination IPv6 address on the IP header.	No	Yes	String	fe80::1a:1e0f:ff00:3b41/64
dst-ipv6-mask	Number of bits to mask from the LSB.	No	—	Integer	32
icmpv6-type	Internet Control Message Protocol version 6 (ICMPv6) type.	No	No	Integer	135 (neighbor solicitation)
icmpv6-code	ICMPv6 code.	No	No	Integer	0
ip-tos	Type of Service (ToS) bits on the IP header.	No	No	Integer	34
protocol	Protocol on the IP header.	No	No	Integer	6 (TCP)
src-port	Source port on the IP header.	No	No	Integer	5353 (MDNS)
dst-port	Destination port on the IP header.	No	No	Integer	5353 (MDNS)
app-name	Name of the application installing the flow.	No	No	String	airgroup
src-port-start	Start of the source port range.	No	No	Integer	5000
src-port-end	End of the source port range.	No	No	Integer	5010
dst-port-start	Start of the destination port range.	No	No	Integer	6000
dst-port-end	End of the destination port range.	No	No	Integer	6010



**Table 190: Flow Actions**

Action Field	Description	Example
output	Port on which the packet is sent out.	<ul style="list-style-type: none"> <li>• Controller</li> <li>• Flood</li> <li>• All</li> <li>• Normal</li> </ul>
set-vlan-id	Configures the VLAN ID on the VLAN header.	20
set-vlan-priority	Configures the VLAN priority on the VLAN header.	7
set-src-mac	Configures the source MAC address on the ether header.	00:1a:1e:00:3b:40
set-dst-mac	Configures the destination MAC address on the ether header.	00:1a:1e:00:3b:40
set-src-ip	Configures the source IP address on the IP header.	20.20.20.20
set-dst-ip	Configures the destination IP address on the IP header.	20.20.20.20
set-tos-bits	Configures Type of Service (ToS) bits on the IP header.	42
set-flag	<p>Updates session flags in the datapath to further process traffic.</p> <p><b>NOTE:</b> This action is only available on Aruba OpenFlow switches.</p>	VH
write-flag	<p>Overwrites datapath session flags.</p> <p><b>NOTE:</b> This action is only available on Aruba OpenFlow switches.</p>	VH
aruba-output	<p>Sets a maximum packet number for the specified flow output. Only the specified number of packets is mirrored to the output for the flow.</p> <p><b>NOTE:</b> This action is only available on Aruba OpenFlow switches.</p>	controller:10 (indicates that only the first 10 packets are forwarded to the controller)
set-appid	<p>Sets an application ID on a datapath session after deep packet inspection (DPI) has been performed.</p> <p><b>NOTE:</b> This action is only available on Aruba OpenFlow switches.</p>	Netflix

## Flow Update

Applications can use this function to update the action list associated with an existing flow. The application must obtain the new action list and the ID of the existing flow/flow-group to create a flow update request. After the request is accepted, the flow manager locates and updates the existing flow in the Flow Database.

## Flow Deletion

The SDN Controller supports the following methods to delete a flow:

- Applications can explicitly call for a flow delete to remove a flow from the switch.
- Flows can be removed asynchronously through an idle-timeout or hard-timeout. Idle-timeout specifies the time period since activity was last detected for a flow. Hard-timeout specifies the time period since the flow was created.

After a flow is deleted, the controller removes all references to the flow and notifies northbound applications about the deletion.



---

Individual flows within a flow-group cannot be deleted; the entire flow-group must be deleted.

---

## Flow Statistics

The flow manager sends statistics request messages to the DPEs to update statistics in the Flow Database every 30 seconds. Separate request messages are sent for each flow bucket, based on the corresponding cookie ID and cookie mask value. This bucket-based statistics collection improves the overall performance of the flow manager and DPEs since flow statistics can be processed through multiple (smaller) requests.

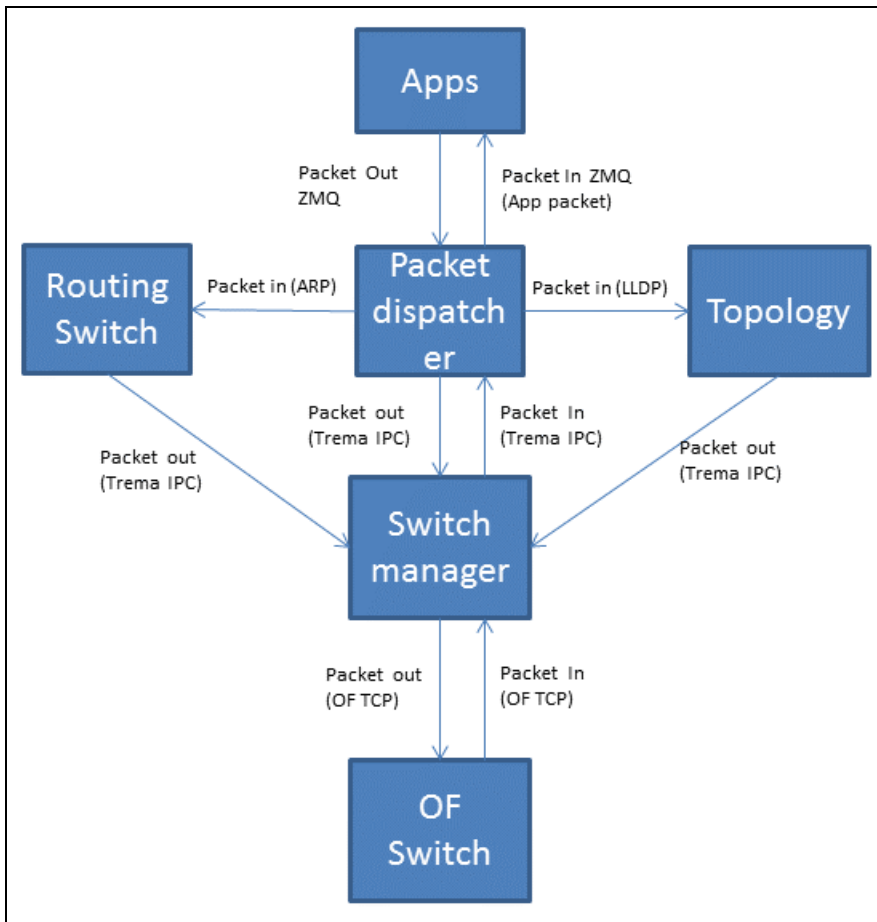
## Databases

A copy of every network flow is maintained and readily accessible in the Flow Database. The storage of flows in a database prevents data or state loss during process crashes and provides information to read-only applications without requiring communication with any infrastructure processes.

## Packet Handling

One of the major functions of the SDN Controller is to facilitate packet processing throughout the network. Packets that are sent from switches are called 'packet-in'. Packets that are sent to switches are called 'packet-out'. The following figure displays the packet-in and packet-out flow within the network.

**Figure 109** Packet Handling



When a northbound application, routing switch, or topology manager sends a 'packet-out' message, the packet is sent to the packetin-dispatcher, which handles all packet-related functionality, such as the port number and datapath ID (dpid) to which the packet must be sent. The packet is then sent to the switch manager, which processes and sends the packet to the respective DPE (based on the designated port/dpid), where additional forwarding processes can be handled.

When a switch sends a 'packet-in' message, the packet is sent to the packetin-dispatcher through the switch manager. The packetin-dispatcher classifies and delivers the packet to the routing switch, topology manager, or Northbound APIs.

## OpenFlow Version Support

The SDN Controller supports OpenFlow versions 1.0 and 1.3. The controller dynamically negotiates with the DPEs to select the highest common version.

## IPv6 Support

The SDN Controller supports IPv6 flows and hosts. Flow match conditions can include the following:

- IPv6 as an ether type value
- IPv6 address as an src-ip or dst-ip value
- ICMPv6 type and code

The controller can learn IPv6 addresses in addition to IPv4 addresses.

## High Availability

With the centralization of features and management functions on the SDN Controller, a single instance of the controller creates a single point of failure. The SDN Controller supports the Virtual Router Redundancy Protocol (VRRP) to reduce downtime and client traffic disruptions during network upgrades or unexpected failures. See [Increasing Network Uptime Through Redundancy and VRRP](#) for more details on high availability and VRRP.

### VRRP

VRRP provides a redundancy solution, in which two or more systems, such as a primary and backup controller, share a virtual IP address. When the primary SDN Controller fails, the agents (DPEs) that are connected to the primary controller time out and reconnect to the backup controller associated with the same virtual IP.

Under the SDN Controller, the primary and backup controllers do not undergo a state sync. The following must be rebuilt on the backup controller:

- The backup controller must learn and compute the network topology.
- Previous hosts may not be available immediately on the system. The Host Database must be rebuilt.
- Upon switch discovery, applications must re-push all flows to the switches.

VRRP failovers are transparent for northbound applications that use REST APIs, as REST APIs continue to provide services despite any system failures. However, applications must re-subscribe to the ZMQ APIs.

## Northbound API

The Northbound API makes the information built from the SDN Controller available for applications. The Northbound API consists of the following API types:

- **Synchronous:** Synchronous APIs are initiated by the client, and the information is presented through the server in response to the API. Synchronous APIs can be classified into two categories:
  - **Get/Fetch:** These APIs obtain information about the network without affecting the state of the network.
  - **Push/Post/Modify:** These APIs modify the state of the network.
- **Asynchronous:** Asynchronous APIs notify northbound applications about changes in the network through server-to-client communication.

### Synchronous APIs

Synchronous APIs are implemented through the REST API (Representational State Transfer) using standard HTTP GET, POST, and DELETE methods. REST provides a uniform interface between clients and servers, while allowing them to exist independently without any state transfers. A new request must be made by the client through a fetch mechanism or a single API each time the information is desired. Refer to the sections below to view the REST APIs that are available on the SDN Controller.



---

The SDN Controller provides multi-version support and backwards compatibility for REST APIs

---

### Switch API

The Switch API returns information about switches in the network, using the HTTP GET method.

**Table 191: Switch API Query Parameters**

Query Parameter	Definition
switch	Lists all switches in the network.
switch?dpid	Lists all switches associated with a specific DPID.

The output for this message type displays the following information:

**Table 192: Switch API Output Parameters**

Output Parameter	Definition
add-time	Time that the switch is added to the network.
auxiliary-id	ID number identifying the auxiliary channel.
auxiliary-status	Indicates if the auxiliary channel is <b>Up</b> or <b>Down</b> .
auxiliary-update-time	Time that the auxiliary channel is updated.
capabilities	Switch capabilities, such as flow statistics or port statistics.
description	Information about the switch, including the model and version of the switch.
disconnect-time	Time that the switch disconnects from the network.
ip	IP address of the switch.
port	Remote TCP port of the switch.
ports	Displays the list of ports on the switch.
name	Name of the port.
port-mac	MAC address of the port.
port-no	Port number.
rx-packets	Total number of packets received on the port.
status	Status of the port.
tx-packets	Total number of 802.11 packets transmitted by the port.
reconnect-time	Time that the switch reconnects to the network.

Output Parameter	Definition
secure-connection	Indicates if a secure connection is <b>Enabled</b> or <b>Disabled</b> on the switch.
status	Indicates if the switch is <b>Up</b> or <b>Down</b> .
switch	MAC address of the switch.
version	OpenFlow version of the switch: <ul style="list-style-type: none"> <li>• v1.0</li> <li>• v1.3</li> </ul>

The Switch API displays output similar to the example below:

```
#curl --insecure -b aruba-cookie https://10.4.251.105:4343/sdn/v1/switch
[
  {
    "add-time": "Mon Jun 29 07:54:10 2015\n",
    "auxiliary-id": 1,
    "auxiliary-status": "Up",
    "auxiliary-update-time": "Wed May 18 02:54:49 2016\n",
    "capabilities": [
      "Flow statistics",
      "Table statistics",
      "Port statistics",
      "Queue statistics"
    ],
    "description": "Aruba Networks, Inc. Aruba7210 VERSION 6.4 None None",
    "disconnect-time": "Mon Jun 29 09:48:21 2015\n",
    "ip": "10.4.251.79",
    "port": 51898,
    "ports": [
      {
        "name": "GE0/0/2",
        "port-mac": "00:1a:1e:00:3b:43",
        "port-no": 1,
        "rx-packets": 0,
        "status": 0,
        "tx-packets": 0
      },
      {
        "name": "GE0/0/3",
        "port-mac": "00:1a:1e:00:3b:44",
        "port-no": 2,
        "rx-packets": 0,
        "status": 0,
        "tx-packets": 0
      }
    ],
    "reconnect-time": "Mon Jun 29 09:48:24 2015\n",
    "secure-connection": "Disabled",
    "status": "Up",
    "switch": "00:00:00:1a:1e:00:3b:40",
    "version": "v1.3"
  }
]
```

## Host API

The Host API returns information about the hosts that are connected to the network, using the GET HTTP method.

**Table 193:** *Host API Query Parameters*

Query Parameter	Definition
host	Lists all hosts in the network.
host?mac	Lists all hosts associated with a specific MAC address.
host?ip	Lists all hosts associated with a specific IP address.
host?ip & timeout	Lists all hosts associated with a specific IP address and timeout period.
host?start	Controls paging of results by pointing to the starting object.
host?limit	Controls paging of results by limiting the number of objects to be returned.
host?direction	Controls paging of results by setting the direction to "next" or "prev".

The output for this message type displays the following information:

**Table 194:** *Host API Output Parameters*

Output Parameter	Definition
attachment-point	Information on the host's attachment point.
port	Number of the port to which the host is connected.
port-mac	MAC address of the port to which the host is connected.
switch	MAC address of the switch to which the host is connected.
created-at	Time that the host entry is created.
host-mac	MAC address of the host.
idle-for	Amount of time that host is idle, in seconds.
ip-addr	IP address of the host.
up-time	Amount of time that the host is up, in seconds.
wireless	Indicates if the host is wireless.

Output Parameter	Definition
object-count	Number of objects to be returned.
page-info	Information about result pages.
next-id	ID number of the next page.
previous-id	ID number of the previous page.
response-time	Query response time, in microseconds.

The Host API displays output similar to the example below:

```
#curl --insecure -b aruba-cookie https://10.4.251.105:4343/sdn/v1/host
[
  {
    "attachment-point": {
      "port": 3,
      "port-mac": "00:1a:1e:00:3b:46",
      "switch": "00:00:00:1a:1e:00:3b:40"
    },
    "created-at": "Mon Jun 29 01:36:51 2015\n",
    "host-mac": "00:00:5e:00:01:01",
    "idle-for": 39464,
    "ip-addr": [
      "63.82.214.201"
    ],
    "up-time": 40037,
    "wireless": false
  }
]
"Meta-Info": {
  "object-count": 4,
  "page-info": {
    "next-id": "573b0fd3cf42dcb5ab9c7c40"
    "previous-id": "573b0fd3cf42dcb5ab9c7c20"
  },
  "response-time (micros)": 607
}
}
```

## Flows API

The Flows API returns information about the flows between applications and DPEs, using the HTTP GET method.



**Table 195: Flows API Query Parameters**

Query Parameter	Definition
flows	Lists all flows between applications and DPEs.
flows?flow-group-id	Lists all flows associated with a specific flow-group.
flows?flow-id	Lists all flows associated with a specific flow ID.
flows?dpid	Lists all flows associated with a specific dpid.
flows?start	Controls paging of results by pointing to the starting object.
flows?limit	Controls paging of results by limiting the number of objects to be returned.
flows?direction	Controls paging of results by setting the direction to "next" or "prev".

The output for this message type displays the following information:

**Table 196: Flows API Output Parameters**

Output Parameter	Definition
actions	Action(s) used by the flow. See <a href="#">Table 195</a> for the complete list of flow actions.
byte-count	Total byte count of the flow.
cookie	Cookie ID to which the flow is assigned.
created-at	Time that the flow entry is created.
dst-ip	Destination IP address of the flow.
ether-type	Ethertype used by the ether header.
flow-group-id	Flow-group ID.
flow-id	Flow ID.
hard-timeout	Hard-timeout, after which a flow is deleted based on the time period since the flow was created.
idle-timeout	Idle-timeout, after which a flow is deleted based on the time period since activity was last detected.
packet-count	Number of packets transmitted by the flow.

Output Parameter	Definition
priority	Priority of the flow.
protocol	Protocol used by the flow (for example, TCP).
src-ip	Source IP address of the flow.
status	Status of the flow (for example, "install-confirmed").
switch	MAC address of the switch to which the flow is connected.
object-count	Number of objects to be returned.
page-info	Information about result pages.
next-id	ID number of the next page.
previous-id	ID number of the previous page.
response-time	Query response time, in microseconds.

The Flows API displays output similar to the example below:

```
#curl --insecure -b aruba-cookie https://10.4.251.105:4343/sdn/v1/flows
[
  {
    "actions": "output=controller",
    "byte-count": 0,
    "cookie": 281474976710660,
    "created-at": "Mon Jun 29 07:54:10 2015\n",
    "dst-ip": "2.2.2.2",
    "ether-type": 2048,
    "flow-group-id": 1007117466670727170,
    "flow-id": 1007117466670791846,
    "hard-timeout": 0,
    "idle-timeout": 0,
    "packet-count": 0,
    "priority": 65535,
    "protocol": 97,
    "src-ip": "1.1.1.1",
    "status": "Install-Confirmed",
    "switch": "00:00:00:1a:1e:00:3b:40"
  }
]
"Meta-Info": {
  "object-count": 4,
  "page-info": {
    "next-id": "573b0fd3cf42dcb5ab9c7c40"
    "previous-id": "573b0fd3cf42dcb5ab9c7c20"
  },
  "reponse-time (micros)": 607
}
}
```

## Links API

The Links API returns information about the inter-switch links that create the network topology, using the HTTP GET method.

**Table 197:** *Links API Query Parameters*

Query Parameter	Definition
links	Lists all links that make up the network topology.

The output for this message type displays the following information:

**Table 198:** *Links API Output Parameters*

Output Parameter	Definition
from-port	Port number of the source switch.
from-switch	MAC address of the source switch.
status	Status of the inter-switch link.
to-port	Port number of the destination switch.
to-switch	MAC address of the destination switch.

The Links API displays output similar to the example below:

```
#curl --insecure -b aruba-cookie https://10.4.251.201:4343/sdn/v1/links
[
  {
    "from-port": 2,
    "from-switch": "00:00:00:00:00:00:03",
    "status": 1,
    "to-port": 1,
    "to-switch": "00:00:00:00:00:00:04"
  }
]
```

## Path API

The Path API returns information on the path between two ports (hosts) in the network, using the HTTP GET method. Query the Host API to find the attachment point for each host, and then query the Path API to locate the path between the two attachment points.

**Table 199:** *Path API Query Parameters*

Query Parameter	Definition
path?src-spid&src-port&dst-dpid&dst-port	Lists a series of dpid's and ports, which constitute the path between the source dpid/port and destination dpid/port.

The output for this message type displays the following information:

**Table 200: Path API Output Parameters**

Output Parameter	Definition
inPort	Ingress port of a switch in the path.
outPort	Egress port of a switch in the path.
switchDPID	Datapath ID of a switch in the path.

The Path API displays output similar to the example below:

```
#curl --insecure -b aruba-cookie
https://10.4.251.105:4343/sdn/v1/path?00:00:00:1a:1e:00:3b:40/1/00:00:00:1a:1e:00:3b:90/2
[
  {
    "inPort": 1,
    "outPort": 2,
    "switchDPID": "00:00:00:1a:1e:00:3b:40"
  },
  {
    "inPort": 3,
    "outPort": 2,
    "switchDPID": "00:00:00:1a:1e:00:3b:90"
  }
]
```

## Flows API

The Flows API installs flows between applications and DPEs, using the HTTP POST method. Refer to [Flows API](#) (HTTP GET) to view the list of parameters that can be specified to install a new flow.

The output for this message type displays the following information:

**Table 201: Flows API Output Parameters**

Output Parameter	Definition
flow-group-id	Flow-group in which the new flows are installed.
flows	List of new flows installed on the controller.
flow-id	ID of the new flow.
status	Status of flow installation.

The Flows API displays output similar to the example below:

```
#Install a single flow.
# curl --insecure -b "aruba-cookie" -d '{"flows": [{"switch": "00:00:00:1a:1e:00:3b:40",
"name":"sdn-1", "priority":32768, "ether-type":2048, "src-ip":"20.20.20.4", "dst-
ip":"20.20.20.5", "src-port":5000, "dst-port":8000, "protocol":17,
"actions":"output=controller,output=normal"}]}' https://10.4.251.105:4343/sdn/v1/flows |python
-mjson.tool
[
  {
    "Flow-Group-Id": 6269292156276441089,
```

```

    "Flows": [
      {
        "Flow-Id": 6269292156276441860
      }
    ],
    "Status": "Install-In-Progress"
  }
]

```

## Flow Update API

The Flow Update API updates the list of actions that are installed on an existing flow, using the HTTP POST method. See [Flow Match and Actions](#) for more information about match fields and actions.

**Table 202:** *Flow Update API Query Parameters*

Query Parameter	Definition
flow-group-id	Updates all flows associated with a specific flow-group ID.
flow-id	(Optional) Updates all flows associated with a specific flow ID. If this field is specified, only the flows that match both the flow-group ID and flow ID are updated.

The output for this message type displays the following information:

**Table 203:** *Flow Update API Output Parameters*

Output Parameter	Definition
flow-group-id	ID of the flow-group that is being updated.
flow-id	ID of the flow that is being updated.
status	Status of the flow update.

The Flow Update API displays output similar to the example below:

```

#curl --insecure -b "aruba-cookie" -d '{"flow-group-id":6269292156276441089, "flow-id":6269292156276441860, "actions":"output=controller"}'
https://10.4.251.105:4343/sdn/v1/flowupdate
{
  "flow-group-id": 6269292156276441089,
  "flow-id": 6269292156276441860,
  "status": "Install-In-Progress"
}

```

## Flow Delete API

The Flow Delete API deletes flows from the controller, using the HTTP POST method.

**Table 204:** *Flow Delete API Query Parameters*

Query Parameter	Definition
flow-group-id	Deletes all flows associated with a specific flow-group ID.
flow-group-id all	Deletes all flows in the network.

The output for this message type displays the following information:

**Table 205:** *Flow Delete API Output Parameters*

Output Parameter	Definition
status	Indicates if the flows for the given flow-group have been deleted.

The Flow Delete API displays output similar to the example below:

```
#curl --insecure -b "aruba-cookie" -d '{"flow-group-id":"6269292156276441090"}'
https://10.4.251.105:4343/sdn/v1/flowdelete |python -mjson.tool
{
  "Status": "Deleted"
}
```

## Error Messages

Error messages are returned if any SDN REST API experiences the following errors:

Error Message	Description
API-Timeout	The API times out.
Switch-Not-Reachable	The switch/DPE cannot be reached.
Switch-No-Reply	The switch/DPE does not reply to the request.
Db-Connect-Failed	The controller fails to connect to a database.
Out-of-Memory	The system runs out of memory.
Host-Not-Found	The host cannot be located.
Switch-Not-Found	The switch/DPE cannot be located.
Link-Not-Found	The link cannot be located.
Invalid-Input	The input is invalid.

Error Message	Description
Send-Failed	Northbound applications are unable to send data to internal applications.
Recv-Failed	Northbound applications are unable to receive data from internal applications.
Connect-Failed	Northbound applications are unable to connect to internal applications.
Bind-Failed	Northbound applications are unable to bind to the local address.
Socket-Failed	The socket connection fails.
Listen-Failed	Northbound applications are unable to listen for data from internal applications.
Accept-Failed	Northbound applications are unable to accept connections from internal applications.
Duplicate-Flow	The system encounters a duplicate flow.
Flow-Group-Not-Found	The flow-group cannot be located.
JSON-Parse-Error	The system experiences a JSON parsing error.
Flow-Conflict	The flow manager locates a conflicting entry in the Flow Database.
Switch-Internal-Error	The switch/DPE experiences an internal error.
Flow-Logical-Error	The system experiences an error in the flow logic.
Too-Many-Flows	Too many flows are being pushed in a single flow setup request.
Object-Id-Not-Found	The object ID cannot be located.
Object-Id-Invalid	The object ID is invalid.
Invalid-Group-Owner	The group owner is invalid.
Invalid-Action	The desired action is invalid.
System-Max-Flow-Limit-Reached	The system reaches the maximum flow limit.

## Asynchronous APIs

Asynchronous APIs are implemented through the ZeroMQ (ZMQ), which is a TCP-based open-source library that offers publish/subscribe services for server-to-client communication. Northbound applications subscribe to the desired topics based on the type of information that is required by the client. The controller publishes this information as events or packets. All ZMQ events, except 'packet-out' events, are published by the

Northbound API and sent to the respective northbound applications. The 'packet-out' events are published by the northbound applications and sent to the packetin-dispatcher on the controller. See [Packet Handling](#) for more information on packet processing.

The following ZMQ APIs are available on the SDN Controller:

**Table 206:** SDN ZMQ APIs

Event Type	Possible Values	Data Structure
Switch State Change (EVENT_SWITCH)	<ul style="list-style-type: none"> <li>STATE_UP</li> <li>STATE_DOWN</li> <li>STATE_UPDATE</li> </ul>	<pre>typedef struct {     uint16_t event;     uint16_t len; } event_header_t;  typedef struct {     uint64_t datapath_id;     uint8_t state;     uint8_t pad[7]; } switch_event_t;</pre>
Port State Change (EVENT_PORT)	<ul style="list-style-type: none"> <li>PORT_LINK_UP</li> <li>PORT_LINK_DOWN</li> </ul>	<pre>typedef struct {     uint16_t event;     uint16_t len; } event_header_t;  typedef struct {     uint64_t datapath_id;     uint32_t port_no;     uint8_t port_mac[ETH_ADDR_LEN];     uint8_t reason;     uint8_t state;     uint8_t pad[MAX_PORT_NAME_LEN]; } port_event_t;</pre>
Packet In	N/A	<pre>typedef struct {     uint64_t flow_id;     uint64_t datapath_id;     uint32_t port_no;     uint16_t vlan_vid;     uint16_t len; } zmq_pkt_in_t;</pre> <p>Followed by packet data</p>
Packet Out	N/A	<pre>typedef struct {     uint64_t datapath_id;     uint32_t port_no;     uint16_t len; } zmq_pkt_out_t;</pre> <p>Followed by packet data</p>
User Event	<ul style="list-style-type: none"> <li>USER_EVENT_ADD</li> <li>USER_EVENT_DELETE</li> <li>USER_EVENT_UPDATE</li> <li>USER_EVENT_IP_AGEOUT</li> </ul>	<pre>#define MAX_IP_ADDRS 4 typedef struct {     union {         uint32_t ipv4_addr;         struct in6_addr ipv6_addr;     }; };</pre>



Event Type	Possible Values	Data Structure
		<pre> bool is_ipv6; } ip_addr;  typedef struct sdn_host_t_ {     unsigned char mac[6];     uint64_t dpid;     uint32_t port;     bool wireless;     unsigned char port_mac[6];     ip_addr addrs[MAX_IP_ADDRS];     time_t updated_at;    time_t     created_at; } sdn_host_t;  typedef struct user_event_ {     uint8_t    event_type;     sdn_host_t host; } user_event_t; </pre>
Link Event	<ul style="list-style-type: none"> <li>● LINK_EVENT_ADD</li> <li>● LINK_EVENT_DELETE</li> <li>● LINK_EVENT_UPDATE</li> </ul>	<pre> typedef struct sdn_link_status_t_ {     uint64_t from_dpid;     uint64_t to_dpid;     uint32_t from_port;     uint32_t to_port;     uint8_t status; } sdn_link_status_t;  typedef struct link_event_ {     uint8_t event_type;     sdn_link_status_t link_status; } link_event_t; </pre>
Flow Event	<ul style="list-style-type: none"> <li>● FLOW_EVENT_DELETE</li> <li>● FLOW_EVENT_ERROR</li> <li>● FLOW_EVENT_ADD</li> <li>● FLOW_EVENT_UPDATE</li> </ul>	<pre> typedef struct flow_event_ {     uint64_t flow_group_id;     uint64_t flow_id;     uint8_t event_type; } flow_event_t; </pre>

## Northbound Authentication

To secure communication between users and APIs, the Northbound API supports basic authentication using HTTPS. During HTTPS authentication, the client is required to provide a username and password for each HTTPS request. The server can only carry out the request after the user is authenticated.

OpenFlow agent runs on network devices such as switches, routers, wireless controllers and APs. This interacts with a centralized SDN Controller using the OpenFlow protocol. The OpenFlow agent translates OpenFlow commands into device specific actions.

The three main functions of the OpenFlow agent are:

1. Discover the Hosts—Help the SDN Controller to discover all the hosts (endpoints) attached to Mobility Master.
2. Discover the Network—Help the SDN Controller to learn about the Mobility Master’s interface and its connectivity to other devices in the network.
3. Program the Network—Accept OpenFlow commands and take appropriate actions for those commands.
4. Provides Statistics—Provide visibility to SDN Controller to export flow/port statistics.

For OpenFlow to be functional in a network, you must enable SDN Controller on the Mobility Master and OpenFlow agent on the required Managed devices. By default, OpenFlow is disabled on Mobility Master as well as the managed devices.

## Enabling SDN Controller on Mobility Master

You can configure the SDN Controller using the WebUI or CLI.

### In the WebUI

The following procedure configures SDN Controller on Mobility Master using the WebUI:

1. In the **Mobility Master** node hierarchy, navigate to **Configuration > System > Profiles**.
2. In **All Profiles**, expand **Controller Profile**. Select **openflow-controller**.
3. In **openflow-controller**, select the **ofc-state** check box.



---

You can also configure an auxiliary channel port to reduce bandwidth consumption and latency on the main channel. To view the current status of the auxiliary channel, execute the **show openflow-controller switches** command. The default port is 6633. For more information on auxiliary channels, see [Auxiliary Channel Driver on page 842](#).

---

4. (Optional) To configure an auxiliary channel port, enter the listening port in the **ofc auxiliary-channel-port** field.
5. Click **Save**.
6. Click **Pending Changes**.
7. In the **Pending Changes** window, select the check box and click **Deploy changes**.

### In the CLI

Execute the following commands to enable SDN Controller on Mobility Master:

```
(host) [mm] (config) #openflow-controller
(host) [mm] (openflow-controller) #openflow-controller-enable
(host) [mm] (openflow-controller) #write memory
```



---

You can also configure an auxiliary channel port to reduce bandwidth consumption and latency on the main channel. To view the current status of the auxiliary channel, execute the **show openflow-controller switches** command. The default port is 6633. For more information on auxiliary channels, see [Auxiliary Channel Driver on page 842](#).

---

Execute the following command to configure and auxiliary channel port on the SDN Controller:

```
(host) [mm] (openflow-controller) #auxiliary-channel-port <port-num>
```

## Configuring OpenFlow Agent on Managed devices

To enable OpenFlow agent, you must perform the following tasks on the managed device:

1. Enable OpenFlow profile on the managed device.
  - a. Configure the SDN Controller IP address and listening port.
  - b. Bind the user VLAN.
2. Enable OpenFlow for the required user roles and Virtual APs.

### Enabling OpenFlow and Binding User VLAN

You can enable OpenFlow on the managed device and bind user VLAN using the WebUI or CLI:

#### In the WebUI

Follow the procedure below to configure the OpenFlow profile using the WebUI:

1. In the **Managed Networks** node hierarchy, navigate to **Configuration > System > Profiles**.
2. In **All Profiles**, expand **Controller Profile**. Select **Openflow-profile**.
3. In **Openflow-profile**, select the **State** check box.
4. (Optional) Select the **Auxiliary State** check box and enter the auxiliary port number in the **Auxiliary Channel Port** field to enable OpenFlow auxiliary channel port.



---

Ensure that the auxiliary channel port configured on the managed device matches with the one configured on Mobility Master. The default port is 6633.

---

5. In **controller-ip**, enter the Mobility Master IP address and port number.
6. In **bind-vlan**, enter the OpenFlow VLAN to the current list.
7. Click **Save**.
8. Click **Pending Changes**.
9. In the **Pending Changes** window, select the check box and click **Deploy changes**.

#### In the CLI

Execute the following commands to configure and enable the OpenFlow profile:

```
(host) [md] (config) #openflow-profile
(host) [md] (Openflow-profile) #openflow-enable
(host) [md] (Openflow-profile) #controller-ip <master-ip> <port>
```

Execute the following commands to configure an auxiliary channel port:

```
(host) [md] (Openflow-profile) #openflow-auxiliary-enable
(host) [md] (Openflow-profile) #auxiliary-channel-port <port>
```



---

Ensure that the auxiliary channel port configured on the managed device matches with the one configured on Mobility Master. The default port is 6633.

---

Execute the following command to bind user VLANs:

```
(host) [md] (Openflow-profile) #bind-vlan <list of vlan ids separated by comma>
(host) [md] (Openflow-profile) #write memory
```

## Enabling OpenFlow in User Role and Virtual AP

You can enable OpenFlow in user role and Virtual AP using the WebUI or CLI.

### In the WebUI

Follow the procedure below to enable OpenFlow in the user-role and virtual AP using the WebUI:

1. In the **Managed Network** node hierarchy, navigate to **Configuration > Roles & Policies**.
2. In the **Roles** tab, select an existing role.
3. In the **Roles > <custom-role>** section, click **Show Advanced View**.
4. Under **More**, expand **Network**.
5. In the **Open flow** drop-down list, select **Enabled**.
6. Click **Submit**.
7. Navigate to **Configuration > System > Profiles**.
8. In **All Profiles**, expand **Wireless LAN > Virtual AP**. Select the **default** profile.  
This procedure uses the *default* profile.
9. In **Virtual AP profile**, expand **Advanced**.
10. Select the **Openflow Enable** check box.
11. Click **Save**.
12. Click **Pending Changes**.
13. In the **Pending Changes** window, select the check box and click **Deploy changes**

### In the CLI

Execute the following commands to enable OpenFlow for a user role:

```
(host) [md] (config) #user-role <user-role>
(host) [md] (config-submode) #openflow-enable
(host) [md] (config-submode) #write memory
```

Execute the following commands to enable OpenFlow for a VAP:

```
(host) [md] (config) #wlan virtual-ap <virtual-ap>
(host) [md] (Virtual AP profile "<virtual-ap>") #openflow-enable
(host) [md] (Virtual AP profile "<virtual-ap>") #write memory
```

## Verifying OpenFlow Configuration on Managed Device

Execute the following commands to verify the OpenFlow profile configuration on the managed device:

```
(host) [md] #show openflow-profile
```

```
Openflow-profile "default"
```

```
-----
Parameter                               Value
-----
State                                    Enabled
Openflow mode                            passive
Openflow version                         v1.3
controller-ip                            10.16.125.115:6633
VLAN ID or range(s) of VLAN IDs         1,124,400,600
openflow tls                             Disabled
certificate-file                         none
key-file                                  none
ca-certificate-file                      none
```

## Verifying OpenFlow Configuration on Mobility Master

Execute the following command to verify the OpenFlow configuration on Mobility Master.

```
(host) [mynode] #show openflow-controller
```

```
openflow-controller
```

```
-----
```

Parameter	Value	Set
-----	-----	---
ofc state	Enabled	
ofc host-ageout-time	300	
ofc mode	passive	
ofc tls	Disabled	
ofc certificate-file	none	
ofc key-file	none	
ofc ca-certificate-file	none	
ofc port	6633	
ofc topology-discovery	Enabled	
ofc auxiliary-channel-port	6633	

## Viewing OpenFlow Information

The following show commands are used to view the OpenFlow related information:

- show openflow debug—Displays the OpenFlow debug information
- show openflow flows—Displays all the flows that are plumbed
- show openflow ports—Lists all the OpenFlow ports
- show openflow controller— Displays the OpenFlow Controller information
- show openflow capabilities —Displays the system capabilities
- show openflow flow-table— Displays the OpenFlow table
- show openflow statistics—Displays the OpenFlow statistics information
- show datapath openflow session/acl— Displays the session/ACL actions
- show datapath acl— Displays ACLs with OpenFlow index
- show ip access-list— Displays ACLs with action as OpenFlow

The Loadable Service Module (LSM) provides an infrastructure that allows users to dynamically upgrade or downgrade individual service modules without requiring an entire system reboot. Services are delivered as individual service packages containing the version and instructions for loading and running the service. LSM is introduced in ArubaOS 8.0.



---

ArubaOS 8.x does not support LSM in master controller mode.

---

This section includes the following topics:

- [Service Modules](#)
- [Service Packages](#)
- [Upgrading a Service Module](#)
- [Troubleshooting](#)

## Service Modules

The following service modules are LSM-capable, and the default service packages are bundled with the ArubaOS image:

- AirGroup
- AppRF
- ARM
- AirMatch
- NBAPI
- UCM
- WebCC
- WMS

## Service Packages

Every service module has a corresponding service package, which can be downloaded from the Aruba support site and installed on Mobility Master.

## Upgrading a Service Module

Service modules must be upgraded if there is a bug in the existing module or a newer version of the module has been released. Patches are posted to the [Aruba Support](#) site, where users can view and download packages to upgrade a service.



---

After an ArubaOS image upgrades or downgrades, the non-default service packages are deleted.

---

## In the WebUI

The following procedures upgrade a service module on Mobility Master using the WebUI.

### Downloading a Service Package

To download a service package through the WebUI:

1. Obtain the required service package from the Aruba Support site.
2. In the **Mobility Master** node-hierarchy, navigate to **Maintenance > Software Management > Service Module Packages** in the WebUI.
3. Click the **Add** button at the bottom of the **Service Module Packages** table to add a new service package.
4. Under **Load New Package**, select the **Access method** used to fetch the package. Configure the settings described in [Table 207](#).

**Table 207:** Load New Package Configuration Parameters

Parameter	Description
Access method	Select the protocol to send the service package from the image server to Mobility Master: <ul style="list-style-type: none"><li>• TFTP</li><li>• FTP</li><li>• SCP</li><li>• Local file</li></ul>
Host IP address	Enter the IP address of the image server where the service package resides.
Image file name	Enter the exact service package name as residing on the image server. <b>NOTE:</b> On selecting the <b>Local file</b> option from the <b>Access method</b> field, upload the service package from your local file explorer.
Destination file name	Enter the destination service package name. As a best practice, keep the image name same as destination file name.
Username	Enter the username of the image server. <b>NOTE:</b> This option is only available if you select the FTP or SCP protocol in the <b>Access method</b> field.
Password	Enter the password of the image server. <b>NOTE:</b> This option is only available if you select the FTP or SCP protocol in the <b>Access method</b> field.

5. Click **Submit** to validate the package.

### Activating the Service Package

To activate the service package through the WebUI:

1. In the **Mobility Master** node hierarchy, navigate to **Maintenance > Software Management > Service Module Packages**.
2. Select the new package from the **Service Module Packages** table. The **Service Module Packages > [name]** window appears at the bottom of the workscreen.

3. Set the **Status** to **Active** to activate the new service package.
4. Click **Submit**.

## Removing a Service Package

To remove a service package through the WebUI:

1. In the **Mobility Master** node hierarchy, navigate to **Maintenance > Software Management > Service Module Packages**.
2. Select a package from the **Service Module Packages** table. The **trash** icon for the highlighted package appears.
3. Click the **trash** icon. When the package delete window opens, click **Delete**.
4. Click **Submit**.

## In the CLI

Execute the following commands to upgrade a service module on Mobility Master using the CLI.

## Downloading a Service Package

Use one of the following CLI commands to download a service package through an FTP, SCP, or TFTP server:

```
(host) [mynode] #upgrade-pkg copy ftp: <ftphost> <username> <filename> flash: <destfilename>
```

```
(host) [mynode] #upgrade-pkg copy scp: <scphost> <username> <filename> flash: <destfilename>
```

```
(host) [mynode] #upgrade-pkg copy tftp: <tftphost> <filename> flash: <destfilename>
```

Upon download, the LSM performs the following compatibility checks to determine if the package is compatible with the running version of ArubaOS. If validation is successful, the installation process can continue. If validation is unsuccessful, the package is removed, and an error message appears.

- **Platform Check:** Determines if the package must run on a specific platform.
- **Version Check:** Determines if the package version matches the version of ArubaOS running on the system.

## Activating the Service Package

Use the following command to install and activate the service package through the CLI:

```
(host) [mynode] #upgrade-pkg activate <packagename>
```

The service is halted and upgraded with the new service package, during which time the service is unavailable to all users. After the new package is installed and activated, the service restarts.

## Viewing Service Packages

Execute the following command to display the downloaded and active LSM service packages on Mobility Master using the CLI:

```
(host) [mynode] #show packages
```

Packages that are not active can be removed using the **upgrade-pkg remove <packagename>** command.

## Removing a Service Package

Execute the following command to delete a service package from Mobility Master:

```
(host) [mynode] #upgrade-pkg remove <packagename>
```

# Troubleshooting

Execute the **show packages upgrade-history** command to view package installation logs:



```

(host) [mynode] #show packages upgrade-history
May 04 21:50:29 Copying files to airgroup dir
May 04 21:50:29 Creating symbolic link to mdns binary
May 04 21:50:29 Package default_airgroup_pkg installation was successfully
May 04 21:50:29 Copying files to ucm dir
May 04 21:50:29 Creating symbolic link to ucm binary
May 04 21:50:29 Package default_ucm_pkg installation was successfully
May 04 21:50:30 Copying files to wms dir
May 04 21:50:30 Creating symbolic link to wms binary
May 04 21:50:30 Package default_wms_pkg installation was successfully
May 04 21:50:30 Copying files to arm_cm dir
May 04 21:50:30 Creating symbolic link to arm binary
May 04 21:50:30 Package default_arm_cm_pkg installation was successfully
May 04 21:50:30 Copying files to web_cc dir
May 04 21:50:30 Creating symbolic link to web_cc binary
May 04 21:50:30 Package default_web_cc_pkg installation was successfully
May 04 21:50:30 Copying files to nbapi_helper dir
May 04 21:50:30 Creating symbolic link to nbapi_helper binary
May 04 21:50:30 Package default_nbapi_helper_pkg installation was successfully
May 04 21:50:31 Copying files to airmatch dir
May 04 21:50:31 Copying airmatch binary
May 04 21:50:31 Package default_airmatch_pkg installation was successfully
May 04 21:50:31 Copying files to appRF dir
May 04 21:50:31 Creating symbolic link to appRF binary

```

Execute the **show packages supported** command to view the packages supported on Mobility Master:

```

(host) [mynode] #show packages supported
Packages Supported
-----
Package Name  Version
-----
airgroup      1
ucm           1
wms          1
arm_cm       1
web_cc       1
nbapi_helper 1
airmatch     1
appRF        1

```

This chapter outlines the steps required to configure voice and video services on the Mobility Master for Voice over IP (VoIP) devices, including Apple FaceTime, Alcatel-Lucent New Office Environment (NOE), Microsoft® Lync/Skype for Business, Cisco Jabber, Cisco Skinny Call Control Protocol (SCCP), Spectralink SVP, SIP, H.323, Vocera, and Wi-Fi Calling. As video and voice applications are more vulnerable to delay and jitter, the network infrastructure must be able to prioritize video and voice traffic over data traffic.

This chapter includes the following topics:

- [Voice and Video License Requirements on page 874](#)
- [Configuring Voice and Video on page 874](#)
- [Working with QoS for Voice and Video on page 884](#)
- [Unified Communication and Collaboration on page 890](#)
- [Understanding Extended Voice and Video Features on page 931](#)

## Voice and Video License Requirements

The voice and video services require PEFNG licenses on the Mobility Master. For complete details on the required licenses, refer to the *Aruba Mobility Master Licensing Guide*.

## Configuring Voice and Video

This section describes the steps required to set up and configure voice features on the Mobility Master:

1. Set up net services
2. Configure roles
3. Configure firewall settings for voice and video ALGs
4. Configure other parameters depending on the need and environment



---

Assigning voice traffic to the high priority queue is recommended when deploying voice over WLAN networks.

---

### Voice ALG and Network Address Translation

Voice ALGs in Aruba Mobility Master do not support Network Address Translation (NAT). This is due to the way NAT functions and the way IP addresses are embedded in the signaling messages. In a typical customer deployment, a call server is deployed within an internal network which eliminates the need for NAT.

In short, voice ALGs should not be enabled when voice clients are behind a NAT.

### Setting up Net Services

You can either use the default net services and ports or you can create or modify net services.

#### Using Default Net Services

The following table lists the default net services and their ports:

**Table 208:** *Default Voice Net Services and Ports*

Net Service Name	Protocol	Port	ALG
svc-h323-tcp	TCP	1720	H.323
svc-h323-udp	UDP	1718, 1719	H.323
svc-noe	UDP	32512	NOE
svc-noe-oxo	UDP	5000	NOE
svc-sccp	TCP	2000	SCCP
svc-sips	TCP	5061	SIPS
svc-sip-tcp	TCP	5060	SIP
svc-sip-udp	UDP	5060	SIP
svc-svp	119	0	SVP
svc-vocera	UDP	5002	VOCE RA

## Creating Custom Net Services

You can use CLI to create or modify net services.

```
(host) [mynode] (config) #netservice
[service name] [protocol] [port] [alg]
```

To create an svc-noe service on UDP port 32522, enter:

```
(host) [mynode] (config) #netservice svc-noe udp 32522 alg noe
```

## Configuring User Roles

In the user-centric network, the user role of a wireless client determines its privileges and the type of traffic that it can send or receive in the wireless network. You can configure roles for clients that use mostly data traffic, such as laptops, and roles for clients that use mostly voice traffic, such as VoIP phones. Although there are different ways for a client to derive a user role, in most cases the clients using data traffic are assigned a role after they are authenticated through a method such as 802.1X, VPN, or captive portal. The user role for VoIP phones may also be derived from the Organizational Unit Identifier (OUI) of their MAC addresses or the SSID to which they associate. Refer to [Roles and Policies on page 367](#) for details on how to create and configure a user role.

This section describes how to configure voice user roles with the required privileges and priorities. Mobility Master provides default user roles for all voice services. You can do one of the following:

- Use default user roles
- Create or modify user roles

- Use user-derivation roles

## Using the Default User Role

Mobility Master is configured with the default voice role. This role has the following settings:

- No limit on upload or download bandwidth
- Default L2TP and PPTP pool
- Maximum sessions: 65535

The following ACLs are associated with the default voice role:

- global-sacl
- apprf-voice-sacl
- ra-guard
- sip-acl
- noe-acl
- svp-acl
- vocera-acl
- skinny-acl
- h323-acl
- dhcp-acl
- tftp-acl
- dns-acl
- icmp-acl
- http-acl
- https-acl
- skype4b-acl
- jabber-acl
- wificalling-acl
- voip-applications-acl

For more details on the default voice role, enter the following command in the Mobility Master:

```
(host) [mynode] #show rights voice
```

## Creating or Modifying Voice User Roles

You can create roles for Facetime, H.323, Jabber, NOE, SCCP, Skype for Business, SIP, SVP, Vocera, and Wi-Fi calling ALGs. Use the WebUI or CLI to configure user roles for any of the ALGs.

### In the WebUI

To configure user roles for ALGs:

1. In the **Managed Network** node hierarchy, navigate to **Configuration > Roles & Policies**.
2. In the **Policies** tab, click the + icon to add a policy.
3. For **Policy Name**, enter a name.
4. For **Policy Type**, select **Session**.
5. Click **Submit**.
6. Select the newly added policy.
7. In **Policies > <custom-policy>**, click the + icon to add a new rule.

8. Select **Access Control** option as the rule type.
9. Click **OK**.
10. Under **Roles**, configure the following settings:
  - a. For **IP version**, select **IPv4**.
  - b. For **Source**, select **any**.
  - c. For **Destination**, select **any**.
  - d. For **Service**, select service, then the correct voice or video ALG service. See [Table 209](#) and [Table 210](#) for service names for all ALGs:

**Table 209:** *Services for ALGs*

ALG	Service Name
NOE	<ul style="list-style-type: none"> <li>• svc-noe</li> <li>• sip-noe-oxo</li> </ul>
SIP	<ul style="list-style-type: none"> <li>• svc-sip-tcp</li> <li>• svc-sip-udp</li> </ul>
SIPS	svc-sips
SVP	svc-svp
VOCERA	svc-vocera
SCCP	svc-sccp
H.323	<ul style="list-style-type: none"> <li>• svc-h323-tcp</li> <li>• svc-h323-udp</li> </ul>

**Table 210:** *Other Services for the ALGs*

ACL	Service Name
DHCP	svc-dhcp
TFTP	svc-tftp
ICMP	svc-icmp
DNS	svc-dns

- e. For **Action**, select **permit**.
  - f. For **802.1p priority**, select a value. -- denotes lowest priority. 7 denotes highest priority.
  - g. Click **Submit**. Repeat steps 1 to 5 to add ACLs for more VoIP protocols.
11. Select the **Roles** tab. Click the + icon to add a user role.
12. In the **New Role** window, for **Name**, enter a name for the user role.

13. Click **Submit**.
14. Select the newly added role.
15. In the **Roles > <custom-role>** section, click **Show Advanced View**. Configure the following settings:
  - a. Under **Policies**, click the + icon.
  - b. In the **Add Policy** window, select the **Add an existing policy** option.
  - c. In the **Policy name** drop-down list, select the previously-configured policy name.
  - d. Click **Submit**.
  - e. Under **Policies**, click the + icon.
  - f. In the **Add Policy** window, select the **Add an existing policy** option.
  - g. In the **Policy name** drop-down list, select **control**.
  - h. Click **Submit**.
16. Click **Pending Changes**.
17. In the **Pending Changes** window, select the check box and click **Deploy changes**.

### In the CLI

To configure user roles for ALGs:

```
(host) [md] (config) #ip access-list session <policy-name>
(host) ^[md] (config-submode) #any any <service-name> permit queue high
```

To map the policy name to the user role:

```
(host) [md] (config) #user-role <role-name>
(host) ^[md] (config-submode) #access-list session <policy-name>
```

Replace the following strings:

- *policy-name* with a string that you want to identify the roles policy
- *role-name* with the name you want to identify the voice user role
- *service-name* with any of the service names from [Table 208](#)

### Using the User-Derivation Rules

The user role can be derived from attributes from the client's association with an AP. For VoIP phones, you can configure the devices to be placed in their user role based on the SSID or the OUI of the client's MAC address.




---

User-derivation rules are executed *before* the client is authenticated.

---

### In the WebUI

To derive a role based on SSID:

1. In the **Managed Network** node hierarchy, navigate to **Configuration > Authentication > User Rules**.
2. In **User Rules Summary**, click the + icon.
3. In the **Add New User Rule** window, enter a name for the user rule and click **Submit**.
4. In **User Rules Summary**, select the name of the user rule to configure the rule set.
5. In **Rules-set**, click the + icon and configure the following settings:
  - a. For **Set type**, select **Role** from the drop-down list.
  - b. For **Rule type**, select **ESSID**.
  - c. For **Condition**, select **equals**.
  - d. For **Value**, enter the SSID used for the phones.
  - e. For **Roles**, select the user role previously created.

6. Click **Submit**.
7. Click **Pending Changes**.
8. In the **Pending Changes** window, select the check box and click **Deploy changes**.

#### In the CLI

To derive a role based on SSID:

```
(host) [md] (config) #aaa derivation-rules user <name of rule-set>
(host) ^[md] (config-submode) #set role condition essid equals <ssid-name> set-value <The value that the role/VLAN should be set to>
```

#### In the WebUI

To derive a role based on MAC OUI:

1. In the **Managed Network** node hierarchy, navigate to **Configuration > Authentication > User Rules**.
2. In **User Rules Summary**, click the + icon.
3. In the **Add New User Rule** window, enter a name for the user rule and click **Submit**.
4. In **User Rules Summary**, select the name of the user rule to configure the rule set.
5. In **Rules-set**, click the + icon and configure the following settings:
  - a. For **Set type**, select **Role** from the drop-down list.
  - b. For **Rule type**, select **MAC Address**.
  - c. For **Condition**, select **contains**.
  - d. For **Value**, enter the first three octets (the OUI) of the MAC address of the phones (for example, the Spectralink OUI is 00:09:7a)
  - e. For **Roles**, select the user role previously created.
6. Click **Submit**.
7. Click **Pending Changes**.
8. In the **Pending Changes** window, select the check box and click **Deploy changes**.

#### In the CLI

To derive a role based on MAC OUI:

```
(host) [md] (config) #aaa derivation-rules user <name of rule-set>
(host) ^[md] (config-submode) #set role condition macaddr contains <xx:xx:xx:xx:xx:xx> set-value <The value that the role/VLAN should be set to>
```

## Additional Video Configurations

You can configure ArubaOS to reliably and efficiently stream video traffic over WLAN. This new method allows you to stream video traffic reliably without much distortion. To ensure that video data is transmitted reliably, dynamic multicast optimization techniques are used.

Although the dynamic multicast optimization conversion generates more traffic, that traffic is buffered by the AP and delivered to the client when the client emerges from power-save mode.

### Configuring Video over WLAN enhancements

To configure video over WLAN enhancements:

- Enable **WMM** in the WLAN SSID profile.
- Enable **IGMP** proxy or IGMP snooping in the interface VLAN.
- Configure an ACL to set a DSCP value same as the **wmm-vi-dscp** value in the WLAN SSID profile for prioritizing the multicast video traffic.
- Enable **dynamic multicast optimization** in the virtual AP profile.

- Configure the **dynamic multicast optimization threshold** in the virtual AP profile. The maximum number of high throughput stations in a multicast group. The optimization will stop if the number exceeds the threshold value.
- Enable **multicast rate optimization** in the WLAN SSID profile to support higher data rate for multicast traffic in the absence of dynamic multicast optimization. Dynamic multicast optimization takes precedence over multicast rate optimization up to the configured threshold value.




---

Configuring the **Video Multicast Rate Optimization** parameter overrides the configuration of **BC/MC Rate Optimization** parameter for VI-tagged multicast traffic. Multicast traffic that is not VI-tagged behaves the same with BC/MC as before. If multicast rate is not set, all traffic behaves the same.

---

- Enable **video aware scan** in the ARM profile. This ensures that AP does not scan when a video stream is active.
- Optionally, you can configure and apply the **WMM bandwidth management profile** in the virtual AP profile. The total bandwidth share should not exceed 100 percent.
- Enable **multicast shaping** in the WMM bandwidth management profile to shape the sudden traffic from the source.

### Prerequisites

- You will need the Policy Enforcement Firewall Next Generation (PEFNG) license to enable dynamic multicast optimization.

### In the WebUI

To configure video over WLAN enhancements:

1. Enable IGMP proxy or IGMP snooping on the managed device. To enable IGMP proxy:
  - a. In the **Managed Network** node hierarchy, navigate to **Configuration > Interfaces > VLANs**.
  - b. In **VLANs**, select an existing VLAN.
  - c. In **VLANs > <vlan-name>**, select an existing VLAN ID.
  - d. In the **IPv4** tab, expand **IGMP** and select **Enabled** from the **Enable IGMP** drop-down list.
  - e. In the **Enable IGMP proxy** drop-down list, select **Enabled**.
  - f. In the **Proxy interface** option, select **Interface Gigabitethernet** and the appropriate interface from the drop-down list.
  - g. Click **Submit**.
  - h. Click **Pending Changes**.
  - i. In the **Pending Changes** window, select the check box and click **Deploy changes**.

To enable IGMP snooping:

- a. In the **Managed Network** node hierarchy, navigate to **Configuration > Interfaces > VLANs**.
  - b. In **VLANs**, select an existing VLAN.
  - c. In **VLANs > <vlan-name>**, select an existing VLAN ID.
  - d. In the **IPv4** tab, expand **IGMP** and select **Enabled** from the **Enable IGMP** drop-down list.
  - e. In the **Enable IGMP snooping** drop-down list, select **Enabled**.
  - f. Click **Submit**.
  - g. Click **Pending Changes**.
  - h. In the **Pending Changes** window, select the check box and click **Deploy changes**.
2. Enable wireless multimedia and set a DSCP value for video traffic:
    - a. In the **Managed Network** node hierarchy, navigate to **Configuration > System > Profiles**.



- b. In **All Profiles**, expand **Wireless LAN > SSID**. Select the **default** profile.  
This example uses the *default* profile.
  - c. In **SSID Profile**, select the **Wireless Multimedia (WMM)** check box.
  - d. In the **DSCP mapping for WMM video AC (0-63)** field, enter the DSCP value (integer number).
  - e. Click **Save**.
  - f. Click **Pending Changes**.
  - g. In the **Pending Changes** window, select the check box and click **Deploy changes**.
3. Create an ACL on the managed device with the values equivalent to the DSCP mappings to prioritize the video traffic:
    - a. In the **Managed Network** node hierarchy, navigate to **Configuration > Roles & Policies**.
    - b. In the **Policies** tab, click the + icon to add a policy.
    - c. Enter the appropriate values in **Policies > <custom-policy>** to match the DSCP mapping values.
    - d. Click **Pending Changes**.
    - e. In the **Pending Changes** window, select the check box and click **Deploy changes**.

You can also add this ACL to any user role or port. To apply the ACL to a user role:

    - a. In the **Managed Network** node hierarchy, select the **Roles** tab and click the + icon to add a user role.
    - b. In the **New Role** window, for **Name**, enter a name for the user role.
    - c. Click **Submit**.
    - d. Select the newly added role.
    - e. In the **Roles > <custom-role>** section, click **Show Advanced View**. Configure the following settings:
    - f. Under **Policies**, click the + icon.
    - g. In the **Add Policy** window, select the **Add an existing policy** option.
    - h. In the **Policy name** drop-down list, select the previously-configured policy name.
    - i. Click **Submit**.
    - j. Click **Pending Changes**.
    - k. In the **Pending Changes** window, select the check box and click **Deploy changes**.

To apply the ACL to a port:

    - a. In the **Managed Network** node hierarchy, navigate to **Configuration > Interfaces > Ports**.
    - b. In **Ports**, select an upstream port.
    - c. Under the **VLAN Policy** drop-down list, select the ACL.
    - d. Click **Submit**.
    - e. Click **Pending Changes**.
    - f. In the **Pending Changes** window, select the check box and click **Deploy changes**.
4. Configure dynamic multicast optimization for video traffic on a virtual AP profile:
    - a. In the **Managed Network** node hierarchy, navigate to **Configuration > System > Profiles**.
    - b. In **All Profiles**, expand **Wireless LAN > Virtual AP**. Select the **default** profile.  
This example uses the *default* profile.
    - c. In **Virtual AP profile**, expand **Broadcast/Multicast**.
    - d. Select the **Dynamic Multicast Optimization (DMO)** check box.
    - e. Click **Save**.
    - f. Click **Pending Changes**.
    - g. In the **Pending Changes** window, select the check box and click **Deploy changes**.
  5. Configure multicast rate optimization for the video traffic:

- a. In the **Managed Network** node hierarchy, navigate to **Configuration > System > Profiles**.
- b. In **All Profiles**, expand **Wireless LAN > SSID**. Select the **default** profile.  
This example uses the *default* profile.
- c. In **SSID Profile**, select the **BC/MC Rate Optimization** check box.
- d. Select an option from the **Video Multicast Rate Optimization** drop-down list.
- e. Click **Save**.
- f. Click **Pending Changes**.
- g. In the **Pending Changes** window, select the check box and click **Deploy changes**.




---

Configuring the **Video Multicast Rate Optimization** parameter overrides the configuration of **BC/MC Rate Optimization** parameter for VI-tagged multicast traffic. Multicast traffic that is not VI-tagged behaves the same with BC/MC as before. If multicast rate is not set, all traffic behaves the same.

---

6. Configure ARM scanning for video traffic:
  - a. In the **Managed Network** node hierarchy, navigate to **Configuration > System > Profiles**.
  - b. In **All Profiles**, expand **RF Management > Adaptive Radio Management (ARM)**. Select the **default-a** profile.  
This example uses the *default-a* profile.
  - c. In **Adaptive Radio Management (ARM) profile**, expand **Scanning** and select the **VoIP Aware Scan** check box.
  - d. Click **Save**.
  - e. Click **Pending Changes**.
  - f. In the **Pending Changes** window, select the check box and click **Deploy changes**.
7. Configure and apply bandwidth management profile:
  - a. In the **Managed Network** node hierarchy, navigate to **Configuration > System > Profiles**.
  - b. In **All Profiles**, expand **QOS > WMM Traffic management**.
  - c. In **WMM Traffic management profile: New Profile**, enter the profile name, select the **Enable Shaping Policy** check box, and enter the bandwidth share values.
  - d. Click **Save**.
  - e. Click **Pending Changes**.
  - f. In the **Pending Changes** window, select the check box and click **Deploy changes**.

This step is optional.




---

Ensure that you configure the WMM traffic management profile to the virtual AP profile, if you have configured the virtual AP traffic management profile.

---

After you configure the WMM bandwidth management profile, apply it to the virtual AP profile.

8. Enable multicast shaping on the firewall:
  - a. In the **Managed Network** node hierarchy, navigate to **Configuration > Services > Firewall**.
  - b. In **Global Settings**, select **Enabled** from the **Multicast automatic shaping** drop-down list.
  - c. Click **Submit**.
  - d. Click **Pending Changes**.
  - e. In the **Pending Changes** window, select the check box and click **Deploy changes**.

## In the CLI

To configure the video over WLAN enhancements:

1. Enable IGMP proxy or IGMP snooping on the managed device.

To enable IGMP proxy:

```
(host) [md] (config) #interface vlan <id>
(host) ^[md] (config-submode)#ip igmp proxy gigabitethernet <slot/module/port>
```

To enable IGMP snooping:

```
(host) [md] (config) #interface vlan <id>
(host) ^[md] (config-submode)#ip igmp snooping
```

2. Enable wireless multimedia and set a DSCP value for video traffic:

```
(host) [md] (config)#wlan ssid-profile default
(host) ^[md] (SSID Profile "default")#wmm
(host) ^[md] (SSID Profile "default")#wmm-vi-dscp <value>
```

Setting the DSCP value tags the content as video stream that the APs can recognize.

3. Create an ACL on the managed device with the values equivalent to the DSCP mappings to prioritize video traffic. The following ACL prioritizes the multicast traffic from the specified multicast group on the managed device. You can also add this ACL to any user role or port:

```
(host) [md] (config) #ip access-list session mcast_video_acl

(host) ^[md] (config-submode
)#any network 224.0.0.0 255.0.0.0 any permit tos 40 queue high dot1p-priority 5
```

- a. To apply the ACL to a user role:

This example uses the user role *authenticated*.

```
(host) [md] (config) #user-role authenticated access-list session mcast_video_acl
```

- b. To apply the ACL to a port:

```
(host) [md] (config) #interface gigabitethernet <slot/module/port>
(host) ^[md] (config-submode)#ip access-group mcast_video_acl session
```

4. Configure dynamic multicast optimization for video traffic on a virtual AP profile:

```
(host) [md] (config)#wlan virtual-ap default
(host) ^[md] (Virtual AP Profile "default")#dynamic-mcast-optimization
```

5. Configure the dynamic multicast optimization threshold value:

```
(host) ^[md] (Virtual AP Profile "default")#dynamic-mcast-optimization-thresh 6
```

6. Configure multicast rate optimization for video traffic:

```
(host) [md] (config) #wlan ssid-profile default
(host) ^[md] (SSID Profile "default") #mcast-rate-opt
```

7. Configure ARM scanning for video traffic:

In the **rf arm-profile**, enable the **video-aware-scan** option. This prevents APs from scanning when a video traffic is active:

```
(host) [md] (config) #rf arm-profile default-a
(host) ^[md] (Adaptive Radio Management (ARM) profile "default-a") #video-aware-scan
```

8. Configure and apply a bandwidth management profile:

---

Ensure that you configure the WMM traffic management profile to the virtual AP profile, if you have configured the virtual AP traffic management profile.

---



- a. Enable a bandwidth shaping policy so that the allocated bandwidth share is appropriately used:

```
(host) [md] (config) #wlan wmm-traffic-management-profile default
(host) ^[md] (WMM Traffic management profile "default") # enable-shaping
```

- b. Set a bandwidth percentage for the following categories:

```
(host) ^[md] (WMM Traffic management profile "default") # background 10
(host) ^[md] (WMM Traffic management profile "default") # best-effort 20
(host) ^[md] (WMM Traffic management profile "default") # video 50
(host) ^[md] (WMM Traffic management profile "default") # voice 20
```

After you configure the WMM bandwidth management profile, apply it to the virtual AP profile:

```
(host) [md] (config) #wlan virtual-ap default
(host) ^[md] (Virtual AP profile "default") #wmm-traffic-management-profile default
```

#### 9. Enable multicast shaping on the firewall:

```
(host) [md] (config) #firewall
(host) ^[md] (config-submode) #shape-mcast
```

## Working with QoS for Voice and Video


Quality of Service (QoS) settings for voice and video applications are configured when you configure firewall roles and policies.

### Understanding Wi-Fi Multimedia

Wi-Fi Multimedia (WMM), is a Wi-Fi Alliance specification based on the IEEE 802.11e wireless QoS standard. WMM works with 802.11 a, b, g, n, and ac physical layer standards.

WMM supports four access categories (ACs); voice, video, best effort, and background. [Table 211](#) shows the mapping of the WMM access categories to 802.1p priority values. The 802.1p priority value is contained in a two-byte QoS control field in the WMM data frame.

**Table 211:** WMM Access Category to 802.1p Priority Mapping

Priority	802.1p Priority	WMM Access Category
	1	Background
	2	Best effort
	0	
	3	Video
	4	
	5	
	6	Voice
7		
Highest		

In non-WMM, or hybrid environments where some clients are not WMM-capable, ArubaOS uses voice and best effort to prioritize traffic from these clients. Unscheduled Automatic Power Save Delivery (U-APSD) is a component of the IEEE 802.11e standard that extends the battery life on voice over WLAN devices. When enabled, clients trigger the delivery of buffered data from the AP by sending a QoS data or QoS null data frame. For the environments in which the wireless clients support WMM, you can enable both WMM and U-APSD in the SSID profile.

## Enabling WMM

You can use the WebUI or CLI to enable WMM for wireless clients.

### In the WebUI

To enable WMM for wireless clients:

1. In the **Managed Network** node hierarchy, navigate to **Configuration > System > Profiles**.
2. In **All Profiles**, expand **Wireless LAN > Virtual AP > default > SSID**.  
This example uses the *default* profile.
3. In **SSID Profile**, select the **Wireless Multimedia (WMM)** check box. Or, select the **Wireless Multimedia U-APSD (WMM-UAPSD) Powersave** check box if you want to enable WMM in power save mode.
4. Click **Save**.
5. Click **Pending Changes**.
6. In the **Pending Changes** window, select the check box and click **Deploy changes**.

### In the CLI

To enable WMM for wireless clients:

```
(host) [md] (config) #wlan ssid-profile default
(host) ^[md] (SSID Profile "default") #wmm
(host) ^[md] (SSID Profile "default") #wmm-uapsd
```

## Configuring WMM AC Mapping

The IEEE 802.11e standard defines the mapping between WMM ACs and Differentiated Services Code Point (DSCP) tags. The WMM AC mapping commands allow you to customize the mapping between WMM ACs and DSCP tags to prioritize various traffic types. You apply and configure WMM AC mappings to a WMM-enabled SSID profile.

DSCP classifies packets based on network policies and rules, not priority. The configured DSCP value defines per hop behaviors (PHBs). The PHB is a 6-bit value added to the 8-bit Differentiated Services (DS) field of the IP packet header. The PHB defines the policy and service applied to a packet when traversing the network. You configure these services in accordance with your network policies. [Table 212](#) shows the default WMM AC to DSCP decimal mappings and the recommended WMM AC to DSCP mappings.

**Table 212:** WMM Access Category to DSCP Mappings

DSCP Decimal Value	WMM Access Category
8	Background
16	
0	Best effort
24	
32	Video

DSCP Decimal Value	WMM Access Category
40	
48	Voice
56	

By customizing WMM AC mappings, both the managed device and AP maintain a customized WMM AC mapping table for each configured SSID profile. All packets received are matched against the entries in the mapping table and prioritized accordingly. The mapping table contains information for both upstream (client to AP) and downstream (AP to client) traffic.

When planning your mappings, make sure that any immediate switch or router does not have conflicting 802.1p or DSCP configuration or mapping. If this occurs, your traffic may not be prioritized correctly.

To view the mapping settings, execute the following command:

```
(host) [mynode] #show wlan ssid-profile <profile>
```

### In the WebUI

To map WMM AC with DSCP:

1. In the **Managed Network** node hierarchy, navigate to **Configuration > System > Profiles**.
2. In **All Profiles**, expand **Wireless LAN > Virtual AP > default > SSID**. This example uses the *default* profile.
3. In **SSID Profile**, select the **Wireless Multimedia (WMM)** check box.
4. Modify the DSCP mapping settings, as needed:
  - **DSCP mapping for WMM voice AC (0-63)**—DSCP map for voice traffic
  - **DSCP mapping for WMM video AC (0-63)**—DSCP map for video traffic
  - **DSCP mapping for WMM best-effort AC (0-63)**—DSCP map for best-effort traffic
  - **DSCP mapping for WMM background AC (0-63)**—DSCP map for background traffic
5. Click **Save**.
6. Click **Pending Changes**.
7. In the **Pending Changes** window, select the check box and click **Deploy changes**.

### In the CLI

To map WMM AC with DSCP:

```
(host) [md] (config) #wlan ssid-profile <profile>
(host) ^[md] (SSID Profile "default") #wmm-be-dscp <wmm-be-dscp>
(host) ^[md] (SSID Profile "default") #wmm-bk-dscp <wmm-bk-dscp>
(host) ^[md] (SSID Profile "default") #wmm-vi-dscp <wmm-vi-dscp>
(host) ^[md] (SSID Profile "default") #wmm-vo-dscp <wmm-vo-dscp>
```

The WMM-DSCP mapping functionality has the following features:

- Default mappings are not there for a newly created SSID profile and for a factory default managed device running an ArubaOS 8.0 image.
- If the mapping has no value, the original DSCP for upstream traffic is retained.
- The maximum number of values that can be configured for WMM-DSCP is 8.
- For the upstream traffic, if the mapping exists and incoming DSCP value matches one of the mapped values, then the DSCP value is retained.

- For the upstream traffic, if the mapping exists and incoming DSCP value does not match any of the mapped values, then the DSCP value is overwritten with the first value in the WMM-DSCP list
- For wireless-to-wireless traffic, if the AC of the incoming packet has no mapping and the incoming DSCP value is mapped to a different AC, then the DSCP value is retained and WMM priority is changed to the corresponding AC where incoming DSCP is mapped.

## Configuring DSCP Priorities

You can configure DSCP priorities for WMM packets in the following ways:

- Configure the DSCP mappings in the SSID profile
- Set a ToS value in the ACL
- Set the ToS value and the 802.1p priority in the ACL

Setting a ToS value in the ACL overrides the default DSCP mappings configured in the SSID profile. Configuring a DSCP priority in both the L2 and L3 header prioritizes the WMM packets with the higher value. For example, you can have different ToS values set for different voice traffic in a network. To prioritize all of them in the voice queue, we can set the 802.1p priority to voice.

Consider a deployment where Cisco Softphone, Microsoft Skype for Business, and Avaya Scopia are configured with the following DSCP :

- Cisco Softphone - DSCP 46
- Microsoft Skype for Business - DSCP 44
- Avaya Scopia - DSCP 42

In the absence of doing anything, all of the DSCP above would map into the video queue. To map all the traffic into voice queue, you can use the following ACL configuration:

```
(host) [md] (config) #wlan ssid-profile VOICE

(host) ^[md] (SSID Profile "VOICE") #wmm-vo-dscp 46

(host) ^[md] (SSID Profile "VOICE") #!
(host) ^[md] (config) #ip access-list session VOICE

(host) ^[md] (config-submode)#any destination <SKYPE4B_SERVER> <SKYPE4B_PORTS> permit tos 44
dot1p-priority 6

(host) ^[md] (config-submode)#any destination [SCOPIA_SERVER] [SCOPIA_PORTS] permit tos 42
dot1p-priority 6
```



NOTE

---

You must know the ports on which each traffic is sent so that the correct traffic is identified.

---

## Configuring Dynamic WMM Queue Management

Traditional wireless networks provide all clients with equal bandwidth access. However, delays or reductions in throughput can adversely affect voice and video applications, resulting in disrupted VoIP conversations or dropped frames in a streamed video. Thus, data streams that require strict latency and throughput need to be assigned higher traffic priority than other traffic types.

The Wi-Fi Alliance defined the Wi-Fi Multimedia (WMM) standard in response to industry requirements for QoS support for multimedia applications for wireless networks. This is defined as per the IEEE 802.11e standards.

WMM requires:

- the access point be Wi-Fi Certified and has WMM enabled
- the client device be Wi-Fi Certified
- the application support WMM

## Enhanced Distributed Channel Access

WMM provides media access prioritization through Enhanced Distributed Channel Access (EDCA). EDCA defines four ACs to prioritize traffic; voice, video, best effort, and background. These ACs correspond to 802.1p priority tags, as shown in [Table 213](#).

**Table 213:** WMM Access Categories and 802.1p Tags

WMM Access Category	Description	802.1p Tag
Voice	Highest priority	7, 6
Video	Prioritize video traffic above other data traffic	5, 4
Best Effort	Traffic from legacy devices or traffic from applications or devices that do not support QoS	0, 3
Background	Low priority traffic (file downloads, print jobs)	2, 1

While the WMM ACs designate specific types of traffic, you can determine the priority of the ACs. For example, you can choose to give video traffic the highest priority. With WMM, applications assign data packets to an AC. In the client, the data packets are then added to one of the transmit queues for voice, video, best effort, or background.

WMM is an extension to the Carrier Sense Multiple Access with Collision Avoidance (CSMA/CA) protocol's Distributed Coordination Function (DCF). The collision resolution algorithm responsible for traffic prioritization depends on the following configurable parameters for each AC:

- arbitrary inter-frame space number (AIFSN)
- minimum and maximum contention window (CW) size

For each AC, the backoff time is the sum of the AIFSN and a random value between 0 and the CW value. The AC with the lowest backoff time is granted the opportunity to transmit (TXOP). Frames with the highest-priority AC are more likely to get TXOP, because they tend to have the lowest backoff times (a result of having smaller AIFSN and CW parameter values). The value of the CW varies through time as the CW doubles after each collision up to the maximum CW. The CW is reset to the minimum value after successful transmission. In addition, you can configure the TXOP duration for each AC.

On the managed device, you configure the AC priorities in the WLAN EDCA parameters profile. There are two sets of EDCA profiles you can configure:

- AP parameters affecting traffic from the AP to the client.
- STA parameters affecting traffic from the client to the AP.

### Configure EDCA parameters

Use the following procedure to define an Enhanced Distributed Channel Access (EDCA) profile for APs or for clients (stations).

1. In the **Managed Network** node hierarchy, navigate to **Configuration > System > Profiles**.
2. In **All Profiles**, expand **Wireless LAN > SSID > default**.  
This example uses the *default* profile.
3. Select the **EDCA Parameters Station** or **EDCA Parameters AP** profile. Configure the EDCA profile based on the parameters described in [Table 214](#).
4. Click **Save**.



5. Click **Pending Changes**.
6. In the **Pending Changes** window, select the check box and click **Deploy changes**.

**Table 214:** EDCA Parameters Station and EDCA Parameters AP Profile Settings

Parameter	Description
Best Effort	<p>Set the following parameters to define the best effort queue:</p> <ul style="list-style-type: none"> <li>● <b>aifsn</b>: arbitrary inter-frame space number. Range: 1-15.</li> <li>● <b>ecw-max</b>: the exponential (n) value of the maximum contention window size, as expressed by <math>2^n-1</math>. A value of 4 computes to <math>2^4-1 = 15</math>. Range: 1-15.</li> <li>● <b>ecw-min</b>: the exponential (n) value of the minimum contention window size, as expressed by <math>2^n-1</math>. A value of 4 computes to <math>2^4-1 = 15</math>. Range: 0-15.</li> <li>● <b>txop</b>: transmission opportunity, in units of 32 microseconds. Divide the desired transmission duration by 32 to determine the value to configure. For example, for a transmission duration of 3008 microseconds, enter 94 (3008/32). Range: 0-2047.</li> <li>● <b>acm</b>: this parameter specifies mandatory admission control. With a value of <b>1</b>, the client reserves the access category through traffic specification (TSPEC) signaling. A value of <b>0</b> disables this option.</li> </ul>
Background	<p>Set the following parameters to define the background queue:</p> <ul style="list-style-type: none"> <li>● <b>aifsn</b>: arbitrary inter-frame space number. Range: 1-15.</li> <li>● <b>ecw-max</b>: the exponential (n) value of the maximum contention window size, as expressed by <math>2^n-1</math>. A value of 4 computes to <math>2^4-1 = 15</math>. Range: 1-15.</li> <li>● <b>ecw-min</b>: the exponential (n) value of the minimum contention window size, as expressed by <math>2^n-1</math>. A value of 4 computes to <math>2^4-1 = 15</math>. Range: 0-15.</li> <li>● <b>txop</b>: transmission opportunity, in units of 32 microseconds. Divide the desired transmission duration by 32 to determine the value to configure. For example, for a transmission duration of 3008 microseconds, enter 94 (3008/32). Range: 0-2047.</li> <li>● <b>acm</b>: this parameter specifies mandatory admission control. With a value of <b>1</b>, the client reserves the access category through traffic specification (TSPEC) signaling. A value of <b>0</b> disables this option.</li> </ul>
Video	<p>Set the following parameters to define the background queue:</p> <ul style="list-style-type: none"> <li>● <b>aifsn</b>: arbitrary inter-frame space number. Range: 1-15.</li> <li>● <b>ecw-max</b>: The exponential (n) value of the maximum contention window size, as expressed by <math>2^n-1</math>. A value of 4 computes to <math>2^4-1 = 15</math>. Range: 1-15.</li> <li>● <b>ecw-min</b>: the exponential (n) value of the minimum contention window size, as expressed by <math>2^n-1</math>. A value of 4 computes to <math>2^4-1 = 15</math>. Range: 0-15.</li> <li>● <b>txop</b>: transmission opportunity, in units of 32 microseconds. Divide the desired transmission duration by 32 to determine the value to configure. For example, for a transmission duration of 3008 microseconds, enter 94 (3008/32). Range: 0-2047.</li> <li>● <b>acm</b>: this parameter specifies mandatory admission control. With a value of <b>1</b>, the client reserves the access category through traffic specification (TSPEC) signaling. A value of <b>0</b> disables this option.</li> </ul>
Voice	<p>Set the following parameters to define the background queue:</p>

Parameter	Description
	<ul style="list-style-type: none"> <li>• <b>aifsn</b>: trbitrary inter-frame space number. Range: 1-15.</li> <li>• <b>ecw-max</b>: the exponential (n) value of the maximum contention window size, as expressed by <math>2^n-1</math>. A value of 4 computes to <math>2^4-1 = 15</math>. Range: 1-15.</li> <li>• <b>ecw-min</b>: the exponential (n) value of the minimum contention window size, as expressed by <math>2^n-1</math>. A value of 4 computes to <math>2^4-1 = 15</math>. Range: 0-15.</li> <li>• <b>txop</b>: transmission opportunity, in units of 32 microseconds. Divide the desired transmission duration by 32 to determine the value to configure. For example, for a transmission duration of 3008 microseconds, enter 94 (3008/32). Range: 0-2047.</li> <li>• <b>acm</b>: this parameter specifies mandatory admission control. With a value of <b>1</b>, the client reserves the access category through traffic specification (TSPEC) signaling. A value of <b>0</b> disables this option.</li> </ul>

### Configure EDCA Profile

Use the following procedure to define an Enhanced Distributed Channel Access (EDCA) profile for APs or for clients (stations).

```
(host) [md] (config) #wlan edca-parameters-profile {ap|station} <profile>
(host) ^[md] (EDCA Parameters profile (AP) "default") #{background|best-effort|video|voice}
[acm][aifsn <number>] [ecw-max <exponent>] [ecw-min <exponent>] [txop <number>]
```

To associate the EDCA profile instance to a SSID profile:

```
(host) [md] (config) #wlan ssid-profile <profile>
(host) ^[md] (SSID Profile "<profile>") #edca-parameters-profile {ap|sta} <profile>
```

## Unified Communication and Collaboration

This section describes the Unified Communication and Collaboration (UCC) feature. The Unified Communications Manager (UCM) is the core solution component of this feature. UCC addresses the onslaught of mobile devices that use voice, video, and collaboration applications. UCC solution reduces the cost of infrastructure for enterprise communication and collaboration.

UCC continues to support most of the existing functionality offered by ArubaOS 6.x. This section includes the following topics:

- [UCC Application in ArubaOS 8.x on page 891](#)
- [UCC Value Additions in Mobility Master on page 891](#)
- [UCC in Master Controller Mode on page 891](#)
- [UCC Changes from ArubaOS 6.x on page 891](#)
- [UCC Features Deprecated in ArubaOS 8.x on page 892](#)
- [Prerequisites to Enable UCC on page 892](#)
- [Multi-ALG Support on page 896](#)
- [UCC ALG Configuration](#)
- [View UCC Information on page 898](#)
- [Intelligent Call Handling on page 898](#)
- [RTP Analysis on page 899](#)
- [AppRF Integration with ALGs and User Role on page 901](#)
- [Microsoft® Lync/Skype for Business on page 903](#)
- [Cisco Jabber on page 914](#)

- [Wi-Fi Calling on page 919](#)
- [UCC Dashboard on page 923](#)
- [UCC-AirWave Integration on page 928](#)
- [UCC Limitations on page 930](#)
- [Upgrade UCM Loadable Service Module on page 931](#)

## UCC Application in ArubaOS 8.x

Starting from ArubaOS 8.x, UCM runs as a loadable service module on Mobility Master. UCC supports various applications like Apple FaceTime, Alcatel-Lucent New Office Environment (NOE), Microsoft® Lync/Skype for Business, Cisco Jabber, Cisco Skinny Call Control Protocol (SCCP), SpectraLink Voice Priority (SVP), SIP, H.323, Vocera, and Wi-Fi Calling. UCC application on Mobility Master implements the VoIP Application Layer Gateway (ALG) to support both encrypted and non-encrypted VoIP protocols. UCC application uses the OpenFlow infrastructure to receive the signaling messages from the managed devices and also install and delete flows on the managed devices for calls made.

In addition, UCC is supported on a stand-alone and master controller. In master controller mode, UCM and VoIP ALGs run on the managed devices.

## UCC Value Additions in Mobility Master

The following is a list of UCC value additions in Mobility Master:

- Enables VoIP ALGs to run as a service on Mobility Master and managed devices need not run the same. This results in better scalability.
- Enables real-time analysis of VoIP calls in upstream direction. This is the real-time analysis and UCC call quality statistics calculated based on VoIP stream captured at the managed device.
- Supports Loadable Service Module. UCM is a Loadable Service Module. ALGs are completely decoupled from the managed devices. This enables faster innovation of VoIP services such as introduction of new ALGs and enhancements to existing features as they will become independent of the ArubaOS release version.
- Provides a solution to the fanout problem in Lync/Skype for Business SDN API. In ArubaOS 6.x, Lync/Skype for Business SDN Manager sent call information messages to every local controller in the network, regardless of whether the local controller is involved in the call or not. This additional processing is an unnecessary overhead on the local controller. In addition, the bandwidth utilization between the data center and remote location is not efficient. With the Mobility Master deployment, Lync/Skype for Business SDN Manager sends the call information messages to Mobility Master only.
- Provides aggregation of statistical information of call-related data at a centralized entity.

## UCC in Master Controller Mode

ArubaOS 8.x.1.0 supports 7200 Series controllers to run as a master controller. UCC is supported in master controller mode. In master controller mode, UCM and VoIP ALGs run on the managed device. The ALGs should be configured on the managed device. OpenFlow infrastructure is not supported in master controller mode. Centralized visibility of UCC statistics is not available in this mode. To view the UCC statistics, you should log in to the respective managed device.

## UCC Changes from ArubaOS 6.x

The following is a list of UCC changes from ArubaOS 6.x to ArubaOS 8.x:

- In ArubaOS 6.x, VoIP ALGs run on the respective local controllers that parse the signaling messages, dynamically opens sessions in firewall, prioritizes traffic, and provide visibility. In ArubaOS 8.x, VoIP ALGs do not run on the managed devices. They run as an application on Mobility Master. In a stand-alone controller

deployment, the VoIP ALGs run on the stand-alone controller itself. In master controller mode, the VoIP ALGs run on respective managed devices.

- UCC running on Mobility Master uses OpenFlow infrastructure to receive signaling packets on Mobility Master, parse, open sessions in the firewall, and prioritize them. In master controller mode, OpenFlow infrastructure is not supported.
- Visibility for all supported UCC applications are provided from the centralized Mobility Master dashboard. Centralized dashboard and visibility are not available in master controller mode. You should login to individual managed device to view dashboard information.
- ArubaOS 8.x supports Cisco Jabber and Wi-Fi Calling.
- Unlike ArubaOS 6.X, where ALGs use Wi-Fi Multimedia-Differentiated Services Code Point (WMM-DSCP) mappings in the WLAN SSID profile to set the Type of Service (ToS) for Real-time Transport Protocol (RTP) and Real-time Transport Control Protocol (RTCP), Mobility Master has ALG-specific Quality of Service (QoS) configurations.

## UCC Features Deprecated in ArubaOS 8.x

The following are the features deprecated in ArubaOS 8.x:

- Basic Service Set (BSS) transition and force BSS transition.
- Call count, bandwidth, and Traffic Specification (TSPEC)-based call admission control.
- Classify media action in ACL for media classification – Microsoft® Lync/Skype for Business calls will automatically get prioritized without the need for classify media ACLs.
- SIP session timer.
- SIP dial plans.
- WMM-DSCP override setting in the SSID profile.
- Stateful ALG settings in global firewall options. These settings are now available in Mobility Master and master controller under the **Configuration > System > Profiles > All Profiles > UCC** profile.
- Lync/Skype for Business traffic control profile.
- Web Server port configuration for Lync/Skype for Business SDN API. The Mobility Master and master controller uses 32000 as the default port now.
- The **Monitoring** tab in the WebUI.
- The **show voice** commands.
- **sip-authentication-role** parameter in AAA profile.
- **voice-aware** parameter in AAA authentication 802.1X profile.

## Prerequisites to Enable UCC

### OpenFlow Controller Configuration

Enable OpenFlow on Mobility Master. You must enable this in the **/mm** node hierarchy.



---

OpenFlow controller is not a prerequisite in master controller mode.

---

### In the WebUI

The following procedure configures OpenFlow on Mobility Master using the WebUI:

1. In the **Mobility Master** node hierarchy, navigate to **Configuration > System > Profiles**.
2. In **All Profiles**, expand **Controller Profile**. Select **openflow-controller**.
3. In **openflow-controller**, select the **ofc-state** check box.

4. Click **Save**.
5. Click **Pending Changes**.
6. In the **Pending Changes** window, select the check box and click **Deploy changes**.

#### In the CLI

The following commands configure OpenFlow on Mobility Master using the CLI:

```
(host) [mm] (config) #openflow-controller
(host) ^[mm] (openflow-controller) #openflow-controller-enable
(host) ^[mm] (openflow-controller) #write memory
```

### OpenFlow Profile Configuration on Managed Devices

Bind the user VLANs to the OpenFlow profile on the managed devices. You must bind this in the **/md** node hierarchy.



---

OpenFlow profile is not a prerequisite in master controller mode.

---

#### In the WebUI

The following procedure binds the user VLANs to the OpenFlow profile on the managed devices using the WebUI:

1. In the **Managed Network** node hierarchy, navigate to **Configuration > System > Profiles**.
2. In **All Profiles**, expand **Controller Profile**. Select **Openflow-profile**.
3. In **Openflow-profile**, select the **State** check box.
4. In **controller-ip**, enter the Mobility Master IP address and port number.
5. In **bind-vlan**, enter the user VLAN to the current list.
6. Click **Save**.
7. Click **Pending Changes**.
8. In the **Pending Changes** window, select the check box and click **Deploy changes**.

#### In the CLI

The following commands bind the user VLANs to the OpenFlow profile on the managed devices using the CLI:

```
(host) [md] (config) #openflow-profile
(host) ^[md] (Openflow-profile) #openflow-enable
(host) ^[md] (Openflow-profile) #controller-ip <MM-ip> <port>
(host) ^[md] (Openflow-profile) #bind-vlan <list of user vlans>
(host) ^[md] (Openflow-profile) #write memory
```

### OpenFlow in User Role and Virtual AP Configuration

Enable OpenFlow in the user-role and the virtual AP profile. You must enable this in the **/md** node hierarchy.



---

OpenFlow in user role and virtual AP is not a prerequisite in master controller mode.

---

#### In the WebUI

The following procedure enables OpenFlow in the user-role and virtual AP using the WebUI:

1. In the **Managed Network** node hierarchy, navigate to **Configuration > Roles & Policies**.
2. In the **Roles** tab, select an existing role.
3. In the **Roles > <custom-role>** section, click **Show Advanced View**.

4. Under **More**, expand **Network**.
5. In the **Open flow** drop-down list, select **Enabled**.
6. Click **Submit**.
7. Navigate to **Configuration > System > Profiles**.
8. In **All Profiles**, expand **Wireless LAN > Virtual AP**. Select the **default** profile.  
This example uses the *default* profile.
9. In **Virtual AP profile**, expand **Advanced**.
10. Select the **Openflow Enable** check box.
11. Click **Save**.
12. Click **Pending Changes**.
13. In the **Pending Changes** window, select the check box and click **Deploy changes**.

### In the CLI

The following commands enable OpenFlow in the user-role and virtual AP using the CLI:

```
(host) [md] (config) #user-role <user-role>
(host) ^[md] (config-submode) #openflow-enable
(host) ^[md] (config-submode) #!
(host) ^[md] (config) #wlan virtual-ap <virtual-ap>
(host) ^[md] (Virtual AP profile "<virtual-ap>") #openflow-enable
(host) ^[md] (Virtual AP profile "<virtual-ap>") #write memory
```

## Management Server Profile Configuration

Configure the management server profile. This enables AMON feeds to be sent to Mobility Master or master controller for various statistics. You must configure this in the **/md** node hierarchy or the sub-nodes of **/md**.

### In the WebUI

The following procedure configures management server profile using the WebUI:

1. In the **Managed Network** node hierarchy, navigate to **Configuration > System > Profiles**.
2. In **All Profiles**, expand **Controller Profile**. Select **Mgmt Config**.
3. In **Mgmt Config profile**, click the + icon.
4. In the **Profile name** field, enter the name of the management server profile.
5. Select the following check boxes:
  - **Stats**
  - **Sessions**
  - **Monitored Info - Add/Update**
  - **Monitored Info - Deletion**
  - **Monitored Info - Periodic Snapshot**
6. Click **Save**.
7. Navigate to **Configuration > System > More**.
8. In **MON Receivers**, click the + icon.
9. In **New MON Receivers**, enter the following details:
  - a. In the **Server** field, enter the Mobility Master or master controller IP address.
  - b. In the **Profile list** drop-down list, select the newly created management server profile.
10. Click **Submit**.
11. Click **Pending Changes**.
12. In the **Pending Changes** window, select the check box and click **Deploy changes**.

## In the CLI

The following commands configure management server profile using the CLI:

```
(host) [md] (config) #mgmt-server profile <profile-name>
(host) ^[md] (Mgmt Config profile "<profile-name>") #stats-enable
(host) ^[md] (Mgmt Config profile "<profile-name>") #sessions-enable
(host) ^[md] (Mgmt Config profile "<profile-name>") #monitored-info-enable
(host) ^[md] (Mgmt Config profile "<profile-name>") #monitored-info-del-enable
(host) ^[md] (Mgmt Config profile "<profile-name>") #monitored-info-snapshot-enable
(host) ^[md] (Mgmt Config profile "<profile-name>") #!
(host) ^[md] (config) #mgmt-server primary-server <MM-IP> profile <profile-name>
(host) ^[md] (config) #write memory
```

## Deep Packet Inspection Configuration

Enable Deep Packet Inspection (DPI) on the managed devices if your deployment has Cisco Jabber clients. You must enable this in the **/md** node hierarchy.

### In the WebUI

The following procedure enables DPI on the managed devices using the WebUI:

1. In the **Managed Network** node hierarchy, navigate to **Configuration > Services > Firewall**.
2. Expand **Global Settings**.
3. In the **Enable deep packet inspection** drop-down list, select **Enabled**.
4. Click **Submit**.
5. Click **Pending Changes**.
6. In the **Pending Changes** window, select the check box and click **Deploy changes**.

### In the CLI

The following commands enable DPI on the managed devices using the CLI:

```
(host) [md] (config) #firewall
(host) ^[md] (config-submode) #dpi
(host) ^[md] (config) #write memory
```



---

If DPI is enabled, either there should be an explicit ACL to permit RTP/RTCP traffic or an app-based ACL to permit media traffic. For more information, see [AppRF Integration with ALGs and User Role on page 901](#).

---

## Firewall Visibility Configuration

Enable firewall visibility on the managed devices. This is an optional setting. Enable this setting to view traffic analysis on the Mobility Master dashboard. You must enable this in the **/md** node hierarchy.

### In the WebUI

The following procedure enables firewall visibility on the managed devices using the WebUI:

1. In the **Managed Network** node hierarchy, navigate to **Configuration > Services > Firewall**.
2. Expand **Global Settings**.
3. In the **Enable firewall visibility** drop-down list, select **Enabled**.
4. Click **Submit**.
5. Click **Pending Changes**.
6. In the **Pending Changes** window, select the check box and click **Deploy changes**.

### In the CLI

The following command enables firewall visibility on the managed devices using the CLI:

```
(host) [md] (config) #firewall-visibility
(host) ^[md] (config) #write memory
```

## Multi-ALG Support

In ArubaOS 8.x, multiple applications running simultaneously on the same client device can be identified and prioritized. A maximum of 10 applications running simultaneously on client device is supported. The multi-ALG feature is enabled by default on Mobility Master.

## UCC ALG Configuration

The UCC ALGs must be configured from the **/mm** node hierarchy of Mobility Master. All the ALGs are enabled by default.



In master controller mode, UCC ALGs must be configured from the **/md** node hierarchy of the master controller. All the ALGs are enabled by default.



SpectraLink Voice Priority (SVP) ALG is enabled by default. ArubaOS does not have a separate configuration setting for this ALG.

## In the WebUI

The following procedure configures the ALGs using the WebUI:

1. In the **Mobility Master** node hierarchy, navigate to **Configuration > System > Profiles > All Profiles**.
2. Expand **UCC** to configure various ALGs as described in [Table 215](#).
3. Click **Save**.
4. Click **Pending Changes**.
5. In the **Pending Changes** window, select the check box and click **Deploy changes**.

**Table 215:** *ALG Configurations*

ALG	Description
FaceTime ALG Configuration	Configures the Apple FaceTime ALG. The ALG is enabled by default. The range is 0-63. The DSCP value for the video session is 34 by default.
H323 ALG Configuration	Configures the H.323 ALG. The ALG is enabled by default. The range is 0-63. The DSCP value for the voice session is 46 by default.
Intelligent Call Handling Configuration	Configures the Intelligent Call Handling. The setting is enabled by default. The range is 50-95. The Channel Utilization Threshold is 90 by default.
Jabber ALG Configuration	Configures the Cisco Jabber ALG. The ALG is enabled by default. Enter the Cisco Unified Communication Manager IM & Presence server IP. The range is 0-63. The DSCP values for the voice, video, and app-sharing sessions are 46, 34, and 34, respectively, by default.
NOE ALG Configuration	Configures the Alcatel-Lucent NOE ALG. The ALG is enabled by default. The range is 0-63. The DSCP value for the voice session is 46 by default.
Real-Time Analysis Configuration	Configures the real-time analysis of VoIP calls including upstream real-time analysis. The setting is enabled by default.



**Table 215: ALG Configurations**

ALG	Description
SCCP ALG Configuration	Configures the Cisco SCCP ALG. The ALG is enabled by default. The range is 0-63. The DSCP value for the voice session is 46 by default.
SIP ALG Configuration	Configures the SIP ALG. The ALG is enabled by default. You can enable the <b>SIP Midcall request timeout</b> and <b>RTCP inactivity</b> settings. The range is 0-63. The DSCP values for the voice and video sessions are 46 and 34, respectively, by default.
Skybe4B ALG Configuration	Configures the Microsoft® Lync/Skype for Business ALG. The ALG is enabled by default. You can set the Lync/Skype for Business SDN listen protocol over HTTP or HTTPS. The default Lync/Skype for Business SDN API listen port is 32000. Based on the SDN listen protocol configuration, Mobility Master accepts either HTTP or HTTPS messages from the Lync/Skype for Business SDN Manager. The DSCP values for the voice, video, and app-sharing sessions are 46, 34, and 34, respectively, by default. The range is 0-63.
UCC Session Idle Timeout Configuration	Configures the UCC session idle timeout. On configuring this parameter, if the voice session is idle for the configured period, UCM aborts the session on the managed device due to inactivity. The range is 35-250. The default value is 35.
Vocera ALG Configuration	Configure the Vocera ALG. The ALG is enabled by default. The range is 0-63. The DSCP value for the voice session is 46 by default.
Wi-Fi Calling Configuration	<p>Configures the Wi-Fi Calling. Wi-Fi Calling is enabled by default. The range is 0-62. The DSCP value for the voice session is 46 by default.</p> <p><b>dns-pattern</b>—Configure the DNS pattern for the carrier. A maximum of 10 DNS patterns can be configured.</p> <p>DNS patterns for known carriers are configured by default. Default built-in patterns are:</p> <ul style="list-style-type: none"> <li>• 3 HK - wlan.three.com.hk</li> <li>• ATT - epdg.epc.att.net</li> <li>• Rogers - epdg.epc.mnc720.mcc302.pub.3gppnetwork.org</li> <li>• SmarTone - epdg.epc.mnc006.mcc454.pub.3gppnetwork.org</li> <li>• Sprint - primgw.vowifi2.spcsdns.net</li> <li>• T-Mobile - ss.epdg.epc.mnc260.mcc310.pub.3gppnetwork.org</li> <li>• Verizon - wo.vzww.com</li> </ul> <p>If the ePDG FQDN of the carrier does not match with the default patterns, use this option to configure the DNS pattern for the carrier.</p> <p><b>NOTE:</b> The DNS IP address that Mobility Master learns for Wi-Fi Calling age out automatically, if there was no DNS query or response matching that IP for more than seven days.</p> <p><b>service-provider</b>—Add the service provider name for enhanced visibility.</p>

## In the CLI

The following command configures the ALGs using the CLI:

```
(host) [mm] (config) #ucc ?
facetime          Configure the FaceTime ALG Configuration
h323              Configure the H323 ALG Configuration
ich              Configure the Intelligent Call Handling Configuration
jabber           Configure the Jabber ALG Configuration
noe              Configure the NOE ALG Configuration
```

rtpa-config	Configure the Real-Time Analysis Configuration
sccp	Configure the SCCP ALG Configuration
session-idle-timeout	Configure the UCC Session Idle Timeout Configuration
sip	Configure the SIP ALG Configuration
skype4b	Configure the Skype4B ALG Configuration
vocera	Configure the Vocera ALG Configuration
wificalling	Configure the WiFiCalling Configuration

For more information, see the **ucc** command in the *ArubaOS Command-Line Interface Reference Guide*.

## View UCC Information




---

In master controller mode, you must login to the managed device to view the UCC configurations and statistics.

---

The following commands are available to view UCC client and call information using the CLI:

```
(host) [mm] #show ucc ?
call-info          Show ucc call detailed records (CDRs)
client-info        Show ucc client status and record
dns-ip-learning    DNS ip learning
facetime           Show the FaceTime ALG Configuration
h323               Show the H323 ALG Configuration
ich                Show the Intelligent Call Handling Configuration
internal-state     UCC internal-state information
jabber             Show the Jabber ALG Configuration
noe                Show the NOE ALG Configuration
rtpa-config        Show the Real-Time Analysis Configuration
rtpa-report        Show Real-Time Analysis report
sccp               Show the SCCP ALG Configuration
session-idle-timeout Show the UCC Session Idle Timeout Configuration
sip                Show the SIP ALG Configuration
skype4b            Show the Skype4B ALG Configuration
statistics         UCC statistics
trace-buffer       Show call trace buffer
vocera             Show the Vocera ALG Configuration
wificalling        Show the WiFiCalling Configuration
```

For more information, see the **show ucc** commands in the *ArubaOS Command-Line Interface Reference Guide*.

## Intelligent Call Handling

ArubaOS 8.x replaces Call Admission Control with Intelligent Call Handling (ICH). ICH monitors the channel utilization of all radios of the APs on the managed device. If the channel utilization exceeds beyond a configurable threshold on a radio, new UCC calls are not prioritized. This is to ensure that existing calls on the radio are not penalized due to a new call when channel utilization is very high. ICH is enabled by default and applies to all ALGs supported by UCM.




---

In master controller mode, ICH must be configured from the **/md** node hierarchy of the master controller.

---

### In the WebUI

The following procedure configures ICH using the WebUI:

1. In the **Mobility Master** node hierarchy, navigate to **Configuration > System > Profiles > All Profiles**.
2. Expand **UCC** and click **Intelligent Call Handling Configuration**.
3. In the **Intelligent Call Handling Configuration** section, configure the following settings:
  - a. Select the **Intelligent Call Handling** check box.

- b. In the **Channel Utilization Threshold** text-box, enter the channel utilization value.
4. Click **Save**.
5. Click **Pending Changes**.
6. In the **Pending Changes** window, select the check box and click **Deploy changes**.

### In the CLI

The following commands configure ICH using the CLI:

```
(host) [mm] (config) #ucc ich
(host) ^[mm] (Intelligent Call Handling Configuration) #enable
(host) ^[mm] (Intelligent Call Handling Configuration) #channel-utilization-threshold 90
```

## RTP Analysis

Mobility Master performs RTP analysis for most VoIP ALG calls in both downstream (at AP) and upstream direction (at managed device) and captures the quality metrics. The downstream UCC score measures call quality between the AP and the wireless client in the downstream direction. The upstream UCC score measures call quality over the wired network between the AP and the managed device in the upstream direction. The quality metrics captured is applicable for all the active sessions belonging to the same or different ALG running on that client.




---

In master controller mode, RTP analysis must be configured from the **/md** node hierarchy of the master controller.

---

### In the WebUI

The following procedure configures RTP analysis using the WebUI:

1. In the **Mobility Master** node hierarchy, navigate to **Configuration > System > Profiles > All Profiles**.
2. Expand **UCC** and click **Real-Time Analysis Configuration**.
3. In the **Real-Time Analysis Configuration** section, configure the settings described in [Table 216](#).
4. Click **Save**.
5. Click **Pending Changes**.
6. In the **Pending Changes** window, select the check box and click **Deploy changes**.

**Table 216:** *Real-Time Analysis Configuration Parameters*

Parameter	Description
Real-Time Analysis of VoIP calls	Enables real-time analysis of VoIP calls. This is the real-time analysis and UCC statistics calculated based on VoIP stream at the access point.
Upstream Real-Time Analysis of VoIP calls	Enables real-time analysis of upstream VoIP calls. This is the real-time analysis and UCC statistics calculated based on VoIP stream at the managed device.

### In the CLI

The following commands configure real-time analysis using the CLI:

```
(host) [mm] (config) #ucc rtpa-config
(host) ^[mm] (Real-Time Analysis Configuration) #enable
(host) ^[mm] (Real-Time Analysis Configuration) #upstream
(host) ^[mm] (Real-Time Analysis Configuration) #write memory
```



The upstream and downstream RTP analysis of VoIP calls are enabled by default.

The following command displays the real-time analysis configuration using the CLI:

```
(host) [mm] #show ucc rtpa-config
```

```
Real-Time Analysis Configuration
-----
Parameter                               Value      Set
-----
Real-Time Analysis of VoIP calls         Enabled
Upstream Real-Time Analysis of VoIP calls Enabled
```

The following command displays the real-time analysis report using the CLI:

```
(host) [mm] #show ucc rtpa-report
```

```
Help: [C] - Metric calculated at the Controller
      [A] - Metric calculated at the AP
      [E] - Metric calculated End-to-End
```

```
Real-Time Analysis Call Quality Report
-----
```

Client (IP) (usec) [C]	Client (MAC)	Client (Name)	ALG	Jitter (usec) [C]	Pkt-loss (%) [C]	Delay
192.168.201.240 101.800	f0:7b:cb:3b:65:5c	1002	SIP	23.700	0.000	
192.168.201.246 257.140	00:24:d7:40:a8:58	1003	SIP	30.912	0.000	

UCC Score [C]	Jitter (usec) [A]	Pkt-loss (%) [A]	Delay (usec) [A]	UCC Score [A]	Forward mode
68.366	0.000	0.499	316.400	84.119	decrypt-tunnel
82.551	0.000	0.000	327.478	85.999	decrypt-tunnel

```
Num Records:2
```

The following command displays real-time analysis for VoIP clients using the CLI. A session with the **Q** flag indicates downstream real-time analysis and that with the **u** flag indicates upstream real-time analysis:

```
(host) [mm] #show datapath session table 10.16.4.71 | include 10.16.4.80
```

```
Datapath Session Table Entries
-----
```

```
Flags: F - fast age, S - src NAT, N - dest NAT
D - deny, R - redirect, Y - no syn
H - high prio, P - set prio, T - set ToS
C - client, M - mirror, V - VOIP
Q - Real-Time Quality analysis
u - Upstream Real-Time Quality analysis
I - Deep inspect, U - Locally destined
E - Media Deep Inspect, G - media signal
r - Route Nexthop, h - High Value
B - Permanent, O - Openflow
L - Log
```

Source IP	Destination IP	Prot	SPort	DPort	Cntr	Prio	ToS	Age	Destination	TAge
10.16.4.80	10.16.4.71	17	20008	20038	0/0	6	46	0	local	24

Packets	Bytes	Flags
909	115732	HPTCIQuVBO

### RTP Analysis Limitations

- In case of split-tunnel forwarding mode, UCC score is not calculated if the calling and called party are behind the same remote AP.
- UCC score, jitter, delay, and packet loss is calculated for voice RTP streams only. These metrics are not available for video streams.
- Upstream UCC score is not supported for desktop sharing , file transfer, Apple Facetime, Spectralink SVP, Vocera, and Wi-Fi Calling ALGs.

### AppRF Integration with ALGs and User Role

The QOSMOS engine does not recognize many of the UCC applications. For the ones it recognizes, it does not maintain the state of the application. Due to this limitation, it cannot provide granular visibility into the UCC applications. To resolve this limitation, in ArubaOS 8.x, voice ALGs identify the application type for supported UCC applications, so that the administrator can now use AppRF rules to deny, permit, apply QoS, or rate limit UCC application traffic. The UCC application identifies all the supported applications listed below. The UCC application identifies the application type corresponding to a media session and programs the datapath with the application ID and the priority values. It is mandatory to add the ACLs to permit specific application traffics if an ACL rule is not present in the user-role to permit RTP/RTCP traffic. Following is a list of UCC applications that can be used to create application ACLs.

**Table 217:** UCC Application ACLs

UCC Application ACL
alg-facetime
alg-ftp
alg-h323
alg-jabber-audio
alg-jabber-desktop-sharing
alg-jabber-video
alg-noe
alg-rtsp
alg-sccp
alg-sip

**Table 217: UCC Application ACLs**

UCC Application ACL
alg-sip-audio
alg-sip-video
alg-skype4b-app-sharing
alg-skype4b-audio
alg-skype4b-desktop-sharing
alg-skype4b-file-transfer
alg-skype4b-secure
alg-skype4b-video
alg-svp
alg-vocera
alg-wifi-calling

The following pre-defined ACL are available by default. The administrator can either add the entire ACL to the appropriate user-role or selectively use the application IDs in another ACL and add that to the appropriate user-role.

```
ip access-list session voip-applications-acl
  any any app alg-skype4b-audio permit
  any any app alg-skype4b-video permit
  any any app alg-skype4b-desktop-sharing permit
  any any app alg-skype4b-app-sharing permit
  any any app alg-sip-audio permit
  any any app alg-sip-video permit
  any any app alg-sccp permit
  any any app alg-vocera permit
  any any app alg-noe permit
  any any app alg-h323 permit
  any any app alg-jabber-audio permit
  any any app alg-jabber-video permit
  any any app alg-facetime permit
  any any app alg-wifi-calling permit
  any any app alg-rtp permit
```

The ordering of the UCC application Access Control Entry (ACE) is not important except for the last ACE – **any any app alg-rtp permit**. The use of this ACE is to permit RTP traffic. This is important in a deployment having media application that is not identified by the UCC application. In such a case, the UCC application falls back to the **alg-rtp** ACE as the default application ID. If permitting random RTP traffic is a requirement, this ACE should be included in the ACL. In addition, this ACE should always be the last entry in the ACL.

An example of the ACE entries of **voip-applications-acl** follows:

```
(host) [mynode] #show ip access-list voip-applications-acl
```

```
ip access-list session voip-applications-acl
voip-applications-acl
```

```
-----
```

Priority	Source	Destination	Service	Application	Action	TimeRange
-----	-----	-----	-----	-----	-----	-----
1	any	any		app alg-skype4b-audio	permit	
2	any	any		app alg-skype4b-video	permit	
3	any	any		app alg-skype4b-desktop-sharing	permit	
4	any	any		app alg-skype4b-app-sharing	permit	
5	any	any		app alg-sip-audio	permit	
6	any	any		app alg-sip-video	permit	
7	any	any		app alg-sccp	permit	
8	any	any		app alg-vocera	permit	
9	any	any		app alg-noe	permit	
10	any	any		app alg-h323	permit	
11	any	any		app alg-jabber-audio	permit	
12	any	any		app alg-facetime	permit	
13	any	any		app alg-wifi-calling	permit	
	<b>14</b>	<b>any</b>	<b>any</b>	<b>app alg-rtp</b>		<b>permit</b>

```
-----
```

Log	Expired	Queue	TOS	8021P	Blacklist	Mirror	DisScan	IPv4/6	Contract
---	-----	-----	---	-----	-----	-----	-----	-----	-----
		Low						4	
		Low						4	
		Low						4	
		Low						4	
		Low						4	
		Low						4	
		Low						4	
		Low						4	
		Low						4	
		Low						4	
		Low						4	
		Low						4	
		Low						4	
		Low						4	
		Low						4	
		Low						4	

The following example adds an ACL to permit Lync/Skype for Business audio and video traffic and reference it to the user-role:

```
(host) [mynode] (config) #ip access-list session apprf-skype4b-sacl
(host) ^[mynode] (config-submode)#any any app alg-skype4b-audio permit
(host) ^[mynode] (config-submode)#any any app alg-skype4b-video permit
```

Other ACL rules like bandwidth contract, deny, 802.1p priority, and Type of Service (ToS) can be used along with the ACL application IDs.

## Microsoft® Lync/Skype for Business

ArubaOS provides a seamless user experience for Microsoft® Lync/Skype for Business users using voice or video calls, app-sharing, and file-transfer in a wireless environment. Microsoft® Lync/Skype for Business is an enterprise solution for UCC. It provides support for voice, video, app-sharing, and file-transfer. The Lync/Skype for Business SDN API provides an interface to Mobility Master to access Lync/Skype for Business network diagnostic information about voice, video, app-sharing, and file-transfer without having to see into the traffic.

### Lync/Skype for Business Media Classification Support in Mobility Master

By default, all the VoIP traffic undergo Media Classification on the managed device whenever RTP Traffic reaches the managed device. UCM in Mobility Master can identify and prioritize calls made using Lync/Skype

for Business ALG. UCM also provides visibility for all voice calls made using the Lync/Skype for Business ALG. UCM on Mobility Master dynamically opens firewall ports for voice and video traffic. The user does not have to explicitly define a firewall policy to permit such traffic.

### UCC Score for Lync/Skype for Business Media Classification

ArubaOS supports UCC score for Lync/Skype for Business calls prioritized using media classification. As part of this feature, UCM supports the following:

- Real-time quality analysis for Lync/Skype for Business voice and video calls (voice RTP streams only)
- Real-time computation of UCC score (delay, jitter, and packet loss) for Lync/Skype for Business VoIP calls prioritized using media classification. The UCC score is computed by the AP in the downstream direction and also at the managed device in the upstream direction.
- Call Quality vs. Client Health chart in the UCC dashboard of Mobility Master.



---

When VoIP calls are prioritized using media classification, end-to-end call quality metrics such as Mean Opinion Score (MOS), delay, jitter, and packet loss are not available.

---

UCC score computes the quality of voice calls. It takes delay, jitter, and packet loss of Real-time Transport Protocol (RTP) packets into account. UCC score is computed on a scale of 0 to 100. To compute the UCC score, you must enable RTP Analysis on Mobility Master. For more information, see [RTP Analysis on page 899](#).

### Available Call Quality Metrics

Following call quality metrics are available for Lync/Skype for Business calls prioritized by media classification:

Client IP, Client Mac, ALG, Duration(approximate), Orig time(approximate), Status, Reason, Call Type (voice/video), Client Health, UCC Score, UCC Band, Source port, Destination port, Originated and modified DSCP & WMM values, delay, jitter, and packet loss.

As the RTP packets are encrypted, following call quality metrics are not available for Lync/Skype for Business calls prioritized by media classification:

Client Name, Direction, Called to, MOS, MOS band, End-to-end Delay, jitter and packet loss.



---

File transfer and desktop sharing sessions are not prioritized by media classification. Upstream and downstream delay, jitter, and packet loss are not available for video sessions.

---

The **show ucc** commands displays statistics for media classification based Lync/Skype for Business ALG. For more information on the list of commands, see the *ArubaOS Command-Line Interface Reference Guide*. The UCC dashboard displays statistics for media classification based Lync/Skype for Business ALG. For more information on UCC dashboard, see [UCC Dashboard on page 923](#).

### Lync/Skype for Business Media Classification Limitations

- The media classification logic is applicable only for UDP-based RTP traffic, which applies to real-time voice and video calls.
- Lync/Skype for Business app-sharing and file-transfer sessions are not identified and prioritized by media classification.
- When using media classification, UCC score, jitter, delay, and packet loss is calculated only for voice RTP streams. These metrics are not available for video streams.
- Media classification does not work in split-tunnel forwarding mode.
- When VoIP calls are prioritized using media classification, end-to-end call quality metrics such as Mean Opinion Score (MOS), delay, jitter, and packet loss are not available.



- Media classification does not work when the managed device is performing a network address translation for media traffic. Media classification continues to work if the media traffic is subjected to Network Address Translation (NAT) beyond the managed device.

## Lync/Skype for Business SDN API Support in Mobility Master

To take advantage of UCC Lync/Skype for Business ALG, it is recommended to use the Lync/Skype for Business SDN API. ArubaOS 8.x supports Lync/Skype for Business SDN API 2.0, 2.1.1, 2.2, and 2.4.1. Lync/Skype for Business SDN API works with Microsoft Lync/Skype for Business server to export details about voice or video calls, app-sharing, and file-transfer to Mobility Master. The communication between the Lync/Skype for Business SDN API and Mobility Master occurs over HTTP or HTTPS.

In ArubaOS 6.x, Lync/Skype for Business SDN Manager sends the call information messages like start of call, interim update, and end of call to all the preconfigured local controllers though the clients are not present on the respective local controller. In ArubaOS 8.x, Lync/Skype for Business SDN Manager sends this information to Mobility Master only and not the managed devices. This reduces the network traffic originating from the Lync/Skype for Business SDN Manager and also relieves the managed devices of processing unwanted call information originating from the Lync/Skype for Business SDN Manager.

In master controller mode, Lync/Skype for Business SDN Manager sends the call information messages like start of call, interim update, and end of call to all the managed devices. The communication between the Lync/Skype for Business SDN API and managed devices occurs over HTTP or HTTPS.

## Lync/Skype for Business SDN API Configuration

The Lync/Skype for Business ALG should be configured from the **/mm** node hierarchy of Mobility Master. The ALG is enabled by default.



In master controller mode, Lync/Skype for Business ALG must be configured from the **/md** node hierarchy of the master controller. The ALG is enabled by default.

### In the WebUI

The following procedure configures the Lync/Skype for Business ALG using the WebUI:

1. In the **Mobility Master** node hierarchy, navigate to **Configuration > System > Profiles > All Profiles**.
2. Expand **UCC** and click **Skype4B ALG Configuration**.
3. In the **Skype4B ALG Configuration** section, configure the settings described in [Table 218](#).
4. Click **Save**.
5. Click **Pending Changes**.
6. In the **Pending Changes** window, select the check box and click **Deploy changes**.

**Table 218:** *Lync/Skype for Business ALG Configuration Parameters*

Parameter	Description
Skype4B ALG Support	Enables the Microsoft® Lync/Skype for Business ALG. The ALG is enabled by default.
Skype4B SDN Over http/https	You can set the Lync/Skype for Business SDN listen protocol over HTTP or HTTPS. On configuring this, the Lync diagnostic information will be received over HTTP or HTTPS. The default value is HTTP.
Voice Priority	Configures the DSCP value for the voice session. The default value is 46.

**Table 218:** Lync/Skype for Business ALG Configuration Parameters

Parameter	Description
Video Priority	Configures the DSCP value for the video session. The default value is 34.
App-sharing Priority	Configures the DSCP value for the app-sharing session. The default value is 34.

### In the CLI

The following commands configure the Lync/Skype for Business ALG using the CLI:

```
(host) [mm] (config) #ucc skype4b
(host) ^[mm] (Skype4B ALG Configuration) #enable
(host) ^[mm] (Skype4B ALG Configuration) #priority {app-sharing <app-sharing>| video
<video>|voice <voice>}
(host) ^[mm] (Skype4B ALG Configuration) #sdn {http|https}
(host) ^[mm] (Skype4B ALG Configuration) #write memory
```

The following commands display the Lync/Skype for Business ALG configuration using the CLI:

```
(host) [mynode] #show ucc skype4b
```

```
Sat Jun 25 03:25:43.429 2016
```

```
Skype4B ALG Configuration
-----
```

Parameter	Value	Set
-----	-----	---
Skype4B ALG Support	Enabled	
Skype4B SDN Over http/https	https	
voice priority	46	
video priority	34	
app-sharing priority	34	

### Lync/Skype for Business SDN Manager Configuration

Lync Dialog Listener must be installed and configured on the Lync front-end server. Lync/Skype for Business SDN Manager must be installed on a separate Windows 2008/2012 server (not on the Lync front-end server). If there are multiple front-end servers, Lync Dialog Listener should be installed on each server and configured to point at the Lync/Skype for Business SDN Manager. On Lync SDN Manager, the Mobility Master information needs to be configured.



In master controller mode, the managed device information needs to be configured on Lync/Skype for Business SDN Manager.

Depending on the transport mode configured in the Lync/Skype for Business SDN Manager, the same transport mode (HTTP or HTTPS) should be configured in the **Configuration > System > Profiles > All Profiles > UCC > Skype4B ALG Configuration** page of WebUI. The following configuration is a snippet of the Lync/Skype for Business SDN Manager configuration:



Lync/Skype for Business SDN Manager is a third-party product. The following configuration is an example and provided for illustration purposes only. If you plan to use this sample in your environment, ensure that the sample meets your IT guidelines. By running this sample configuration, you acknowledge that Aruba is in no way liable for any loss, damage, or problems arising from running this sample configuration.



Read and follow the installation instruction PDF that comes with the SDN API software to install Lync/Skype for Business Dialog Listener and Lync/Skype for Business SDN Manager.

```
<Configuration Version="2.0" culture="en-US" Kind="Subscriber" Identifier="Aruba"
LastModified="2015-10-27T13:06:59.7745572Z">
<parameter key="submituri">http://10.15.16.123:32000</parameter>
<parameter key="outputschema">D</parameter>
<parameter key="clientcertificateid"></parameter>
<parameter key="domainfilters"></parameter>
<parameter key="subnetfilters"></parameter>
```

As displayed in the above configuration, the Mobility Master IP address is added to the Lync/Skype for Business SDN Manager instead of the managed device IP address and the port number has to be 32000 which is a fixed port and not a configurable parameter on Mobility Master. The general format of the submit Uniform Resource Identifier (URI) is as follows:

```
http[s]://<Mobility Master-IP or fqdn>:32000
```




---

In master controller mode, the managed device's IP address is added to the Lync/Skype for Business SDN Manager.

---

## IP Session ACL and User Role Configuration

The following procedure configures a user-role for Lync/Skype for Business clients. In addition, the procedure provides steps to add an ACL to permit TCP traffic for app-sharing and file-transfer sessions.

### In the WebUI

The following procedure configures the IP session ACL to permit TCP traffic for app-sharing and file-transfer sessions using the WebUI:

1. In the **Managed Network** node hierarchy, navigate to **Configuration > Roles & Policies**.
2. In the **Roles** tab, select an existing role.
3. In the **Roles > <custom-role>** section, click **Show Advanced View**.
4. In the **Policies** tab, click the + icon. The **Add Policy** pop-up window opens.
5. In the **Add Policy** window, select the **Add existing session policy** option.
6. In the **Policy Name** drop-down list, select the **skype4b-acl** policy.
7. In the **Policy type** drop-down list, select **Session**.
8. Click **Submit**.
9. Repeat steps 4 and 5.
10. In the **Policy Name** drop-down list, select the **voip-application-acl** policy.
11. In the **Policy type** drop-down list, select **Session**.
12. Click **Submit**.
13. Click **Pending Changes**.
14. In the **Pending Changes** window, select the check box and click **Deploy changes**.

### In the CLI

The following commands configure the IP session ACL to permit TCP traffic for app-sharing and file-transfer sessions using the CLI:

```
(host) [md] (config) #user-role S4B-role
(host) ^[md] (config-submode) #session-acl skype4b-acl
(host) ^[md] (config-submode) #session-acl voip-applications-acl
(host) ^[md] (config-submode) #write memory
```

## Lync/Skype for Business Troubleshooting

The following section describes the step-by-step procedure to troubleshoot Lync/Skype for Business ALG:



---

In master controller mode, the **show** commands must be executed on the managed device.

---

1. Ensure that the global prerequisites to enable UCC in ArubaOS 8.x is configured. For more information, see [Prerequisites to Enable UCC on page 892](#).
2. Connect clients to the SSID; launch the Lync 2010/2013 or Skype for Business application; and make audio and video calls between them.
3. Make a few calls between clients. Execute the **show ucc client-info** and **show ucc call-info cdrs** commands and also access the UCC dashboard on the WebUI to view Lync/Skype for Business call statistics and prioritization.

```
(host) [mm] #show ucc client-info
```

```
Client Status:
```

```
-----
```

Client IP	Client MAC	Client Name	ALG	Server (IP)	Registration State
-----	-----	-----	---	-----	-----
10.16.4.76	00:24:d7:40:c0:a0	Derek	Skype4B		REGISTERED
10.16.4.71	00:21:6b:9d:f2:74	Allen	Skype4B		REGISTERED

Call Status	AP Name	Flags	Device Type	Home_Agent	Foreign_Agent
-----	-----	-----	-----	-----	-----
In-Call	2_205		Win 7	10.16.4.9	NA
In-Call	2_205		Win 7	10.16.4.9	NA

```
Total Client Entries:2
```

```
Flags: V - Visitor, A - Away, W - Wired, R - Remote, E - External
```

```
(host) [mm] #show ucc call-info cdrs
```

```
Help: [C] - Metric calculated at the Controller  
[A] - Metric calculated at the AP
```

```
CDR:
```

```
----
```

CDR ID	UCC Call ID	Client IP	Client MAC	Client Name	ALG
-----	-----	-----	-----	-----	---
4	2	10.16.4.71	00:21:6b:9d:f2:74	Derek	Skype4B
3	2	10.16.4.76	00:24:d7:40:c0:a0	Allen	Skype4B

Dir	Called to	Dur(sec)	Orig Time	Status	Reason	Call Type
---	-----	-----	-----	-----	-----	-----
OG	Scott	6	Nov 27 08:44:45	ACTIVE	NA	Voice
IC	Scott	6	Nov 27 08:44:45	ACTIVE	NA	Voice

Client Health	UCC Score[C]	UCC Score[A]	MOS
-----	-----	-----	---
80	70.80/Good	38.50/Fair	4.10/Good
85	77.88/Good	41.53/Fair	4.32/Good

```
Total Entries: 2
```

4. Execute the **show datapath session table** command on the managed device to verify if the calls are prioritized. A client with the **Q** flag indicates real-time analysis and a client with **u** flag indicates RTP analysis of upstream VoIP calls.

```
(host-mn) #show datapath session table 10.16.4.67
```

Datapath Session Table Entries

```

-----
Flags: F - fast age, S - src NAT, N - dest NAT
D - deny, R - redirect, Y - no syn
H - high prio, P - set prio, T - set ToS
C - client, M - mirror, V - VOIP
Q - Real-Time Quality analysis
u - Upstream Real-Time Quality analysis
I - Deep inspect, U - Locally destined
E - Media Deep Inspect, G - media signal
r - Route Nexthop, h - High Value
B - Permanent, O - Openflow
L - Log
  
```

Source IP	Destination IP	Prot	SPort	DPort	Cntr	Prio	ToS	Age
10.16.4.72	10.16.4.67	17	20002	20008	0/0	5	40	0
10.16.4.72	10.16.4.67	17	20003	20008	0/0	0	0	1
10.16.4.67	10.16.4.72	17	20012	20039	0/0	6	46	0

Destination	TAge	Packets	Bytes	Flags
tunnel 22	24	398	151870	FHPTV <b>QuI</b>
tunnel 10	23	2	252	FCIE
local	f2	0	0	FYHPTMCVBO

- Execute the **show ucc client-info** command to verify if the Lync/Skype for Business clients are in **In-Call** state.

```
(host) [mm] #show ucc client-info
```

Client Status:

```

-----
Client IP      Client MAC      Client Name    ALG      Server (IP)    Registration State
-----
10.16.4.76    00:24:d7:40:c0:a0  Derek         Skype4B          10.16.4.9      REGISTERED
10.16.4.71    00:21:6b:9d:f2:74  Allen         Skype4B          10.16.4.9      REGISTERED
  
```

```

Call Status  AP Name  Flags  Device Type  Home_Agent  Foreign_Agent
-----
In-Call     2_205   Win 7   Win 7        10.16.4.9   NA
In-Call     2_205   Win 7   Win 7        10.16.4.9   NA
  
```

Total Client Entries:2

Flags: V - Visitor, A - Away, W - Wired, R - Remote, E - External

- If Mobility Master uses Lync/Skype for Business SDN API, you can view the client name, called party, and end to end call quality for every Lync/Skype for Business calls on Mobility Master.
- Execute the **show ucc trace-buffer skype4b** command to verify if Mobility Master is receiving and processing call information from the Lync/Skype for Business SDN manager.

```
(host) [mm] #show ucc trace-buffer skype4b
```

Skype4b Voice Client(s) Message Trace

```

-----
Client IP      Client MAC      Client Name    Direction  Event Time      BSSID
-----
192.0.2.22    00:23:33:41:c8:b8  Alex          OG         Jan  3 11:24:34  9c:1c:12:8a:b5:50
192.0.2.26    24:77:03:9a:6c:dc  John          OG         Jan  3 11:24:34  9c:1c:12:8a:b5:50
192.0.2.29    00:22:90:ea:9e:f1  Steve         OG         Jan  3 11:24:08  9c:1c:12:8a:b5:50
  
```

Called To	Media Type	AP Name	Src Port	Dest Port	Call Status
-----	-----	-----	-----	-----	-----

```

Joe      Voice/Video AP-225  50030/58008  50032/58006  Start of call
Mike     Voice/Video AP-225  50032/58006  50030/58008  InCallQuality Update
Ken      Voice       AP-225  50026        50038        Call Quality Update

```

Num of Rows:3

- Execute the **show datapath session table** command on the managed device and look for the **O** flag indicating if the RTP/RTCP-related flows is installed on the managed device using OpenFlow protocol.

```
(host-mn) #show datapath session table 10.16.4.67
```

Datapath Session Table Entries

```

-----
Flags: F - fast age, S - src NAT, N - dest NAT
D - deny, R - redirect, Y - no syn
H - high prio, P - set prio, T - set ToS
C - client, M - mirror, V - VOIP
Q - Real-Time Quality analysis
u - Upstream Real-Time Quality analysis
I - Deep inspect, U - Locally destined
E - Media Deep Inspect, G - media signal
r - Route Nexthop, h - High Value
B - Permanent, O - Openflow
L - Log

```

Source IP	Destination IP	Prot	SPort	DPort	Cntr	Prio	ToS	Age
10.15.17.207	10.15.17.202	17	20004	20005	0/0	6	46	0
10.15.17.202	10.15.17.207	17	20005	20004	0/0	6	46	0

Destination	TAge	Packets	Bytes	Flags
local	1b	325	46131	FHPTCIVBO
local	3	347	41474	FHPTCIVBO

- Execute the **show ucc call-info cdrs** to display the Call Detail Record (CDR) information or access the **Dashboard > UCC** page on the WebUI to verify if the calls are identified and prioritized.

```
(host) [mm] #show ucc call-info cdrs
```

```

Help:  [C] - Metric calculated at the Controller
       [A] - Metric calculated at the AP

```

CDR:

CDR ID	UCC Call ID	Client IP	Client MAC	Client Name	ALG
4	2	10.16.4.71	00:21:6b:9d:f2:74	Derek	Skype4B
3	2	10.16.4.76	00:24:d7:40:c0:a0	Allen	Skype4B

Dir	Called to	Dur(sec)	Orig Time	Status	Reason	Call Type
OG	Ian	6	Nov 27 08:44:45	ACTIVE	NA	Voice
IC	Ian	6	Nov 27 08:44:45	ACTIVE	NA	Voice

Client Health	UCC Score[C]	UCC Score[A]	MOS
NA	NA	NA	NA
NA	NA		

Total Entries: 2

- Execute the **show ucc statistics counter call client** and **show ucc statistics counter call global** commands to view the different call metrics.

```
(host) [mm] #show ucc statistics counter call client
```

Per Client Call Counters:

```
-----  
Client IP      Client MAC      Call Originated  Call Terminated  Active  Success  
-----  
10.16.4.76    00:24:d7:40:c0:a0  0                1                  1       0  
10.16.4.71    00:21:6b:9d:f2:74  0                1                  1       0  
10.16.4.79    00:24:d7:40:ff:a0  0                0                  0       0
```

```
Failed  Blocked  Aborted  Forwarded  WMM AC-VI  WMM AC-VO  WMM-BK  WMM-BE  
-----  
0       0       0       0         0         0         0       1  
0       0       0       0         0         0         0       1  
0       0       0       0         0         0         0       0
```

WMM (VI, VO, BK, BE):total calls with received priority

(host) [mynode] #show ucc statistics counter call global

System-wide Call Counters:

```
-----  
Call Originated  Call Terminated  Active  Success  Failed  Blocked  Aborted  
-----  
0                2                2       0        0       0       0  
  
Forwarded  WMM AC-VI  WMM AC-VO  WMM-BK  WMM-BE  
-----  
0         0         0         0       2
```

Device Type Allocations:

```
-----  
Device Type  WMM AC-VI  WMM AC-VO  WMM-BK  WMM-BE  
-----  
Win 7        0          0          0       2
```

WMM (VI, VO, BK, BE):total calls with received priority)

11. If the clients are not seen after executing the **show ucc client-info** command, verify the output by executing the **show gsm debug channel ucc\_client**, **show gsm debug channel ucc\_session**, and **show gsm debug channel ip\_user**.

(host) [mm] #show gsm debug channel ucc\_client

ucc\_client Channel Table

```
-----  
state  uc_client_mac      uc_client_ip  uc_contact_name  uc_server_name  uc_client_flags  
-----  
ACTV   80:86:f2:40:b3:d4  10.15.88.247  1008             10.15.16.30     1  
ACTV   80:86:f2:40:14:9c  10.15.88.245  1007             10.15.16.30     1
```

```
uc_reg_state  uc_alg  uc_entry_type  uc_role  uc_active_call  uc_replicatorip  
-----  
4             14     1              0        0                10.15.88.100  
4             14     1              0        0                10.15.88.100
```

Total Num of Objects :2  
Total Num of Active Objects :2  
Total Num of Replicated Objects :0

(host) [mm] #show gsm debug channel ucc\_session

ucc\_session Channel Table

```

state uc_client_mac      uc_client_ip  uc_active_call
-----
ACTV  80:86:f2:40:b3:d4  10.15.88.247  0
ACTV  80:86:f2:40:14:9c  10.15.88.245  0

```

```

Total Num of Objects      :2
Total Num of Active Objects :2
Total Num of Replicated Objects :0

```

```
(host) [mm] #show gsm debug channel ip_user
```

```
ip_user Channel Table
```

```

-----
state v_repkey  user_ip_address  user_uuid          ip_user_flags  ip_user_
timestamp
-----
-
REPL  3          10.15.88.245    001a1e01b2280000002f0064  0              181193397240
REPL  3          10.15.88.247    001a1e01b2280000002f0065  0              181193397370

```

```

Total Num of Objects      :2
Total Num of Active Objects :0
Total Num of Replicated Objects :2

```

```
Total number of hosts: 3
```

## 12. Execute the **show ucc rtpa-report** command to view the Real-Time analysis report.

```
(host) [mm] #show ucc rtpa-report
```

```

Help:  [C] - Metric calculated at the Controller
       [A] - Metric calculated at the AP
       [E] - Metric calculated End-to-End

```

```
Real-Time Analysis Call Quality Report
```

```

-----
Client (IP)  Client (MAC)      Client (Name)  ALG      Jitter (usec) [C]
-----
10.16.4.76  00:24:d7:40:c0:a0  Derek         Skype4B  308.200
10.16.4.71  00:21:6b:9d:f2:74  Allen         Skype4B  1119.080

Pkt-loss (%) [C]  Delay (usec) [C]  UCC Score [C]  Jitter (usec) [A]  Pkt-loss (%) [A]
-----
0.000            118.000          92.346         36.840              0.000
0.000            35.400           76.210         101.679             0.000

Delay (usec) [A]  UCC Score [A]  Forward mode
-----
344.610          40.116         tunnel
581.034          48.956         tunnel

```

```
Num Records:2
```

## 13. Execute the **show openflow-controller hosts** command to verify if the users are learned as OpenFlow hosts. If a host entry is not present for a user then flow will not be installed and the call will not be prioritized.




---

This command is not supported in master controller mode.

---

```
(host) [mm] #show openflow-controller hosts
```

```
Hosts
```



```

-----
IP                MAC                Wireless  Dpid
---                ---                -
10.15.88.245      80:86:f2:40:14:9c  True      00:00:00:1a:1e:01:b2:28
10.15.88.235      ac:bc:32:78:33:a1  True      00:00:00:1a:1e:01:b2:28
10.15.19.39       00:0c:29:e4:88:93  false     00:00:00:0c:29:e8:b8:b9

```

```

Port No  Port MAC
-----  -
21       ac:a3:1e:ca:7d:c0
19       d8:c7:c8:c9:23:8b
1        00:0c:29:e8:b8:ba

```

Total number of hosts: 3

- Execute the **show openflow-controller flow-table** command on Mobility Master to verify if the flows are installed accurately.




---

This command is not supported in master controller mode.

---

```
(host) [mm] #show openflow-controller flow-table
```

```
Flow-table
-----
```

Dpid	In Port	Src Mac	Dst Mac	Ether	Src IP
00:00:00:0c:29:a1:de:01	*	*	*	0x800	222.173.190.239
00:00:00:0b:86:9a:16:77	*	*	*	0x800	222.173.190.239

Dst IP	Proto	Src Port	Dst Port	App Name	Actions
186.173.202.254	17	60000	60000	ucm	output=controller
186.173.202.254	17	60000	60000	ucm	output=controller

Total number of flows: 2

- Execute the **show openflow flow-table** command on the managed device to check if the OpenFlows are getting programmed in the managed device.




---

This command is not supported in master controller mode.

---

```
(host-mn) #show openflow flow-table
```

```
Openflow Flow Table
-----
```

In Port	Src Mac	Dst Mac	Ether	Src IP	Dst IP	Proto
*	*	*	0x800	1.1.1.1	2.2.2.2	97
*	*	*	0x800	192.168.201.251	192.168.201.250	6
*	*	*	0x800	222.173.190.239	186.173.202.254	17
*	*	*	0x800	192.168.201.250	192.168.201.251	6

Src Port	Dst Port	Packets	Bytes	Actions
*	*	0	0	(Output:controller)
42017	42008	0	0	, (Set IP ToS:34), (Set Vlan pcp:5), (Set AppID:2565) (Output:normal), (Write Flag:VH)
60000	60000	0	0	(Output:controller)

```
42008      42017      0      0      , (Set IP ToS:34), (Set Vlan pcp:5), (Set AppID:2565)
(Output:normal), (Write Flag:VH)
```

Total number of flows: 4

## Cisco Jabber

Cisco Jabber is an enterprise collaboration application that supports the following protocols:

- Voice call based on SIP signaling and media on RTP protocol
- Video call based on SIP signaling and media on RTP protocol
- Desktop-sharing based on SIP signaling and Binary Floor Control Protocol (BFCP) and media on RTP protocol
- File-transfer based on TCP protocol

Cisco Jabber is an all-in-one application and significant number of customers deploy this application in open SIP mode without encryption. As Cisco Jabber deployment continues to gain a larger foothold in the collaboration space, it is important to ensure QoS for its delay-sensitive applications such that there is no perceptible difference in the user experience between wireless and wired networks.

### Cisco Jabber Support in ArubaOS 8.x

ArubaOS 8.x provides QoS and visibility for voice, video calls, and desktop-sharing sessions made using an unencrypted version of the Cisco Jabber client. UCM can uniquely identify and prioritize Cisco jabber voice, video calls, and desktop-sharing sessions.

### Open SIP ALG Enhancements

Cisco Jabber is an all-in-one application, enabling a user to perform functions in addition to audio and video calls. The existing SIP ALG is enhanced to support Cisco Jabber.

#### Parser Logic Enhancement

The current SIP ALG parser is capable of handling audio calls. The same is extended to handle video calls, app-sharing, hold/resume calls, conference calls, and call transfer.

Two additional ports, namely TCP 5222 and TCP 8443 are added to the default **jabber-acl** IP access list. These ports are required for the clients to register to the server.

```
(host) [md] (config) #ip access-list session jabber-acl
(host) [md] (config-submode) #any any tcp 5222 permit
(host) [md] (config-submode) #any any tcp 8443 permit
```

The **jabber-acl** IP access list is included in the voice user-role by default. If the administrator chooses to use any other custom user-role, the ACL should be added manually to the custom user-role.

#### Identification of Cisco Jabber Clients

A new configuration setting **Jabber Server IP** is introduced where an administrator can configure the Cisco Jabber server (Cisco Unified Communication Manager and Cisco Unified Presence Manager) IP address for client identification. You can configure up to 16 such IP addresses.

### Cisco Jabber Configuration

You should enable DPI on the managed device for Cisco Jabber to work. For more information on enabling DPI, see [Deep Packet Inspection Configuration on page 895](#).

The Cisco Jabber ALG should be configured from the **/mm** node hierarchy of Mobility Master. The ALG is enabled by default.



In master controller mode, Cisco Jabber ALG must be configured from the **/md** node hierarchy of the master controller. The ALG is enabled by default.

### In the WebUI

The following procedure configures the Cisco Jabber ALG using the WebUI:

1. In the **Mobility Master** node hierarchy, navigate to **Configuration > System > Profiles > All Profiles**.
2. Expand **UCC** and click **Jabber ALG Configuration**.
3. In the **Jabber ALG Configuration** section, configure the settings described in [Table 219](#).
4. Click **Save**.
5. Click **Pending Changes**.
6. In the **Pending Changes** window, select the check box and click **Deploy changes**.

**Table 219:** Cisco Jabber ALG Configuration Parameters

Parameter	Description
Jabber ALG Support	Enables the Cisco Jabber ALG. The ALG is enabled by default.
Jabber Server IP	Configures the Cisco Jabber server (Cisco Unified Communication Manager and Cisco Unified Presence Server) IP address to uniquely identify Cisco Jabber clients. <b>NOTE:</b> This is a mandatory configuration setting.
Voice Priority	Configures the DSCP value for the voice session. The default value is 46.
Video Priority	Configures the DSCP value for the video session. The default value is 34.
App-sharing Priority	Configures the DSCP value for the app-sharing session. The default value is 34.

### In the CLI

The following commands configure the Cisco Jabber ALG using the CLI:

```
(host) [mm] (config) #ucc jabber
(host) ^[mm] (Jabber ALG Configuration) #enable
(host) ^[mm] (Jabber ALG Configuration) #priority {app-sharing <app-sharing>| video
<video>|voice <voice>}
(host) ^[mm] (Jabber ALG Configuration) #server-ip <server-ip>
(host) ^[mm] (Jabber ALG Configuration) #write memory
```

The following commands display the Cisco Jabber ALG configuration using the CLI:

```
(host) [mynode] #show ucc jabber

Jabber ALG Configuration
-----
Parameter          Value          Set
-----          -
Jabber ALG Support  Enabled
Jabber server ip    10.15.16.30
Jabber server ip    10.15.16.31
voice priority      46
video priority      34
```

## Cisco Jabber Troubleshooting

The following section describes the step-by-step procedure to troubleshoot Cisco Jabber ALG:



In master controller mode, the **show** commands must be executed on the managed device.

1. Ensure that the global prerequisites to enable UCC in ArubaOS 8.x is configured. For more information, see [Prerequisites to Enable UCC on page 892](#).
2. Ensure that the Cisco Jabber server (Cisco Unified Communication Manager and Cisco Unified Presence Manager) IP addresses are configured under the Cisco Jabber ALG configuration.
3. Connect clients to the SSID.
4. Launch the Cisco Jabber application in the client and log in with the credentials to register with the Cisco Unified Communication Manager and Cisco Unified Presence Manager servers.
5. Execute the **show ucc client-info** command to verify if the ALG type is **Jabber** and the registration status is **REGISTERED**.

```
(host) [mm] #show ucc client-info
```

```
Thu Dec 03 08:48:09.077 2015
```

```
Client Status:
```

```
-----
```

Client IP	Client MAC	Client Name	ALG	Server (IP)	Registration State
10.15.88.235	ac:bc:32:78:33:a1	1019	Jabber	10.15.16.30	REGISTERED
10.15.88.247	80:86:f2:40:b3:d4	1008	Jabber	10.15.16.30	REGISTERED

Call Status	AP Name	Flags	Device Type	Home_Agent	Foreign_Agent
Idle	AP-105		OS X	10.15.88.100	NA
In-Call	AP-115		Win 7	10.15.88.100	NA

```
Total Client Entries:2
```

```
Flags: V - Visitor, A - Away, W - Wired, R - Remote, E - External
```

6. Start audio, video calls, and app-sharing sessions between Cisco Jabber clients.
7. Execute the **show ucc client-info** and **show ucc call-info cdrs** commands or access the **Dashboard > UCC** page on the WebUI to view Cisco Jabber call statistics and prioritization.

```
(host) [mm] #show ucc client-info
```

```
Thu Dec 03 08:48:09.077 2015
```

```
Client Status:
```

```
-----
```

Client IP	Client MAC	Client Name	ALG	Server (IP)	Registration State
10.15.88.235	ac:bc:32:78:33:a1	1019	Jabber	10.15.16.30	REGISTERED
10.15.88.247	80:86:f2:40:b3:d4	1008	Jabber	10.15.16.30	REGISTERED

Call Status	AP Name	Flags	Device Type	Home_Agent	Foreign_Agent
Idle	AP-105		OS X	10.15.88.100	NA
In-Call	AP-115		Win 7	10.15.88.100	NA

```
Total Client Entries:2
```

```
Flags: V - Visitor, A - Away, W - Wired, R - Remote, E - External
```

```
(host) [mm] #show ucc call-info cdrs
```

```
Thu Dec 03 08:48:23.827 2015
```

```
Help: [C] - Metric calculated at the Controller  
      [A] - Metric calculated at the AP
```

```
CDR:
```

```
----
```

CDR ID	UCC Call ID	Client IP	Client MAC	Client Name	ALG	Dir	Called to
140	53	10.15.88.247	80:86:f2:40:b3:d4	1008	Jabber	OG	1019
138	53	10.15.88.247	80:86:f2:40:b3:d4	1008	Jabber	OG	1019

Dur(sec)	Orig Time	Status	Reason	Call Type	Client Health
21164	Dec 3 02:55:39	ACTIVE	NA	Voice	0
21164	Dec 3 02:55:39	ACTIVE	NA	Voice	0

UCC Score[C]	UCC Score[A]	MOS
70.80/Good	38.50/Fair	4.10/Good
77.88/Good	41.53/Fair	4.32/Good

```
Total Entries:2
```

- Execute the **show ucc client-info** command. If the **ALG** column displays **SIP** instead of **Jabber**, ensure that the Cisco Unified Communication Manager and Cisco Unified Presence Server IP addresses are added as part of the Cisco Jabber configuration in Mobility Master. In addition, verify if DPI is enabled on Mobility Master.
- Execute the **show ucc trace-buffer jabber** command to verify if call signaling events such as establishing voice, video, desktop sharing, and file transfer are recorded.

```
(host) [mm] #show ucc trace-buffer jabber
```

```
Jabber Voice Client(s) Message Trace
```

```
-----
```

Client IP	Client MAC	Client Name	Direction	Event Time	BSSID
10.15.88.234	68:17:29:9f:b6:77	3002	Server-To-Client	Jul 4 22:48:28	
ac:a3:1e:27:dc:00	200_OK				
10.15.88.234	68:17:29:9f:b6:77	3002	Server-To-Client	Jul 4 22:48:27	
ac:a3:1e:27:dc:00	100_TRYING				
10.15.88.234	68:17:29:9f:b6:77	3002	Client-To-Server	Jul 4 22:48:27	
ac:a3:1e:27:dc:00	REGISTER				
10.15.88.234	68:17:29:9f:b6:77	3002	Server-To-Client	Jul 4 22:46:32	
ac:a3:1e:27:dc:00	200_OK				

- If the clients are not seen after executing the **show ucc client-info** command, verify the output by executing the **show gsm debug channel ucc\_client**, **show gsm debug channel ucc\_session**, **show gsm debug channel ip\_user**, and **show openflow-controller hosts**.

```
(host) [mm] #show gsm debug channel ucc_client
```

```
ucc_client Channel Table
```

```
-----
```

state	uc_client_mac	uc_client_ip	uc_contact_name	uc_server_name	uc_client_flags
ACTV	80:86:f2:40:b3:d4	10.15.88.247	1008	10.15.16.30	1
ACTV	80:86:f2:40:14:9c	10.15.88.245	1007	10.15.16.30	1

```
uc_reg_state uc_alg uc_entry_type uc_role uc_active_call uc_replicatorip
```

```

-----
4          14      1          0          0          10.15.88.100
4          14      1          0          0          10.15.88.100

```

```

Total Num of Objects      :2
Total Num of Active Objects :2
Total Num of Replicated Objects :0

```

(host) [mm] #show gsm debug channel ucc\_session

ucc\_session Channel Table

```

-----
state  uc_client_mac      uc_client_ip  uc_active_call
-----
ACTV   80:86:f2:40:b3:d4    10.15.88.247  0
ACTV   80:86:f2:40:14:9c    10.15.88.245  0

```

```

Total Num of Objects      :2
Total Num of Active Objects :2
Total Num of Replicated Objects :0

```

(host) [mm] #show gsm debug channel ip\_user

ip\_user Channel Table

```

-----
state  v_repkey  user_ip_address  user_uuid          ip_user_flags  ip_user_
timestamp
-----
-
REPL   3         10.15.88.245    001a1e01b228000002f0064  0              181193397240
REPL   3         10.15.88.247    001a1e01b228000002f0065  0              181193397370

```

```

Total Num of Objects      :2
Total Num of Active Objects :0
Total Num of Replicated Objects :2

```

(host) [mm] #show openflow-controller hosts

Hosts

```

-----
IP          MAC          Wireless
--          ---          -
10.15.88.245  80:86:f2:40:14:9c  True
10.15.88.235  ac:bc:32:78:33:a1  True
10.15.19.39   00:0c:29:e4:88:93  false

```

```

Dpid          Port No  Port MAC
-----
00:00:00:1a:1e:01:b2:28  21      ac:a3:1e:ca:7d:c0
00:00:00:1a:1e:01:b2:28  19      d8:c7:c8:c9:23:8b
00:00:00:0c:29:e8:b8:b9  1       00:0c:29:e8:b8:ba

```

Total number of hosts: 3

- Execute the **show datapath session table** command on the managed device to verify if the calls are prioritized. The ToS values should be set for this session, along with other flags like **V, H, P, T, O**.

(host-mn) #show datapath session dpi table | include V, Age

C - client, M - mirror, V - VOIP  
r - Route Nexthop, h - High Value

Source IP Packets	Destination IP	Prot	SPort	DPort	Cntr	Prio	ToS	Age	Destination	TAge
10.15.89.250	10.15.89.231	17	26344	26112	0/0	5	34	0	local	31 173
10.15.89.250	10.15.89.231	17	26345	26113	0/0	5	34	0	local	31 76
10.15.89.250	10.15.89.231	17	23843	16767	0/0	6	46	0	local	31 2
10.15.89.231	10.15.89.250	17	16767	23843	0/0	6	46	0	local	31 5

Bytes	SIDX	AclVer	Int-Flag	PktsDpi	UplnkVlan	AppID
185458	39b56	1632	2101	0	none	alg-jabber-video (2570)
4420	4b952	1632	2101	0	none	alg-jabber-video (2570)
220	87e7f	1632	2101	0	none	alg-jabber-audio (2569)
624	a5a70	1632	2125	0	none	alg-jabber-audio (2569)

AceIdx	Flags	User-MAC	DpiTIdx
0/561	FHPTCVBO	00:00:00:00:00:00	5e
0/561	FHPTMCVBO	00:00:00:00:00:00	84
0/560	FHPTMCVBO	00:00:00:00:00:00	8d
0/560	FHPTMCVBO	00:00:00:00:00:00	c5

## Cisco Jabber Limitations

The following are the list of limitations in Cisco Jabber:

- Visibility is not available for file transfer and a pure desktop-sharing sessions. In a pure desktop-sharing session, there is no simultaneous voice/video session going on.
- In a stand-alone or master controller deployment, visibility is not available for desktop -sharing with or without simultaneous voice/video session.
- If eXtensible Messaging and Presence Protocol (XMPP) signaling is not received for any reason before the SIP signaling from the Jabber client, the client will be identified as SIP and not Jabber.

## Wi-Fi Calling

Wi-Fi calling service allows cellular users to make or receive calls using a Wi-Fi network instead of using the carrier's cellular network. Wi-Fi calling allows users to place, receive calls, and text messages even when they are beyond a cellular coverage but having a Wi-Fi network coverage. Major carriers around the world support Wi-Fi calling service.

### Wi-Fi Calling Support in ArubaOS 8.x

ArubaOS 8.x provides QoS for voice calls made using Wi-Fi calling. UCM can identify and prioritize calls made using Wi-Fi calling. UCM also provides visibility for all voice calls made using Wi-Fi calling.

### Wi-Fi Calling Operation

At a high level, this is how Wi-Fi calling operates:

1. Wi-Fi Calling-capable handset initiates a DNS query to locate the carrier's evolved Packet Data Gateway (ePDG).
2. The handset establishes a persistent IPsec tunnel with ePDG.
3. Calls, text, and traffic for other services offered by the carrier are then carried over in this IPsec tunnel.

Some carriers use a standard FQDN format for ePDG that includes their Mobile Network Code (MNC) and Mobile Country Code (MCC). For example, T-Mobile uses `ss.epdg.epc.mnc260.mcc310.pub.3gppnetwork.org`. Others follow a different standard format. For example, AT&T uses `epdg.epc.att.net`. For a list of well known carrier DNS patterns, see [Table 220](#).

## Wi-Fi Calling Configuration

The Wi-Fi Calling ALG should be configured from the **/mm** node hierarchy of Mobility Master. This ALG is enabled by default.



In master controller mode, Wi-Fi Calling ALG must be configured from the **/md** node hierarchy of the master controller. The ALG is enabled by default.

### In the WebUI

The following procedure configures the Wi-Fi Calling ALG using the WebUI:

1. In the **Mobility Master** node hierarchy, navigate to **Configuration > System > Profiles > All Profiles**.
2. Expand **UCC** and click **Wi-Fi Calling ALG Configuration**.
3. In the **Wi-Fi Calling ALG Configuration** section, configure the settings described in [Table 220](#).
4. Click **Save**.
5. Click **Pending Changes**.
6. In the **Pending Changes** window, select the check box and click **Deploy changes**.

**Table 220:** *Wi-Fi Calling ALG Configuration Parameters*

Parameter	Description
Wi-Fi Calling Support	Enables the Wi-Fi Calling ALG. The ALG is enabled by default.
Voice Priority	Configures the DSCP value for the voice session. The default value is 46.
DNS Pattern	<p><b>dns-pattern</b>—Configure the DNS pattern for the carrier. A maximum of 10 DNS patterns can be configured.</p> <p>DNS patterns for known carriers are configured by default. Default built-in patterns are:</p> <ul style="list-style-type: none"> <li>• 3 HK - wlan.three.com.hk</li> <li>• ATT - epdg.epc.att.net</li> <li>• Rogers - epdg.epc.mnc720.mcc302.pub.3gppnetwork.org</li> <li>• SmarTone - epdg.epc.mnc006.mcc454.pub.3gppnetwork.org</li> <li>• Sprint - primgw.vowifi2.spcsdns.net</li> <li>• T-Mobile - ss.epdg.epc.mnc260.mcc310.pub.3gppnetwork.org</li> <li>• Verizon - wo.vzwwo.com</li> </ul> <p>If the ePDG FQDN of the carrier does not match with the default patterns, use this option to configure the DNS pattern for the carrier.</p> <p><b>NOTE:</b> The DNS IP address that Mobility Master learns for Wi-Fi Calling age out automatically, if there was no DNS query or response matching that IP for more than seven days.</p> <p><b>service-provider</b>—Add the service provider name for enhanced visibility.</p>



## In the CLI

The following commands configure the Wi-Fi Calling ALG using the CLI:

```
(host) [mm] (config) #ucc wificalling
(host) ^[mm] (WiFiCalling Configuration) #enable
(host) ^[mm] (WiFiCalling Configuration) #priority voice <voice>
(host) ^[mm] (WiFiCalling Configuration) #dns-pattern <dns-pattern> service-provider <service-provider>
(host) ^[mm] (WiFiCalling Configuration) #write memory
```

The following command displays the Wi-Fi Calling ALG configuration using the CLI:

```
(host) [mm] #show ucc wificalling
```

```
WiFiCalling Configuration
-----
Parameter          Value      Set
-----
WiFiCalling Support Enabled
voice priority      46
dns pattern         att.net   ATT
```

## Wi-Fi Calling Troubleshooting

The following section describes the step-by-step procedure to troubleshoot Wi-Fi Calling ALG:



---

In master controller mode, the **show** commands must be executed on the managed device.

---

1. Ensure that the global prerequisites to enable UCC in ArubaOS 8.x is configured. For more information, see [Prerequisites to Enable UCC on page 892](#).
2. Connect the 'Wi-Fi Calling'-capable handset to the SSID.
3. Add the default **wificalling-acl** and **voip-applications-acl** ACLs to the user-role. By default, these ACLs are included in the voice user-role.
4. When the handset establishes a persistent IPsec tunnel with ePDG, it displays the Wi-Fi Calling icon.
5. Execute the **show ucc dns-ip-learning** command to verify if the ePDG IP address is learned.

```
(host) [mynode] #show ucc dns-ip-learning
```

```
DNS IP Learning:
-----
IP Address      Service Provider
-----
208.54.85.108   T-Mobile
208.54.73.77    T-Mobile
208.54.70.110   T-Mobile
208.54.77.253   T-Mobile
208.54.75.2     T-Mobile
208.54.85.64    T-Mobile
208.54.73.76    T-Mobile
208.54.83.96    T-Mobile
208.54.85.111   T-Mobile
```

```
Total Entries:9
```

6. If the ePDG IP address is not learned, identify the FQDN of ePDG and add the DNS pattern of the carrier. FQDN may not be matching with any of the default, built-in DNS patterns.
7. Place a few calls and execute the **show ucc client-info** and **show ucc call-info cdrs** commands or access the **Dashboard > UCC** page on the WebUI to view Wi-Fi call statistics and prioritization.

```
(host) [mynode] #show ucc client-info
```

Client Status:

```
-----  
Client IP      Client MAC      Client Name  ALG           Server(IP)    Registration State  
-----  
10.15.17.208  fc:c2:de:6c:01:9c Client       WiFi-Calling  T-Mobile      REGISTERED  
10.15.17.206  d8:bb:2c:51:16:b2 Client       WiFi-Calling  T-Mobile      REGISTERED
```

```
-----  
Call Status  AP Name  Flags  Device Type  Home_Agent  Foreign_Agent  
-----  
In-Call     4-105-2      Android  10.15.16.168  NA  
In-Call     2-105-1      Apple   10.15.16.168  NA
```

Total Client Entries:2

Flags: V - Visitor, A - Away, W - Wired, R - Remote, E - External

(host) [mynode] #show ucc call-info cdrs

Help: [C] - Metric calculated at the Controller

[A] - Metric calculated at the AP

CDR:

```
-----  
CDR ID  UCC Call ID  Client IP      Client MAC      Client Name  ALG           Dir  
Called to  
-----  
-----  
20      NA           10.15.17.206  d8:bb:2c:51:16:b2  NA           WiFi-Calling  NA  NA  
19      NA           10.15.17.208  fc:c2:de:6c:01:9c  NA           WiFi-Calling  NA  NA  
18      NA           10.15.17.208  fc:c2:de:6c:01:9c  NA           WiFi-Calling  NA  NA  
17      NA           10.15.17.206  d8:bb:2c:51:16:b2  NA           WiFi-Calling  NA  NA
```

```
-----  
Dur(sec)  Orig Time      Status  Reason      Call Type  Client Health  
-----  
82        Nov 24 23:21:31  ACTIVE  NA          Voice      44  
88        Nov 24 23:21:25  ACTIVE  NA          Voice      78  
93        Nov 24 23:16:19  SUCC    Terminated  Voice      71  
228       Nov 24 23:14:32  SUCC    Terminated  Voice      51
```

```
-----  
UCC Score[C]  UCC Score[A]  MOS  
-----  
NA            NA            NA  
NA            NA            NA  
NA            NA            NA  
NA            NA            NA
```

Total Entries:4



---

**UCC Score** and **MOS** value are not available for Wi-Fi Calling calls.

---

8. Execute the **show datapath session table** command on the managed device to ensure that media classification flags (**I** & **E**) are set for IPsec session destined to the ePDG IP address.
9. When a Wi-Fi Calling call is identified, the **I** and **E** flags are removed from the IPsec session and appropriate ToS and 802.1p values are set for this session, along with other flags like **V, H, P, T, O**. This occurs on the managed device.

10. When the call ends, ToS and 802.1p values are removed for the IPsec session along with the **V, H, P, T, O** flags, and the **I** and **E** flags are set. For a list of flags, execute the **show datapath session table** command on the managed device.

### Wi-Fi Calling Limitations

The following is a list of limitations in Wi-Fi Calling:

- Wi-Fi Calling is not supported for clients in split-tunnel and bridge-forwarding mode.
- WLAN and end to end quality metrics are not available for Wi-Fi Calling calls.
- Wi-Fi Calling calls may get dropped in the event of a cluster failover.
- Wi-Fi Calling calls do not get prioritized when Mobility Master is not reachable. This limitation does not apply for master controller deployment.
- If a Wi-Fi Calling client roams from one managed device to another, subsequent calls may not get prioritized until the client does a DNS query for carrier ePDG.
- Wi-Fi Calling is not identified and prioritized if NAT is enabled on the user VLAN. Wi-Fi Calling is not identified and prioritized if the corresponding sessions undergo NATting by the managed device.

### UCC Dashboard

The UCC dashboard gives a complete view of the UCC deployment in Mobility Master. The UCC dashboard has two levels of displaying statistics:

- [UCC Dashboard Aggregated Display](#)
- [UCC Dashboard Per Client Display](#)



---

Centralized visibility of UCC statistics in the wireless network is not available in master controller mode. Log in to each managed device to view the UCC statistics local to logged in managed device.

---

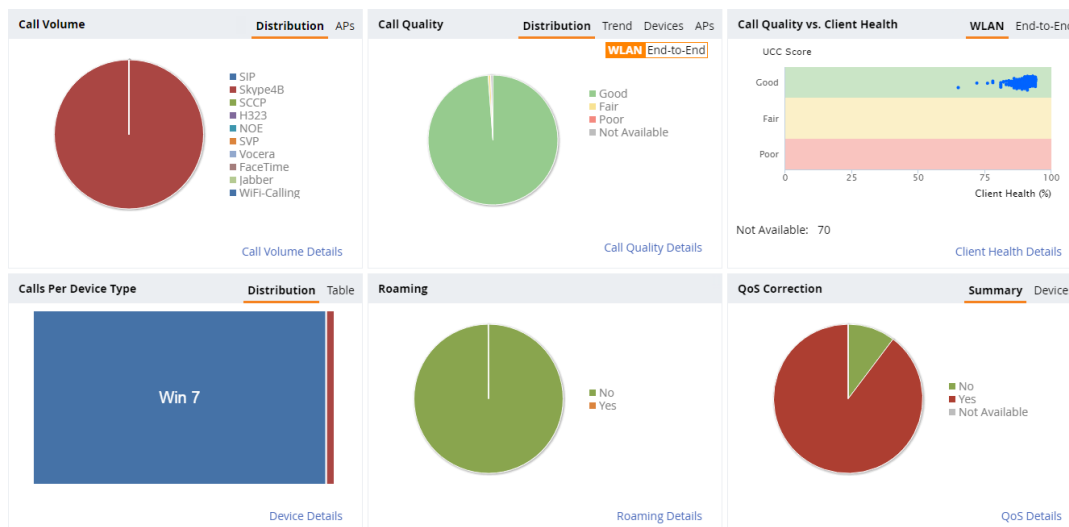
## UCC Dashboard Aggregated Display

The UCC Dashboard Aggregated Display shows an aggregated view of the UCC calls made in Mobility Master. The administrator can see a top-level view of the call quality assessment, and further drill-down into a specific view based on the analysis required.

### Chart View

Navigate to **Dashboard > UCC**. The UCC page displays the overall health (in graphical format) of the UCC deployment in Mobility Master as shown in [Figure 110](#).

**Figure 110** UCC Dashboard



Each graphical section of the UCC dashboard is explained as follows:

- **Call Volume** – This graph displays the total number of calls made based on the UCC application type. For example, SIP, Skype4B, SCCP, H.323, NOE, SVP, Vocera, FaceTime, Jabber, and WiFi-Calling. On clicking the **APs** tab, the graph displays the total number of calls per AP.
- **Call Quality** – This graph displays the AP-to-Client call quality under the **WLAN** tab and the end-to-end quality including wired and wireless legs of the call under the **End-to-End** tab. The number of UCC calls are categorized by the following call quality:
  - **Good**
  - **Fair**
  - **Poor**
  - **Not Available** – In the **WLAN** tab, short duration voice calls (less than 60 seconds), video calls, and file-transfer session are categorized as **Not Available**. In the **End-to-End** tab, short duration voice calls (less than 60 seconds), video calls, file-transfer, and app-sharing sessions are categorized as **Not Available**.The **Trend** tab displays the call quality over a period of time. The **Devices** tab categorizes the call quality based on the type of device. The **APs** tab displays the percentage of poor call quality per AP.
- **Call Quality vs. Client Health** – This graph displays the correlation between the VoIP call quality and the VoIP client health of every UCC call. This graph displays the UCC score under the **WLAN** tab and MOS under the **End-to-End** tab.



When VoIP calls are prioritized using media classification like Lync/Skype for Business, Apple Facetime and Wi-Fi Calling, the **End-to-End** call quality is not available. In addition, WLAN-based quality metrics including **Call Quality vs. Client Health** scatter plot are not available.

- **Calls Per Device Type** – This graph displays the calls made per device type. For example, Windows 7, Mac OS X, iPhone, or Android. On clicking the **Table** tab, Mobility Master lists the calls per device type in a tabular format. Any call that was made 6+ hours before is not listed here.
- **Roaming** – Roaming status of UCC clients. The status can be:
  - **No** – Number of calls where the client did not roam to a new AP during an active call.
  - **Yes** – Number of calls where the client has roamed to a new AP during an active call.
- **QoS Correction** – If the DSCP value of the Real-time Transport Protocol (RTP) packets sent by the client differs from corresponding priority value configured for the application, Mobility Master corrects this value as per the SSID profile definition and classifies the call as QoS corrected. This graph displays the number of UCC calls where Mobility Master has corrected the WMM-DSCP value for such calls. The QoS correction is categorized as:
  - **No** – No WMM-DSCP value correction.
  - **Yes** – WMM-DSCP value corrected by Mobility Master.
  - **Not Available** – WLAN short duration calls (less than 60 seconds) is categorized as **Not Available**.
 The **Devices** tab displays the QoS correction based on the type of device.

### Call Details View

To display an aggregated list of all the UCC call data metrics in Mobility Master, navigate to the **Dashboard > UCC** page of the WebUI and click any of the following hyperlinks of the Web page:

- Call Volume Details
- Call Quality Details
- Client Health Details
- Device Details
- Roaming Details
- QoS Details

[Figure 111](#) displays an aggregated list of all the UCC call data metrics on the managed devices.

**Figure 111** *Wireless Call List*

Wireless Call List (13702)											Prev 50	Next 50	Default Columns
CDR ID	UCC Call ID	IP Address	Station MAC	Client	UCC Client Id	Destination IP	Called Party	ALG	AP Name	Health(%)			
5,662	2,823	192.168.201.240	f0:7b:cb:3b:65:5c	uccsol2	uccsol2	192.168.201.246	uccsol3	Skype4B	UCC-AP115-1	100			
5,674	2,829	192.168.201.240	f0:7b:cb:3b:65:5c	uccsol2	uccsol2	192.168.201.246	uccsol3	Skype4B	UCC-AP115-1	100			
5,686	2,835	192.168.201.240	f0:7b:cb:3b:65:5c	uccsol2	uccsol2	192.168.201.246	uccsol3	Skype4B	UCC-AP115-1	100			
5,698	2,841	192.168.201.240	f0:7b:cb:3b:65:5c	uccsol2	uccsol2	192.168.201.246	uccsol3	Skype4B	UCC-AP115-1	100			

Wireless Call List (13704)													Prev 50	Next 50	Default Columns
CDR ID	WLAN					CONTROLLER									
	UCC Score [A] ...	UCC Band [A]	Delay (msec)	Jitter (msec)	Packet Loss(%)	UCC Score [C] ...	UCC Band [C]	Delay (msec)	Jitter (msec)	Packet Loss(%)	MOS	MOS Band			
5,662	85.97	Good	0.33	0	0.11	89.13	Good	0.09	3.97	0.34	4.23	Good			
5,674	84.22	Good	0.31	0	0	85.93	Good	0.08	8.1	0.69	4.25	Good			
5,686	84.49	Good	0.39	0	0	91.42	Good	0.1	0.3	0	4.26	Good			
5,698	85.16	Good	0.34	0.01	0.06	92.04	Good	0.08	0.3	0	4.27	Good			

Wireless Call List (13706)													Prev 50	Next 50	Default Columns
CDR ID	End-to-End											State			
	Delay (msec)	Jitter (msec)	Packet Loss(%)	Client WMM AC	Modified WMM AC	Client DSCP	Modified DSCP	Direction	Duration (sec)	Start Time					
5,662	6	2	0.07	5	6	40	46	OG	116	05:33:43 Jun 25, 2016	Success				
5,674	6	1	0.03	0	6	24	46	OG	116	05:36:21 Jun 25, 2016	Success				
5,686	5	3	0.07	5	6	40	46	OG	117	05:38:58 Jun 25, 2016	Success				
5,698	7	3	0.03	5	6	40	46	OG	117	05:41:36 Jun 25, 2016	Success				

Wireless Call List (13710)											
CDR ID	ie	Termination Reason	Application	Codec	ICH Status	Device	In Call Roam	QoS Correction	Connection Type	BSSID	Controller IP
5,662	:cess	Terminated	Voice	G722	Permit	Win 7	No	Yes	Wireless	aca3:1e:27:e4:b1	192.168.200.14
5,674	:cess	Terminated	Voice	G722	Permit	Win 7	No	Yes	Wireless	aca3:1e:27:e4:b1	192.168.200.14
5,686	:cess	Terminated	Voice	G722	Permit	Win 7	No	Yes	Wireless	aca3:1e:27:e4:b1	192.168.200.14
5,698	:cess	Terminated	Voice	G722	Permit	Win 7	No	Yes	Wireless	aca3:1e:27:e4:b1	192.168.200.14

VoIP calls made to/from clients outside Mobility Master are displayed in the **External Call List** pane. This pane lists all the external and wired client call CDRs. See [Figure 112](#).



External call list is available only when Lync/Skype for Business SDN API is configured on Mobility Master.

**Figure 112 External Call List**

External Call List (3 of 15376)												
CDR ID	UCC Call ID	IP Address	UCC Client Id	Destination IP	Called Party	Direction	ALG	State	Termination Reason	Application	MOS	MOS Band
15,352	7,666	10.16.126.16	uccsol6	192.168.201.249	uccsol7	IC	Skype4B	Success	Terminated	Voice	4.17	Good
15,360	7,670	10.16.126.16	uccsol6	192.168.201.249	uccsol7	OG	Skype4B	Success	Terminated	Voice	4.17	Good

External Call List (3 of 15378)												
End-to-End												
CDR ID	Delay (msec)	Jitter (msec)	Packet Loss(%)	Duration (sec)	Start Time	Codec	Connection Type	Client DSCP	Modified DSCP	Device	QoS Correction	
15,352	3	3	--	133	08:36:41 Jun 27, 2016	G722	External	--	--	Unknown	Not Available	
15,360	3	4	--	114	08:39:10 Jun 27, 2016	G722	External	--	--	Unknown	Not Available	

### UCC Dashboard Per Client Display

On the **Dashboard > Clients** page of the WebUI, clicking the client IP hyperlink displays the details page of the client. Click the **UCC** tab. This tab displays an aggregated list of UCC call data metrics of a client. See [Figure 113](#).

**Figure 113 UCC Client Page**

Charts <b>UCC</b>							
CDR ID	UCC Call ID	IP Address	Station MAC	Client	UCC Client Id	Destination IP	Called Party
13,716	6,848	192.168.201.230	5c:c5:d4:7d:c0:80	uccsol23	uccsol23	192.168.201.241	uccsol24
13,710	6,845	192.168.201.230	5c:c5:d4:7d:c0:80	uccsol23	uccsol23	192.168.201.241	uccsol24
13,704	6,842	192.168.201.230	5c:c5:d4:7d:c0:80	uccsol23	uccsol23	192.168.201.241	uccsol24

Charts <b>UCC</b>									
WLAN									
CDR ID	ALG	AP Name	Health(%)	UCC Score [A]...	UCC Band [A]	Delay (msec)	Jitter (msec)	Packet Loss(%)	UCC Score [C]
13,716	Skype4B	325-2	99	87.02	Good	0.34	0	0	87.85
13,710	Skype4B	325-2	99	86.43	Good	0.34	0	0	86.45
13,704	Skype4B	325-2	99	84.44	Good	0.58	0	0	85.65

Charts <b>UCC</b>									
CONTROLLER				End-to-End					
CDR ID	UCC Band [C]	Delay (msec)	Jitter (msec)	Packet Loss(%)	MOS	MOS Band	Delay (msec)	Jitter (msec)	Packet Loss(%)
13,716	Good	0.14	0.36	0	4.25	Good	10	1	--
13,710	Good	0.14	0.68	0.03	4.26	Good	3	4	--
13,704	Good	0.21	0.32	0.09	4.25	Good	3	1	0.05

Charts <b>UCC</b>								
CDR ID	Client WMM AC	Modified WMM AC	Client DSCP	Modified DSCP	Direction	Duration (sec)	Start Time	State
13,728	0	6	24	46	IC	59	20:44:30 Jun 26, 2016	Active
13,722	0	6	24	46	IC	117	20:41:52 Jun 26, 2016	Success
13,716	0	6	24	46	IC	117	20:39:14 Jun 26, 2016	Success

Charts <b>UCC</b> <span style="float: right;">Prev 50 <a href="#">Next 50</a>   Default Col</span>								
CDR ID	Termination Reason	Application	Codec	ICH Status	Device	In Call Roam	QoS Correction	Connection Type
13,728	NA	Voice	G722	Permit	Win 7	No	Yes	Wireless
13,722	Terminated	Voice	G722	Permit	Win 7	No	Yes	Wireless
13,716	Terminated	Voice	G722	Permit	Win 7	No	Yes	Wireless

Prev 50 [Next 50](#) | Default Colour

BSSID	Controller IP
ac:a3:1e:57:c4:90	192.168.200.15
ac:a3:1e:57:c4:90	192.168.200.15
ac:a3:1e:57:c4:90	192.168.200.15

Figure 114 displays the statistics of all the VoIP calls made by a particular client. This graph displays the AP-to-Client metrics under the **WLAN** tab and the end-to-end quality including wired and wireless legs of the call under the **End-to-End** tab.



When VoIP calls are prioritized using media classification like Apple Facetime and Wi-Fi Calling, the **End-to-End** call quality is not available. In addition, WLAN-based quality metrics including **Call Quality vs. Client Health** scatter plot are not available.

**Figure 114 All Calls**

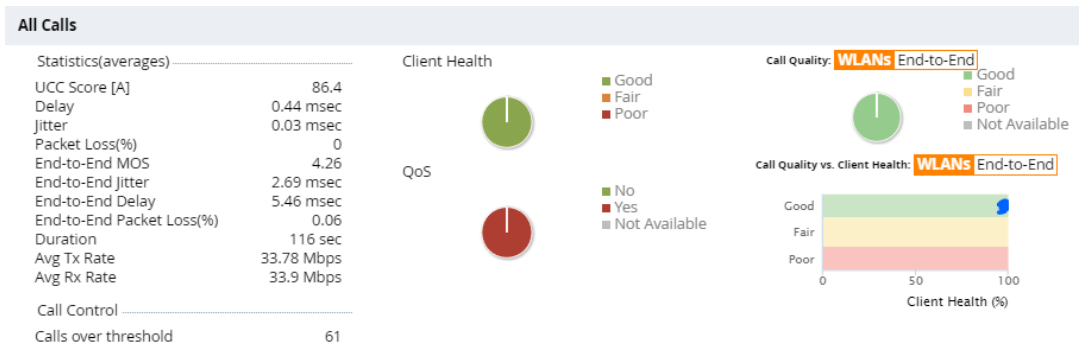


Figure 115 displays the VoIP call summary for a selected call of a client.

**Figure 115 Selected Call Summary**

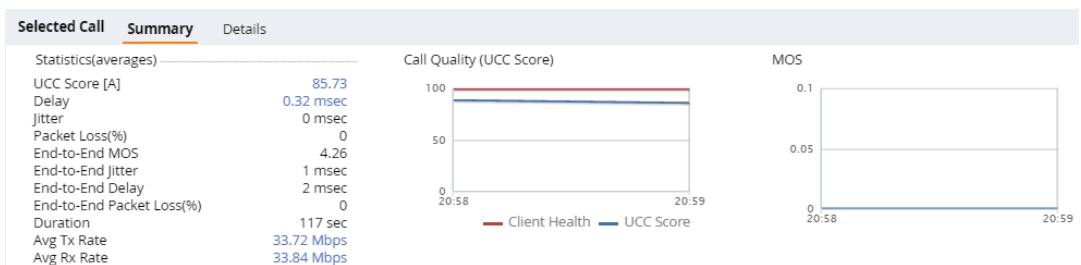


Figure 116 displays the VoIP call details for a selected call of a client.

**Figure 116 Selected Call Details**

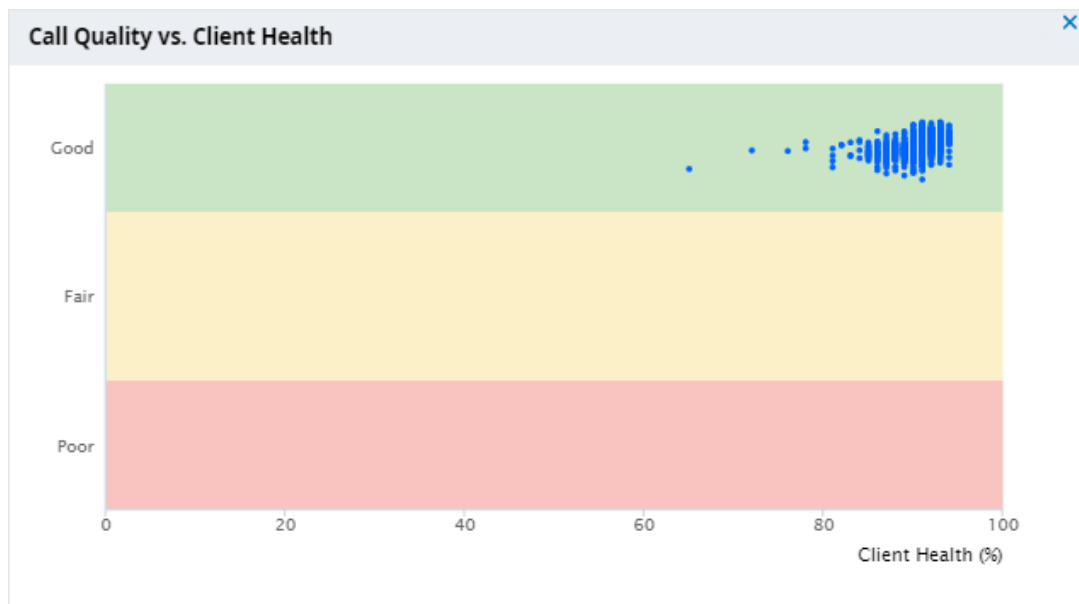
Selected Call		Summary		Details								
Timestamp	Health(%)	UCC Score L...	Delay (msec)	WLAN			End-to-End					
				Jitter (msec)	Packet Loss(%)	MOS	Delay (msec)	Jitter (msec)	Packet Loss(%)	Avg Tx Rate (Mbps)	Tx Drop(%)	
18:20:10	98	90.19	0.39	0	0.01	--	--	--	--	56.59	0.03	
18:19:22	96	90.19	0.39	0	0.01	--	--	--	--	56.84	0.03	
18:18:22	97	88.53	0.4	0.01	0.04	--	--	--	--	57.2	0.02	

Tx Retry(%)	Avg Rx Rate (Mbps)	Rx Retry(%)	SNR (dB)	Noise Floor (dBm)	Channel Busy	Channel Interference	Event
2.74	1,266.07	4.4	55	-93	3%	2	--
2.78	1,276.31	4.4	56	-93	4%	2	--
2.81	1,324.75	4.38	57	-91	3%	2	--

On the **Dashboard > Usage** page of the WebUI, the **Call Quality vs. Client Health** graph displays the correlation between the VoIP call quality (UCC-Band) and the VoIP client health of every UCC call. [Figure 117](#) displays the Call Quality vs Client Health graph.

**Figure 117 Call Quality vs. Client Health**



## UCC-AirWave Integration

The UCC-AirWave integration provides a multi-managed device visibility into the UCC solution across deployments. The Mobility Master sends raw UCC data using Application MONitoring (AMON) periodically. AirWave Management Platform (AMP) receives these AMON messages and uses this data to display user-friendly aggregated and per-client UCC statistics in AirWave. This helps the administrator to assess the overall health and troubleshoot UCC deployments in a multi-managed device environment. The UCC dashboard is supported in AirWave 8.0 onwards.

Follow these steps to get UCC data in AirWave from Mobility Master:

### Enabling UCC Data Collection in AirWave

To enable UCC data collection in the AirWave WebUI:

1. Navigate to the **AMP Setup > General** tab of the AirWave WebUI.
2. In the **Additional AMP Services** section, change the **Enable UCC Data Collection** option to **Yes**.



## Add AirWave as a Management Server in Mobility Master

You can add the default AirWave management server profile using the WebUI or CLI.



---

In master controller mode, add the default AirWave management server profile in the managed device.

---

### In the WebUI

To add AMP as a management server in Mobility Master:

1. In the **Mobility Master** node hierarchy, navigate to **Configuration > System > Airwave**.
2. In the **Connect to airwave** drop-down list, select **Yes**.
3. In the **Airwave IP address** text-box, enter the AirWave server IP.
4. In the **SNMP version** drop-down list, select the appropriate version.
5. Click **Submit**.
6. Navigate to **Configuration > System > More > General**.
7. In **MON Receivers**, click the newly added AirWave server.
8. In **Edit MON Receiver**, enter the following detail:
  - a. In the **Profile list** drop-down list, select the **default-amp** profile.
9. Click **Submit**.
10. Click **Pending Changes**.
11. In the **Pending Changes** window, select the check box and click **Deploy changes**.

### In the CLI

Execute the following command in the CLI to add AMP as a management server in Mobility Master:

```
(host) [mm] (config) #mgmt-server primary-server <primary-server-ip> profile default-amp
```

## Enable UCC Monitoring in Mobility Master

By default, UCC monitoring is disabled in Mobility Master. You can enable this setting using the WebUI or CLI.



---

In master controller mode, enable UCC monitoring in the managed device.

---

### In the WebUI

To enable UCC monitoring in Mobility Master:

1. In the **Mobility Master** node hierarchy, navigate to **Configuration > System > Profiles**.
2. In **All Profiles**, expand **Controller Profile > Mgmt Config**. Select the **default-amp** profile. This example uses the *default-amp* profile.
3. In the **Mgmt Config profile**, select the **UCC Monitoring** check box.
4. Click **Save**.
5. Click **Pending Changes**.
6. In the **Pending Changes** window, select the check box and click **Deploy changes**.

### In the CLI

Execute the following command in the CLI to enable UCC monitoring:

```
(host) [mm] (config) #mgmt-server profile default-amp  
(host) ^[mm] (Mgmt Config profile "default-amp") #uccmonitoring-enable
```

## Verify the Configuration

Execute the following command in the CLI to view the management server configuration profile:



---

In master controller mode, the **show** commands must be executed on the managed device.

---

```
(host) [mm] #show mgmt-server profile default-amp

Mgmt Config profile "default-amp" (Predefined (changed))
-----
Parameter                               Value
-----
Stats                                    Enabled
Tag                                       Enabled
Sessions                                 Enabled
Monitored Info - Add/Update              Disabled
Monitored Info - Deletion                Disabled
Monitored Info - Periodic Snapshot       Disabled
Wireless IDS Event Info                  Disabled
Misc                                      Enabled
Location                                 Enabled
UCC Monitoring                          Enabled
AirGroup Info                            Disabled
Inline DHCP stats                         Enabled
Inline AP stats                           Enabled
Inline Auth stats                         Enabled
Inline DNS stats                          Enabled
```

Execute the following command in the CLI to view the current Mobility Master configuration with respect to the management server configuration profile:



---

In master controller mode, execute this command on the managed device.

---

```
(host) [mm] #show running-config | include mgmt-server
Building Configuration...
mgmt-server primary-server 192.0.2.1 profile default-amp
mgmt-server profile "default-ale"
mgmt-server profile "default-amp"
mgmt-server profile "default-controller"
```

The UCC-AirWave integration is complete.

## UCC Limitations

- Voice ALGs are not supported when voice clients are behind a NAT device.
- Media classification does not work when user VLAN has IP NAT configured.
- When using media classification or signaling protocols, UCC score, jitter, delay, and packet loss is calculated only for voice RTP streams. These metrics are not available for video streams.
- Media classification does not work in split-tunnel forwarding mode.
- When VoIP calls are prioritized using media classification, end-to-end call quality metrics such as Mean Opinion Score (MOS), delay, jitter, and packet loss are not available.
- UCC score is calculated for voice calls and desktop-sharing sessions only.
- For Lync/Skype for Business calls, MOS is generated only for voice streams. Lync/Skype for Business server does not generate MOS for video streams, desktop-sharing, and file-transfer sessions.

## Upgrade UCM Loadable Service Module

Starting from ArubaOS 8.x, UCM runs as a loadable service module on Mobility Master. You can upgrade the UCM service module without rebooting Mobility Master. For more information, see [Loadable Service Module on page 870](#).



---

Loadable service module is not supported in master controller mode.

---

## Understanding Extended Voice and Video Features

This section describes the other voice and video-related functionalities that are available on Mobility Master.

### Enabling WPA Fast Handover

In the 802.1X authentication profile, the Wi-Fi Protected Access (WPA) fast handover feature allows certain WPA clients to use a pre-authorized PMK, significantly reducing handover interruption. Check with the manufacturer of your handset to see if this feature is supported. This feature is disabled by default.



---

This feature supports WPA clients, while opportunistic key caching (also configured in the 802.1X Authentication profile) supports WPA2 clients.

---

#### In the WebUI

1. In the **Managed Network** node hierarchy, navigate to **Configuration > System > Profiles**.
2. In **All Profiles**, expand **Wireless LAN > 802.1X Authentication**. Select the **default** profile. This example uses the *default* profile.
3. In **802.1X Authentication Profile**, select the **WPA-Fast-Handover** check box.
4. Click **Save**.
5. Click **Pending Changes**.
6. In the **Pending Changes** window, select the check box and click **Deploy changes**.

#### In the CLI

```
(host) [md] (config) #aaa authentication dot1x default
(host) ^[md] (802.1X Authentication Profile "default") #wpa-fast-handover
```

For deployments where there are expected to be considerable delays between the managed device and APs (for example, in a remote location where an AP is not in range of another AP) you can increase the value for the bootstrap threshold in the AP System profile to minimize the chance of the AP rebooting due to temporary loss of connectivity with the managed device.

### Scanning VoIP-aware ARM

ARM scanning on an AP during a call affects the voice quality. You can pause the ARM scanning on the AP when a call is active by turning on the VoIP-aware ARM scanning support to avoid voice quality issues. You can use the WebUI or CLI to enable VoIP-aware ARM scanning in the ARM profile.

#### In the WebUI

1. In the **Managed Network** node hierarchy, navigate to **Configuration > System > Profiles**.
2. In **All Profiles**, expand **RF Management > Adaptive Radio Management (ARM)**. Select the **default-a** profile. This example uses the *default-a* profile.
3. In **Adaptive Radio Management (ARM) profile**, select the **VoIP Aware Scan** check box.

4. Click **Save**.
5. Click **Pending Changes**.
6. In the **Pending Changes** window, select the check box and click **Deploy changes**.

For additional information on configuring an Adaptive Radio Management profile, see [Configuring ARM Profiles on page 453](#).

### In the CLI

```
(host) [md] (config) #rf arm-profile default-a
(host) ^[md] (Adaptive Radio Management (ARM) profile "default-a") #voip-aware-scan
```

## Working with Voice over Remote Access Point

Voice traffic support is enhanced on the split-tunnel forwarding mode over a Remote Access Point (RAP). The voice traffic management for remote and local users are done on Mobility Master. However, the sessions are created differently for both users. For remote users, the sessions are created on the RAP and for local users, the sessions are created on Mobility Master. This enhancement provides the following support for the voice traffic in the split tunnel over remote access point:

- Voice traffic QoS is consistent for both local and remote users.
- All voice ALGs work reliably in split-tunnel forwarding mode when the PBX traffic is destined to flow through the corporate network.
- Provides voice statistics and counters for remote voice clients in the split-tunnel forwarding mode.

The **Flags** parameter in the **show ucc client-info** command is updated to indicate remote users:

```
(host) [mynode] #show ucc client-info
```

Client Status:

```
-----
Client IP      Client MAC      Client Name  ALG      Server (IP)  Registration State  Call
Status
-----
-----
192.0.2.22     00:23:33:41:c8:b8  Alex        SIP      192.0.2.1    REGISTERED          Idle
192.0.2.26     24:77:03:9a:6c:dc  John        Jabber   192.0.2.3    REGISTERED          Idle
```

```
AP Name  Flags  Device Type  Home Agent  Foreign Agent
-----
          AP-105  R           OS X        192.0.2.25  NA
          AP-135                Win 7        192.0.2.25  NA
```

Total Client Entries:2

Flags: V - Visitor, A - Away, W - Wired, **R - Remote**, E - External

## Understanding Battery Boost

Battery boost is an optional feature that can be enabled for any SSIDs that support voice traffic. This feature converts all broadcast and multicast traffic to unicast before delivery to the client. Enabling battery boost on an SSID allows you to set the Delivery Traffic Indication Map (DTIM) interval from 10 to 100 (the previous allowed values were 1 or 2), equating to 1,000 to 10,000 milliseconds. This longer interval keeps associated wireless clients from activating their radios for multicast indication and delivery, leaving them in power-save mode longer, and thus lengthening battery life. The DTIM configuration is performed on the WLAN, so no configuration is necessary on the client.

An associated parameter available on some clients is the Listening Interval (LI). This defines the interval (in number of beacons) after which the client must wake to read the Traffic Indication Map (TIM). The TIM indicates whether there is buffered unicast traffic for each sleeping client. With battery boost enabled, the DTIM is increased but multicast traffic is buffered and delivered as unicast. Increasing the LI can further increase battery life, but can also decrease client responsiveness.



---

Do not enable battery boost if your network includes Polycom SpectraLink devices that use the Push-to-Talk feature.

---

You can use the WebUI or CLI to enable the battery boost feature and set the DTIM interval in the SSID profile.

### In the WebUI

1. In the **Managed Network** node hierarchy, navigate to **Configuration > System > Profiles**.
2. In **All Profiles**, expand **Wireless LAN > SSID**. Select the **default** profile.  
This example uses the *default* profile.
3. In **SSID Profile**, change the **DTIM Interval** to a longer interval time.
4. Select the **Battery Boost** check box.
5. Click **Save**.
6. Click **Pending Changes**.
7. In the **Pending Changes** window, select the check box and click **Deploy changes**.

### In the CLI

Use the following commands:

```
(host) [md] (config) #wlan ssid-profile defaultwlan ssid-profile <profile>
(host) ^[md] (SSID Profile "default") #battery-boost
(host) ^[md] (SSID Profile "default") #dtim-period <dtim-period>
```

## Enabling LLDP

Link Layer Discovery Protocol (LLDP), is a Layer-2 protocol that allows network devices to advertise their identity and capabilities on a LAN. Wired interfaces on Aruba APs support LLDP by periodically transmitting LLDP Protocol Data Units (PDUs) comprised of selected Type-Length-Value (TLV) elements. For a complete list of supported, see [Table 221](#) and [Table 222](#).

LLDP-MED (Media Endpoint Devices) is an extension to LLDP that supports interoperability between VoIP and video streaming devices and other networking clients. LLDP-MED network policy discovery lets end-points and network devices advertise the VLAN, priority levels, and DSCP values used by a voice or video application.

You can use the WebUI or CLI to configure the LLDP profile and select the TLVs to be sent by the AP.

### In the WebUI

1. In the **Managed Network** node hierarchy, navigate to **Configuration > System > Profiles**.
2. In **All Profiles**, expand **AP > AP LLDP**. Select the **default** profile.  
This example uses the *default* profile.
3. The AP LLDP profile is divided into two tabs, **General** and **Advanced**. The **General** tab displays only those configuration settings that often need to be adjusted to suit a specific network. The **Advanced** tab shows all configuration settings, including settings that do not need frequent adjustment or should be kept at their default values. Both basic and advanced settings are described in [Table 221](#).

**Table 221: LLDP Profile Configuration Parameters**

Parameter	Description
<b>General</b>	
PDU Transmission	Select this check box to enable LLDP PDU Transmission. PDU Transmission is enabled by default.
Reception of LLDP PDUs	Select this check box to enable LLDP PDU Reception. PDU Reception is enabled by default.
<b>Advanced</b>	
Transmit Interval (seconds)	The interval between LLDP TLV transmission seconds. Range: 1-3600, seconds and Default: 30 seconds.
Transmit hold multiplier	<p>The Transmit hold multiplier is a value that is multiplied by the transmit interval to determine the number of seconds to cache learned LLDP information before that information is cleared.</p> <p>If the Transmit hold multiplier value is set at its default value of 4, and the Transmit interval is at its default value of 30 seconds, then learned LLDP information will be cached for 4x30 seconds, or 120 seconds.</p>
Optional TLVs	<p>Select the check boxes in this section to select the optional TLVs the AP interface sends in LLDP PDUs. The AP will send all optional TLVs by default.</p> <ul style="list-style-type: none"> <li>• <b>port-description:</b> transmit a TLV that gives a description of the AP's wired port in an alphanumeric format.</li> <li>• <b>system-description:</b> transmit a TLV that describes the AP's model number and software version.</li> <li>• <b>system-name:</b> transmit a TLV that sends the AP name or wired MAC address.</li> <li>• <b>capabilities:</b> transmit the system capabilities TLV to indicate which capabilities are supported by the AP.</li> <li>• <b>management-address:</b> transmit a TLV that indicates the AP's management IP address, in either IPv4 or IPV6 format.</li> </ul>

Parameter	Description
802.1 TLVs	<p>Select the check boxes in this section to select the 802.1 TLVs the AP interface sends in LLDP PDUs. The AP will send all 802.1 TLVs by default:</p> <ul style="list-style-type: none"> <li>• <b>port-vlan:</b> transmit the LLDP 802.1 port VLAN TLV. If the native VLAN is configured on the port, the port-vlan TLV will send that value, otherwise it will send a value of "0".</li> <li>• <b>vlan-name:</b> transmit the LLDP 802.1 VLAN name TLV. The AP sends a value of "Unknown" for VLAN 0, or "VLAN &lt;number&gt;" for all non-zero VLAN numbers.</li> </ul>
802.3 TLVs	<p>Select the check boxes in this section to select the 802.3 TLVs the AP interface sends in LLDP PDUs. The AP will send all 802.3 TLVs by default:</p> <ul style="list-style-type: none"> <li>• <b>mac:</b> transmit the 802.3 MAC/PHY Configuration/Status TLV to indicate the AP interface's duplex and bit rate capacity and current duplex and bit rate settings.</li> <li>• <b>link-aggregation:</b> transmit the 802.3 link aggregation TLV to indicate that link aggregation is not supported.</li> <li>• <b>mfs:</b> transmit the 802.3 Maximum Frame Size (MFS) TLV to show the AP's maximum frame size capability.</li> <li>• <b>power:</b> transmit the 802.3 Power Via media dependent interface (MDI) TLV to show the power support capabilities of the AP interface.</li> </ul> <p>This parameter is supported by the RAP-3WNP and 130 Series only.</p>
LLDP-MED TLVs	<p>Once you have associated an LLDP-MED Network policy profile with this LLDP profile, you can click the check boxes in this section to select the LLDP-MED TLVs the AP interface sends in LLDP PDUs. The AP does not send any LLDP-MED TLVs by default:</p> <ul style="list-style-type: none"> <li>• <b>capabilities:</b> transmit the LLDP-MED capabilities TLV. The AP will automatically send this TLV if it sends any other LLDP-MED TLVs.</li> <li>• <b>inventory:</b> transmit the LLDP-MED inventory TLV.</li> <li>• <b>network-policy:</b> transmit the LLDP-MED network-policy TLV.</li> </ul> <p><b>NOTE:</b> The TLVs in this section cannot be enabled unless you have associated an LLDP-MED Network policy profile</p>

- To associate an LLDP-MED network policy profile with the LLDP profile and the LLDP-MED TLVs to be sent by the AP interface, click the **LLDP-MED network policy** that appears under the **AP LLDP > default** profile in the profile list.
- If the LLDP profile does not currently reference an LLDP-MED Network Policy profile, you must associate an LLDP-MED Network Policy profile with the LLDP profile before you can configure any LLDP-MED settings. In **AP LLDP-MED Network Policy Profile**, click the + icon to link an LLDP-MED Network Policy profile.
- Click **Save**.
- Click **Pending Changes**.
- In the **Pending Changes** window, select the check box and click **Deploy changes**.

### In the CLI

```
(host) [md] (config) #ap lldp profile <profile>
(host) ^[md] (AP LLDP Profile "<profile>") #clone <profile>
(host) ^[md] (AP LLDP Profile "<profile>") #dot1-tlvs [port-vlan|vlan-name]
(host) ^[md] (AP LLDP Profile "<profile>") #dot3-tlvs [link-
aggregation|mac|mfs|power]
(host) ^[md] (AP LLDP Profile "<profile>") #lldp-med-network-policy-profile <profile>
```

```

(host) ^[md] (AP LLDP Profile "<profile>") #lldp-med-tlvs
[capabilities|inventory|network-policy]
(host) ^[md] (AP LLDP Profile "<profile>") #no ...
      (host) ^[md] (AP LLDP Profile "<profile>") #optional-tlvs
[capabilities|management-address|port-description|system-description|system-name]
(host) ^[md] (AP LLDP Profile "<profile>") #receive
(host) ^[md] (AP LLDP Profile "<profile>") #transmit
(host) ^[md] (AP LLDP Profile "<profile>") #transmit-hold <transmit-hold>
      (host) ^[md] (AP LLDP Profile "<profile>") #transmit-interval <transmit-interval>

```

You can use the WebUI or CLI to configure the LLDP-MED profile.

### In the WebUI

1. In the **Managed Network** node hierarchy, navigate to **Configuration > System > Profiles**.
2. In **All Profiles**, expand **AP > AP LLDP-MED Network Policy**. Select the **default** profile.  
This example uses the *default* profile.
3. The **LLDP-MED Network Policy** profile is divided into two tabs, **General** and **Advanced**. The **General** tab displays only those configuration settings that often need to be adjusted to suit a specific network. The **Advanced** tab shows all configuration settings, including settings that do not need frequent adjustment or should be kept at their default values. Both basic and advanced settings are described in [Table 222](#).



**Table 222: LLDP-MED Network Policy Profile Configuration Parameters**

Parameter	Description
<b>General</b>	
LLDP-MED application type	<p>Click the LLDP-MED application type drop-down list and select the application type managed by this profile.</p> <ul style="list-style-type: none"> <li>• <b>guest-voice:</b> if the AP services a separate voice network for guest users and visitors.</li> <li>• <b>guest-voice-signaling:</b> if the AP is part of a network that requires a different policy for guest voice signaling than for guest voice media. Do not use this application type if both the same network policies apply to both guest voice and guest voice signaling traffic.</li> <li>• <b>softphone-voice:</b> if the AP supports voice services using softphone software applications on devices such as PCs or laptops.</li> <li>• <b>streaming-video:</b> if the AP supports broadcast or multicast video or other streaming video services that require specific network policy treatment. This application type is not recommended for video applications that rely on TCP with buffering.</li> <li>• <b>video-conferencing:</b> if the AP supports video conferencing equipment that provides real-time, interactive video/audio services.</li> <li>• <b>video-signaling:</b> if the AP is part of a network that requires a different policy for video signaling than for the video media. Do not use this application type if both the same network policies apply to both video and video signaling traffic.</li> <li>• <b>voice:</b> if the AP services IP telephones and other appliances that support interactive voice services. This is the default application type.</li> <li>• <b>voice-signaling:</b> Select this application type if the AP is part of a network that requires a different policy for voice signaling than for the voice media. Do not use this application type if both the same network policies apply to both voice and voice signaling traffic.</li> </ul>
LLDP-MED application VLAN	Specify a VLAN by VLAN ID (0-4094) or VLAN name.
LLDP-MED application VLAN tagging	<p>Select this check box if the LLDP-MED policy applies to a to a VLAN that is tagged with a VLAN ID or untagged. The default value is untagged.</p> <p><b>NOTE:</b> When an LLDP-MED network policy is defined for use with an untagged VLAN, then the L2 priority field is ignored and only the DSCP value is used.</p>
<b>Advanced</b>	
LLDP-MED application Layer-2 priority	Specify a 802.1p priority level for the specified application type, by entering a value from 0 to 7, where 0 is the lowest priority level and 7 is the highest priority.
LLDP-MED application Differentiated Services Code Point	Select a DSCP priority value for the specified application type by specifying a value from 0 to 63, where 0 is the lowest priority level and 63 is the highest priority.

4. Click **Save**.
5. Click **Pending Changes**.

6. In the **Pending Changes** window, select the check box and click **Deploy changes**.

### In the CLI

```
(host) [md] (config) #ap lldp med-network-policy-profile <profile>
      (host) ^[md] (AP LLDP-MED Network Policy Profile "default") #application-type
{guest-voice|guest-voice-signaling|softphone-voice|streaming-video|video-conferencing|video-
signaling|voice|voice-signaling}
(host) ^[md] (AP LLDP-MED Network Policy Profile "default") #clone <profile>
(host) ^[md] (AP LLDP-MED Network Policy Profile "default") #dscp <dscp>
(host) ^[md] (AP LLDP-MED Network Policy Profile "default") #l2-priority <l2-priority>
(host) ^[md] (AP LLDP-MED Network Policy Profile "default") #no ...
(host) ^[md] (AP LLDP-MED Network Policy Profile "default") #tagged
(host) ^[md] (AP LLDP-MED Network Policy Profile "default") #vlan <vlan>
```

The following commands create a LLDP MED network policy profile for streaming video applications and marks streaming video as high-priority traffic:

```
(host) [md] (config) #ap lldp med-network-policy-profile vid-stream
      (host) ^[md] (AP LLDP-MED Network Policy Profile "vid-stream") #dscp 48
(host) ^[md] (AP LLDP-MED Network Policy Profile "vid-stream") #l2-priority 6
(host) ^[md] (AP LLDP-MED Network Policy Profile "vid-stream") #tagged
(host) ^[md] (AP LLDP-MED Network Policy Profile "vid-stream") #vlan 10
```

Next, the LLDP MED network policy profile is assigned to an LLDP profile, and the LLDP profile is associated with an AP wired-port profile:

```
(host) [md] (config) #ap lldp profile videol
(host) ^[md] (AP LLDP Profile "videol") #lldp-med-network-policy-profile vid-stream
(host) ^[md] (AP LLDP Profile "videol") #!
(host) ^[md] (config) ap wired-port-profile corp2
(host) ^[md] (AP wired port profile "corp2")lldp-profile videol
```

AirGroup is a unique enterprise-class capability that leverages zero configuration networking to allow mobile device technologies, like the AirPrint wireless printer service or the AirPlay mirroring service, to communicate over a complex access network topology.



---

Starting from ArubaOS 8.0, AirGroup runs only on Mobility Master or stand-alone controllers. AirGroup does not run on managed devices.

---

This section describes the following AirGroup topics:

- [Zero Configuration Networking on page 939](#)
- [AirGroup Solution on page 940](#)
- [AirGroup in ArubaOS 8.0 on page 940](#)
- [AirGroup Value Additions in Mobility Master on page 941](#)
- [AirGroup Services on page 941](#)
- [AirGroup Deployment Models on page 942](#)
- [AirGroup Changes from ArubaOS 6.x on page 942](#)
- [AirGroup Features Deprecated in ArubaOS 8.0 on page 943](#)
- [AirGroup Features on page 943](#)
- [Prerequisites to Enable AirGroup on page 950](#)
- [Configuring AirGroup on page 954](#)
- [Best Practices and Limitations on page 985](#)
- [Troubleshooting and Log Messages on page 987](#)

## Zero Configuration Networking

Zero configuration networking is a technology that enables service discovery, address assignment, and name resolution for desktop computers, mobile devices, and network services. It is designed for flat, single-subnet IP networks such as the home network of a user.

The suite of protocols introduced by Apple® for zero configuration networking over IP is referred to as Bonjour®. Bonjour is supported by most of the Apple product lines including the Mac OS X® operating system, iPhone®, iPod®, iPad®, Apple TV® and AirPort Express®. Bonjour is also included within popular software programs such as Apple iTunes®, Safari, and iPhoto®. Bonjour® can be installed on computers running Microsoft Windows® and is supported by most new network-capable printers.

Bonjour locates devices such as printers, other computers, and the services offered by these devices by using multicast Domain Name System (mDNS) service records. Bonjour uses the link-scope multicast addresses, so each query or advertisement is limited to a specific VLAN. In large universities and enterprise networks, Bonjour capable devices connect to the network using different VLANs. As a result, an iPad on one enterprise VLAN will not be able to discover the Apple TV that resides on another VLAN. Broadcast and multicast traffic is filtered out of a wireless LAN network in an effort to reduce network traffic. This inhibits Bonjour (mDNS) services, which rely on multicast traffic.

ArubaOS supports Digital Living Network Alliance (DLNA); a network standard that is derived from UPnP (Universal Plug and Play) in addition to the mDNS protocol. DLNA uses the Simple Service Discovery Protocol (SSDP) for service discovery on the network. DLNA provides the ability to share digital media between

multimedia devices, like Windows and Android, similar to how mDNS supports Zero Configuration Networking to Apple devices and services. ArubaOS ensures that DLNA seamlessly works with the current mDNS implementation. All the features and policies that are applicable to mDNS are extended to DLNA. This ensures full interoperability between compliant devices.

## AirGroup Solution

AirGroup leverages key elements of Aruba's solution portfolio including the ArubaOS and Aruba ClearPass Policy Manager.

AirGroup performs the following functions:

- Enables users to discover network services across IP subnet boundaries in enterprise wireless and wired networks.
- Enables users to access the available AirGroup services such as AirPrint and AirPlay.
- Permits users to access conference room Apple TV during presentations, based on group-based access privileges.
- Provides and maintains seamless connectivity of clients and services across VLANs and SSIDs. It minimizes the mDNS traffic across the wired and wireless network, thereby preserving wired network bandwidth and WLAN airtime.

With AirGroup:

- An AirGroup operator—an end user such as a student can register personal devices. The devices registered by the operator can then automatically be shared with each other.
- Each user can create a user group, such as friends and roommates with whom the user can share the registered devices.
- AirGroup administrators can register and manage an organization's shared devices such as printers or conference room Apple TV. The administrator can grant global access to each device, or limit access based on user name, role, or location.

This chapter provides configuration information for network administrators to enable AirGroup and ClearPass Policy Manager and to register devices with ClearPass Guest.

AirGroup also enables context awareness for services across the network:

- AirGroup is aware of personal devices. An Apple TV in a dorm room, for example, can be associated with the student who owns it.
- AirGroup is aware of shared resources, such as an Apple TV in a meeting room, a printer available to multiple users, or AirPlay in a classroom where a laptop screen is projected on HDTV monitor.
- AirGroup is location aware. For example, an iPad is presented with the closest printer instead of all the printers in a building. If a user in a conference room wants to use an Apple TV to project a MacBook screen on an HDTV monitor, the location-aware AirGroup shows the Apple TV that is closest to that user.

## AirGroup in ArubaOS 8.0

Starting from ArubaOS 8.0, AirGroup runs as a Loadable Service Module (LSM) on Mobility Master.

The AirGroup application uses the OpenFlow infrastructure to receive the signaling messages from the managed devices and also installs/deletes flows on the managed devices for the calls.

## AirGroup Value Additions in Mobility Master

AirGroup provides the following value additions in Mobility Master:

- Enables AirGroup to run as a service on Mobility Master and managed devices do not run the same. This results in better scalability.
- AirGroup devices are maintained on Mobility Master in a centralized manner. The AirGroup domain feature is not required for visibility across managed devices.
- AirGroup supports LSM infrastructure for upgrading to a newer version independent of ArubaOS version.
- AirGroup provides aggregation of statistical information at a centralized entity.

## AirGroup Services

An administrator may enable or disable individual AirGroup services by using the WebUI or CLI. The following AirGroup services are pre-configured and are available as part of the factory default configuration:

- AirPlay
- AirPrint
- Allowall
- Amazon TV
- Chat or Messages
- DIAL
- DLNA Media
- DLNA Print
- GoogleCast
- iTunes
- RemoteMgmt
- Sharing
- Static

The following AirGroup services are enabled by default:

- AirPlay — The AirPlay service allows wireless streaming of music, video, and slide shows from iOS device to Apple TV and other devices that support the AirPlay feature.
- AirPrint — The AirPrint service allows to print from an iPad, iPhone, or iPod Touch directly to any AirPrint compatible printers.
- DIAL — Wi-Fi-enabled streaming devices like Google Chromecast, Roku, Amazon FireTV, and more advertise the Discovery and Launch (DIAL) protocol for clients to search for an available device on a wireless network. Once a device is discovered, the protocol synchronizes information on how to connect to the device. The streaming device connects to a television through an HDMI port to wirelessly streams video and music content to the TV from a smart phone (both Android and iOS), tablet, laptop, or desktop computer devices.

The following AirGroup services are disabled by default:

- Chat or Messages — The Chat or Messages service provides messaging on Apple devices uses this service.
- DLNA Media — Applications such as Windows Media Player use this service to browse and play media content on a remote device.
- DLNA Print — This service is used by printers which support DLNA.
- GoogleCast — Google Chromecast uses this service to stream video and music content from a smart phone to a TV screen using a wireless network.

- iTunes — iTunes service is used by iTunes Wi-Fi sync and iTunes home-sharing applications across all Apple devices. For best practices, see the [Apple iTunes Wi-Fi Synchronization and File Sharing on page 985](#).
- RemoteMgmt — Use this service for remote login, remote management, and FTP utilities on Apple devices.
- Sharing — Applications such as disk sharing and file sharing, use the service ID that are part of this service on one or more Apple devices. For best practices, see the [Apple iTunes Wi-Fi Synchronization and File Sharing on page 985](#).



---

AirGroup also supports custom and allowall services. For more information, see [Configuring AirGroup on page 954](#).

---

## AirGroup Deployment Models

AirGroup supports following deployment models:

- 7200 Series Master Controller Mode
- Mobility Master-Managed Device
- Stand-alone Controller

### 7200 Series Master Controller Mode

ArubaOS 8.0.1.0 supports 7200 Series controllers to run as a master controller. In 7200 Series master controller mode deployment model, AirGroup configuration is allowed on the managed devices and device nodes (device nodes are located within managed devices). However, server-based policy configuration is allowed only on device nodes. This deployment model does not support centralized AirGroup dashboard.

### Mobility Master-Managed Device

Mobility Master is the root of a network hierarchy. A single Mobility Master oversees a number of managed devices that can be co-located or off-campus. In Mobility Master-Managed Device deployment model, all AirGroup configuration is allowed only on the Mobility Master.

### Stand-alone Controller

AirGroup supports domains for stand-alone controllers. This feature, for example, allows iPad users on one stand-alone controller to discover Apple TV available on another stand-alone controller if both stand-alone controllers are part of the same domain. In stand-alone controller deployment model, all AirGroup configuration is allowed only on the Mobility Master.

## AirGroup Changes from ArubaOS 6.x

The following is a list of AirGroup changes from ArubaOS 6.x to ArubaOS 8.0:

- Ability to define more than one hop for ap-name based location policy.
- Support for disallowed named VLAN policy for users and servers.
- Extension of support for disallowed VLAN policy for users in addition to servers.
- Extension of support for disallowed role policy for servers in addition to users.
- Enhanced visibility of servers, users, traffic trend, and bandwidth utilization in Dashboard.
- Support for wired users.

## AirGroup Features Deprecated in ArubaOS 8.0

The following AirGroup features are deprecated in ArubaOS 8.0:

- Domain is no longer supported in Mobility Master-Managed Device topology. Domain is supported in 7200 Series Master Controller Mode and stand-alone controller topology.
- Global credits mechanism is removed.
- Active wireless discovery mechanism is removed.
- Location discovery parameter is deprecated.

## AirGroup Features

This section describes the following AirGroup features:

- [Number of Hops on page 943](#)
- [Named VLANs on page 943](#)
- [Dashboard on page 944](#)
- [Auto-Association and AirGroup Policy on page 944](#)
- [ClearPass Policy Manager and ClearPass Guest on page 944](#)
- [Group-Based Device Sharing on page 945](#)
- [IPv6 Support on page 945](#)
- [Bluetooth-Based Discovery and AirGroup on page 946](#)
- [DLNA UPnP Support on page 946](#)
- [Domain for 7200 Series Master Controller Mode and Stand-alone Controller on page 946](#)
- [mDNS AP VLAN Aggregation on page 946](#)
- [mDNS Multicast Response Propagation on page 947](#)
- [mDNS Static Records on page 948](#)
- [Scalability on page 948](#)

### Number of Hops

To support location based sharing, AirGroup allows an administrator to define the number of hops or the neighborhood of access points an AirGroup server is shared with. This allows an administrator to deploy and administer AirGroup in large physical places with many access points and clients. An administrator can define the hop count as 1, 2, 3, or no neighborhood.

The hop count policy is available for per server AirGroup policy. Service based auto-associate policy considers single hop RF neighbor APs for visibility of server. The hop count policy is allowed for a maximum of 10 servers when the hop count is 2 or 3. The hop count policy is not available in ClearPass Policy Manager. The multi-hop neighbor table for a server is refreshed every 30 minutes. If an access point is connected or removed in 2 or 3 hop neighborhood of the server, it takes up to 30 minutes for the policy to apply this change. To configure number of hops, see [Configuring AirGroup on page 954](#)

### Named VLANs

Use a named VLAN (which can have a VLAN or a VLAN pool) to define and share relationships in a Mobility Master. For example, a named VLAN "faculty" can have access to AirPlay and AirPrint services whereas another named VLAN "students" can have access to only the AirPrint service. Only 100 VLAN IDs can be configured per named VLAN.

Named VLANs can be disallowed. The disallowed VLANs can be configured at AirGroup service level or AirGroup global level.

VLAN IDs can be disallowed. The disallowed VLAN IDs can be configured at AirGroup service level and AirGroup global level. The disallow VLAN takes only a single VLAN ID. Any value beyond the range of 1 to 4093 is considered as a named VLAN value.

When global disallow server is configured for a VLAN, then records from any server on this VLAN are not cached.

When global disallow user is configured for a VLAN, then response is not sent from a stand-alone controller for any query from this VLAN.

Roles can be disallowed for users and servers. The disallowed role for users and servers can be configured only at AirGroup service level.

To configure named VLANs, see [Configuring AirGroup on page 954](#)

## Dashboard

The AirGroup dashboard provides enhanced visibility into AirGroup. The combined view of all AirGroup devices and usage in the network is available under the AirGroup dashboard of every node in the hierarchy. For additional information, see [AirGroup on page 740](#). Centralized visibility is available only in Mobility Master-Managed Device topology. 7200 Series Master Controller Mode topology supports only Individual device level visibility.

## Auto-Association and AirGroup Policy

Auto-association allows AirGroup users to discover nearby AirGroup servers. Auto-association ensures that all the AirGroup users associated to an AP-group, AP-FQLN, or AP and its neighbors discover the AirGroup servers. By default, auto-association is disabled on all AirGroup servers. An administrator can enable auto-association for each AirGroup server separately and configure AP-name, AP-group, or AP-FQLN for auto-association. Auto-association can be enabled for a complete service, which allows all the AirGroup servers who advertise that service to be auto-associated with the configured parameter. If auto-association is enabled, other location-based policy configuration for the AirGroup server on ClearPass Policy Manager or CLI is not honored. Auto-association is applicable only for wireless AirGroup servers.

By default, all AirGroup servers are visible to every AirGroup user. AirGroup allows an administrator to configure managed device-based policies for AirGroup servers to limit the visibility of AirGroup servers to destined AirGroup users. To limit the AirGroup server's visibility to intended AirGroup users, administrator can configure shared user-list, shared role-list, and shared group-list for each AirGroup server.

Administrator can also configure location-based policies for AirGroup devices. For example, administrator can configure if an AirGroup server is visible over a broader area than auto-association configuration. In location-based configuration, administrator can configure AP names, AP groups, and AP FQLNs. Location-based policy configuration limits the AirGroup server's visibility to AirGroup users who are associated to configured APs, its neighbors, AP-groups, or AP-FQLNs. Administrator can choose whether to consider the neighborhood of the configured AP names.

If an AirGroup policy is configured on ClearPass Policy Manager and CLI, the CLI configuration takes precedence over the ClearPass Policy Manager configuration. The stand-alone controller-based policy configuration is persistent for AirGroup. To configure auto association, see [Configuring AirGroup on page 954](#)

## ClearPass Policy Manager and ClearPass Guest

ClearPass Policy Manager delivers identity and device-based network access control across any wired, wireless, and VPN infrastructure. AirGroup can be deployed with ClearPass Policy Manager (recommended for large WLANs) or without ClearPass Policy Manager in smaller networks. AirGroup enables context awareness for services across the network and supports a typical customer environment with shared, local, and personal



services available to mobile devices. AirGroup and ClearPass Policy Manager work together to allow users to share personal devices.

- An AirGroup administrator uses ClearPass Policy Manager to authorize end users to register their personal devices.
- An AirGroup operator registers their personal devices (such as an Apple TV) in the ClearPass Guest portal.
- AirGroup enabled Mobility Master sends AirGroup queries to ClearPass Policy Manager for information on the registered devices and associates the access privileges of each device to its allowed services.
- ClearPass Policy Manager sends the Change of Authorization (CoA) to notify the Mobility Master about the registered devices.

To configure AirGroup-ClearPass Policy Manager interface, see [Configuring AirGroup on page 954](#)

For more information on ClearPass Policy Manager, see the *ClearPass Policy Manager User Guide* and *ClearPass Guest Deployment Guide*.

## Group-Based Device Sharing

AirGroup supports sharing AirGroup devices such as Apple TV, Printer, and so on to a **User Group** using ClearPass Policy Manager. This is an add-on to the existing device sharing mechanisms such as username, user-role, and location based device sharing using ClearPass Policy Manager. A **User Group** is a logical association of users.

A user can be a part of groups that are defined in an active directory. User group attribute for each user is identified when a user is associated to a wireless network. This is initially identified in authentication module (authentication process). Authentication module sends RADIUS request to RADIUS server as a part of 802.1X authentication and the RADIUS server fetches the user group attribute in the form of vendor specific attribute (VSA) from the Active Directory. Subsequently, AirGroup obtains this information from authentication module. This is similar to user's role, however, a user can be a part of more than one groups.

When AirGroup learns about a new device, it interacts with ClearPass Guest to obtain the shared attributes. The shared group(s) attribute is also obtained along with the following attributes:

- Device owner
- Shared location(s)
- Shared user(s)
- Shared role(s)



---

The group based device sharing feature is supported in ClearPass Policy Manager 6.3 and higher versions.

---



---

A user can be a part of maximum 32 user groups. This needs to be defined as comma separated string in Active directory. Each group name can contain a maximum of 63 characters and the entire group name strings cannot exceed 320 characters.

---

The AirGroup policy engine is enhanced to compare the user's group membership and shared groups to determine if a user can discover the specific AirGroup server or not.

## IPv6 Support

AirGroup supports IPv6 enabled users (for example, iPad) and servers (Apple TV, AirPrint printers). All the AirGroup features are available for both IPv4 and IPv6 clients. On any dual stack client, you must restart the client if the IPv4 interface is disabled.

## Bluetooth-Based Discovery and AirGroup

Apple devices support Bluetooth-based device discovery mechanism, which allows an Apple device to discover an Apple TV that is within the Bluetooth range.

AirGroup supports only mDNS-based device discovery and does not support Bluetooth-based device discovery mechanism.

## DLNA UPnP Support

AirGroup supports DLNA (Digital Living Network Alliance); a network standard that is derived from UPnP (Universal Plug and Play) in addition to the mDNS protocol.



---

Cache refresh mechanism is not required for DLNA, as the DLNA devices advertise their service periodically.

---

## Domain for 7200 Series Master Controller Mode and Stand-alone Controller

ArubaOS supports domains for 7200 Series Master Controller Mode and stand-alone controllers. This feature allows, for example, iPad users on one 7200 Series Master Controller Mode or stand-alone controller to discover an Apple TV available on another 7200 Series Master Controller Mode or stand-alone controller if both 7200 Series Master Controller Mode or stand-alone controllers are part of the same domain. All 7200 Series Master Controller Mode or stand-alone controllers in a domain communicate with each other.



---

AirGroup domain is not supported on Mobility Master or managed devices. AirGroup domain is supported only on 7200 Series Master Controller Mode or stand-alone controllers.

---

---

Configure and use up to 100 AirGroup domains where each AirGroup domain can support up to 100 IP addresses.

---

AirGroup allows one or more domains to be part of an AirGroup active-domain.

IPv6 is supported in Mobility Master-Managed Device topology but the IPv6 address of Mobility Master is not supported in AirGroup domain. The IPv4 address is supported only in the following scenarios:

- When forming an AirGroup cluster, only IPv4 addresses are supported.
- AirGroup supports IPv4 RADIUS clients only.



---

The managed device can identify any IPv6 AirGroup servers, only when they proactively advertise their services.

---

To configure domain for 7200 Series Master Controller Mode or stand-alone controller, see [Configuring AirGroup on page 954](#).

## mDNS AP VLAN Aggregation

All mDNS/SSDP packets are terminated on a Mobility Master or a stand-alone controller. The AirGroup works as a unicast querier and responder on behalf of mDNS/SSDP devices and eliminates the propagation of multicast mDNS/SSDP traffic in the WLAN.

The mDNS AP VLAN aggregation allows the discovery of wired mDNS/SSDP devices which do not have L2 connectivity with the Mobility Master or a stand-alone controller or which do not trunk on the Mobility Master or a stand-alone controller. An AP, which is in the same VLAN as the wired mDNS/SSDP device which does not trunk on Mobility Master or a stand-alone controller receives and forwards the mDNS/SSDP packets from the wired mDNS/SSDP devices to the Mobility Master or a stand-alone controller. The AP forms a separate split tunnel (0x8000) and aggregates all mDNS/SSDP traffic.

- The split tunnel is formed only when both **AP Multicast Aggregation** (under **AP System Profile**) and **AirGroup** parameters are enabled. If either **AP Multicast Aggregation** or **AirGroup** parameter is disabled, the split tunnel is not formed.
- The **AP Multicast Aggregation** parameter is disabled by default.
- When **AP Multicast Aggregation** parameter is enabled from disabled state, an mDNS/SSDP device discovery packet is sent to the VLAN in which the split tunnel is created if the **AirGroup** parameter is also enabled.
- If an AP is provisioned with an uplink VLAN, then the split tunnel between the AP and the managed device is formed with the uplink VLAN, otherwise the native VLAN is used.
- When the native VLAN is changed, the tunnel is recreated.
- Irrespective of which VLAN (uplink VLAN or native VLAN) is used, the split tunnel is in the same VLAN as the wired mDNS/SSDP devices.
- Configure the VLAN in which the wired mDNS/SSDP device terminates in the managed device. Do not create an SVI or attach a port to the VLAN.

To configure mDNS AP VLAN aggregation, see [Configuring AirGroup on page 954](#)

## mDNS Multicast Response Propagation

In the AirGroup solution, all mDNS packets are terminated on the Mobility Master. The AirGroup solution works as a unicast querier and responder on behalf of mDNS capable devices and eliminates the propagation of multicast mDNS traffic in the WLAN.

For some services, terminating the mDNS packets at the Mobility Master does not allow the initial advertisement to reach other devices. For example, the iChat or Messages Application uses mDNS response packet to announce the arrival of a new user. The new user entry does not reach the existing users if the announcement or response packet is not multicast. The existing users get to know about the new user only after they send a periodic query.

mDNS multicast response propagation allows services to multicast the response packet. This allows the existing users to instantly see a new user when a new user logs in.

The mDNS response packet for iChat or Messages Application is multicast across all VLANs that are trunked in the Mobility Master except:

- If the VLAN is globally disallowed.
- If the iChat service is disallowed for a VLAN.

In both scenarios, the mDNS response message is not propagated and:

- mDNS queries for iChat records from a disallowed VLAN are dropped.
- mDNS responses are not propagated to a disallowed VLAN.
- When an allowed VLAN is disallowed, users disappear from the buddy list of other users when they query for the service next time. This may take a maximum of one hour.
- When a disallowed VLAN is allowed, wildcard queries are sent to all users for discovery.

The AirGroup cache is updated with iChat records thus ensuring that the cache of the existing users is also updated. ClearPass Policy Manager/CLI policies are not applied to iChat records because the mDNS response is multicast. The mDNS response messages are multicast whenever the status of a user changes and similar messages are also multicast.

The response for mDNS iChat queries is L2 unicast back to the sender from the AirGroup cache while the mDNS response packets are L3 multicast.

When the iChat service is disabled from enabled state, new messages are neither propagated nor responded until they query for the service again. After an hour, the existing users disappear because query and responses are not honored. When the iChat service is enabled, discovery packets are sent to determine all iChat users.



---

The performance of an iChat server is not the same as the performance of an AirGroup server. The number of iChat servers supported is less than the number of AirGroup servers supported.

---

## mDNS Static Records

AirGroup processes mDNS packets advertised by servers. When a query arrives from a user, AirGroup responds with the appropriate cache entries and the relevant policies. AirGroup allows an administrator to create mDNS static records as group or individual records and add them to cache, when a server is:

- not mDNS compliant.
- connected to a VLAN that is not trunked to the AirGroup supported managed device.

The administrator can add these records manually to the cache using CLI commands for the servers that adhere to the above conditions.

Remember the following points when you create mDNS static records and add them to the cache:

- The mDNS static records do not expire as there is no cache refresh for static records. These static records can be deleted by an administrator.
- The Administrator needs to ensure that the relevant records are updated manually, when the IP address of a server is changed.
- The **Disallow role** policy configured on the CLI is accepted for static records. The **Disable service** policy is accepted while responding to a query. Administrator has the privilege to configure static records of a disabled service. **Disallow vlan** is not applicable for static records.
- ClearPass Policy Manager policies work with static servers.

To configure mDNS static records, see [Configuring AirGroup on page 954](#)

## Scalability

AirGroup can scale to support up to 100,000 devices in which up to 17,000 servers can exist.

### Scalability Limit in Stand-alone Controller

[Table 223](#) lists the total number of AirGroup servers and users supported by different stand-alone controller models:

**Table 223:** *AirGroup Server and User Limits in Stand-alone Controller*

Stand-alone Controller Model	Number of AirGroup Servers	Number of AirGroup Users
7240	10000	20000
7220	7000	15000
7210	5000	10000
7205	2000	6000

Stand-alone Controller Model	Number of AirGroup Servers	Number of AirGroup Users
7030	1000	3000
7024	600	1400
7010	500	1500
7005	300	700



In stand-alone deployment, there is a scaling limit of 2,000 AirGroup servers and 16,000 AirGroup users for all stand-alone controllers. If you require more servers and users than the prescribed limit, configure multiple stand-alone controllers.

The scalability limits are based on:

- [Memory Utilization](#)
- [CPU Utilization](#)

### Memory Utilization

The memory utilization is affected by the number of AirGroup servers and users in an AirGroup cluster. In an AirGroup cluster, the total number of AirGroup servers and users cannot exceed the limit defined by the top-end stand-alone controller. For example, in an AirGroup cluster of one 7005 stand-alone controller and two 7210 stand-alone controllers, the cluster limit is determined as per the scaling limit of the top-end stand-alone controller which is the 7210 stand-alone controller. For the 7005 stand-alone controller in the cluster, the platform limit of the 7005 stand-alone controller is applied.

### CPU Utilization

The CPU utilization is measured by the rate at which a stand-alone controller receives mDNS packets. The rate of mDNS packets in the cluster depends on the number of AirGroup servers, users, and number of applications installed on these devices. The rate of mDNS packets handled by the supported stand-alone controller varies. [Table 224](#) displays the total number of mDNS packets received per second by supported the stand-alone controller:

**Table 224:** *mDNS Packet Limits in Stand-alone Controller*

Stand-alone Controller Model	mDNS packets per second (pps)
7240	150
7220	90
7210	90
7205	60

Stand-alone Controller Model	mDNS packets per second (pps)
7030	75
7024	75
7010	45
7005	45

Use the following command to determine the number of mDNS packets received per second by a managed device:

```
show airgroup internal-state statistics
```




---

Issue this command multiple times to measure the time difference and the mDNS packet count.

---

### Maximum Number of iChat Users

The maximum number of iChat users is limited to 2000. Each iChat user is an mDNS server and their announcement messages are L2 multicast.

In an AirGroup domain with multiple stand-alone controllers:

- A stand-alone controller sends the response from an mDNS device for iChat service to other stand-alone controllers in the domain. This is in addition to a stand-alone controller performing L2 multicast of the message to all VLANs.
- The corresponding stand-alone controller multicasts the message to all the VLANs that are trunked in it.
- When a user moves from one stand-alone controller to another, two user entries exist in the user cache for the same user until the user entry is deleted from the first stand-alone controller. The two user entries exist because the IP address, which is part of the mDNS payload, changes when a user moves from one stand-alone controller to another. If IP mobility is enabled, only one user entry exists because the user retains the same IP address in the domain.

## Prerequisites to Enable AirGroup

Before enabling AirGroup, complete the following prerequisites:

- [Enable OpenFlow on page 950](#)
- [Bind User VLANs on page 951](#)
- [Enable OpenFlow in User Role and Virtual AP on page 952](#)
- [Configure Management Server Profile on page 952](#)
- [Enable Deep Packet Inspection on page 953](#)
- [Enable Firewall Visibility on page 953](#)




---

Complete these prerequisites only on the Mobility Master-Managed Device deployment model. Skip these prerequisites on 7200 Series Master Controller Mode deployment model.

---

### Enable OpenFlow

Enable OpenFlow on Mobility Master and managed devices. Enable OpenFlow on the **/mm** node hierarchy.

## In the WebUI

The following procedure configures OpenFlow on the Mobility Master using the WebUI:

1. In the **Mobility Master** node hierarchy, navigate to **Configuration > System > Profiles**.
2. In **All Profiles**, expand **Controller Profile**.
3. Select **openflow-controller**.
4. In **openflow-controller**, select the **ofc-state** check box.
5. Click **Save**.
6. Click **Pending Changes**.
7. In the **Pending Changes** window, select the required check box and click **Deploy changes**.

## In the CLI

The following commands configure OpenFlow on the Mobility Master using the CLI:

```
(host) [mynode] #cd /mm
(host) [mm] #configure terminal
(host) [mm] (config) #openflow-controller
(host) [mm] (openflow-controller) #openflow-controller-enable
(host) [mm] (openflow-controller) #write memory
```

## Bind User VLANs

Bind the user VLANs to the OpenFlow profile on the managed devices. Bind the user VLANs on the **/md** node hierarchy.

## In the WebUI

The following procedure binds the user VLANs to the OpenFlow profile on the managed devices using the WebUI:

1. In the **Managed Network** hierarchy, navigate to **Configuration > System > Profiles**.
2. In **All Profiles**, expand **Controller Profile**.
3. Select **Openflow-profile**.
4. In **Openflow-profile**, select the **State** check box.
5. In **controller-ip**, enter the IP address and port number of the Mobility Master.
6. In **bind-vlan**, enter the OpenFlow VLAN to the current list.
7. Click **Save**.
8. Click **Pending Changes**.
9. In the **Pending Changes** window, select the required check box and click **Deploy changes**.

## In the CLI

The following commands bind the user VLANs to the OpenFlow profile on the managed devices using the CLI:

```
(host) [mynode] #cd /md
(host) [md] #configure terminal
(host) [md] (config) #openflow-profile
(host) [md] (Openflow-profile) #openflow-enable
(host) [md] (Openflow-profile) #controller-ip <MM-ip> <port>
(host) [md] (Openflow-profile) #bind-vlan <list of user vlans>
(host) [md] (Openflow-profile) #write memory
```

## Enable OpenFlow in User Role and Virtual AP

Enable OpenFlow in the user-role and the virtual AP profile. Enable OpenFlow in the user-role and virtual AP in the **/md** node hierarchy.

### In the WebUI

The following procedure enables OpenFlow in the user-role and virtual AP on the managed devices using the WebUI:

1. In the **Managed Network** node hierarchy, navigate to **Configuration > Roles & Policies**.
2. In the **Roles** tab, select an existing role.
3. In the **Roles > <custom-role>** section, click **Show Advanced View**.
4. Under **More**, expand **Network**.
5. In the **Open flow** drop-down list, select **Enabled**.
6. Click **Submit**.
7. In the **Managed Network** node hierarchy, navigate to **Configuration > System > Profiles**.
8. In **All Profiles**, expand **Wireless LAN > Virtual AP**.
9. Select **default** profile.



---

This example uses the default profile.

---

10. In the default Virtual AP profile, expand **Advanced**.
11. Select the **Openflow Enable** check box.
12. Click **Save**.
13. Click **Pending Changes**.
14. In the **Pending Changes** window, select the required check box and click **Deploy changes**.

### In the CLI

The following commands enable OpenFlow in the user-role and virtual AP on the managed devices using the CLI:

```
(host) [mynode] #cd /md
(host) [mynode] #configure terminal
(host) [md] (config) #user-role <user-role>
(host) [md] (config-submode) #openflow-enable
(host) [md] (config-submode) #!
(host) [md] (config) #wlan virtual-ap <virtual-ap>
(host) [md] (Virtual AP profile "<virtual-ap>") #openflow-enable
(host) [md] (Virtual AP profile "<virtual-ap>") #write memory
```

## Configure Management Server Profile

Configure the management server profile to send AMON feeds to the Mobility Master for various statistics. Configure the management server profile in the **/mm** node hierarchy.

### In the WebUI

The following procedure configures management server profile on the Mobility Master using the WebUI:

1. In the **Mobility Master** node hierarchy, navigate to **Configuration > System > Profiles**.
2. In **All Profiles**, expand **Controller Profile**.
3. Select **Mgmt Config**.
4. In **Mgmt Config profile**, click the **+** icon.



5. In the **Profile name** field, enter the name of the management server profile.
6. Select the **AirGroup Info** check box.
7. Click **Save**.
8. In the **Mobility Master** node hierarchy, navigate to **Configuration > System > General**.
9. In **MON Receivers**, click the + icon.
10. In **New MON Receivers**, enter the following details:
  - a. In the **Server** field, enter the IP address of the Mobility Master
  - b. In the **Profile list** drop-down list, select the newly created management server profile.
11. Click **Submit**.
12. Click **Pending Changes**.
13. In the **Pending Changes** window, select the required check box and click **Deploy changes**.

### In the CLI

The following commands configure management server profile on the Mobility Master using the CLI:

```
(host) [mynode] #cd /mm
(host) [mm] #configure terminal
(host) [mm] (config) #mgmt-server profile <profile-name>
(host) [mm] (Mgmt Config profile "<profile-name>") #airgroup-info enable
(host) [mm] (Mgmt Config profile "<profile-name>") #!
(host) [mm] (config) #mgmt-server primary-server <MM-IP> profile <profile-name>
(host) [mm] (config) #write memory
```

## Enable Deep Packet Inspection

Enable Deep Packet Inspection (DPI) on the managed devices. Enable DPI on the **/md** node hierarchy.

### In the WebUI

The following procedure enables DPI on the managed devices using the WebUI:

1. In the **Managed Network** node hierarchy, navigate to **Configuration > Services > Firewall**.
2. Expand **Global Settings**.
3. In the **Enable deep packet inspection** drop-down list, select **Enabled**.
4. Click **Submit**.
5. Click **Pending Changes**.
6. In the **Pending Changes** window, select the required check box and click **Deploy changes**.

### In the CLI

The following commands enable DPI on the managed devices using the CLI:

```
(host) [mynode] #cd /md
(host) [md] #configure terminal
(host) [md] (config) #firewall
(host) [md] (config-submode) #dpi
(host) [md] (config) #write memory
```

## Enable Firewall Visibility

Enable firewall visibility on the managed devices to view the traffic analysis on the Mobility Master dashboard. This is an optional configuration. Enable firewall visibility on the **/md** node hierarchy.

## In the WebUI

The following procedure enables firewall visibility on the managed devices using the WebUI:

1. In the **Managed Network** node hierarchy, navigate to **Configuration > Services > Firewall**.
2. Expand **Global Settings**.
3. In the **Enable firewall visibility** drop-down list, select **Enabled**.
4. Click **Submit**.
5. Click **Pending Changes**.
6. In the **Pending Changes** window, select the required check box and click **Deploy changes**.

## In the CLI

The following command enables firewall visibility on the managed devices using the CLI:

```
(host) [mynode] #cd /md
(host) [md] #configure terminal
(host) [md] (config) #firewall-visibility
(host) [md] (config) #write memory
```

## Configuring AirGroup

AirGroup features are integrated with the WLAN Mobility Master, Managed Device, and Stand-alone Controllers. The Mobility Master also supports optional integration with ClearPass Policy Manager. Trunk all VLANs with wired devices (like printers) on the managed devices.



---

If your deployment requires ClearPass Policy Manager integration, complete the procedures described in *ClearPass Policy Manager User Guide* and *ClearPass Guest Deployment Guide* before performing the steps described in this section.

---

Use the following links to configure AirGroup:

- [Configuring AirGroup in 7200 Series Master Controller mode and Mobility Master-Managed Device model on page 954](#)
- [Configuring AirGroup in Stand-alone Controller Model on page 981](#)

### Configuring AirGroup in 7200 Series Master Controller mode and Mobility Master-Managed Device model

Use the following links to configure AirGroup in 7200 Series Master Controller mode and Mobility Master-Managed Device model:

- [Configuring Global AirGroup Parameters on page 956](#)
- [Viewing Status of Global AirGroup Parameters on page 956](#)
- [Defining Service on page 956](#)
- [Configuring Service-Based Policy on page 957](#)
- [Enabling Service on page 958](#)
- [Disabling Service on page 959](#)
- [Enabling Allowall Service on page 959](#)
- [Deleting Service on page 959](#)
- [Viewing List of Services on page 960](#)
- [Viewing List of Blocked Services on page 961](#)
- [Configuring Server-Based Policy on page 961](#)
- [Configuring Number of Hops on page 963](#)

- [Configuring Auto Association on page 963](#)
- [Viewing List of Servers on page 963](#)
- [Configuring AirGroup-ClearPass Policy Manager Interface on page 964](#)
- [Defining ClearPass Policy Manager Server on page 966](#)
- [Configuring ClearPass Policy Manager Server Options on page 966](#)
- [Assigning ClearPass Policy Manager Server to ClearPass Policy Manager Server Group on page 968](#)
- [Viewing ClearPass Policy Manager Configuration on page 968](#)
- [Defining ClearPass Policy Manager Server Group on page 969](#)
- [Defining RFC 3576 Server on page 969](#)
- [Assigning ClearPass Policy Manager Server or RFC 3576 Server to AirGroup on page 970](#)
- [Viewing ClearPass Policy Manager Device Registration on page 971](#)
- [Configuring per-VLAN AirGroup Control on page 971](#)
- [Deleting per-VLAN AirGroup Control on page 974](#)
- [Viewing VLAN Table on page 974](#)
- [Configuring mDNS AP VLAN Aggregation on page 974](#)
- [Enabling mDNS AP VLAN Aggregation on page 975](#)
- [Disabling mDNS AP VLAN aggregation on page 975](#)
- [Creating mDNS Static Records on page 976](#)
- [Configuring Domain in 7200 Series Master Controller Mode on page 977](#)
- [Deleting Domain in 7200 Series Master Controller Mode on page 977](#)
- [Viewing Domain in 7200 Series Master Controller Mode on page 978](#)
- [Configuring AirGroup Active-Domain in 7200 Series Master Controller Mode on page 979](#)
- [Removing AirGroup Active-Domain in 7200 Series Master Controller Mode on page 979](#)
- [Deleting AirGroup Active-Domain in 7200 Series Master Controller Mode on page 980](#)
- [Viewing AirGroup Active-Domain in 7200 Series Master Controller Mode on page 980](#)

Configuring AirGroup in 7200 Series Master Controller mode and Mobility Master-Managed Device model is the same except:

- In 7200 Series Master Controller mode, AirGroup configuration is possible on the managed device node hierarchy and at the device. In Mobility Master-Managed Device model, AirGroup configuration is possible only on the Mobility Master node hierarchy.
- In 7200 Series Master Controller mode, AirGroup policy configuration is possible only at the device. In Mobility Master-Managed Device model, AirGroup policy configuration is possible only on the Mobility Master node hierarchy.
- In 7200 Series Master Controller mode, domain is supported. In Mobility Master-Managed Device model, domain is not supported.
- In the 7200 Series Master Controller mode, centralized visibility is not available. In Mobility Master-Managed Device model, centralized visibility is available.

---

To configure AirGroup parameters in the 7200 Series Master Controller mode by using the WebUI or the CLI, choose Managed Device in the node hierarchy.

---




---

To configure AirGroup parameters in the Mobility Master-Managed Device model by using the WebUI or the CLI, choose Mobility Master in the node hierarchy.

---

## Configuring Global AirGroup Parameters

Configure the global AirGroup parameters by using the WebUI or the CLI.

### In the WebUI

To configure the global AirGroup parameters by using the WebUI:

1. On the **Mobility Master** node hierarchy, navigate to **Configuration > Services > AirGroup**.
2. Click **General**.
3. In the **MDNS** drop-down, select **Enabled**.
4. In the **DLNA** drop-down, select **Enabled**.
5. In the **IPv6** drop-down, select, **Enabled**.
6. Click **Submit**.
7. Click **Pending Changes**.
8. In the **Pending Changes** window, select the required check box and click **Deploy changes**.

### In the CLI

To configure the global AirGroup parameters by using the CLI:

```
(host) [mynode] #cd /mm
(host) [mm] #configure terminal
(host) [mm] (config) #airgroup dlna
(host) [mm] (config) #airgroup ipv6
(host) [mm] (config) #airgroup mdns
```

## Viewing Status of Global AirGroup Parameters

View the status of the following global AirGroup parameters:

- DLNA
- IPv6
- mDNS

### In the WebUI

To view the status of global AirGroup parameters by using the WebUI:

1. On the **Mobility Master** node hierarchy, navigate to **Configuration > Services > AirGroup**.
2. Click **General**.

### In the CLI

To view the status of global AirGroup parameters by using the CLI:

```
(host) [mynode] #show airgroup status
```

```
AirGroup Information
```

```
-----
```

Feature	Status
-----	-----
MDNS	Disabled
DLNA	Enabled
Enforce Registration	Disabled
IPV6	Enabled

## Defining Service

The DLNA service IDs are colon separated and the service ID should have the following format to discover DLNA server or devices with the maximum label size of 128 characters:

```
urn:domain-name:device:deviceType:ver
urn:domain-name:service:serviceType:ver
```

For example, you can use the following service ID to support DLNA media server under AirGroup:

```
urn:schemas-upnp-org:device:MediaServer:1
```

An mDNS service ID is the name of a Bonjour service offered by a Bonjour-enabled device or application. Bonjour defines mDNS service ID strings using the **<underscore>servicename<period><underscore>protocol.local** format.

Example: `_airplay._tcp.local`

The mDNS service ID string is case sensitive and must be entered as is without any modification, with the exception of the .local portion of the service ID which is optional.

When you add an existing mDNS service ID to a new service, AirGroup automatically deletes the mDNS service ID from the old service and displays a warning message. A sample warning message is as follows:

```
service id <_ssh._tcp> removed from <remotemgmt> and added to <remotelogin>
```

## Configuring Service-Based Policy

AirGroup defines the concept of configurable services. One or more DLNA or mDNS services can be configured on the Mobility Master. When you define a DLNA or an mDNS service as an AirGroup service, you can implement policies to restrict its availability to a specific role or VLAN.

### In the WebUI

To configure service-based policy by using the WebUI:

1. On the **Mobility Master** node hierarchy, navigate to **Configuration > Services > AirGroup**.
2. Click **Service-Based Policy**.
3. Click **+**.
4. Enter a name of the service-based policy against **Name**.
5. Enter a description of the service-based policy against **Description**.
6. Select **Enabled** against **Status** to enable the service-based policy.
7. To restrict VLANs, click **+** against **Disallow VLAN's** and:
  - To restrict VLANs by ID:
    - Select **ID** against **Disallowed VLAN's**.
    - Enter the VLAN ID against **VLAN ID**.
    - Select the VLAN type as **Servers** or **Users** against **Type**.
    - Click **OK**.
  - To restrict VLANs by name:
    - Select **Name** against **Disallowed VLAN's**.
    - Enter the VLAN name against **VLAN name**
    - Select the VLAN type as **Servers** or **Users** against **Type**.
    - Click **OK**.
8. To restrict roles, click **+** against **Disallow roles**. and:
  - Enter the role against **Disallowed roles**.
  - Select the disallowed role type as **Servers** or **Users** against **Type**.
  - Click **OK**.
9. To add a service ID, click **+** against **Service IDs** and:

- Enter the service ID against **Service id**.
  - Click **OK**.
10. To auto associate the service-based policy, select **AP-FQLN, AP-Group, or AP-Name** against **Auto associate**.
  11. Click **Submit**.
  12. Click **Pending Changes**.
  13. In the **Pending Changes** window, select the required check box and click **Deploy changes**.

### In the CLI

To configure service-based policy by using the CLI:

```
(host) [mynode] #cd /mm
(host) [mm] #configure terminal
(host) [mm] (config) #airgroupservice <string>
(host) [mm] (config-submode) #autoassociate
(host) [mm] (config-submode) #description
(host) [mm] (config-submode) #disallow-role <string> users
(host) [mm] (config-submode) #disallow-role <string> servers
(host) [mm] (config-submode) #disallow-vlan <string> users
(host) [mm] (config-submode) #disallow-vlan <string> servers
(host) [mm] (config-submode) #enable
(host) [mm] (config-submode) #id
```

### Sample Configuration

The following example configures the **iPhoto** service with access to the **\_dpap.\_tcp** service ID to share photos across MacBooks:

```
(host) [mynode] #cd /mm
(host) [mm] #configure terminal
(host) [mm] (config) #airgroupservice iPhoto
(host) [mm] (config-submode) #autoassociate apfqln
(host) [mm] (config-submode) #description Share Photos
(host) [mm] (config-submode) #enable
(host) [mm] (config-submode) #id _dpap._tcp
(host) [mm] (config-submode) #write memory
```

### Enabling Service

Enable a service by using the WebUI or the CLI.

#### In the WebUI

To enable a service by using the WebUI:

1. On the **Mobility Master** node hierarchy, navigate to **Configuration > Services > AirGroup**.
2. Click **Service-Based Policy**.
3. Click on the required service that is disabled.
4. Select **Enabled** against **Status**.
5. Click **Submit**.
6. Click **Pending Changes**.
7. In the **Pending Changes** window, select the required check box and click **Deploy changes**.

#### In the CLI

To enable a service by using the CLI:

```
(host) [mynode] #cd /mm
(host) [mm] #configure terminal
```

```
(host) [mm] (config) #airgroupservice <string>
(host) [mm] (config) #enable
(host) [mm] (config) #write memory
```

## Disabling Service

Disable a service by using the WebUI or the CLI.

### In the WebUI

To disable a service by using the WebUI:

1. On the **Mobility Master** node hierarchy, navigate to **Configuration > Services > AirGroup**.
2. Click **Service-Based Policy**.
3. Click on the required service that is enabled.
4. Select **Disabled** against **Status**.
5. Click **Submit**.
6. Click **Pending Changes**.
7. In the **Pending Changes** window, select the required check box and click **Deploy changes**.

### In the CLI

To disable a service by using the CLI:

```
(host) [mynode] #cd /mm
(host) [mm] #configure terminal
(host) [mm] (config) #airgroupservice <string>
(host) [mm] (config) #no enable
(host) [mm] (config) #write memory
```

## Enabling Allowall Service

The **allowall** service is a preconfigured AirGroup service that enables the Mobility Master to permit all AirGroup services by default, without requiring an administrator to configure an AirGroup service. Enable the **allowall** service by using the WebUI or the CLI.

### In the WebUI

To enable the allowall service by using the WebUI:

1. In **Mobility Master** node hierarchy, navigate to **Configuration > Services > AirGroup**.
2. In the **Service-Based Policy**, select the **allowall** service.
3. Select **Enabled** against **Status**.
4. Click **Apply**.
5. Click **Pending Changes**.
6. In the **Pending Changes** window, select the required check box and click **Deploy changes**.

### In the CLI

To enable the allowall service by using the CLI:

```
(host) [mynode] #cd /mm
(host) [mm] #configure terminal
(host) [mm] (config) #airgroupservice allowall enable
(host) [mm] (config) #write memory
```

## Deleting Service

Delete a service by using the WebUI or the CLI.

## In the WebUI

To delete a service by using the WebUI:

1. On the **Mobility Master** node hierarchy, navigate to **Configuration > Services > AirGroup**.
2. Click **Service-Based Policy**.
3. Click on the required service.
4. Click **Delete** icon against the service.
5. Click **Delete** in the confirmation window.
6. Click **Pending Changes**.
7. In the **Pending Changes** window, select the required check box and click **Deploy changes**.

## In the CLI

To delete a service by using the CLI:

```
(host) [mynode] #cd /mm
(host) [mm] #configure terminal
(host) [mm] (config) #no airgroupservice <string>
(host) [mm] (config) #write memory
```

## Viewing List of Services

View the list of services by using the WebUI or the CLI.

### In the WebUI

To view the list of services by using the WebUI:

1. On the **Mobility Master** node hierarchy, navigate to **Configuration > Services > AirGroup**.
2. Click **Service-Based Policy**.

### In the CLI

To view the list of services by using the CLI:

```
(host) [mynode] #show airgroupservice verbose
```

### Sample List of Services

The following is a sample list of services:

```
(host) [mynode] #show airgroupservice verbose

*****
Service Name      : remotemgmt
Description       : Remote management
Service Status    : Disabled

service id info
-----
service ID        #query-hits  #servers
-----
_ssh._tcp         0             0
_sftp-ssh._tcp    0             0
_ftp._tcp         0             0
_telnet._tcp      0             0
_rfb._tcp         0             0
_net-assistant._tcp 0             0

*****
Service Name      : DIAL
Description       : DIAL supported by Chromecast, FireTV, Roku etc
```



Service Status : Enabled

service id info  
-----

service ID	#query-hits	#servers
urn:dial-multiscreen-org:service:dial:1	0	1
urn:dial-multiscreen-org:device:dial:1	0	1

\*\*\*\*\*

Service Name : AmazonTV  
Description : Amazon fire tv  
Service Status : Enabled

service id info  
-----

service ID	#query-hits	#servers
_amzn-wplay._tcp	0	0

## Viewing List of Blocked Services

View the list of blocked services by using the CLI.

### In the CLI

To view the list of blocked services by using the CLI:

```
(host) [mynode] #show airgroup blocked-service-id
```

### Sample List of Blocked Services

The following is a sample list of blocked services:

```
(host) [mynode] #show airgroup blocked-service-id
```

AirGroup Blocked Service IDs

Origin	Service ID	#response-hits
fe80::6203:8ff:fe94:74a6	_sftp-ssh._tcp	82
fe80::6203:8ff:fe94:74a6	_ssh._tcp	82
10.16.124.236	_uscan._tcp	40
10.16.126.248	_keepalive._dns-sd._udp	20

Num Blocked Service-ID:4

## Configuring Server-Based Policy

Configure the server-based policy by using the WebUI or the CLI:

---

To configure server-based policy in the 7200 Series Master Controller mode by using the WebUI or the CLI, log in to the Managed Device.

---



---

To configure server-based policy in the Mobility Master-Managed Device model by using the WebUI or the CLI, choose Mobility Master in the node hierarchy.

---

### In the WebUI

To configure server-based policy by using the WebUI:

1. On the **Mobility Master** node hierarchy, navigate to **Configuration > Services > AirGroup**.
2. Click **Server-Based Policy**.
3. Click **+**.

4. Enter a MAC address against **MAC address** in the **Add New Device** window.
5. Click **Submit**.
6. Click **Pending Changes**.
7. In the **Pending Changes** window, select the required check box and click **Deploy changes**.

### In the CLI

To configure server-based policy by using the CLI:

#### Configuring Mac Address-Based Policy

```
(host) [mynode] #cd /mm
(host) [mm] #airgroup policy <mac>
```

#### Configuring Shared Group-List

```
(host) [mynode] #cd /mm
(host) [mm] #airgroup policy shared-group
```

#### Adding Shared Group-Name to Shared Group-List

```
(host) [mynode] #cd /mm
(host) [mm] #airgroup policy shared-group device-mac <mac> add
```

#### Removing Shared Group-name from Shared Group-List

```
(host) [mynode] #cd /mm
(host) [mm] #airgroup policy shared-group device-mac <mac> remove
```

#### Configuring Shared Role-List

```
(host) [mynode] #cd /mm
(host) [mm] #airgroup policy shared-role
```

#### Adding Shared Role-Name to Shared Role-List

```
(host) [mynode] #cd /mm
(host) [mm] #airgroup policy shared-role device-mac <mac> add
```

#### Removing Shared Role-Name from Shared Role-List

```
(host) [mynode] #cd /mm
(host) [mm] #airgroup policy shared-role device-mac <mac> remove
```

#### Configuring Shared User-List

```
(host) [mynode] #cd /mm
(host) [mm] #airgroup policy shared-user
```

#### Adding Shared User-Name to Shared User-List

```
(host) [mynode] #cd /mm
(host) [mm] (config) #airgroup policy shared-user device-mac <mac> add
```

#### Removing Shared User-Name from Shared User-List

```
(host) [mynode] #cd /mm
(host) [mm] #airgroup policy shared-user device-mac <mac> remove
```

#### Configuring Service-Based Auto-association

```
(host) [mynode] #cd /mm
(host) [mm] #configure terminal
(host) [mm] (config) #airgroupservice <string>
(host) [mm] (config-submode) #autoassociate
```

## Configuring Number of Hops

Configure the number of hops by using the WebUI or the CLI.



---

To configure number of hops in the 7200 Series Master Controller mode by using the WebUI or the CLI, log in to the Managed Device.

---

To configure number of hops in the Mobility Master-Managed Device model by using the WebUI or the CLI, choose Mobility Master in the node hierarchy.

---

### In the WebUI

To define the number of hops by using the WebUI:

1. On the **Mobility Master** node hierarchy, navigate to **Configuration > Services > AirGroup**.
2. Click **Server-Based Policy**.
3. Click on the required server-based policy.
4. Select the number of hops as **1, 2, or 3** against **Neighborhood hop(s)**.
5. Click **Submit**.
6. Click **Pending Changes**.
7. In the **Pending Changes** window, select the required check box and click **Deploy changes**.

### In the CLI

To define the number of hops by using the CLI:

```
(host) [mynode] #cd /mm
(host) [mm] #airgroup policy ap-neighborhood device-mac <mac> <number>
```

## Configuring Auto Association

Configure auto association by using the WebUI or the CLI.



---

To configure auto association in the 7200 Series Master Controller mode by using the WebUI or the CLI, log in to the Managed Device.

---

To configure auto association in the Mobility Master-Managed Device model by using the WebUI or the CLI, choose Mobility Master in the node hierarchy.

---

### In the WebUI

To configure auto association by using the WebUI:

1. On the **Mobility Master** node hierarchy, navigate to **Configuration > Services > AirGroup**.
2. Click **Server-Based Policy**.
3. Click on the required server-based policy.
4. Select auto association as **AP FQLN, AP Group, or AP Name** for **Auto associate**.
5. Click **Submit**.

### In the CLI

To configure auto association by using the CLI:

```
(host) [mynode] #cd /mm
(host) [mm] #airgroup policy autoassociate device mac <mac> {ap-fqln|ap-group|ap-name}
```

## Viewing List of Servers

View the list of servers by using the WebUI or the CLI.




---

To view list of servers in the 7200 Series Master Controller mode by using the WebUI or the CLI, log in to the Managed Device.

---

To view list of servers in the Mobility Master-Managed Device model by using the WebUI or the CLI, choose Mobility Master in the node hierarchy.

---

### In the WebUI

To view list of servers by using the WebUI:

1. On the **Mobility Master** node hierarchy, navigate to **Configuration > Services > AirGroup**.
2. Click **Server-Based Policy**.

### In the CLI

To view list of servers by using the CLI:

```
(host) [mynode] #show airgroup servers
```

### Sample List of Servers

The following is a sample list of servers:

```
(host) [mynode] #show airgroup servers
```

```
AirGroup Servers
```

```
-----
MAC                IP                Type  Host Name      Service      VLAN
---                --                ----  -
5c:aa:fd:52:5a:f8  10.16.124.224    DLNA  world_cricket  allowall     124
                    DLNA Media
5c:aa:fd:52:5a:fa  10.16.124.226    DLNA  world_cricket  DLNA Media   124
                    DLNA Media
f0:4d:a2:83:74:a5  10.16.126.16     DLNA  world_cricket  allowall     126
                    DLNA Media
11:11:11:11:11:11  0.0.0.0          mDNS  world_cricket  static       0
a0:02:dc:85:c2:98  10.16.124.181    DLNA  10-16-124-181 DIAL         124
```

```
Wired/Wireless  Role      Group  Username  AP-Name
-----
wireless        ipad
wireless        ipad
wireless        ipad
```

```
N/A
```

```
N/A
```

```
wireless        x86-role          arr
```

```
Num Servers: 5.
```

## Configuring AirGroup-ClearPass Policy Manager Interface

Configure the AirGroup and ClearPass Policy Manager interface so that AirGroup and ClearPass Policy Manager exchange information about the owner, visibility, and status for each device in the network.

The AirGroup solution allows the users to view all mDNS devices by default. AirGroup provides a set of policy definitions to allow or disallow one of more AirGroup servers from being visible to specific AirGroup users.

If an AirGroup server is not registered on a ClearPass Policy Manager server, by default, the server will be visible to all AirGroup users. The administrator must register an AirGroup server to allow or disallow this server from being visible to specific AirGroup users.

The ClearPass Policy Manager query interval refreshes the ClearPass Policy Manager entries at periodic intervals. The minimum value is 1 hour and the maximum value is 24 hours. The default value is 10 hours.

### In the WebUI

To configure AirGroup-ClearPass Policy Manager Interface by using the WebUI:

1. On the **Mobility Master** node hierarchy, navigate to **Configuration > Services > AirGroup**.
2. Click **ClearPass Policy Manager**.
3. Select **Enabled** against **Enforce registration**.
4. Enter a value against **CPPM query interval**.
5. Enter a value against **Dead time for down server**.
6. Enter a value against **UDP port for RFC 3576 request**.
7. Select a server group against **Server group**.
8. Click **+** against **RFC 3576 servers** and:
  - a. Enter an IP address against **IP address** in the **Add RFC 3576 Server** window.
  - b. Click **Submit**.
9. Click **Submit**.
10. Click **Pending Changes**.
11. In the **Pending Changes** window, select the required check box and click **Deploy changes**.

### In the CLI

To enforce registration by using the CLI:

```
(host) [mynode] #cd /mm
(host) [mm] #configure terminal
(host) [mm] (config) #airgroup server enforce registration
(host) [mm] (config) #write memory
```

To configure ClearPass Policy Manager query interval by using the CLI:

```
(host) [mynode] #cd /mm
(host) [mm] #configure terminal
(host) [mm] (config) #airgroup cppm-server query-interval <value>
(host) [mm] (config) #write memory
```

To configure dead time for down server by using the CLI:

```
(host) [mynode] #cd /mm
(host) [mm] #configure terminal
(host) [mm] (config) #airgroup cppm-server aaa
(host) [mm] (AirGroup AAA profile) #server-dead-time <server-dead-time>
(host) [mm] (AirGroup AAA profile) #write memory
```

To configure UDP port for RFC 3576 request by using the CLI:

```
(host) [mynode] #cd /mm
(host) [mm] #configure terminal
(host) [mm] (config) #airgroup cppm-server aaa
(host) [mm] (AirGroup AAA profile) #rfc3576_udp_port <rfc3576_udp_port>
(host) [mm] (AirGroup AAA profile) #write memory
```

To configure server group by using the CLI:

```
(host) [mynode] #cd /mm
(host) [mm] #configure terminal
(host) [mm] (config) #airgroup cppm-server aaa
(host) [mm] (AirGroup AAA profile) #server-group <server-group>
(host) [mm] (AirGroup AAA profile) #write memory
```

To configure RFC 3576 server by using the CLI:

```
(host) [mynode] #cd /mm
(host) [mm] #configure terminal
(host) [mm] (config) #airgroup cppm-server aaa
(host) [mm] (AirGroup AAA profile) #rfc-3576-server <rfc3576_server>
(host) [mm] (AirGroup AAA profile) #write memory
```

## Defining ClearPass Policy Manager Server

Define one or more ClearPass Policy Manager servers to be used by AirGroup. If multiple ClearPass Policy Manager servers are defined, AirGroup uses the first available server on this list. Define a ClearPass Policy Manager server for AirGroup by using the WebUI or the CLI.



---

Server-derived user roles or VLANs configured in this server group are not applicable to AirGroup.

---

### In the WebUI

To define a ClearPass Policy Manager and RFC 3576 server by using the WebUI:

1. On the **Mobility Master** node hierarchy, navigate to **Configuration > Authentication > Auth Servers** page.
2. Click **+** under **All Servers** and:
  - a. Enter a name against **Name** in **New Server** window.
  - b. Enter an IP address or hostname against **IP address / hostname** in **New Server** window.
  - c. Select the type as **Radius** against **Type**.
  - d. Click **Submit**.
3. Click **Pending Changes**.
4. In the **Pending Changes** window, select the required check box and click **Deploy changes**.

### In the CLI

To define a ClearPass Policy Manager server by using the CLI:

```
(host) [mynode] #cd /mm
(host) [mm] #configure terminal
(host) [mm] (config) #aaa authentication-server radius <rad_server_name>
```

### Sample Definition

```
(host) [mynode] #cd /mm
(host) [mm] # configure terminal
(host) [mm] (config) #aaa authentication-server radius emp_accounts
```

## Configuring ClearPass Policy Manager Server Options

Configure the ClearPass Policy Manager Server options by using the WebUI or the CLI.

### In the WebUI

To configure the ClearPass Policy Manager server options by using the WebUI:

1. On the **Mobility Master** node hierarchy, navigate to **Configuration > Authentication > Auth Servers** page.
2. Select the required server under **All Servers**.
3. Configure the server options under **Server Options** using the following table.
4. Click **Submit**.
5. In the **Pending Changes** window, select the required check box and click **Deploy changes**.

**Table 225:** *ClearPass Policy Manager Server Options*

Parameter	Description
Name	Name of ClearPass Policy Manager server
IP address / hostname	IP address or host name of ClearPass Policy Manager server
Auth port	Authentication port on the server. Default: 1812
Acct port	Accounting port on the server. Default: 1813
Shared key	Shared secret between ClearPass Policy Manager Server and AirGroup. The maximum length of key is 128 characters.
Retype key	Repeat shared secret between ClearPass Policy Manager Server and AirGroup. The maximum length of key is 128 characters.
Timeout	Maximum time, in seconds, that the ClearPass Policy Manager server waits before timing out a request. Default: 5
Retransmits	Maximum number of retries that ClearPass Policy Manager server sends before marking AirGroup as down. Default: 3
NAS ID	Network Access Server (NAS) identifier to use in RADIUS packets.
NAS IP	NAS IP address to send in RADIUS packets.
Enable IPv6	Enable/Disable IPv6 support on ClearPass Policy Manager server.
NAS IPv6	NAS IPv6 address to send in RADIUS packets.
Use MD5	Enable/Disable use of a MD5 hash in the cleartext password.
Mode	Enable/Disable the server.
Lowercase MAC address	Enable/Disable use of lower case MAC address.
Use IP address for calling station ID	Enable/Disable use of IP address instead of MAC address for the calling station ID.
MAC address delimiter	Type (colon, dash, OUI-NIC, none) of MAC address delimiter
Service-type of FRAMED-USER:	Enable/Disable service-type of framed-user.

## In the CLI

To configure the ClearPass Policy Manager server options by using the CLI:

```
(host) [mynode] #cd /mm
(host) [mm] # configure terminal
(host) [mm] (config) #aaa authentication-server radius <rad_server_name>
```

## Sample Configuration

```
(host) [mynode] #cd /mm
(host) [mm] # configure terminal
(host) [mm] (config) #aaa authentication-server radius emp_accounts
(host) [mm] (RADIUS Server "emp_accounts") #acctport 1813
(host) [mm] (RADIUS Server "emp_accounts") #authport 1812
(host) [mm] (RADIUS Server "emp_accounts") #called-station-id type ipaddr
(host) [mm] (RADIUS Server "emp_accounts") #cppm username admin password admins
(host) [mm] (RADIUS Server "emp_accounts") #enable
(host) [mm] (RADIUS Server "emp_accounts") #host 10.11.12.13
(host) [mm] (RADIUS Server "emp_accounts") #key admin123
(host) [mm] (RADIUS Server "emp_accounts") #mac-delimiter colon
(host) [mm] (RADIUS Server "emp_accounts") #mac-lowercase
(host) [mm] (RADIUS Server "emp_accounts") #nas-identifier 123
(host) [mm] (RADIUS Server "emp_accounts") #nas-ip 11.12.13.14
(host) [mm] (RADIUS Server "emp_accounts") #timeout 5
```

## Assigning ClearPass Policy Manager Server to ClearPass Policy Manager Server Group

Assign a ClearPass Policy Manager Server to a ClearPass Policy Manager Server Group by using the WebUI or the CLI.

### In the WebUI

To assign a ClearPass Policy Manager Server to a ClearPass Policy Manager Server Group by using the WebUI:

1. On the **Mobility Master** node hierarchy, navigate to **Configuration > Authentication > Auth Servers** page.
2. Select the required server group in **Server Groups** list.
3. Click **+** in the **Server Group > Server Group Name** list.
4. Select **Add existing server** in **New server for Server Group Name** window.
5. Select the required server name from the list.
6. Click **Submit**.
7. In the **Pending Changes** window, select the required check box and click **Deploy changes**.

### In the CLI

To assign a ClearPass Policy Manager Server to a ClearPass Policy Manager Server Group by using the CLI:

```
(host) [mynode] #cd /mm
(host) [mm] # configure terminal
(host) [mm] (config) #aaa server-group <name>
(host) [mm] (Server Group "<name>") #auth-server <name>
```

## Sample Configuration

```
(host) [mynode] #cd /mm
(host) [mm] # configure terminal
(host) [mm] (config) #aaa server-group employee
(host) (Server Group "employee") #auth-server emp_accounts
```

## Viewing ClearPass Policy Manager Configuration

View the ClearPass Policy Manager configuration in the WebUI or the CLI.



## In the WebUI

To view the ClearPass Policy Manager configuration by using the WebUI:

1. On the **Mobility Master** node hierarchy, navigate to the **Configuration > Services > AirGroup** page.
2. Click **ClearPass Policy Manager**.

## In the CLI

To view the ClearPass Policy Manager configuration by using the CLI:

```
(host) [mynode] #show airgroup cppm-server aaa
(host) [mynode] #show airgroup cppm-server query-interval
```

## Sample Configuration

```
(host) [mynode] #show airgroup cppm-server aaa
```

```
Airgroup AAA profile
```

```
-----
Parameter                                     Value      Set
-----
Server Group                                  san-dot1x
RFC 3576 server                               10.15.16.39
Configure dead time for a down Server         5
Configure UDP port to receive RFC 3576 server requests. 5999
```

```
(host) [mynode] #show airgroup cppm-server query-interval
```

```
CPPM Server Query Interval
```

```
-----
Timer Value  Unit
-----
9            hours
```

## Defining ClearPass Policy Manager Server Group

Define a ClearPass Policy Manager server group by using the WebUI or the CLI.

### In the WebUI

To define a ClearPass Policy Manager server group by using the WebUI:

1. On the **Mobility Master** node hierarchy, navigate to **Configuration > Authentication > Auth Servers** page.
2. Click **+** under **Server Groups** and:
  - a. Enter a name against **Name** in **Add Server Group** window.
  - b. Click **Submit**.
3. Click **Pending Changes**.
4. In the **Pending Changes** window, select the required check box and click **Deploy changes**.

### In the CLI

To define a ClearPass Policy Manager server group by using the CLI:

```
(host) [mynode] #cd /mm
(host) [mm] # configure terminal
(host) [mm] (config) #aaa server-group <name>
(host) [mm] (Server Group "<name>") #write memory
```

## Defining RFC 3576 Server

Define an RFC 3576 server by using the WebUI or the CLI.

## In the WebUI

To define an RFC 3576 server by using the WebUI:

1. On the **Mobility Master** node hierarchy, navigate to **Configuration > Authentication > Auth Servers** page.
2. Click + under **All Servers** and:
  - a. Select the type as RFC against **Type** in **New Server** window.
  - b. Enter an IP address against **IP address** in **New Server** window.
  - c. Click **Submit**.
3. Click **Pending Changes**.
4. In the **Pending Changes** window, select the required check box and click Deploy changes

## In the CLI

To define an RFC 3576 server by using the CLI:

```
(host) [mynode] #cd /mm
(host) [mm] # configure terminal
(host) [mm] (config) #aaa rfc-3576-server <server_ip>
```

## Sample Definition

```
(host) [mynode] #cd /mm
(host) [mm] # configure terminal
(host) [mm] (config) #aaa rfc-3576-server 10.11.12.14
```

## Assigning ClearPass Policy Manager Server or RFC 3576 Server to AirGroup

Assign a ClearPass Policy Manager server or an RFC 3576 server to AirGroup by using the WebUI or the CLI:



---

An AirGroup RFC 3576 server cannot use the same port as an authentication module RFC 3576 server. To avoid conflicts, use a non-standard port for the AirGroup RFC 3576 server.

---

## In the WebUI

To assign a ClearPass Policy Manager server or an RFC 3576 server to AirGroup by using the WebUI:

1. On the **Mobility Master** node hierarchy, navigate to **Configuration > Advanced Services > All Profiles**.
2. Expand the **Other Profiles** menu and select **AirGroup AAA Profile**.
3. In the **Configure dead time for a down Server** text box in the **Profile Details** window, enter a maximum period in minutes, so that a client that does not send user traffic for the given period is considered idle.
4. Enter the UDP port number in the **Configure UDP port to receive RFC 3576 server requests** field. If your network uses an RFC 3576 server for authentication, select a different port for the AirGroup 3576 server. The default in ClearPass Guest is 5999.



---

The user-defined UDP port number for RFC3576 server is automatically permitted by the firewall. The administrator does not have to explicitly define a firewall policy to permit this port.

---

5. Identify the AirGroup ClearPass Policy Manager server group. In the **Profiles** list, select the **Server Group** under the **AirGroup AAA Profile** menu.
6. In the **Profile Details** window, click the **Server Group** drop-down list to select the desired ClearPass Policy Manager server group.
7. Click **Apply**.

8. Identify the RFC 3576 server. In the **Profiles** list, select **RFC 3576 Server** under the **AirGroup AAA Profile** menu.
9. Enter the IP address of the RFC 3576 server in the **Add a profile** text box.
10. Click **Add** and **Apply**.

### In the CLI

To assign a ClearPass Policy Manager server or an RFC 3576 server to AirGroup by using the CLI:

```
(host) [mynode] #cd /mm
(host) [mm] #configure terminal
(host) [mm] (config) #airgroup cppm-server aaa
(host) (Airgroup AAA profile) #rfc-3576-server <ip-address>
(host) (Airgroup AAA profile) #rfc-3576_udp_port <port number>
(host) (Airgroup AAA profile) #server-dead-time <time>
(host) (Airgroup AAA profile) #server-group <server group name>
```



---

If your network uses an RFC 3576 server for authentication, select a different port for the AirGroup 3576 server. The default port in ClearPass Guest is 5999.

---

### Sample Configuration

```
(host) [mynode] #cd /mm
(host) [mm] #configure terminal
(host) [mm] (config) #airgroup cppm-server aaa
(host) (Airgroup AAA profile) #rfc-3576-server 10.15.16.25
(host) (Airgroup AAA profile) #rfc3576_udp_port 21334
(host) (Airgroup AAA profile) #server-dead-time 10
(host) (Airgroup AAA profile) #server-group employee
```

### Viewing ClearPass Policy Manager Device Registration

To view ClearPass Policy Manager device registration by using the CLI:

```
(host) [mynode] #show airgroup cppm entries
```

### Configuring per-VLAN AirGroup Control

Configure per-VLAN AirGroup control by using the WebUI or the CLI.

#### In the WebUI

To configure per-VLAN AirGroup control by using the WebUI:

1. On the **Mobility Master** node hierarchy, navigate to **Configuration > Services > AirGroup**.
2. Click **Per-VLAN AirGroup Control**.
3. Click **+** and:
  - To restrict VLANs by ID:
    - Select **ID** against **Disallowed VLAN's**.
    - Enter the VLAN ID against **VLAN ID**.
    - Select the VLAN type as **Servers** or **Users** against **Type**.
    - Click **OK**.
  - To restrict VLANs by name:
    - Select **Name** against **Disallowed VLAN's**.
    - Enter the VLAN name against **VLAN name**
    - Select the VLAN type as **Servers** or **Users** against **Type**.
    - Click **OK**.

4. Click **Pending Changes**.
5. In the **Pending Changes** window, select the required check box and click **Deploy changes**.

## In the CLI

To configure per-VLAN AirGroup control by using the CLI:

### Configure Named VLAN

To configure a named VLAN:

```
(host) [mynode] #cd /mm
(host) [mm] # configure terminal
(host) [mm] (config) #vlan-name <name> assignment {hash|even}
```

### Assign VLAN ID to Named VLAN

To assign a VLAN ID to a named VLAN:

```
(host) [mynode] #cd /mm
(host) [mm] # configure terminal
(host) [mm] (config) #vlan <name> 30,20
```

### Disallow Named VLAN

To disallow a named VLAN for servers at AirGroup service level:

```
(host) [mynode] #cd /mm
(host) [mm] # configure terminal
(host) [mm] (config) #airgroupservice <name> disallow-vlan <name> servers
```

To disallow a named VLAN for users at AirGroup service level:

```
(host) [mynode] #cd /mm
(host) [mm] # configure terminal
(host) [mm] (config) #airgroupservice <name> disallow-vlan <name> users
```

To verify the named VLAN configuration at the AirGroup service level:

```
(host) [mynode] #show airgroupservice verbose
```

To disallow a named VLAN for servers at AirGroup global level:

```
(host) [mynode] #cd /mm
(host) [mm] # configure terminal
(host) [mm] (config) #airgroup disallow-vlan <name> servers
```

To disallow named VLAN for users at AirGroup global level:

```
(host) [mynode] #cd /mm
(host) [mm] # configure terminal
(host) [mm] (config) #airgroup disallow-vlan <name> users
```

To verify the named VLAN configuration at the AirGroup global level using the CLI:

```
(host) [mynode] #show airgroup vlan
```

### Disallow VLAN ID

To disallow a VLAN ID for servers at AirGroup service level:

```
(host) [mynode] #cd /mm
(host) [mm] # configure terminal
(host) [mm] (config) #airgroupservice <name> disallow-vlan <id> servers
```

Example:

```
(host) [mm] (config) #airgroupservice airplay disallow-vlan 10 servers
```

With the above configuration, when a server connected on VLAN 10 advertises AirPlay service, the mDNS process does not cache the records for AirPlay service. With the above configuration, when a server connected

on VLAN 10 advertises any service other than AirPlay, the mDNS process caches the records. When a user belonging to VLAN 10 begins to advertise AirPlay service, the mDNS process does not cache the records for AirPlay service and continues to exist in the user table.

When a user belonging to vlan 10 begins to advertise any service other than airplay service, mDNS process will cache the records for non airplay service and move the user entry from user table to server table.

To disallow a VLAN ID for users at AirGroup service level:

```
(host) [mynode] #cd /mm
(host) [mm] # configure terminal
(host) [mm] (config) #airgroupservice <name> disallow-vlan <id> users
```

Example:

```
(host) [mm] (config) #airgroupservice airplay disallow-vlan 10 users
```

With the above configuration, when a user connected on VLAN 10 queries for AirPlay service, the mDNS process does not send any response for AirPlay service even if AirPlay servers are cached. With the above configuration, if a user connected on VLAN 10 queries for AirPrint or any service other than the AirPlay service, the mDNS process sends response with the cached records related to that service. When a server belonging to VLAN 10 queries for AirPlay service, no response is sent for AirPlay queries because the user query on VLAN 10 is disallowed for AirPlay service.

To verify the configuration:

```
(host) [mynode] #show airgroupservice verbose
```

To disallow VLAN for servers at AirGroup global level:

```
(host) [mynode] #cd /mm
(host) [mm] # configure terminal
(host) [mm] (config) #airgroup disallow-vlan <id> servers
```

To disallow VLAN for users at AirGroup global level:

```
(host) [mynode] #cd /mm
(host) [mm] # configure terminal
(host) [mm] (config) #airgroup disallow-vlan <id> users
```

To verify the configuration using the CLI:

```
(host) [mynode] #show airgroup vlan
```

## Disallow Role

To disallow a role for servers:

```
(host) [mynode] #cd /mm
(host) [mm] # configure terminal
(host) [mm] (config) #airgroupservice <name> disallow-role <role_name> servers
```

With the above configuration, when a server connected with role <role\_name> advertises AirPlay service, the mDNS process does not cache the records for AirPlay service. With the above configuration, when a server connected with role <role\_name> advertises any service other than the AirPlay service, the mDNS process caches the records. When a user with role <role\_name> begins to advertise AirPlay service, the mDNS process does not cache the records for AirPlay service and exists in the user table. When a user with role <role\_name> begins to advertise any service other the AirPlay service, the mDNS process caches the records for non-AirPlay service and moves the user entry from user table to the server table.

To disallow role for users:

```
(host) [mynode] #cd /mm
(host) [mm] # configure terminal
(host) [mm] (config) #airgroupservice <name> disallow-role <role_name> users
```

With the above configuration, when a client with role <role\_name> queries for AirPlay service, the mDNS process does not send any response for AirPlay service even if AirPlay servers are cached. With the above configuration, if a client connected with role <role\_name> queries for AirPrint service or any service other than the AirPlay service, the mDNS process sends response with the cached records related to that service. When a server belonging to role <role\_name> queries for AirPlay service, response is not sent for AirPlay queries because the user query from role <role\_name> is disallowed for AirPlay service.

To verify the configuration:

```
(host) [mm] #show airgroupservice verbose
```

## Deleting per-VLAN AirGroup Control

Delete per-VLAN AirGroup control by using the WebUI.

### In the WebUI

To delete per-VLAN AirGroup control by using the WebUI:

1. On the **Mobility Master** node hierarchy, navigate to **Configuration > Services > AirGroup**.
2. Click **Per-VLAN AirGroup Control**.
3. Click on the required VLAN.
4. Click **Delete** icon against the VLAN.
5. Click **Delete** in the confirmation window.
6. Click **Pending Changes**.
7. In the **Pending Changes** window, select the required check box and click **Deploy changes**.

## Viewing VLAN Table

View the VLAN table by using the WebUI. Additionally, the VLAN table shows the disallowed AirGroup VLANs.

### In the WebUI

To view the VLAN table by using the WebUI, on the **Mobility Master** node hierarchy, navigate to **Configuration > Services > AirGroup**. The VLAN table and the list of disallowed AirGroup VLANs are displayed under the **VLAN Table** section.

## Configuring mDNS AP VLAN Aggregation

Following different network topologies are possible to configure AP multicast aggregation for allowed VLANs:

1. If AP uplink is an access port with access VLAN x, the AP performs mDNS aggregation for VLAN x. Perform following configuration:
  - Create VLAN using command `vlan x`.
  - Configure native VLAN ID in system profile as `vlan x`.
  - Enable parameter AP Multicast Aggregation in ap-system profile.
2. If AP uplink is a trunk port with native VLAN as x (that is, uplink-VLAN is not configured for AP), the AP performs mDNS aggregation for VLAN x. Perform following configuration:
  - Create VLAN using command `vlan x`.
  - Configure native VLAN ID in system profile as `vlan x`.
  - Enable parameter AP Multicast Aggregation in ap-system profile.
3. If AP uplink is a trunk port with native VLAN as x, allowed VLANs as x, y, and z, and if the uplink-VLAN is configured as VLAN y for AP, the AP performs mDNS aggregation for VLAN y. Perform following configuration:
  - Configure uplink-VLAN as VLAN y in the provisioning parameters of the AP and reboot the AP.

- Create VLAN using command `vlan y`.
- Configure native VLAN in system profile as VLAN `x`.
- Enable parameter AP Multicast Aggregation in ap-system profile.

### In the CLI

#### 1. Create VLAN for AP:

```
(host) [mynode] #cd /mm
(host) [mm] # configure terminal
(host) [mm] (config) #vlan <id>
```




---

If an AP is connected on the trunk port, then configure the native VLAN of the trunk port using this command. If uplink-VLAN is configured for the AP, then use this VLAN.

---

#### 2. Configure the native VLAN ID for AP:

```
(host) [mynode] #cd /mm
(host) [mm] # configure terminal
(host) [mm] (config) #ap system-profile <profile-name> native-vlan-id <id>
```




---

If an AP is connected on the trunk port, then configure the native VLAN of the trunk port using this command.

---

#### 3. Enable mDNS aggregation:

```
(host) [mynode] #cd /mm
(host) [mm] # configure terminal
(host) [mm] (config) #ap system-profile <profile-name> mcast-aggr
```

#### 4. Map the AP system-profile to AP name:

```
(host) [mynode] #cd /mm
(host) [mm] # configure terminal
(host) [mm] (config) #ap-name <ap-name> ap-system-profile <profile-name>
```

## Enabling mDNS AP VLAN Aggregation

Enable the mDNS AP VLAN aggregation by using the WebUI or the CLI.

### In the WebUI

To enable mDNS AP VLAN aggregation by using the WebUI:

1. On the **Mobility Master** node hierarchy, navigate to **Configuration > System > Profiles**.
2. Under **All Profiles** list, select **AP > AP system > Profile-Name**.
3. Under **AP system profile: Profile-Name > General** list, select the check box against **AP multicast aggregation**.
4. Click **Save**.
5. Click **Pending Changes**.
6. In the **Pending Changes** window, select the required check box and click **Deploy changes**.

### In the CLI

To enable mDNS AP VLAN aggregation by using the CLI:

```
(host) [mynode] #cd /mm
(host) [mm] # configure terminal
(host) [mm] (config) #ap system-profile <profile-name> mcast-aggr
```

## Disabling mDNS AP VLAN aggregation

Disable the mDNS AP VLAN aggregation by using the WebUI or the CLI.

## In the WebUI

To disable mDNS AP VLAN aggregation by using the WebUI:

1. On the **Mobility Master** node hierarchy, navigate to **Configuration > System > Profiles**.
2. Under **All Profiles** list, select **AP > AP system > Profile-Name**.
3. Under **AP system profile: Profile-Name > General** list, un-select the check box against **AP multicast aggregation**.
4. Click **Save**.
5. Click **Pending Changes**.
6. In the **Pending Changes** window, select the required check box and click **Deploy changes**.

## In the CLI

To disable mDNS AP VLAN aggregation by using the CLI:

```
(host) [mynode] #cd /mm
(host) [mm] # configure terminal
(host) [mm] (config) #ap system-profile <profile-name> no mcast-aggr
```

## Creating mDNS Static Records

Create mDNS static records independently for each record type.



---

After creating a PTR, SRV, TXT, A, and AAAA static record, you can use the **show airgroup cache entries** command to view and verify the records created. You can view only the static records in the output of the **show airgroup cache entries static** command.

---

### Creating A Record

To create an A record by using the CLI:

```
(host) [mynode] #cd /mm
(host) [mm] # configure terminal
(host) [mm] (config) #airgroup static mdns-record a <mac_addr> <host_name> <ipv4addr> [server_ipaddr]
```

### Creating AAAA Record

To create an AAAA record by using the CLI:

```
(host) [mynode] #cd /mm
(host) [mm] # configure terminal
(host) [mm] (config) #airgroup static mdns-record aaaa <mac_addr> < host_name> <ipv6addr> [server_ipaddr]
```

### Creating PTR Record

To create a PTR record by using the CLI:

```
(host) [mynode] #cd /mm
(host) [mm] # configure terminal
(host) [mm] (config) #airgroup static mdns-record ptr <mac_addr> <mdns_id> <domain_name> [server_ipaddr]
```

### Creating SRV Record

To create an SRV record by using the CLI:

```
(host) [mynode] #cd /mm
(host) [mm] # configure terminal
(host) [mm] (config) #airgroup static mdns-record srv <mac_addr> <domain_name> <port> <priority> <weight> <host_name> [ server_ipaddr]
```



## Creating TXT Record

To create a TXT record using the CLI:

```
(host) [mynode] #cd /mm
(host) [mm] # configure terminal
(host) [mm] (config) #airgroup static mdns-record txt <mac_addr> <domain_name> <text> [server_
ipaddr]
```



---

You can delete the mDNS records by appending `no` at the beginning of the command. Ensure that the `[server_ipaddr]` parameter is not added while deleting mDNS records.

---

## Configuring Domain in 7200 Series Master Controller Mode

Configure domain in 7200 Series Master Controller Mode by using WebUI or CLI.

### In the WebUI

To configure domain in 7200 Series Master Controller Mode by using the WebUI:

1. On the 7200 Series Master Controller Mode node hierarchy, navigate to **Configuration > Services > AirGroup**.
2. Click **+** under **Domains**.
3. Enter a name against **Name** in **New Domain**.
4. Enter a description against **Description** in **New Domain**.
5. Click **+** under **IP address** and:
  - a. Enter an IP address against **IP address** in **Add IP**.



---

If the 7200 Series Master Controller Mode includes redundancy, use the VRRP IP address.

---

- b. Click **OK** in **Add IP**.
6. Click **Submit**.
  7. Click **Pending Changes**.
  8. In the **Pending Changes** window, select the required check box and click **Deploy changes**.

### In the CLI

To configure domain in 7200 Series Master Controller Mode by using the CLI:

```
(host) [mynode] #cd /mm
(host) [mm] #configure terminal
(host) [mm] (config) #airgroup domain <name> description <description> ip-address <ip-address>
(host) [mm] (config) #write memory
```

### Sample Configuration

```
(host) [mynode] #cd /mm
(host) [mm] #configure terminal
(host) [mm] (config) #airgroup domain college description library ip-address 10.11.12.13
(host) [mm] (config) #write memory
```

## Deleting Domain in 7200 Series Master Controller Mode

Delete domain in 7200 Series Master Controller Mode by using WebUI or CLI.

### In the WebUI

To delete domain in 7200 Series Master Controller Mode by using the WebUI:

1. On the 7200 Series Master Controller Mode node hierarchy, navigate to **Configuration > Services > AirGroup**.
2. Click **Domains**.
3. Click on the required domain.
4. Click **Delete** icon against the domain.
5. Click **Delete** in the confirmation window.
6. Click **Pending Changes**.
7. In the **Pending Changes** window, select the required check box and click **Deploy changes**.

### In the CLI

To delete domain in 7200 Series Master Controller Mode by using the CLI:

```
(host) [mynode] #cd /mm
(host) [mm] #configure terminal
(host) [mm] (config) #no airgroup domain <name>
(host) [mm] (config) #write memory
```

### Sample Configuration

```
(host) [mynode] #cd /mm
(host) [mm] #configure terminal
(host) [mm] (config) #no airgroup domain college
(host) [mm] (config) #write memory
```

## Viewing Domain in 7200 Series Master Controller Mode

View the domain in 7200 Series Master Controller Mode by using the WebUI or the CLI.

### In the WebUI

To view the domain in 7200 Series Master Controller Mode by using the WebUI:

1. On the 7200 Series Master Controller Mode node hierarchy, navigate to **Configuration > Services > AirGroup**.
2. Click **Domains**.

### In the CLI

To view the domain in 7200 Series Master Controller Mode by using the CLI:

```
(host) [mynode] #show airgroup domain
```

### Sample Configuration

```
(host) [mynode] #show airgroup domain
```

```
AirGroup Domains
-----
Name   Description  IP-Address
----  -
test   test         10.15.52.2
                10.15.52.16
ag     10.15.52.2
                10.15.52.16

Num domains:2
```

To view the IP addresses of all 7200 Series Master Controller Mode that are part of a domain by using the CLI:

```
(host) [mynode] #show airgroup multi-controller-table
```

### Sample Configuration

```
(host) [mynode] #show airgroup multi-controller-table
```

```
AirGroup Multi-Controller-Table
-----
IP-Address
-----
10.15.52.16
Num IP-Address:1
```

## Configuring AirGroup Active-Domain in 7200 Series Master Controller Mode

Configure AirGroup active-domain in 7200 Series Master Controller Mode by using the WebUI or the CLI.

### In the WebUI

To configure AirGroup active-domain in 7200 Series Master Controller Mode by using the WebUI:

1. On the 7200 Series Master Controller Mode node hierarchy, navigate to **Configuration > Services > AirGroup**.
2. Click **+** under **Domains**.
3. Enter a name against **Name** in **New Domain**.
4. Enter a description against **Description** in **New Domain**.
5. Click **+** under **IP address** and:
  - a. Enter an IP address against **IP address** in **Add IP**.



---

If the stand-alone controller deployment includes redundancy, use the VRRP IP address. Otherwise, use the IP address of the Mobility Master.

---

- b. Click **OK** in **Add IP**.
6. Select in **Enabled** against **Active** to configure the domain as an active-domain.
  7. Click **Submit**.
  8. Click **Pending Changes**.
  9. In the **Pending Changes** window, select the required check box and click **Deploy changes**.

### In the CLI

To configure AirGroup active-domain in 7200 Series Master Controller Mode by using the CLI:

```
(host) [mynode] #cd /mm
(host) [mm] #configure terminal
(host) [mm] (config) #airgroup domain <name> description <description> ip-address <ip-address>
(host) [mm] (config) #airgroup active-domain <name>
(host) [mm] (config) #write memory
```

### Sample Configuration

```
(host) [mynode] #cd /mm
(host) [mm] #configure terminal
(host) [mm] (config) #airgroup domain library description students ip-address 10.11.12.13
(host) [mm] (config) #airgroup domain cafeteria description students ip-address 10.11.12.13
(host) [mm] (config) #airgroup active-domain library
(host) [mm] (config) #airgroup active-domain cafeteria
(host) [mm] (config) #write memory
```

## Removing AirGroup Active-Domain in 7200 Series Master Controller Mode

Remove AirGroup active-domain in 7200 Series Master Controller Mode by using the WebUI or the CLI.

### In the WebUI

To remove AirGroup active-domain in 7200 Series Master Controller Mode by using the WebUI:

1. On the 7200 Series Master Controller Mode node hierarchy, navigate to **Configuration > Services > AirGroup**.
2. Click **Domains**.
3. Click on the required active-domain.
4. Select **Disabled** against **Active**.
5. Click **Submit**.
6. Click **Pending Changes**.
7. In the **Pending Changes** window, select the required check box and click **Deploy changes**.

### In the CLI

To remove AirGroup active-domain in 7200 Series Master Controller Mode by using the CLI:

```
(host) [mynode] #cd /mm
(host) [mm] #configure terminal
(host) [mm] (config) #no airgroup active-domain <name>
(host) [mm] (config) #write memory
```

### Sample Configuration

```
(host) [mynode] #cd /mm
(host) [mm] #configure terminal
(host) [mm] (config) #no airgroup active-domain library
(host) [mm] (config) #write memory
```

## Deleting AirGroup Active-Domain in 7200 Series Master Controller Mode

Delete AirGroup active-domain in 7200 Series Master Controller Mode by using the WebUI.

### In the WebUI

To delete AirGroup active-domain in 7200 Series Master Controller Mode by using the WebUI:

1. On the 7200 Series Master Controller Mode node hierarchy, navigate to **Configuration > Services > AirGroup**.
2. Click **Domains**.
3. Click on the required active-domain.
4. Click **Delete** icon against the service.
5. Click **Delete** in the confirmation window.
6. Click **Pending Changes**.
7. In the **Pending Changes** window, select the required check box and click **Deploy changes**.

## Viewing AirGroup Active-Domain in 7200 Series Master Controller Mode

View AirGroup active-domain in 7200 Series Master Controller Mode by using the WebUI or the CLI

### In the WebUI

To view AirGroup active-domain in 7200 Series Master Controller Mode by using the WebUI:

1. On the 7200 Series Master Controller Mode node hierarchy, navigate to **Configuration > Services > AirGroup**.
2. Select the **Domain**.

### In the CLI

To view AirGroup active-domain in 7200 Series Master Controller Mode by using the CLI:

```
(host) [mynode] #show airgroup active-domains
```

## Sample Configuration

```
(host) [mynode] #show airgroup active-domains
```

```
AirGroup Active-Domains
-----
Domain Name  Status
-----  -----
ag           Included
test        Included
tmp1        Excluded
Num active-domains:3
```

## Configuring AirGroup in Stand-alone Controller Model

Use the following links to configure AirGroup in stand-alone controller model:

- [Configuring Domain in Stand-alone Controller on page 981](#)
- [Deleting Domain for Stand-alone Controller on page 982](#)
- [Viewing Domain in Stand-alone Controller on page 982](#)
- [Configuring AirGroup Active-Domain in Stand-alone Controller on page 983](#)
- [Removing AirGroup Active-Domain in Stand-alone Controller on page 984](#)
- [Deleting AirGroup Active-Domain in Stand-alone Controller on page 984](#)
- [Viewing AirGroup Active-Domain in Stand-alone Controller on page 984](#)

## Configuring Domain in Stand-alone Controller

Configure domain in stand-alone controllers by using WebUI or CLI.

### In the WebUI

To configure domain in stand-alone controller by using the WebUI:

1. On the stand-alone controller, navigate to **Configuration > Services > AirGroup**.
2. Click **+** under **Domains**.
3. Enter a name against **Name** in **New Domain**.
4. Enter a description against **Description** in **New Domain**.
5. Click **+** under **IP address** and:
  - a. Enter an IP address against **IP address** in **Add IP**.
  - b. Click **OK** in **Add IP**.
6. Click **Submit**.
7. Click **Pending Changes**.
8. In the **Pending Changes** window, select the required check box and click **Deploy changes**.



---

If the stand-alone controller deployment includes redundancy, use the VRRP IP address.

---

### In the CLI

To configure domain in stand-alone controller by using the CLI:

```
(host) [mynode] #cd /mm
(host) [mm] #configure terminal
(host) [mm] (config) #airgroup domain <name> description <description> ip-address <ip-address>
(host) [mm] (config) #write memory
```

## Sample Configuration

```
(host) [mynode] #cd /mm
(host) [mm] #configure terminal
(host) [mm] (config) #airgroup domain college description library ip-address 10.11.12.13
(host) [mm] (config) #write memory
```

## Deleting Domain for Stand-alone Controller

Delete domain in stand-alone controllers by using WebUI or CLI.

### In the WebUI

To delete domain in stand-alone controller by using the WebUI:

1. On the stand-alone controller, navigate to **Configuration > Services > AirGroup**.
2. Click **Domains**.
3. Click on the required domain.
4. Click **Delete** icon against the domain.
5. Click **Delete** in the confirmation window.
6. Click **Pending Changes**.
7. In the **Pending Changes** window, select the required check box and click **Deploy changes**.

### In the CLI

To delete domain in stand-alone controller by using the CLI:

```
(host) [mynode] #cd /mm
(host) [mm] #configure terminal
(host) [mm] (config) #no airgroup domain <name>
(host) [mm] (config) #write memory
```

## Sample Configuration

```
(host) [mynode] #cd /mm
(host) [mm] #configure terminal
(host) [mm] (config) #no airgroup domain college
(host) [mm] (config) #write memory
```

## Viewing Domain in Stand-alone Controller

View the domain in stand-alone controller by using the WebUI or the CLI.

### In the WebUI

To view the domain in stand-alone controller by using the WebUI:

1. On the stand-alone controller, navigate to **Configuration > Services > AirGroup**.
2. Click **Domains**.

### In the CLI

To view the domain in stand-alone controller by using the CLI:

```
(host) [mynode] #show airgroup domain
```

## Sample Configuration

```
(host) [mynode] #show airgroup domain
```

```
AirGroup Domains
-----
Name   Description  IP-Address
----  -

```

```
test test      10.15.52.2
               10.15.52.16
ag             10.15.52.2
               10.15.52.16
Num domains:2
```

To view the IP addresses of all stand-alone controllers that are part of a domain by using the CLI:

```
(host) [mynode] #show airgroup multi-controller-table
```

### Sample Configuration

```
(host) [mynode] #show airgroup multi-controller-table
```

```
AirGroup Multi-Controller-Table
-----
IP-Address
-----
10.15.52.16
Num IP-Address:1
```

## Configuring AirGroup Active-Domain in Stand-alone Controller

Configure AirGroup active-domain in stand-alone Controller by using the WebUI or the CLI.

### In the WebUI

To configure AirGroup active-domain in stand-alone Controller by using the WebUI:

1. On the stand-alone controller, navigate to **Configuration > Services > AirGroup**.
2. Click **+** under **Domains**.
3. Enter a name against **Name** in **New Domain**.
4. Enter a description against **Description** in **New Domain**.
5. Click **+** under **IP address** and:
  - a. Enter an IP address against **IP address** in **Add IP**.



---

If the stand-alone controller deployment includes redundancy, use the VRRP IP address. Otherwise, use the IP address of the Mobility Master.

---

- b. Click **OK** in **Add IP**.
6. Select in **Enabled** against **Active** to configure the domain as an active-domain.
  7. Click **Submit**.
  8. Click **Pending Changes**.
  9. In the **Pending Changes** window, select the required check box and click **Deploy changes**.

### In the CLI

To configure AirGroup active-domain in stand-alone Controller by using the CLI:

```
(host) [mynode] #cd /mm
(host) [mm] #configure terminal
(host) [mm] (config) #airgroup domain <name> description <description> ip-address <ip-address>
(host) [mm] (config) #airgroup active-domain <name>
(host) [mm] (config) #write memory
```

### Sample Configuration

```
(host) [mynode] #cd /mm
(host) [mm] #configure terminal
(host) [mm] (config) #airgroup domain library description students ip-address 10.11.12.13
(host) [mm] (config) #airgroup domain cafeteria description students ip-address 10.11.12.13
```

```
(host) [mm] (config) #airgroup active-domain library
(host) [mm] (config) #airgroup active-domain cafeteria
(host) [mm] (config) #write memory
```

## Removing AirGroup Active-Domain in Stand-alone Controller

Remove AirGroup active-domain in stand-alone Controller by using the WebUI or the CLI.

### In the WebUI

To remove AirGroup active-domain in stand-alone Controller by using the WebUI:

1. On the stand-alone controller, navigate to **Configuration > Services > AirGroup**.
2. Click **Domains**.
3. Click on the required active-domain.
4. Select **Disabled** against **Active**.
5. Click **Submit**.
6. Click **Pending Changes**.
7. In the **Pending Changes** window, select the required check box and click **Deploy changes**.

### In the CLI

To remove AirGroup active-domain in stand-alone controller by using the CLI:

```
(host) [mynode] #cd /mm
(host) [mm] #configure terminal
(host) [mm] (config) #no airgroup active-domain <name>
(host) [mm] (config) #write memory
```

### Sample Configuration

```
(host) [mynode] #cd /mm
(host) [mm] #configure terminal
(host) [mm] (config) #no airgroup active-domain library
(host) [mm] (config) #write memory
```

## Deleting AirGroup Active-Domain in Stand-alone Controller

Delete AirGroup active-domain in stand-alone Controller by using the WebUI.

### In the WebUI

To delete AirGroup active-domain by using the WebUI:

1. On the stand-alone controller, navigate to **Configuration > Services > AirGroup**.
2. Click **Domains**.
3. Click on the required active-domain.
4. Click **Delete** icon against the service.
5. Click **Delete** in the confirmation window.
6. Click **Pending Changes**.
7. In the **Pending Changes** window, select the required check box and click **Deploy changes**.

## Viewing AirGroup Active-Domain in Stand-alone Controller

View AirGroup active-domain in stand-alone Controller by using the WebUI or the CLI

### In the WebUI

To view AirGroup active-domain in stand-alone Controller by using the WebUI:

1. On the stand-alone controller, navigate to **Configuration > Services > AirGroup**.



## 2. Select the **Domain**.

### In the CLI

To view AirGroup active-domain in stand-alone Controller by using the CLI:

```
(host) [mynode] #show airgroup active-domains
```

### Sample Configuration

```
(host) [mynode] #show airgroup active-domains
```

```
AirGroup Active-Domains
```

```
-----  
Domain Name  Status  
-----  
ag           Included  
test         Included  
tmp1         Excluded  
Num active-domains:3
```

## Best Practices and Limitations

Consider the best practices and limitations listed in this section before deploying AirGroup. The recommendations that are not specific to a deployment model, apply to both Mobility Master-Managed Device and stand-alone controller deployment model.

- [Apple iTunes Wi-Fi Synchronization and File Sharing on page 985](#)
- [Firewall Configuration on page 985](#)
- [Recommended Ports on page 986](#)
- [AirGroup Services for Large Deployments on page 987](#)
- [General AirGroup Limitations on page 987](#)

### Apple iTunes Wi-Fi Synchronization and File Sharing

When a managed device receives mDNS response for a service, it caches such records and does not propagate to other users. But for services like iTunes Wi-Fi synchronization and File Sharing to work seamlessly, such mDNS responses must be propagated to other users on the managed device even if they do not query for it.

To ensure that applications such as iTunes Wi-Fi synchronization and File Sharing work seamlessly, ArubaOS selectively forwards these mDNS responses to AirGroup users, based on the user-name ClearPass Policy Manager policy of the AirGroup server. Hence, for a customer to use these services, it is necessary to configure user-name based ClearPass Policy Manager policies for the AirGroup devices.

### Firewall Configuration

The following firewall configuration settings are recommended:

- [Disable Inter-User Firewall Settings on page 985](#)
- [ValidUser ACL Configuration on page 986](#)
- [Allow GRE and UDP 5353 on page 986](#)

### Disable Inter-User Firewall Settings

Some firewall settings can prevent the untrusted clients from communicating with each other. When these settings are enabled, an untrusted client such as an iPad may not be able to send its image to an Apple TV on the same managed device.

Use the following commands to disable the virtual AP global firewall options and allow Bonjour services to use AirGroup.

- **no firewall deny-inter-user-bridging**
- **no firewall deny-inter-user-traffic**
- **no ipv6 firewall deny-inter-user-bridging**

### ValidUser ACL Configuration

The **ValidUser** Access Control list (ACL) must allow mDNS packets with the source IP as a link local address. Do not use a **ValidUser** ACL if the user VLAN interfaces of the AirGroup managed device are not configured with an IP address.

### Allow GRE and UDP 5353

mDNS discovery uses the predefined port UDP 5353. If there is a firewall between AirGroup and WLAN, ensure that your firewall policies allow GRE and UDP 5353. DLNA uses the predefined port UDP 1900.

### Recommended Ports

The ArubaOS role-based access controls for wireless clients use ACLs to allow or deny user traffic on specific ports. Even though mDNS discovery uses the predefined port UDP 5353, application-specific traffic for services like AirPlay may use dynamically selected port numbers. As a best practice, add or modify ACLs to allow traffic on the ports as described in [Table 226](#) and [Table 227](#).



---

AirPlay operates using dynamic ports, however, printing protocols like AirPrint use fixed ports.

---

### Ports for AirPlay Service

Enable the following ports for the AirPlay services.

**Table 226:** *Ports for AirPlay Service*

Protocol	Ports
TCP	<ul style="list-style-type: none"><li>• 5000</li><li>• 7000</li><li>• 7100</li><li>• 8612</li><li>• 49152-65535</li></ul>
UDP	<ul style="list-style-type: none"><li>• 7010</li><li>• 7011</li><li>• 8612</li><li>• 49152-65535</li></ul>

### Ports for AirPrint Service

Enable the following ports for AirPrint services.

**Table 227:** Ports for AirPrint Service

Protocol	Print Service	Port
TCP	Datastream	9100
TCP	IPP	631
TCP	HTTP	80
TCP	Scanner	9500
TCP	HTTP-ALT	8080

## AirGroup Services for Large Deployments

Large deployments with many wireless and wired users often support a large number of advertised Bonjour services, which can consume a significant amount of system resources. For large scale deployments, enable the **AirPlay** and **AirPrint** services, disable the **allowall** service, and then block all other Bonjour services.

## General AirGroup Limitations

The AirGroup feature has the following limitations:

- AirGroup is supported only in tunnel and decrypt-tunnel forwarding modes.
- If you use ClearPass Policy Manager to define AirGroup users, the shared user and role lists, and location attributes cannot exceed 1000 characters.
- The RTSP protocol does not support AirPlay on an Apple TV receiver if you enable NAT on the user VLAN interface.
- The location-based access feature only supports AP FQLNs (Fully Qualified Location Names) configured in the format **<ap name>.floor <number>.<building>.<campus>**. The AP names cannot contain periods.
- AirGroup's DLNA discovery works across VLANs, however, media streaming from Windows Media Server does not work across VLANs. This limitation is because of Digital Rights Management (DRM) support in Windows Media Server, which restricts media sharing across VLANs. Media streaming works only when both client and server are connected to the same VLAN.
- Android devices cannot discover media server while using the native music and video player applications and when they are connected across VLANs. For example, Samsung Tab 3 cannot discover the media server on Samsung Galaxy S4 while using the native music and video player applications. Android devices can discover media server when they are connected in the same VLAN. This restriction is forced by Samsung devices.
- Xbox cannot be added as an extender to the Windows clients using the Windows Media Center application with the AirGroup feature enabled. You need to disable the AirGroup feature to add Xbox as an extender.
- Wireless Clients such as iPad and iPhone running the Sonos application cannot discover Sonos music system with the AirGroup is enabled.

## Troubleshooting and Log Messages

Use the following procedure to prevent potential AirGroup errors:

1. Execute the **show airgroup internal-state statistics** command and ensure that the **Sibyte Messages Sent/Recv** counters increment over a period of time.

2. Enable mDNS logs using the **logging level debugging system process mdns** command, and capture the output of **show log system all** when the issue occurs. Review any obvious error print statements.
3. Save the output of **show airgroup cache entries** and **show airgroup cppm entries** and look for any discrepancies.

## ClearPass Guest Troubleshooting Steps

ClearPass Guest includes AirGroup-related events in the application log files. You can configure logging levels to provide debugging information.

To show debugging information in event logs:

1. In ClearPass Guest, go to **Administration > AirGroup Services** and click the **Configure AirGroup Services** command link. The **Configure AirGroup Services** form opens.
2. In the **AirGroup Logging** drop-down list, select either **Debug—log debug information** or **Trace—log all debug information**. When one of these options is selected, debugging information is provided in the events log.
3. Click **Save Configuration**.

For up-to-date information, see the *ClearPass Guest Deployment Guide*.

## ClearPass Policy Manager Troubleshooting Steps

Monitoring and reporting services in ClearPass Policy Manager provide insight into system events and performance.

To show incoming AirGroup requests from the managed device:

1. In ClearPass Policy Manager, navigate to **Monitoring > Live Monitoring > Access Tracker**. The **Access Tracker** list view opens.
2. Click an event's row to view details. The **Summary** tab of the **Request Details** view opens. Additional details may be viewed on the **Input**, **Output**, or **Alerts** tabs, or you can click **Show Logs** to view logging details.

For up-to-date information, see the *ClearPass Policy Manager User Guide*.

## Log Messages

Display AirGroup logs by issuing the following CLI commands:

- **show log all**
- **show log system all**
- **show log user all**
- **show log user-debug all**

The log debug messages for the mDNS process are not enabled by default. To enable specific logging levels, use the following CLI commands in configuration mode:

To enable high level mDNS debug messages:

```
(host)(config) #logging level debugging system process mdns
```

To enable mDNS packet processing messages:

```
(host)(config) #logging level debugging system process mdns subcat messages
```

To enable mDNS CLI configuration messages:

```
(host)(config) #logging level debugging system process mdns subcat configuration
```

To enable mDNS Auth and ClearPass Policy Manager user messages:

```
(host) (config) #logging level debugging user process mdns
```

## Show Commands

Use the following show commands to view AirGroup configuration data and statistics in the managed device:

### Viewing AirGroup Flow Table

```
show airgroup flow-table
```

### Viewing AirGroup mDNS and DLAN Cache

```
show airgroup cache entries [mdns|dlna|static]
```

### Viewing AirGroup mDNS and DLNA Statistics

```
show airgroup internal-state statistics [mdns|dlna]
```

### Viewing AirGroup VLANs

```
(host) #show airgroup vlan
```

### Viewing AirGroup Servers

Use the following command to view the AirGroup server (Apple TV, AirPrint Printer, Google ChromeCast, and so on) status in the managed device:

```
show airgroup servers [dlna|mdns] [verbose]
```

### Viewing AirGroup Users

```
show airgroup users [mdns|dlna] [verbose]
```

### Viewing Service Queries Blocked by AirGroup

This command displays the service ID that was queried but not available in the AirGroup service table.

```
show airgroup blocked-queries [mdns|dlna]
```

### Viewing Blocked Services

The `airgroup service <servicename> disable` command disables an AirGroup service by blocking the service IDs for that service. When you enable an AirGroup service, service IDs of that service are enabled automatically. To view the list of blocked services, use the following command:

```
show airgroup blocked-service-id [mdns|dlna]
```

ArubaOS is the companion controller release for the Aruba Instant release. This release provides an ability to terminate VPN and GRE tunnels from Instant AP (IAP) and provide corporate connectivity to the branch IAP network. For more details, see the *Aruba Instant User Guide*.



---

IAP VPN feature is applicable only for hardware platforms that are running ArubaOS 8.0 as a stand-alone controller.

---

VPN features are ideal for:

- enterprises with many branches that do not have a dedicated VPN connection to the Head Quarter.
- branch offices that require multiple APs.
- individuals working from home, connecting to the VPN.

This new architecture and form factor seamlessly adds the survivability feature of Instant APs with the VPN connectivity of RAPs — providing corporate connectivity to branches.

This section includes the following topics:

- [Overview on page 990](#)
- [VPN Configuration on page 994](#)
- [Viewing Branch Status on page 996](#)

## Overview

This section provides a brief summary of the new features included in ArubaOS to support VPN termination from IAP.

### Improved DHCP Pool Management

IAP allows you to configure the DHCP address assignment for the branches connected to the corporate network through VPN. In distributed DHCP mode, ArubaOS 8.0 allows designated blocks of IP addresses for static IP users by excluding them from the DHCP scope. In addition, it allows creation of scope of any required size, thereby enabling more efficient utilization of IP address across branches. For detailed information on Distributed DHCP for IAP-VPN, see *Aruba Instant User Guide*.

### Termination of Instant AP VPN Tunnels

You can configure IAPs to terminate VPN tunnels on controllers. When configured, the IAP cluster creates a tunnel from the Virtual Controller (VC) to an Aruba controller. However, the controller only acts as a VPN end-point and does not configure the IAP. For more information on how to create a VPN tunnel from a VC to an Aruba controller, see *Aruba Instant User Guide*.

### Termination of IAP GRE Tunnels

IAPs have the ability to terminate GRE tunnels on controllers. The IAP cluster creates a tunnel from the VC to the controller in your corporate office. The controller only acts as a GRE end-point and does not configure the IAP. For more information on how to create a GRE tunnel from VC to the controller, see the *Aruba Instant Guide*.

## L2/L3 Network Mode Support

The IAP functioning as a VC enables different DHCP pools (various deployment models) in addition to allocating IP subnets to each branch.

IAPs support the following DHCP configuration modes:

- **L2 Switching Mode:** In this mode, IAP supports distributed L2 and centralized L2 switching modes of connection to the corporate network. When an IAP registers with the controller and has a L2 mode DHCP pool configured, the controller automatically adds the GRE or VPN tunnel associated to this IAP into the VLAN multicast table. This allows the clients connecting to this L2 mode VLAN to be part of the same L2 domain on controller.
- **L3 Routing Mode:** In this mode, IAP supports L3 routing mode of connection to the corporate network. The VC assigns an IP addresses from the configured subnet and forwards traffic to both corporate and non-corporate destinations. The IAP handles the routing on the subnet and also adds a route on the controller after the VPN tunnel is set up during the registration of the subnet. When the IAP registers with a L3 mode DHCP pool, the controller automatically adds a route to this DHCP subnet enabling routing of traffic from the corporate network to clients on this VLAN in the branch.

## Instant AP VPN Scalability Limits

ArubaOS provides enhancements to the scalability limits for the IAP VPN branches terminating on the controller. The following table provides the IAP VPN scalability information for various controller platforms:

**Table 228:** *Instant AP VPN Scalability Limits*

Platforms	Branches	Routes	L3 Mode Users	NAT Users
7005	64	6*128	N/A	N/A
7010	128	6*256		
7024	128	6*128		
7030	256	6*512		
7205	1024	6*1024		
7210	2048	32K		
7220	4096	64K		
7240	8192	128K		

- **Branches**—The number of IAP VPN branches that can be terminated on a given controller platform.
- **Routes**—The number of L3 routes supported on the controller.
- **L3 mode and NAT mode users**—The number of trusted users supported on the controller. There is no scale impact on the controller. They are limited only by the number of clients supported per Instant AP.

## Instant AP VPN OSPF Scaling

ArubaOS allows each IAP VPN to define a separate subnet derived from a corporate intranet pool to allow IAP VPN devices to work independently. For information on sample topology and configuration, see [OSPFv2](#).

To redistribute IAP VPN routes into the OSPF process, use the following command :

```
(host) [mynode] (config) #router ospf redistribute rapng-vpn
```

To verify if the redistribution of the IAP VPN is enabled, use following command:

```
(host) [mynode] #show ip ospf redistribute
Redistribute RAPNG
```

To configure aggregate route for IAP VPN routes, use the following command:

```
(host) [mynode] (config) # router ospf aggregate-route rapng-vpn
```

To view the aggregated routes for IAP VPN routes, use the following command:

```
(host) [mynode]#show ip ospf rapng-vpn aggregate-routes
RAPNG VPN aggregate routes
```

```
-----
Prefix Mask Contributing routes Cost
-----
201.201.200.0 255.255.252.0 5 268779624
100.100.2.0 255.255.255.0 1 10
```

To verify the details of configured aggregated route, use the following command:

```
(host) [mynode]# show ip ospf rapng-vpn aggregated-routes <net> <mask>
(host) [mynode]#show ip ospf rapng-vpn aggregate-routes 100.100.2.0 255.255.255.0
Contributing routes of RAPNG VPN aggregate route
```

```
-----
Prefix Mask Next-Hop Cost
-----
100.100.2.64 255.255.255.224 5.5.0.10 10
```

To view all the redistributed routes:

```
(host) [mynode]#show ip ospf database
OSPF Database Table
```

```
-----
Area ID      LSA Type      Link ID      Adv Router    Age   Seq#          Checksum
-----
0.0.0.15    ROUTER        9.9.9.9      9.9.9.9       159  0x80000016   0xee92
0.0.0.15    ROUTER        10.15.148.12 10.15.148.12  166  0x80000016   0x4c0d
0.0.0.15    NETWORK      10.15.148.12 10.15.148.12  167  0x80000001   0x9674
0.0.0.15    NSSA         12.12.2.0    9.9.9.9       29   0x80000003   0x7b54
0.0.0.15    NSSA         12.12.12.0   9.9.9.9       164  0x80000008   0x63a
0.0.0.15    NSSA         12.12.12.32  9.9.9.9       164  0x80000008   0x7b8
0.0.0.15    NSSA         50.40.40.0   9.9.9.9       164  0x80000007   0x8ed4
0.0.0.15    NSSA         51.41.41.128 9.9.9.9       164  0x80000007   0x68f6
0.0.0.15    NSSA         53.43.43.32  9.9.9.9       164  0x80000007   0x2633
0.0.0.15    NSSA         54.44.44.16  9.9.9.9       164  0x80000007   0x353
N/A        AS_EXTERNAL  12.12.2.0    9.9.9.9       29   0x80000003   0x8c06
N/A        AS_EXTERNAL  12.12.12.0   9.9.9.9       169  0x80000001   0x25e4
N/A        AS_EXTERNAL  12.12.12.32  9.9.9.9       169  0x80000001   0x2663
N/A        AS_EXTERNAL  50.40.40.0   9.9.9.9       169  0x80000001   0xab80
N/A        AS_EXTERNAL  51.41.41.128 9.9.9.9       169  0x80000001   0x85a2
N/A        AS_EXTERNAL  53.43.43.32  9.9.9.9       169  0x80000001   0x43de
N/A        AS_EXTERNAL  54.44.44.16  9.9.9.9       169  0x80000001   0x20fe
```

To verify if the redistributed routes are installed or not.

```
(host) [mynode]#show ip route
Codes: C - connected, O - OSPF, R - RIP, S - static
M - mgmt, U - route usable, * - candidate default, V - RAPNG VPN
Gateway of last resort is Imported from DHCP to network 0.0.0.0 at cost 10
Gateway of last resort is Imported from CELL to network 0.0.0.0 at cost 10
Gateway of last resort is Imported from PPPOE to network 0.0.0.0 at cost 10
Gateway of last resort is 10.15.148.254 to network 0.0.0.0 at cost 1
S*    0.0.0.0/0 [1/0] via 10.15.148.254*
V    12.12.2.0/24 [10/0] ipsec map
V    12.12.12.0/25 [10/0] ipsec map
```



```

V 12.12.12.32/27 [10/0] ipsec map
V 50.40.40.0/24 [10/0] ipsec map
V 51.41.41.128/25 [10/0] ipsec map
V 53.43.43.32/27 [10/0] ipsec map
V 54.44.44.16/28 [10/0] ipsec map
C 9.9.9.0/24 is directly connected, VLAN9
C 10.15.148.0/24 is directly connected, VLAN1
C 43.43.43.0/24 is directly connected, VLAN132
C 42.42.42.0/24 is directly connected, VLAN123
C 44.44.44.0/24 is directly connected, VLAN125
C 182.82.82.12/32 is an ipsec map 10.15.149.69-182.82.82.12
C 182.82.82.14/32 is an ipsec map 10.17.87.126-182.82.82.14

```

## Branch-ID Allocation

For branches deployed in distributed L3 and distributed L2 modes, the master AP in the branch and the controller must agree upon a subnet and IP addresses to be used for DHCP services in the branch. The process or protocol used by the master AP and the controller to determine the subnet and IP addresses used in a branch is called BID allocation. If the branches are deployed in local-only or centralized-l2-only modes, the BID allocation process is not required.

The BID allocation process performs the following functions:

- Determines the IP addresses used in a branch for distributed L2 mode
- Determines the subnet used in a branch for distributed L3 mode
- Avoids IP address or subnet overlap (that is, avoids IP conflict)
- Ensures that a branch is allocated the same subnet or range of IP addresses irrespective of which AP in the branch assumes the role of the master in an IAP cluster

## Trusted Branch Validation

The branch registration requests sent by the IAP indicates whether the IAP is managed by AirWave or Central, and provides information about the IAP configuration modes on AirWave (managed or monitored modes). Based on the information received in the registration request and the status of trusted branch configuration, controller allows the IAP to register the branch.

[Table 229](#) maps the IAP configuration scenario to the branch registration and trusted branch validation process.

**Table 229:** *Branch Registration and Trusted Branch Validation*

IAP Configuration Mode on AirWave or Central	Trusted Branch DB Validation Enabled on Controller	Branch Registration Allowed?
Monitor mode	Yes	No
Monitor mode	No	Yes
Managed mode	Yes	Yes

**Table 229: Branch Registration and Trusted Branch Validation**

IAP Configuration Mode on AirWave or Central	Trusted Branch DB Validation Enabled on Controller	Branch Registration Allowed?
Managed mode	No	Yes
Not managed by AirWave or Central	Yes	No
Not managed by AirWave or Central	No	Yes

To enable trusted branch DB validation:

- Ensure that the IAPs are running Instant 4.0 or later.
- Ensure that the controller is upgraded to ArubaOS 8.0 or later.



---

If you have a master-local setup to be upgraded to ArubaOS 8.0, upgrade the master controller first, and then the local controller.

---

- Ensure that the IAP-VPN branches are configured through the AirWave or Central management interfaces. If the IAP VPN branches are not managed by AirWave or Central, or if your network has IAPs running Instant 3.4 or lower release versions, execute the following command to ensure that all branches are in the trusted list:

```
(host) [mynode] (config) #iap trusted-branch-db allow-all
```

or

```
(host) [mynode] (config) #iap trusted-branch-db add mac-address <mac-address>
```

## VPN Configuration

The following VPN configuration steps on the controller enable IAPs to terminate their VPN connection on the controller:

### Whitelist DB Configuration

#### Controller Whitelist DB

You can use the following CLI command to configure the whitelist DB if the controller is acting as the whitelist entry:

```
(host) [mynode] #whitelist-db rap add mac-address 00:11:22:33:44:55 ap-group test
```

The **ap-group** parameter is not used for any configuration, but needs to be configured. The parameter can be any valid string. If an external whitelist is being used, the MAC address of the AP needs to be saved in the Radius server as a lower case entry without any delimiter.

#### External Whitelist DB

The external whitelist functionality enables you to configure the RADIUS server to use an external whitelist for authentication of MAC addresses of RAPs.

If you are using Windows 2003 server, perform the following steps to configure external whitelist on it. There are equivalent steps available for Windows Server 2008 and other RADIUS servers.

1. Add the MAC addresses for all the RAPs in the Active Directory of the RADIUS server:

- a. Open the **Active Directory and Computers** window, add a new user and specify the MAC address (without the colon delimiter) of the RAP for the user name and password.
  - b. Right-click the user that you have just created and click **Properties**.
  - c. In the **Dial-in** tab, select **Allow access** in the **Remote Access Permission** section and click **OK**.
  - d. Repeat Step a through Step b for all RAPs.
2. Define the remote access policy in the Internet Authentication Service:
    - a. In the **Internet Authentication Service** window, select **Remote Access Policies**.
    - b. Launch the wizard to configure a new remote access policy.
    - c. Define filters and select **grant remote access permission** in the **Permissions** window.
    - d. Right-click the policy that you have just created and select **Properties**.
    - e. In the **Settings** tab, select the policy condition, and **Edit Profile...**
    - f. In the **Advanced** tab, select **Vendor Specific**, and click **Add** to add new vendor specific attributes.
    - g. Enter new vendor specific attributes and click **OK**.
    - h. In the **IP** tab, provide the IP address of the RAP and click **OK**.

## VPN Local Pool Configuration

The VPN local pool is used to assign an IP Address to the IAP after successful XAUTH VPN.

```
(host) [mynode] (config)# ip local pool "rapngpool" <pool_start_address> <pool_end_address>
```

## Role Assignment for the Authenticated IAPs

Define a role that includes a source NAT rule to allow connections to the RADIUS server and for the Dynamic Radius Proxy in the IAP to work. This role is assigned to IAPs after successful authentication.

```
(host) [mynode] (config) #ip access-list session iaprole
(host) [mynode] (config-submode) #any host <radius-server-ip> any src-nat
(host) [mynode] (config-submode) #any any any permit
(host) [mynode] (config-submode) #!
(host) [mynode] (config) #user-role iaprole
(host) [mynode] (config-submode) #session-acl iaprole
```

## VPN Profile Configuration

The VPN profile configuration defines the server used to authenticate the IAP (internal or an external server) and the role assigned to the IAP after successful authentication.

```
(host) [mynode] (config) #aaa authentication vpn default-iap
(host) [mynode] (VPN Authentication Profile "default-iap") #server-group default
(host) [mynode] (VPN Authentication Profile "default-iap") #default-role iaprole
```




---

The **default role** parameter of the **aaa authentication vpn** command requires **Policy Enforcement Firewall for VPN users (PEFV)** license.

---




---

By default, the controller uses the default IAP role. If the administrator changes the IAP role name when the IAP's status is UP, then the controller or the IAP must be rebooted.

---

For more information on VPN profile configuration, see the *VPN Configuration* chapter of the *Aruba Instant User Guide*.

## Viewing Branch Status

To view the details of the branch information connected to the controller, execute the **show iap table** command.

### Sample Configuration

This example shows the details of the branches connected to the controller:

```
(host) [mynode] #show iap table long
```

IAP Branch Table

```
-----  
Name                VC MAC Address      Status  Inner IP      Assigned Subnet  Assigned Vlan  
-----  
Tokyo-CB:D3:16      6c:f3:7f:cc:42:f8  DOWN   0.0.0.0  
Paris-CB:D3:16      6c:f3:7f:cc:3d:04  UP     10.15.207.140  10.15.206.99/29  2  
LA                   6c:f3:7f:cc:42:25  UP     10.15.207.111  10.15.206.24/29  2  
Munich              d8:c7:c8:cb:d3:16  DOWN   0.0.0.0  
London-c0:e1        6c:f3:7f:c0:e1:b1  UP     10.15.207.120  10.15.206.64/29  2  
Instant-CB:D3       6c:f3:7f:cc:42:1e  DOWN   0.0.0.0  
Delhi               6c:f3:7f:cc:42:ca  DOWN   0.0.0.0  
Singapore           6c:f3:7f:cc:42:cb  UP     10.15.207.122  10.15.206.120/29  2
```

```
Key                Bid(Subnet Name)  
-----  
b3c65c...  
b3c65c...  
b3c65c... 2(10.15.205.0-10.15.205.250,5),1(10.15.206.1-10.15.206.252,5)  
a2a65c... 0  
b3c65c... 7(10.15.205.0-10.15.205.250,5),8(10.15.206.1-10.15.206.252,5)  
b3c65c...  
b3c65c... 1(10.15.205.0-10.15.205.250,5),2(10.15.206.1-10.15.206.252,5)  
b3c65c... 14(10.15.205.0-10.15.205.250,5),15(10.15.206.1-10.15.206.252,5)
```

The output of this command includes the following parameters:

**Table 230:** IAP Table Parameters

Parameter	Description
Name	Displays the name of the branch.
VC MAC Address	Displays the MAC address of the Virtual Controller of the branch.
Status	Displays the current status of the branch (UP/DOWN).
Inner IP	Displays the internal VPN IP of the branch.
Assigned Subnet	Displays the subnet mask assigned to the branch.

Parameter	Description
Assigned Vlan	Displays the VLAN ID assigned to the branch.
Key	Displays the key for the branch, which is unique to each branch.
Bid(Subnet Name)	<p>Displays the Branch ID (BID) of the subnet.</p> <ul style="list-style-type: none"> <li>In the example above, the controller displays bid-per-subnet-per-branch i.e., for "LA" branch, BID "2" for the ip-range "10.15.205.0-10.15.205.250" with client count per branch "5". If a branch has multiple subnets, it can have multiple BIDs.</li> <li>Branches that are in <b>UP</b> state and do not have a <b>Bid(Subnet Name)</b> means that the IAP is connected to a controller which did not assign any bid for any subnet. In the above example, "Paris-CB:D3:16" branch is <b>UP</b> and does not have a <b>Bid(Subnet Name)</b> information. This means that either the IAP is connected to a backup controller or connected to a primary controller without any distributed L2 or L3 subnets.</li> </ul> <p>For more information on bid-per-subnet-per-branch and distributed L2 and L3 subnets, see the <i>DHCP Configuration</i> chapter of the <i>Aruba Instant Access Point 6.2.1.0-3.3 User Guide</i>.</p>




---

Executing the **show iap table** command does not display the **Key** and **Bid(Subnet Name)** parameters.

---

The External Services Interface (ESI) provides an open interface that is used to integrate security solutions that solve interior network problems such as viruses, worms, spyware, and corporate compliance. ESI allows selective redirection of traffic to external service appliances such as anti-virus gateways, content filters, and intrusion detection systems. When “interesting” traffic is detected by these external devices, it can be dropped, logged, modified, or transformed according to the rules of the device. ESI also permits configuration of different server groups—with each group potentially performing a different action on the traffic.

You can configure ESI to do one or more of the following for each group:

- Redirect specified types of traffic to the server
- Perform health checks on each of the servers in the group
- Perform per-session load balancing between the servers in each group
- Provide an interface for the server to return information about the client that can place the client in special roles such as “quarantine”



---

ESI cannot function or send information across an IPsec tunnel.

---

ESI also provides the ESI syslog parser, which is a mechanism for interpreting syslog messages from third-party appliances such as anti-virus gateways, content filters, and intrusion detection systems. The ESI syslog parser is a generic syslog parser that accepts syslog messages from external devices, processes them according to user-defined rules, and then takes configurable actions on system users.

Topics in this chapter include:

- [Sample ESI Topology on page 998](#)
- [Understanding the ESI Syslog Parser on page 1000](#)
- [Configuring ESI on page 1003](#)
- [Sample Route-Mode ESI Topology on page 1010](#)
- [Sample NAT-mode ESI Topology on page 1016](#)
- [Understanding Basic Regular Expression \(BRE\) Syntax on page 1021](#)



---

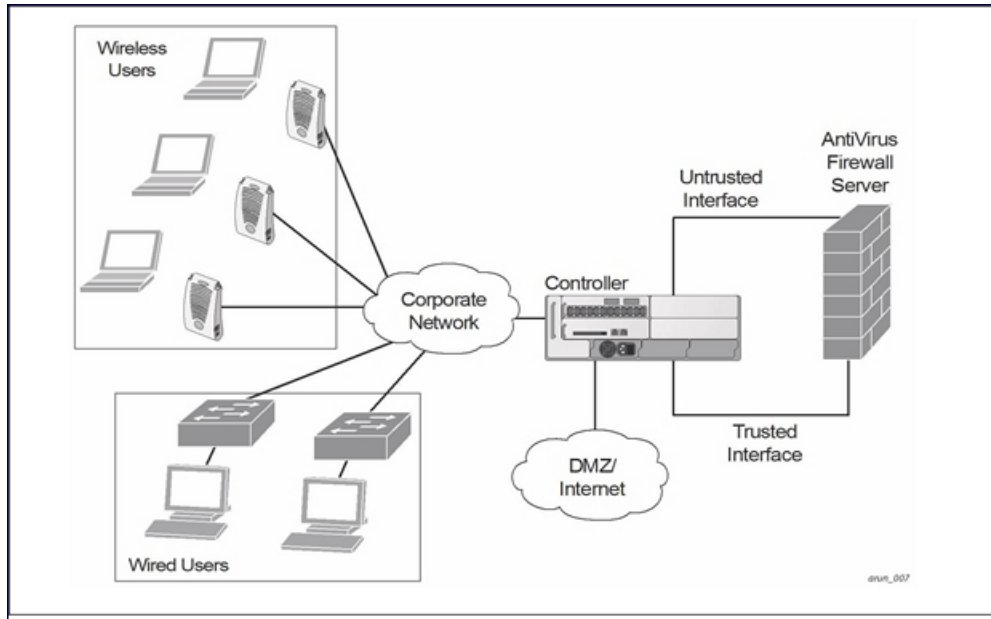
The ESI feature requires that the Policy Enforcement Firewall Next Generation (PEFNG) license is installed on the managed device.

---

## Sample ESI Topology

In the example shown in this section, ESI is used to provide an interface to the AntiVirusFirewall (AVF) server device for providing virus inspection services. An AVF server device is one of many different types of services supported in the ESI.

**Figure 118** ESI-Fortinet Topology



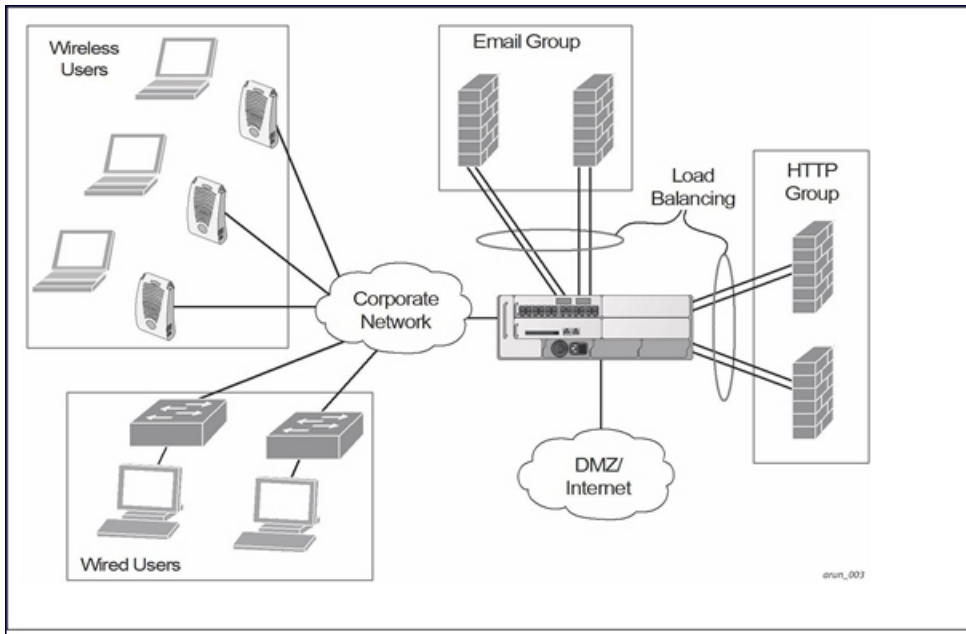
In the ESI-Fortinet topology, the clients connect to access points (both wireless and wired). The wired access points tunnel all traffic back to the managed device over the existing network.

The managed device receives the traffic and redirects relevant traffic (including but not limited to all HTTP/HTTPS and email protocols such as SMTP and POP3) to the AVF server device to provide services such as anti-virus scanning, email scanning, web content inspection, etc. This traffic is redirected on the “untrusted” interface between the managed device and the AVF server device. The managed device also redirects the traffic intended for the clients coming from either the Internet or the internal network. This traffic is redirected on the “trusted” interface between the managed device and the AVF server device. The managed device forwards all other traffic (for which the AVF server does not perform any of the required operations such as AV scanning). An example of such traffic would be database traffic running from a client to an internal server.

The managed device can also be configured to redirect traffic only from clients in a particular role such as “guest” or “non-remediated client” to the AVF server device. This might be done to reduce the load on the AVF server device if there is a different mechanism such as the Aruba-Sygate integrated solution to enforce client policies on the clients that are under the control of the IT department. These policies can be used to ensure that an anti-virus agent runs on the clients and the client can get access to the network only if this agent reports a “healthy” status for the client. Refer to the paper (available from Sygate) on Sygate integrated solutions for more details on this solution.

The managed device is also capable of load balancing between multiple external server appliances. This provides more scalability as well as redundancy by using multiple external server appliances. Also, the managed device can be configured to have multiple groups of external server devices and different kinds of traffic can be redirected to different groups of devices with load balancing occurring within each group (see [Figure 119](#) for an example).

**Figure 119** Load Balancing Groups



## Understanding the ESI Syslog Parser

The ESI syslog parser adds a UNIX-style regular expression engine for parsing relevant fields in messages from third-party appliances such as anti-virus gateways, content filters, and intrusion detection systems.

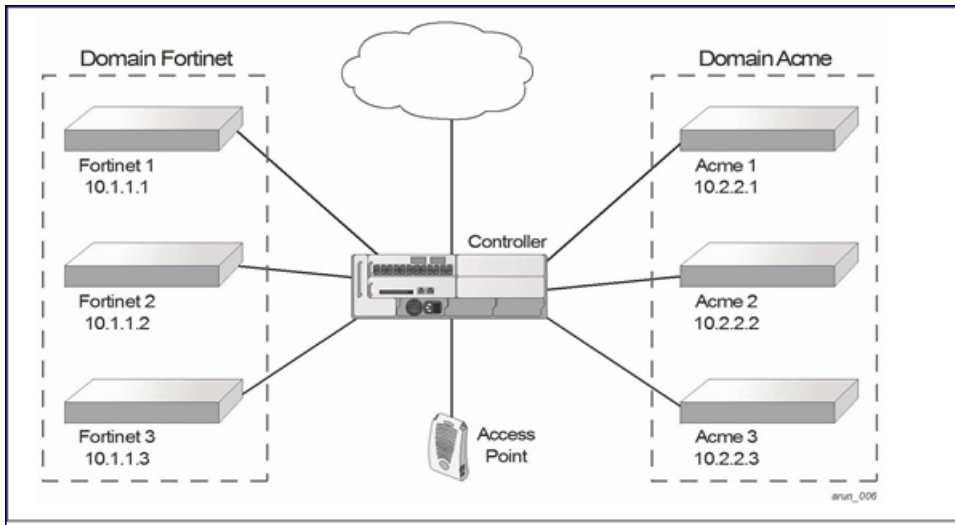
The user creates a list of rules that identify the type of message, the username to which this message pertains, and the action to be taken when there is a match on the condition.

### ESI Parser Domains

The ESI servers are configured into ESI parser domains (see [Figure 120](#)) to which the rules will be applied. This condition ensures that only messages coming from configured ESI parser domains are accepted, and reduces the number of rules that must be examined before a match is detected ([Syslog Parser Rules on page 1002](#)). messages. When a syslog message is received, it is checked against the list of defined ESI servers. If a server match is found, the message is then tested against the list of predefined rules.



**Figure 120** ESI Parser Domains



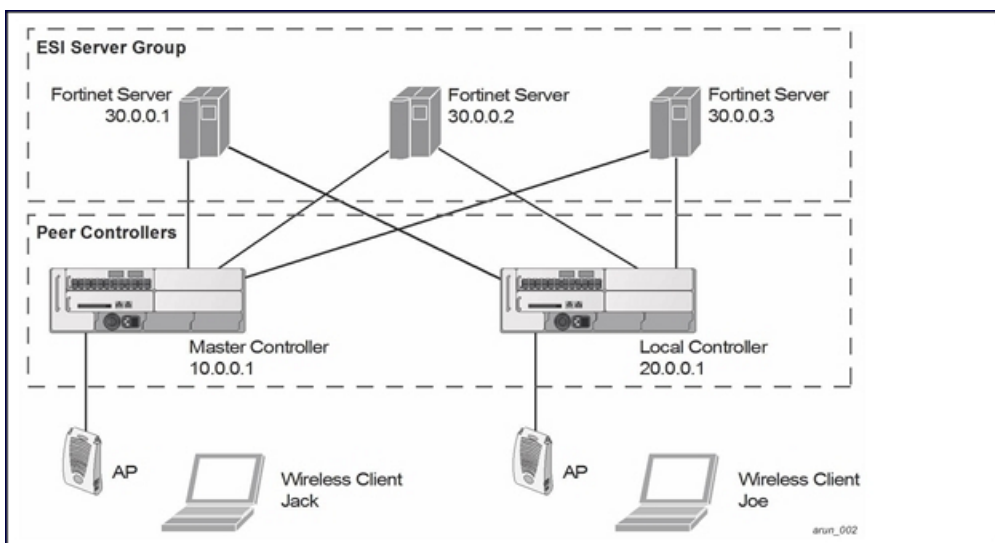
The ESI syslog parser begins with a list of configured IP interfaces which listen for ESI messages. When a syslog message is received, it is checked against the list of defined ESI servers. If a server match is found, the message is then tested against the list of predefined rules.

Within the rule-checking process, the incoming message is checked against the list of rules to search first for a condition match (see [Syslog Parser Rules on page 1002](#)). If a condition match is made, and the user name can be extracted from the syslog message, the resulting user action is processed by first attempting to look up the user in the local user table. If the user is found, the appropriate action is taken on the user. The default behavior is to look for users only on the local managed device. If the user is not found, the event is meaningless and is ignored. This is the typical situation when a single managed device is connected to a dedicated ESI server.

## Peer Managed Devices

As an alternative, consider a topology where multiple managed device share one or more ESI servers.

**Figure 121** ESI Peer managed device



In this scenario, several managed device (master and local) are defined in the same syslog parser domain to act as *peers*. From the standpoint of the ESI servers, because there is no accurate way of determining from which managed device a given user came. Thus, the event is flooded out to all managed device defined as peers within this ESI parser domain. The corresponding managed device holding the user entry acts on the event, while other managed device ignore the event.

## Syslog Parser Rules

The user creates an ESI rule by using characters and special operators to specify a pattern (regular expression) that uniquely identifies a certain amount of text within a syslog message. (Regular expression syntax is described in [Understanding Basic Regular Expression \(BRE\) Syntax on page 1021](#).) This “condition” defines the type of message and the ESI domain to which this message pertains. The rule contains three major fields:

- Condition: The pattern that uniquely identifies the syslog message type.
- User: The username identifier. It can be in the form of a name, MAC address, or IP address.
- Action: The action to take when a rule match occurs.

Once a condition match has been made, no further rule-matching will be made. For the rule that matched, only one action can be defined.

After a condition match has been made, the message is parsed for the user information. This is done by specifying the target region with the regular expression (REGEX) `regex()` block syntax. This syntax generates two blocks: The first block is the matched expression; the second block contains the value inside the parentheses. For username matching, the focus is on the second block, as it contains the username.

## Condition Pattern Matching

The following description uses the Fortigate virus syslog message format as an example to describe condition pattern matching. The Fortigate virus syslog message takes the form:

```
Sep 26 18:30:02 log_id=0100030101 type=virus subtype=infected src=1.2.3.4
```

This message example contains the Fortigate virus log ID number 0100030101 (“log\_id=0100030101”), which can be used as the condition—the pattern that uniquely identifies this syslog message.

The parser expression that matches this condition is “log\_id=0100030101”. This is a narrow match on the specific log ID number shown in the message, or “log\_id=[0-9]{10}[ ]”, which is a regular expression that matches any Fortigate log entry with a ten-digit log ID followed by a space.

## User Pattern Matching

To extract the user identifier in the example Fortigate virus message shown above (“src=1.2.3.4”), use the following expression, “src=(.\*)[ ]” to parse the user information contained between the parentheses. The () block specifies where the username will be extracted. Only the first block will be processed.

### More examples:

Given a message wherein the username is a MAC address:

```
Sep 26 18:30:02 log_id=0100030101 type=virus subtype=infected mac 00:aa:bb:cc:dd:00
```

The expression “mac[ ](.{17})” will match “mac 00:aa:bb:cc:dd:00” in the example message.

Given a message wherein the username is a user name:

```
Sep 26 18:30:02 log_id=0100030101 type=virus subtype=infected user<johndoe>
```

The expression “user<(.\*)>” will match “user<johndoe>” in the example message.

## Configuring ESI

You can use the following interfaces to configure and manage ESI and ESI syslog parser behavior:

- The Web user interface (WebUI), which is accessible through a standard Web browser from a remote management console or workstation.
- The command line interface (CLI), which is accessible from a local console device connected to the serial port on the managed device or through a Telnet or Secure Shell (SSH) connection from a remote management console or workstation.



---

By default, you can access the CLI only from the serial port or from an SSH session. To use the CLI in a Telnet session, you must explicitly enable Telnet on the managed device. The general configuration descriptions in the following sections include both the WebUI pages and the CLI configuration commands. The configuration overview section is followed by several examples that show specific configuration procedures.

---

- The Aruba Management System, which is a suite of applications for monitoring Mobility Master and their related managed devices and APs. Each application provides a Web-based user interface. The Aruba Management System is available as an integrated appliance and as a software application that runs on a dedicated system. See the *ArubaOS User Guide* for more information.

In general, there are three ESI configuration “phases” on the managed device as a part of the solution:

- The first phase configures the ESI *ping health-check method, servers, and server groups*. The term *server* here refers to external server devices, for example, an AVF.
- The second phase configures the redirection policies instructing the managed device how to redirect the different types of traffic to different server groups.
- The final phase configures the ESI syslog parser domains and the rules that interpret and act on syslog message contents.



---

The procedures shown in the following sections are general descriptions. Your application might be broader or narrower than this example, but the same general operations apply.

---

### Configuring Health-Check Method, Groups, and Servers

To configure the ESI health-check method, servers, and server groups, navigate to the **Configuration > Services > External Services** view on the WebUI.

#### In the WebUI

1. In the **Managed Network** node hierarchy, navigate to the **Configuration > Services** page and select the **External Services** tab.
2. Click **General** accordion.
3. Click + in the **Health-Check Configuration** table. The **Create Health Check** table is displayed. (To change an existing profile, click the health check profile name.)
4. Provide the following details in the **Create Health Check** table:
  - a. Enter a **Profile Name**.
  - b. **Frequency (secs)**—Indicates how often the managed device checks to see if the server is up and running. Default: 5 seconds.
  - c. **Timeout (secs)**—Indicates the number of seconds the managed device waits for a response to its health check query before marking the health check as failed. Default: 2 seconds.
  - d. **Retry count**—Is the number of failed health checks after which the managed device marks the server as being down. Default: 2.
5. Click **Submit** to add a new health check profile.

6. Click **Pending Changes**.
7. In the **Pending Changes** window, select the check box and click **Deploy changes**.

### In the CLI

```
(host) [md] (config) # esi ping profile_name
    frequency seconds
    retry-count count
    timeout seconds
```

## Defining the ESI Server

The following sections describe how to configure an ESI server using the WebUI and CLI.

### In the WebUI

1. In the **Managed Network** node hierarchy, navigate to the **Configuration > Services** and select the **External Services** tab.
2. Click **General** accordion.
3. Click + in the **External Servers** table. The **Create Server** table is displayed.
4. Provide the following details in the **Create Server** table:
  - a. **Server Name**.
  - b. **Server Group**. Use the drop-down list to assign this server to a group from the existing configured groups.
  - c. **Server Mode**. Use the drop-down list to choose the mode (bridge, nat, or route) your topology requires. Refer to the description above to understand the differences between these modes.

For **routed** mode, enter the **Trusted IP Address** (the IP address of the trusted interface on the external server device) and the **Untrusted IP Address** (the IP address of the untrusted interface on the external server device). (You can also choose to enable a health check on either or both of these interfaces.)

For **bridged** mode, enter the **Trusted Port** number (the port connected to the trusted side of the ESI server) and the **Untrusted Port** number (the port connected to the untrusted side of the ESI server).

For **NAT** mode, enter the **Trusted IP Address** (the trusted interface on the external server) and the **NAT Destination Port** number (the port a packet is redirected to rather than the original destination port in the packet). You can also choose to enable a health check on the trusted IP address interface.
5. Click **Submit**.
6. Click **Pending Changes**.
7. In the **Pending Changes** window, select the check box and click **Deploy changes**.

### In the CLI

```
(host) [md] (config)#esi server server_identity
    dport destination_tcp/udp_port
    mode {bridge | nat | route}
    trusted-ip-addr ip-addr [health-check]
    trusted-port <slot/module/port>
    untrusted-ip-addr ip-addr [health-check]
    untrusted-port <slot/module/port>
```

## Defining the ESI Server Group

The following sections describe how to configure an ESI server group using the WebUI and CLI.

## In the WebUI

1. In the **Managed Network** node hierarchy, navigate to the **Configuration > Services** and select the **External Services** tab.
2. Click **General** accordion.
3. Click + in the **Server Groups** table. The **Create Server Group** table is displayed.  
(To change an existing group, click the name of the server group you want to edit.)
4. Provide the following details in the **Create Server Group** table:
  - a. Enter a **Group Name**.
  - b. In the drop-down list, select a health check profile.
5. Click **Submit**.
6. Click **Pending Changes**.
7. In the **Pending Changes** window, select the check box and click **Deploy changes**.

## In the CLI

```
(host) [md] (config)#esi group name
    ping profile_name
    server server_identity
```

## Policies and User Role

The following sections describe how to configure the redirection policies and user role using the WebUI and CLI.

### In the WebUI

1. To configure user roles to redirect the required traffic to the server(s), in the **Managed Network** node hierarchy, navigate to **Configuration > Roles & Policies**.
2. Click + to create a new user role.
3. To add a new role, click +. The **New Role** section is displayed.  
To change an existing role, click on the role name for the rules to be changed.
4. Enter the **Name** for the role and click **Apply**.
5. To add a policy for the new role, select the name of the role. The **roles > <name of the role>** table is displayed.
6. Click **Show Advanced View** on the table head. The **Policies** tab is now visible.
7. Click + in the Policies table. The **Add Policy** section is displayed.  
Choose from existing configured policies, create a new policy based on existing policies, or create a new policy.
  - a. If you elect to create a new policy, click on the **Create New Policy** option.
  - b. Enter the **Policy Name** and click **Submit**.
8. To add a rule to a policy, click the Policy name. The **Role > Policy** table is displayed.
9. Click + to add a new rule. The **New rule for <policy name>** is displayed.
  - c. Select the **Rule Type** as **Access Control**. The New rules for the rule type table is displayed.
  - d. Select IPv4 for the IP Version from the drop-down list.
  - e. Select **Source, Destination, Service/app** from their respective drop-down lists.
  - f. In the Action drop-down list, select the **redirect** option.
  - g. In the **Redirected to** drop-down list, select the ESI group.

- h. Select **ESI Direction. Forward** refers to the direction of traffic from the (untrusted) client or user to the (trusted) server (such as the HTTP server or email server).
- 10. Click **Submit**.
- 11. Click **Pending Changes**.
- 12. In the **Pending Changes** window, select the check box and click **Deploy changes**.
- 13. Refer to [Roles and Policies on page 367](#), for directions on how to apply a policy to a user role.

### In the CLI

```
(host) [md] (config)#ip access-list session policy
  any any any redirect esi-group group direction both blacklist
  //For any incoming traffic, going to any destination,
  //redirect the traffic to servers in the specified ESI group.
  any any any permit
  //For everything else, allow the traffic to flow normally.

(host) [md] (config)#user-role role
  access-list {eth | mac | session}
  bandwidth-contract name
  captive-portal name
  dialer name
  pool {l2tp | pptp}
  reauthentication-interval minutes
  session-acl name
  vlan vlan_id
```

## ESI Syslog Parser Domains and Rules

The following sections describe how to manage syslog parser domains using the WebUI and CLI.

### In the WebUI

To configure the ESI syslog parser, in the **Managed Network** node hierarchy, navigate to the **Configuration > Services > External Services** view on the WebUI.

Click on the **Syslog Parser Domains** accordion to display the Syslog Parser Domains table.

This view lists all the domains by domain name and server IP address, and includes a list of peer managed device (when peer managed device have been configured—as described in [Understanding the ESI Syslog Parser on page 1000](#)).

#### Adding a new syslog parser domain

1. In the **Managed Network** node hierarchy, navigate to the **Configuration > Services > External Services**
2. Click on the **Syslog Parser Domains** accordion
3. Click + in the **Syslog Parser Domains** table. The **New Syslog Parser Domain** is displayed.
4. In the **Domain** text box, type the name of the domain to be added.
5. In the **Server** field, click + in the **IP ADDRESS** table and the **Add Server IP Address** is displayed.
6. In the **Add server IP address** box, enter a valid IP address and click **OK**.




---

You must ensure that you type a valid IP address, because the IP address you type is not automatically validated against the list of external servers that has been configured.

---

7. In the **Peer Controller** field, click + in the **IP ADDRESS** table and the **Add Peer IP Address** is displayed.
8. In the **Add Peer IP address** box, enter a valid IP address and click **OK**.
9. Click **Submit**.

10. Click **Pending Changes**.
11. In the **Pending Changes** window, select the check box and click **Deploy changes**.

### Deleting an existing syslog parser domain

1. In the **Managed Network** node hierarchy, navigate to the **Configuration > Services > External Services**
2. Click on the **Syslog Parser Domains** accordion
3. Identify the target parser domain in the list shown in the **Domain** section of the **Syslog Parser Domains** view.
4. Click **Delete** icon on the same row.
5. Click **Submit**.
6. Click **Pending Changes**.
7. In the **Pending Changes** window, select the check box and click **Deploy changes**.

### Editing an existing syslog parser domain

1. In the **Managed Network** node hierarchy, navigate to the **Configuration > Services > External Services**
2. Click on the **Syslog Parser Domains** accordion
3. Identify the target parser domain in the list shown in the **Syslog Parser Domains** view. (see [In the WebUI on page 1006](#))
4. Click on domain name you want to edit and the system displays the edit domain view.



---

You cannot modify the domain name when editing a parser domain.

---

5. To delete a server from the selected domain, highlight the server IP address and click **Delete** icon and then click **Submit**.
6. To delete a **Peer controller** server from the selected domain, highlight the **Peer controller** IP address and click **Delete** icon.
7. Click **Submit**.
8. Click **Pending Changes**.
9. In the **Pending Changes** window, select the check box and click **Deploy changes**.

When you make a change in the domain, you can click the **View Commands** link in the lower right corner of the window to see the CLI command that corresponds to the edit action you performed.

### In the CLI

Use these CLI commands to manage syslog parser domains.

#### Adding a new syslog parser domain

```
(host) [md] (config)#esi parser domain name
peer peer-ip
server ipaddr
```

#### Showing ESI syslog parser domain information

```
(host) [md] #show esi parser domains
```

#### Deleting an existing syslog parser domain

```
(host) [md] (config) #no esi parser domain name
```

## Editing an existing syslog parser domain

```
(host) [md] (config) #esi parser domain name
no
peer peer-ip
server ipaddr
```

## Managing Syslog Parser Rules

The following sections describe how to manage syslog parser rules using the WebUI and CLI.

### In the WebUI

Click on the **Syslog Parser Rules** accordion to display the Syslog Parser Rules view. This view displays a table of rules with the following columns:

- Name— rule name
- Ena—where “y” indicates the rule is enabled and “n” indicates the rule is disabled (not enabled)
- Condition—Match condition (a regular expression)
- Match—Match type (IP address, MAC address, or user)
- User—Match pattern (a regular expression)
- Set—Set type (blacklist or role)
- Value—Set value (role name)
- Domain—Parser domain to which this rule is to be applied
- + —The actions that can be performed on each rule.

### Adding a new parser rule

To add a new syslog parser rule:

1. In the **Managed Network** node hierarchy, navigate to the **Configuration > Services > External Services**
2. Click on the **Syslog Parser Rules** accordion.
3. Click + in the **Syslog Parser Rules** table. The **New Syslog Parser Rules** table is displayed.
4. In the **Rule Name** text box, type the name of the rule you want to add.
5. Click the **Enable** check box to enable the rule.
6. In the **Condition Pattern** text box, type the regular expression to be used as the condition pattern.  
For example, “log\_id=[0-9]{10}[ ]” to search for and match a 10-digit string preceded by “log\_id=” and followed by one space.
7. In the drop-down **Match** list, use the drop-down list to select the match type (ipaddr, mac, or user).
8. In the **Match Pattern** text box, type the regular expression to be used as the match pattern.  
For example, if you selected “mac” as the match type, type the regular expression to be used as the match pattern. You could use “mac[ ](.{17})” to search for and match a 17-character MAC address preceded by the word “mac” plus one space.
9. In the drop-down **Set** list, select the set type (blacklist or role).  
When you select **role** as the Set type, the system displays a second drop-down list. Click the list to display the possible choices and select the appropriate role value. Validation on the entered value will be based on the Set selection.
10. In the drop-down **Parser Group** list, select one of the configured parser domain names.
11. Click **Submit**.
12. Click **Pending Changes**.
13. In the **Pending Changes** window, select the check box and click **Deploy changes**.



## Deleting a syslog parser rule

To delete an existing syslog parser rule:

1. Identify the target parser rule in the list shown in the **Syslog Parser Rules** view.
2. Click **Delete** icon on the same row.
3. Click **Submit**.
4. Click **Pending Changes**.
5. In the **Pending Changes** window, select the check box and click **Deploy changes**.

## Editing an existing syslog parser rule

To change an existing syslog parser rule:

1. In the **Managed Network** node hierarchy, navigate to the **Configuration > Services > External Services**
2. Click on the **Syslog Parser Rules** accordion.
3. Identify the target parser rule in the list shown in the **Syslog Parser Rules** view.
4. Click on the syslog parser rule name and edit the fields.



---

You cannot modify the rule name when editing a parser rule.

---

5. Change the other rule attributes as required:
  - a. Click the **Enable** check box to enable the rule.
  - b. In the **Condition Pattern** text box, type the regular expression to be used as the condition pattern.
  - c. In the drop-down **Match** list, select the match type (ipaddr, mac, or user).
  - d. In the **Match Pattern** text box, type the regular expression to be used as the match pattern.
  - e. In the drop-down **Set** list, select the set type (blacklist or role).
  - f. When you select **role** as the Set type, the system displays a second drop-down list. Click the list to display the possible choices and select the appropriate role value. Validation on the entered value will be based on the Set selection.
  - g. In the drop-down **Parser Group** list, select one of the configured parser domain names.



---

At this point, you can test the rule you just edited by using the System Parser Test accordion (accessed from the External Services tab by clicking the Syslog Parser Test accordion, described in [Testing a Parser Rule on page 1009](#)).

---

6. Click **Submit**.
7. Click **Pending Changes**.
8. In the **Pending Changes** window, select the check box and click **Deploy changes**.

## Testing a Parser Rule

You can test or validate enabled Syslog Parser rules against a sample syslog message, or against a syslog message file containing multiple syslog messages. Access the parser rules test from the **External Services** tab by clicking the **Syslog Parser Test** tab, which displays the Syslog Parser Rule Test view.

To test against a sample syslog message:

- a. In the drop-down **Test Type** list, select **Syslog message** as the test source type.
- b. In the **Filename** text box, type the syslog message text.
- c. Click **Test** to start the test.

The test results are displayed in a box in the area below the Test button. The test results contain information about the matching rule and match pattern.

- To test against a syslog message file:
  - a. In the drop-down **Test Type** list, select **Syslog file** as the test type.
  - b. In the **Filename** text box, type the syslog file name.
  - c. Click **Test** to start the test.

The test results are displayed in a box in the area below the Test button. The test results contain information about the matching rule and match pattern.

## In the CLI

Use these CLI commands to manage syslog parser rules.

### Adding a new parser rule

```
(host) [md] (config) #esi parser rule rule-name
    condition expression
    domain name
    enable
    match {ipaddr expression | mac expression | user expression}
    position position
    set {blacklist | role role}
```

### Showing ESI syslog parser rule information

```
(host) [md] #show esi parser rules
```

### Deleting a syslog parser rule

```
(host) [md] (config) #no esi parser rule rule-name
```

### Editing an existing syslog parser rule

```
(host) [md] (config) #esi parser rule rule-name
    condition expression
    domain name
    enable
    match {ipaddr expression | mac expression | user expression}
    no
    position position
    set {blacklist | role role}
```

### Testing a parser rule

```
(host) [md] (config) #esi parser rule rule-name
    test {file filename | msg message}
```

## Monitoring Syslog Parser Statistics

The following sections describe how to monitor syslog parser statistics using the CLI.

## In the CLI

```
(host) [md] #show esi parser stats
```

## Sample Route-Mode ESI Topology

This section introduces the configuration for a sample route-mode topology using the managed device and Fortinet Anti-Virus gateways. In route mode, the trusted and untrusted interfaces between the managed

device and the Fortinet gateways are on different subnets. The following figure shows an example route-mode topology.

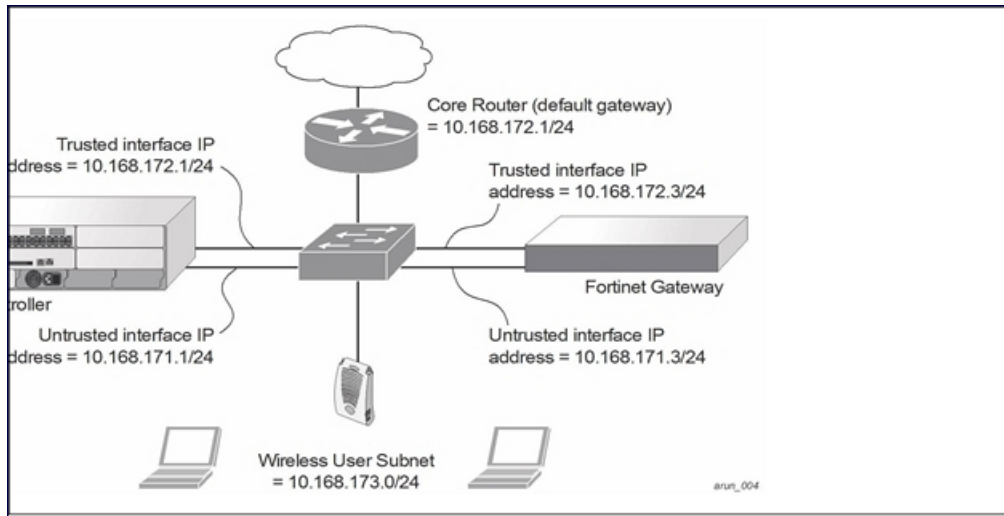


---

ESI with Fortinet Anti-Virus gateways is supported only in route mode.

---

**Figure 122** Example Route-Mode Topology



In the topology shown, the following configurations are entered on the managed device and Fortinet gateway:

### ESI server configuration on the managed device

- Trusted IP address = 10.168.172.3 (syslog source)
- Untrusted IP address = 10.168.171.3
- Mode = route

### IP routing configuration on the Fortinet gateway

- Default gateway (core router) = 10.168.172.1
- Static route for wireless user subnet (10.168.173.0/24) through the managed device (10.168.171.2)

## Configuring the Example Routed ESI Topology

This section describes how to implement the example routed ESI topology. The description includes the relevant configuration—both the WebUI and the CLI configuration processes are described—required on the managed device to integrate with a AVF server appliance.

The ESI configuration process will redirect all HTTP user traffic to the Fortinet server for examination, and any infected user will be blacklisted. The configuration process consists of these general tasks:

- Defining the ESI server.
- Defining the default ping health check method.
- Defining the ESI group.
- Defining the HTTP redirect filter for sending HTTP traffic to the ESI server.
- Applying the firewall policy to the guest role.
- Defining ESI parser domains and rules.

There are three configuration “phases” on the managed device as a part of the solution.

- The first phase configures the ESI *ping health-check method, servers, and server groups*. The term *server* here refers to external AVF server devices.
- In the second phase of the configuration task, the user roles are configured with the redirection policies (session ACL definition) instructing the managed device to redirect the different types of traffic to different server groups.
- In the final phase, the ESI parser domains and rules are configured.




---

The procedures shown in the following sections are based on the requirements in the example routed ESI topology. Your application might be broader or narrower than this example, but the same general operations apply.

---

## Health-Check Method, Groups, and Servers

To configure the ESI health-check method, servers, and server groups, navigate to the **Configuration > Advanced Services > External Services** view on the WebUI.

### Defining the Ping Health-Check Method

#### In the WebUI

1. In the **Managed Network** node hierarchy, navigate to the **Configuration > Services** and click on the **External Services** tab on the WebUI.
2. Click **+** in the **Health-Check Configuration** table under the **General** accordion on the WebUI. The **Create Health Check** table is displayed.
3. Provide the following details in the **Create Health Check** table:
  - a. Enter the name **default for the Profile Name**.
  - b. **Frequency (secs)**—Enter **5**.)
  - c. **Timeout (secs)**—Indicates the number of seconds the managed device waits for a response to its health check query before marking the health check as failed. Default: 2 seconds. (In this example, enter **3**.)
  - d. **Retry count**—Is the number of failed health checks after which the managed device marks the server as being down. Default: 2. (In this example, enter **3**.)
4. Click **Submit**.
5. Click **Pending Changes**.
6. In the **Pending Changes** window, select the check box and click **Deploy changes**.

#### In the CLI

```
(host) [md] (config) #esi ping profile_name
    frequency seconds
    retry-count count
    timeout seconds
```

### Defining the ESI Server Group

The following sections describe how to configure an ESI server group using the WebUI and CLI.

#### In the WebUI

1. In the **Managed Network** node hierarchy, navigate to the **Configuration > Services** and click on the **External Services** tab on the WebUI
2. Click **+** in the **Server Groups** table. The **Create Server Group** table is displayed.
3. Provide the following details in the **Create Server Group** table:
  - a. Enter a **Group Name**. Enter **fortinet**.

- b. In the drop-down list, select **default** as the health check profile.
4. Click **Submit**.
5. Click **Pending Changes**.
6. In the **Pending Changes** window, select the check box and click **Deploy changes**.

### In the CLI

```
(host) [md] (config) #esi group name
ping profile_name
server server_identity
```

## Defining the ESI Server

The following sections describe how to configure an ESI server using the WebUI and CLI.

### In the WebUI

1. In the **Managed Network** node hierarchy, navigate to the **Configuration > Services** and click on the **External Services** tab on the WebUI
2. Click **+** in the **External Servers** table. The **Create Server** table is displayed.
3. Provide the following details in the **Create Server** table:
  - a. **Server Name**. (This example uses the name **forti\_1**.)
  - b. **Server Group**. Use the drop-down list to assign this server to a group from the existing configured groups. (This example uses **fortinet**.)
  - c. **Server Mode**. Use the drop-down list to choose the mode (bridge, nat, or route) your topology requires. Refer to the description above to understand the differences between the modes. (This example uses **route** mode.)
  - d. **Trusted IP Address**. Enter **10.168.172.3**.)
  - e. **Untrusted IP Address**. Enter **10.168.171.3**.)
4. Click **Submit**.
5. Click **Pending Changes**.
6. In the **Pending Changes** window, select the check box and click **Deploy changes**.

### In the CLI

```
(host) [md] (config) #esi server server_identity
dport destination_tcp/udp_port
mode {bridge | nat | route}
trusted-ip-addr ip-addr [health-check]
trusted-port <slot/module/port>
untrusted-ip-addr ip-addr [health-check]
untrusted-port <slot/module/port>
```

## Redirection Policies and Role

The following sections describe how to configure the redirection policies and user role using the WebUI and CLI.

### In the WebUI

1. To configure user roles to redirect the required traffic to the server(s), in the **Managed Network** node hierarchy, navigate to **Configuration > Roles & Policies > Roles** tab.
2. Click **+** to create a new user role.
3. Enter **guest** for Role Name.

4. Click **Submit**.
5. Select **guest** role.
6. Click **Show Advanced View**.
7. Click + in **Roles > guest** table.
8. Click **Policies** tab. Click + to create a new policy.
9. In the **Add Policy** popup, select the **Create a new policy** option. Enter the **Policy Name** as **fortinet** and select **Policy type** as **Session** from the drop-down list.
10. Click **Submit**.
11. Select the **fortinet** policy under the **Roles > guest** table.
12. Click + in the **guest Policies > fortinet** table.
13. Select **Access Control** as the **Rule Type** in **New Rule for guest** popup.
14. Enter the following information in the **Roles > fortinet > New forwarding Rule** table.
  - IP version as **IPv4**.
  - Source as **Any**.
  - Destination as **Any**.
  - Service/app as **Protocol** and the Protocol as **svc-http (tcp 80)**.
  - Action as **Redirect**.
    - Enter **Redirect to** as **ESI Group**.
    - Enter **Esi group** as **fortinet**.
    - Select **Esi direction** as **Both**. **Forward** refers to the direction of traffic from the untrusted client or user to the trusted server, such as the HTTP server or email server.
15. Click **Submit**.
16. Repeat the steps to configure additional rules. This example adds a rule that specifies **any, any, any, permit**.
17. Click **Submit**.
18. Click **Pending Changes**.
19. In the **Pending Changes** window, select the check box and click **Deploy changes**.

## In the CLI

Use these commands to define the redirection filter for sending traffic to the ESI server and apply the firewall policy to a user role in the route-mode ESI topology example.

```
(host) [md] (config) #ip access-list session policy
    any any any redirect esi-group group direction both blacklist
    //For any incoming traffic, going to any destination,
    //redirect the traffic to servers in the specified ESI group.
    any any any permit
    //For everything else, allow the traffic to flow normally.
```

```
(host) [md] (config) #user-role role
    access-list {eth | mac | session}
    bandwidth-contract name
    captive-portal name
    dialer name
    pool {l2tp | pptp}
    reauthentication-interval minutes
    session-acl name
    vlan vlan_id
```

## Syslog Parser Domain and Rules

The following sections describe how to configure the syslog parser domain and rules for the route-mode example using the WebUI and CLI.

### In the WebUI

#### Adding a New Syslog Parser Domain

To add a new syslog parser domain for the routed example:

1. Click + in the **Syslog Parser Domains** table. The **New Syslog Parser Domain** is displayed.
2. In the **Domain** text box, type the name of the domain to be added.
3. In the **Server** field, click + in the **IP ADDRESS** table and the **Add Server IP Address** is displayed.
4. In the **Add server IP address** box, enter a valid IP address and click **OK**.



---

You must ensure that you type a valid IP address, because the IP address you type is not automatically validated against the list of external servers that has been configured.

---

5. In the **Peer Controller** field, click + in the **IP ADDRESS** table and the **Add Peer IP Address** is displayed.
6. In the **Add Peer IP address** box, enter a valid IP address and click **OK**.
7. Click **Submit**.
8. Click **Pending Changes**.
9. In the **Pending Changes** window, select the check box and click **Deploy changes**.

#### Adding a New Parser Rule

To add a new syslog parser rule for the route-mode example:

1. Click + in the **Syslog Parser Rules** table. The **New Syslog Parser Rules** table is displayed.
2. In the **Rule Name** text box, type the name of the rule to be added (in this example, "forti\_virus").
3. Click the **Enable** check box to enable the rule.
4. In the **Condition Pattern** text box, type the regular expression to be used as the condition pattern. (In this example, the expression "log\_id=[0-9]{10}[ ]" searches for and matches a 10-digit string preceded by "log\_id=" and followed by one space.)
5. In the drop-down **Match** list, use the drop-down list to select the match type (in this example, ipaddr).
6. In the **Match Pattern** text box, type the regular expression to be used as the match pattern (in this example, "src=(. \*)[ ]").
7. In the drop-down **Set** list, select the set type (in this example, blacklist).
8. In the drop-down **Parser Group** list, select one of the configured parser domain names (in this example, "forti\_domain").
9. Click **Submit**.
10. Click **Pending Changes**.
11. In the **Pending Changes** window, select the check box and click **Deploy changes**.

### In the CLI

Use these CLI commands to define a syslog parser domain and the rule to be applied in the route-mode example shown in [Figure 122](#).

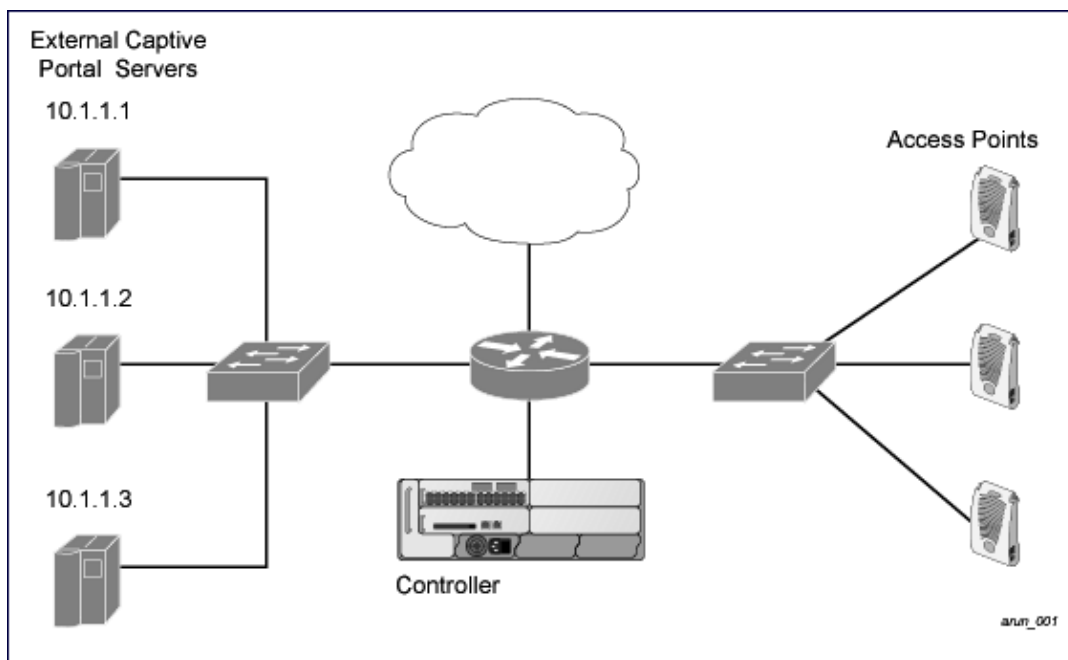
```
(host) [md] (config) #esi parser domain name
peer peer-ip
server ipaddr
```

```
(host) [md] (config) #esi parser rule rule-name
    condition expression
    domain name
    enable
    match {ipaddr expression | mac expression | user expression }
    position position
    set {blacklist | role role}
```

## Sample NAT-mode ESI Topology

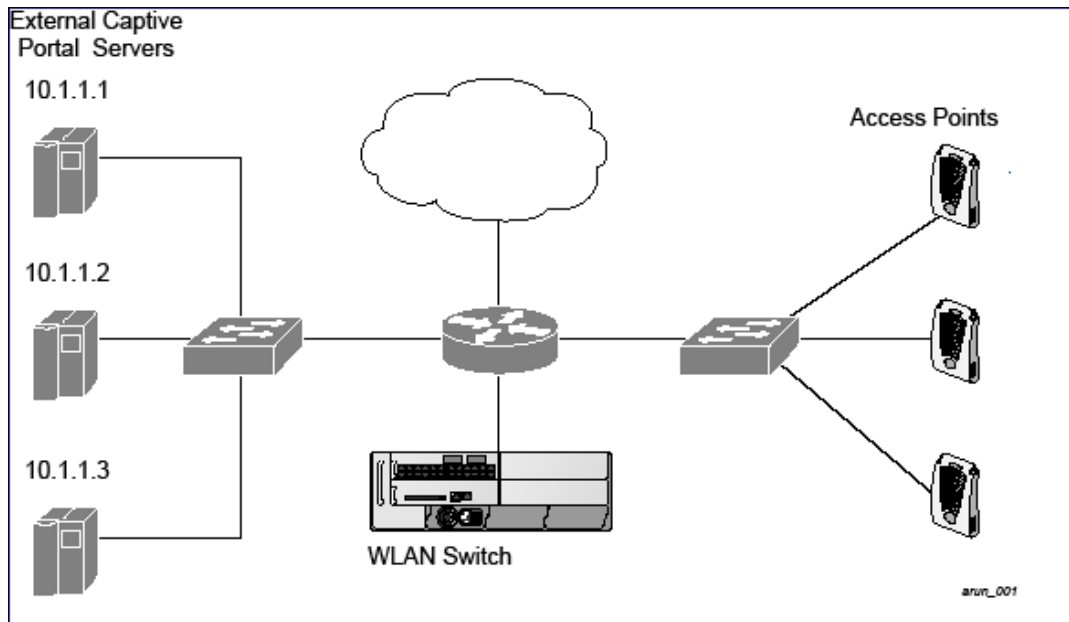
This section describes the configuration for a sample NAT-mode topology using the managed device and three external captive-portal servers. NAT mode uses a trusted interface for each external captive-portal server and a different destination port to redirect a packet to a port other than the original destination port in the packet. An example topology is shown below in [Figure 124](#).

**Figure 123** Example NAT-Mode Topology





**Figure 124**



In this example, all HTTP traffic received by the managed device is redirected to the external captive portal server group and load-balanced across the captive portal servers. All wireless client traffic with destination port 80 is redirected to the captive portal server group, with the new destination port 8080.



The external servers do not necessarily have to be on the subnet as the managed device. The policy that redirects traffic to the external servers for load balancing is routed to the external servers if they are on a different subnet.

In the topology shown, the following configurations are entered on the managed device and external captive-portal servers:

### ESI server configuration on the managed device

- External captive-portal server 1:
  - Name = external\_cp1
  - Mode = NAT
  - Trusted IP address = 10.1.1.1
  - Alternate destination port = 8080
- External captive-portal server 2:
  - Name = external\_cp2
  - Mode = NAT
  - Trusted IP address = 10.1.1.2
- External captive-portal server 3:
  - Name = external\_cp3
  - Mode = NAT
  - Trusted IP address = 10.1.1.3
- Health-check ping:
  - Name = externalcp\_ping
  - Frequency = 30 seconds
  - Retry-count = 2 attempts

- Timeout = 2 seconds (2 seconds is the default)
- ESI group = external\_cps
- Session access control list (ACL)
  - Name = cp\_redirect\_acl
  - Session policy = user any svc-http redirect esi-group external\_cps direction both

## Configuring the Example NAT-mode ESI Topology

This section describes how to implement the example NAT-mode ESI topology shown in using both the WebUI, then the CLI.

The configuration process consists of these general tasks:

- Configuring captive portal (see the “Configuring Captive Portal” chapter).
- Configuring the health-check ping method.
- Configuring the ESI servers.
- Configuring the ESI group.
- Defining the redirect filter for sending traffic to the ESI server.

## Configuring the NAT-mode ESI Example in the WebUI

on the WebUI.

### In the WebUI

#### Configuring a Health-Check Ping

1. In the **Managed Network** node hierarchy, navigate to the **Configuration > Services** and click on the **External Services** tab
2. Click + in the **Health-Check Configuration** table under the **General** accordion on the WebUI. The **Create Health Check** table is displayed.
3. Provide the following details in the **Create Health Check** table:
  - a. **Profile Name**. This example uses **externalcp\_ping**.
  - b. **Frequency** seconds. This example uses **30**.
  - c. **Retry Count**. This example uses **3**.




---

If you do not specify a value for a parameter, the WebUI assumes the default value. In this example, the desired timeout value is two seconds; therefore, not specifying the timeout causes the WebUI to use the default value of two seconds.

---

4. Click **Submit**.

#### Configuring the ESI Group

1. In the **Managed Network** node hierarchy, navigate to the **Configuration > Services** and click on the **External Services** tab on the WebUI.
2. Click + in the Server Groups table. The **Create Server Group** table is displayed.
3. Provide the following details in the **Create Server Group** table :
  - a. **Group Name**. This example uses **external\_cps**.
  - b. **Health-Check Profile**. Select the health-check ping from the drop-down list. This example uses **externalcp\_ping**.
4. Click **Submit** when you are finished.

## Configuring the ESI Servers

1. Click **+** in the **External Servers** table. The **Create Server** table is displayed.
2. Provide the following details in the **Create Server** table:
  - a. **Server Name**.
  - b. **Server Group**. Use the drop-down list to assign this server to a group from the existing configured groups.
  - c. **Server Mode**. Use the drop-down list to choose NAT mode.)
  - d. **Trusted IP Address**. For nat mode, enter the IP address of the trusted interface on the external captive portal server.
  - e. **NAT Destination Port**. Enter the port number (to redirect a packet to a port other than the original destination port in the packet).
3. Click **Submit** when you are finished.
4. Repeat Step 1 through Step 3 for the remaining external captive portal servers.
5. Click **Submit** to apply the configuration changes.

## Configuring the Redirection Filter

To redirect the required traffic to the server(s) using the WebUI, navigate to the **Configuration > Roles and Policies**.

### In the WebUI

1. To configure user roles to redirect the required traffic to the server(s), in the **Managed Network** node hierarchy, navigate to **Configuration > Roles & Policies > Roles** tab.
2. Click **+** to create a new user role.
3. Enter **guest** for Role Name.
4. Click **Submit**.
5. Select **guest** role.
6. Click **Show Advanced View**.
7. Click **+** in **Roles > guest** table.
8. Click **Policies** tab. Click **+** to create a new policy.
9. In the **Add Policy** popup, select the **Create a new policy** option. Enter the **Policy Name** as **fortinet** and select **Policy type** as **Session** from the drop-down list.
10. Click **Submit**.
11. Select the **cp\_redirect\_acl** policy under the **Roles > guest** table.
12. Click **+** in the **guest Policies > cp\_redirect\_acl** table.
13. Select **Access Control** as the **Rule Type** in **New Rule for guest** popup.
14. Enter the following information in the **Roles > fortinet > New forwarding Rule** table.
  - IP version as **IPv4**.
  - Source as **User**.
  - Destination as **Any**.
  - Service/app as **Service** and the Protocol as **svc-http (tcp 80)**.
  - Action as **Redirect**.
    - Enter **Redirect to** as **ESI Group**.
    - Enter **Esi group** as **fortinet**.

- Select **Esi direction** as **Both**. **Forward** refers to the direction of traffic from the untrusted client or user to the trusted server, such as the HTTP server or email server.

15. Click **Submit**.

16. Click **Pending Changes**.

17. In the **Pending Changes** window, select the check box and click **Deploy changes**.

## In the CLI

The CLI configuration process consists of these general tasks:

- Configuring captive portal (see [Captive Portal Authentication on page 286](#)).
- Configuring the health-check ping method.
- Configuring the ESI servers.
- Configuring the ESI group.
- Defining the redirect filter for sending traffic to the ESI server.

### Configuring a Health-Check Ping

The health-check ping will be associated with an ESI group, along with servers, so that managed device will send ICMP echo requests to each server in the group and mark the server down if the managed device does not hear from the server. The health-check parameters used in this example are:

- Frequency—30 seconds. (The default is 5 seconds.)
- Retry-count—3. (The default is 2.)
- Timeout—2 seconds. (The default is 2 seconds.)

Use these CLI commands to configure a health-check ping method:

```
(host) [md] (config) #esi ping profile_name
    frequency seconds
    retry-count count
    timeout seconds
```

### Configuring ESI Servers

Here are the ESI server CLI configuration tasks:

- Configure server mode to be NAT.
- Configure the trusted IP address (the server IP address to which packets should be redirected).
- To redirect to a different port than the original destination port in the packet, configure an alternate destination port.

Use these CLI commands to configure an ESI server and identify its associated attributes:

```
(host) [md] (config) #esi server server_identity
    dport destination_tcp/udp_port
    mode {bridge | nat | route}
    trusted-ip-addr ip-addr [health-check]
```

### Configuring an ESI Group, Add the Health-Check Ping and ESI Servers

Use these CLI commands to configure an ESI server group, identify its associated ping health-check method, and associate a server with this group:

```
(host) [md] (config) #esi group name
    ping profile_name
    server server_identity
```

### Using the ESI Group in a Session Access Control List

Use these CLI commands to define the redirection filter for sending traffic to the ESI server.

```
(host) [md] (config) #ip access-list session policy
    user any svc-http redirect esi-group group direction both
```

## Understanding Basic Regular Expression (BRE) Syntax

The ESI syslog parser supports regular expressions created using the Basic Regular Expression (BRE) syntax described in this section. BRE syntax consists of instructions—character-matching operators (described in [Table 231](#)), repetition operators (described in [Table 232](#)), or expression anchors (described in [Table 233](#))—used to defined the search or match target.

This section contains the following topics:

- “Character-Matching Operators” on page 512
- “Regular Expression Repetition Operators” on page 513
- “Regular Expression Anchors” on page 513
- “References” on page 514

### Character-Matching Operators

**Character-matching operators** define what the search will match.

**Table 231:** *Character-matching operators in regular expressions*

Operator	Description	Sample	Result
.	Match any one character.	grep .ord sample.txt	Matches <i>ford, lord, 2ord</i> , etc. in the file sample.txt.
[ ]	Match any one character listed between the brackets	grep [cng]ord sample.txt	Matches only <i>cord, nord</i> , and <i>gord</i>
[^]	Match any one character not listed between the brackets	grep [^cn]ord sample.txt	Matches <i>lord, 2ord</i> , etc., but not <i>cord</i> or <i>nord</i>
		grep [a-zA-Z]ord sample.txt	Matches <i>aord, bord, Aord, Bord</i> , etc.
		grep [^0-9]ord sample.txt	Matches <i>Aord, aord</i> , etc., but not <i>2ord</i> , etc.

### Regular Expression Repetition Operators

**Repetition operators** are *quantifiers* that describe how many times to search for a specified string. Use them in conjunction with the character-matching operators in [Table 232](#) to search for multiple characters.

**Table 232:** Regular expression repetition operators

Operator	Description	Sample	Result
?	Match any character one time if it exists	egrep "?erd" sample.txt	Matches <i>berd, herd, etc., erd</i>
*	Match declared element multiple times if it exists	egrep "n.*rd" sample.txt	Matches <i>nerd, nrd, neard, etc.</i>
+	Match declared element one or more times	egrep "[n]+erd" sample.txt	Matches <i>nerd, nnerd, etc.,</i> but not <i>erd</i>
{n}	Match declared element exactly <i>n</i> times	egrep "[a-z]{2}erd" sample.txt	Matches <i>cherd, blerd, etc.,</i> but not <i>nerd, erd, buzzerd, etc.</i>
{n,}	Match declared element at least <i>n</i> times	egrep ".{2,}erd" sample.txt	Matches <i>cherd</i> and <i>buzzerd,</i> but not <i>nerd</i>
{n,N}	Match declared element at least <i>n</i> times, but not more than <i>N</i> times	egrep "n[e]{1,2}rd" sample.txt	Matches <i>nerd</i> and <i>neerd</i>

## Regular Expression Anchors

**Anchors** describe where to match the pattern, and are a handy tool for searching for common string combinations. Some of the anchor examples use the vi line editor command `:`, which stands for *substitute*. That command uses the syntax: `s/pattern_to_match/pattern_to_substitute`.

**Table 233:** Regular expression anchors

Operator	Description	Sample	Result
^	Match at the beginning of a line	s/^/blah /	Inserts "blah" at the beginning of the line
\$	Match at the end of a line	s\$/ blah/	Inserts " blah" at the end of the line
\<	Match at the beginning of a word	s/\</blah/	Inserts "blah" at the beginning of the word
		egrep "\<blah" sample.txt	Matches <i>blahfield, etc.</i>
\>	Match at the end of a word	s/\>/blah/	Inserts "blah" at the end of the word

Operator	Description	Sample	Result
		egrep "\>blah" sample.txt	Matches <i>souptlah</i> , etc.
\b	Match at the beginning or end of a word	egrep "\bblah" sample.txt	Matches <i>blahcake</i> and <i>countblah</i>
\B	Match in the middle of a word	egrep "\Bblah" sample.txt	Matches <i>sublahper</i> , etc.

## References

This implementation is based, in part, on the following resources:

- Lonvick, C., "The BSD syslog Protocol", RFC 3164, August 2001
- Regular expression (regex) reference: [http://en.wikipedia.org/wiki/Regular\\_expression](http://en.wikipedia.org/wiki/Regular_expression)
- Regex syntax summary: <http://www.greenend.org.uk/rjk/2002/06/regexp.html>
- Basic regular expression (BRE) syntax: <http://builder.com.com/5100-6372-1050915.html>

This chapter introduces the ArubaOS XML API interface and briefly discusses how you can use simple API calls to perform external user management tasks. Sample scripts are listed at the end of the chapter to help you get started with using the XML API.

Topics in this chapter include:

- [Overview on page 1024](#)
- [How the ArubaOS XML API Works on page 1024](#)
- [Creating an XML Request on page 1024](#)
- [XML Response on page 1027](#)
- [Sample Scripts on page 1037](#)

## Overview

ArubaOS allows you to set up customized external captive portal user management using its native XML API interface. The XML API interface allows you to create and execute user management operations on behalf of the clients or users. You can use the XML API interface to add, delete, authenticate, blacklist, query, or log out a user.

### Before you Begin

- XML API requires the PEFNG license.
- Ensure that you have connectivity between your XML API server and the Mobility Master via HTTPS.

## How the ArubaOS XML API Works

Typical interaction between your XML API server and Mobility Master happens using an HTTPS POST command. A typical communication process using the XML API interface happens as follows:

1. An API command is issued from your server in XML format to Mobility Master. The XML request can be composed using a language of your choice using the format described in the [Creating an XML Request on page 1024](#). Sample scripts are available in Python or Bourne Shell, using cURL to generate the HTTPS POST command. See the [Sample Scripts on page 1037](#).
2. The XML request is sent using an HTTPS POST command. The common format of the HTTPS POST is **https://<Mobility Master-ip>/auth/command.xml**. See [Creating an XML Request on page 1024](#) for more information.
3. Mobility Master processes the XML API request and sends the response to the XML API server. You can use the response and take appropriate action that suits your requirement. The response from Mobility Master is returned using predefined formats. See the [XML Response on page 1027](#) for more information.

## Creating an XML Request

You can create XML request to add, delete, authenticate, blacklist, query, or logout a user. This section provides XML request formats that you can use for each task.





---

The XML API functions such as addition, deletion, authentication, blacklisting, querying, and logout have been extended to support IPv6 users in addition to IPv4 users. However, the XML API server must be configured with an IPv4 address for communication with Mobility Master.

---

## Adding a User

This XML request uses the **user\_add** command to create a new user entry in the Mobility Master user table. If the user entry is already present in the user table, the command will modify the entry with the values defined in the XML request, with an exception of IP and MAC address. Session time-out is only applicable to captive portal users.

```
xml=<aruba command="user_add">
  <ipaddr>IP-address_of_the_user</ipaddr>
  <macaddr>MAC-address_of_the_user</macaddr>
  <name>User_Name</name>
  <role>Role_Name</role>
  <session_timeout>Session_timeout</session_timeout>
  <key>Shared_Key</key>
  <authentication>MD5|SHA-1|cleartext</authentication>
  <version>1.0</version>
</aruba>
```

The following options are mandatory when you execute the **user\_add** command:

- IP Address
- MAC Address (a valid wireless or wired client on the managed device)
- Key
- Authentication
- Version

## Deleting a User



---

Do not use the **user\_delete** command if the intention is to clear the association from the Mobility Master user table. If the client is dual-stack, it re-inherits the authentication state from the IPv6 address. If not dual-stack, the client reverts to the initial role.

---

This XML request uses the **user\_delete** command to delete an existing user from the Mobility Master user table.

```
xml=<aruba command="user_delete">
  <ipaddr>IP-address_of_the_user</ipaddr>
  <macaddr>MAC-address_of_the_user</macaddr>
  <name>User_Name</name>
  <key>Shared_Key</key>
  <authentication>MD5|SHA-1|cleartext</authentication>
  <version>1.0</version>
</aruba>
```

The following options are mandatory when you execute the **user\_delete** command:

- IP Address
- Key
- Authentication
- Version



---

Passing the MAC address or username serves only to perform additional validation against the mandatory IP address. For example, if the IP address is 1.2.3.4 and the MAC address passed is 00:11:22:33:44:55 but the real MAC address is 66:77:88:99:aa:bb then the XML request will fail with response code 1, "**unknown user**" message.

---

## Authenticating a User

This XML request uses the **user\_authenticate** command to authenticate against the server group defined in the captive portal profile. This is only applicable to captive portal users.

```
xml=<aruba command="user_authenticate">
  <ipaddr>IP-address_of_the_user</ipaddr>
  <macaddr>MAC-address_of_the_user</macaddr>
  <name>User_Name</name>
  <password>Password_for_the_user</password>
  <key>Shared_Key</key>
  <authentication>MD5|SHA-1|cleartext</authentication>
  <version>1.0</version>
</aruba>
```

The following options are mandatory when you execute the **user\_authenticate** command:

- IP Address
- Name
- Password
- Key
- Authentication
- Version



---

Passing the MAC address serves only to perform additional validation against the mandatory IP address. For example, if the IP address is 1.2.3.4 and the MAC address passed is 00:11:22:33:44:55 but the real MAC address is 66:77:88:99:aa:bb then the XML request will fail with response code 1, "**unknown user**" message.

---

## Blacklisting a User

This XML request uses the **user\_blacklist** command to blacklist a user from connecting to your network. This command uses the default blacklist timeout of 3600 seconds. There is no corresponding **clear** command. You can use the Mobility Master CLI to clear the blacklisted clients. Refer the **show ap blacklist-clients**, **stm remove-blacklist-client**, and **stm purge-blacklist-clients** commands in the *ArubaOS CLI Reference Guide* to clear the blacklisted clients.

```
xml=<aruba command="user_blacklist">
  <ipaddr>IP-address_of_the_user</ipaddr>
  <macaddr>MAC-address_of_the_user</macaddr>
  <name>User_Name</name>
  <key>Shared_Key</key>
  <authentication>MD5|SHA-1|cleartext</authentication>
  <version>1.0</version>
</aruba>
```

The following options are mandatory when you execute the **user\_blacklist** command:

- IP Address
- Key
- Authentication
- Version



---

Passing the MAC address or username serves only to perform additional validation against the mandatory IP address. For example, if the IP address is 1.2.3.4 and the MAC address passed is 00:11:22:33:44:55 but the real MAC address is 66:77:88:99:aa:bb then the XML request will fail with response code 1, "**unknown user**" message.

---

## Querying for User Status

This XML request uses the **user\_query** command to get the status and details of a user connected to your network. A dual-stack client can be queried by any of its IPv4 or IPv6 addresses, but only the queried IP address and corresponding values are displayed in the output.

```
xml=<aruba command="user_query">
  <ipaddr>IP-address_of_the_user</ipaddr>
  <macaddr>MAC-address_of_the_user</macaddr>
  <name>User_Name</name>
  <key>Shared_Key</key>
  <authentication>MD5|SHA-1|cleartext</authentication>
  <version>1.0</version>
</aruba>
```

The following options are mandatory when you execute the **user\_query** command:

- IP Address
- Key
- Authentication
- Version



---

Passing the MAC address or username serves only to perform additional validation against the mandatory IP address. For example, if the IP address is 1.2.3.4 and the MAC address passed is 00:11:22:33:44:55 but the real MAC address is 66:77:88:99:aa:bb then the XML request will fail with response code 1, "**unknown user**" message.

---

## Logging Out a User

This XML request uses the **user\_logout** command to revert the user to the initial role. This is only applicable to captive portal users. For dual-stack clients, all user-table entries will be reverted to the initial role.

```
xml=<aruba command="user_logout">
  <ipaddr>IP-address_of_the_user</ipaddr>
  <macaddr>MAC-address_of_the_user</macaddr>
  <name>User_Name</name>
  <key>Shared_Key</key>
  <authentication>MD5|SHA-1|cleartext</authentication>
  <version>1.0</version>
</aruba>
```

The following options are mandatory when you execute the **user\_logout** command:

- IP Address
- Key
- Authentication
- Version

## XML Response

For every successful XML request, Mobility Master will return the processed information as an XML response. There are two types of responses: Default response and Query response.

## Default Response Format

The format of a default XML response from Mobility Master is:

```
<aruba>
  <status>Ok | Error</status>
  <code>response_code</code>
  <reason>response_message</reason>
</aruba>
```

In which,

- the status specifies if the XML response succeeds or fails. If the request succeeds, the status tag will contain the **Ok** string. If the request fails, the status tag will contain the **Error** string.
- the code is an integer number that represents the error in the request. This tag is populated only if there is an error in the request.
- the reason is a message that contains descriptive information about the error.

## Response Codes

The following response codes are returned if the XML request returns an **Error** string.

**Table 234:** XML Response Codes

Code	Reason message	Description
1	<b>unknown user</b> The user specified in the XML request does not exist or is incorrect. If the MAC address or username is specified in the query, Mobility Master restricts the supplied IP address, i.e., the requested user IP address together with any MAC address and username will not be found.	Returned by the <b>user_authenticate</b> , <b>user_delete</b> , <b>user_blacklist</b> , <b>user_logout</b> , and <b>user_query</b> commands.
2	<b>unknown role</b> The specified role in the XML request does not exist in Mobility Master.	Returned by the <b>user_add</b> command.
3	<b>unknown external agent</b>	This error string is returned due to an unknown source IP (i.e. not configured as an XML server). Or, In case of an <b>user_add</b> command, it is likely to be due to the <b>default-xml-api</b> AAA profile missing from the AAA authentication wired profile.
4	<b>authentication failed</b>	Indicates an authentication failure during <b>user_authenticate</b> . This is only applicable to captive portal users.
5	<b>invalid command</b> The XML request contains a command not supported by ArubaOS XML API interface.	—

Code	Reason message	Description
6	<b>invalid message authentication method</b> The authentication method specified in the XML request is not supported by the ArubaOS XML API interface.	Returned by commands that contain the authentication method in the XML request.
7	<b>invalid message digest</b>	This is due to a mismatch in secret between the XML server and Mobility Master XML API profile. If using non cleartext, this could be an error in the calculation of the hashed secret.
8	<b>missing message authentication</b> The authentication method is not specified in the XML request.	Returned by all commands that require the authentication method in the XML request.
9	<b>missing or invalid version number</b> The XML request does not contain the version number or the version number is incorrect.	Returned by all commands.
10	<b>internal error</b>	—
12	<b>can't use vlan ip</b>	Indicates the supplied IP matches a VLAN IP on Mobility Master.
13	<b>invalid ip</b> The XML request contains invalid IP address of the user or client.	Returned by all commands that required IP address to be specified in the XML request.
14	<b>can't use switch ip</b> The XML request contains the Mobility Master IP address instead of the client IP address.	Returned by all commands that required IP address to be specified in the XML request.
15	<b>missing MAC address</b> The XML request does not contain the MAC address of the user or client.	Returned by all commands that required MAC address to be specified in the XML request.
16	<b>unsupported command for this user</b>	Returned when the requested operation is invalid for the specified user.
17	<b>socket failed or timed out waiting for operation to complete</b>	Returned when the status of the requested operation is unavailable; usually signifies a socket communication failure or timeout.

## Query Command Response Format

The response of the XML request with the **user\_query** command contains detailed information about the status of the user or client.

The **status**, **code** and **reason** values are similar to the default response. The following responses are returned only if the **status** code returns the **Ok** string.

**Table 235:** Query Response Code

Response Code	Description
status	Displays the status of the XML response.
code	Displays the code as an integer number that represents the error in the request. This tag is populated only if there is an error in the request.
macaddr	Displays the MAC address of the client.
ipaddr	Displays the IPv4 or IPv6 address of the client.
name	Displays the hostname of the user or client.
role	Displays the current role of the authenticated client.
type	Displays if the client is <b>wired</b> or <b>wireless</b> .
vlan	Displays the VLAN ID of the client.
location	Displays the name of the AP to which the client is associated.
age	Displays the age of the client in Mobility Master. The age is displayed in DD:HH:MM format (Day:Hours:Minutes).
auth_status	Displays the authentication status of the client. Available values are: <b>authenticated</b> or <b>unauthenticated</b> .
auth_server	Displays the name of the authentication server used for authenticating the client. This information is available only if the client is authenticated by Mobility Master.
auth_method	Displays the authentication mechanism used to authenticate the client. This information is available only if the client is authenticated by Mobility Master.
ssid	Displays the ESSID to which the client is associated.
bssid	Displays the BSSID of the AP to which the client is associated.
phy_type	Displays the physical connection type. Available values are: <b>a</b> , <b>b</b> , <b>g</b> , <b>a-HT</b> , <b>g-HT</b> , and <b>a-VHT</b> .
mobility_state	Displays the roaming state of the client. Available values are: <b>Wired (Visitor)</b> , <b>Visitor</b> , <b>Wired (Away)</b> , <b>Away</b> , <b>Wired (Foreign VLAN)</b> , <b>Foreign VLAN</b> , <b>Wired (Remote)</b> , <b>Associated (Remote)</b> , <b>Wired</b> , and <b>Wireless</b> .
in_packets	Displays the total number of incoming packets received by the client.

Response Code	Description
in_octets	Displays the incoming packets (in bytes) received by the client.
out_packets	Displays the total number of outgoing packets received by the client.
out_octets	Displays the outgoing packets (in bytes) received by the client.

## Using the XML API Server

Follow the steps below to use the XML API:

1. Configure an XML API server.
2. Associate the XML API server to an appropriate AAA profile.
3. Configure a user role to direct non-authenticated users to the external captive portal server.
4. Configure captive portal profile and associate that to an initial role (example **logon**).
5. Create an XML request with the appropriate API call.
6. Process XML response appropriately.




---

The default logon role of a client or user must have captive-portal enabled.

---

## Configuring the XML API Server

Configure an external XML API server in your AAA infrastructure. In this example, 10.11.12.13 is your server. The XML API interface on Mobility Master will receive requests from this server.

Define the XML API server and specify the key for verifying requests from your server:

```
(host) [mynode] (config) #aaa xml-api server 10.11.12.13
(host) ^[mynode] (XML API Server "10.11.12.13") #key aruba123
(host) ^[mynode] (XML API Server "10.11.12.13") #write memory
```

Verify the XML API server configuration:

```
(host) [mynode] #show aaa xml-api server
```

```
XML API Server List
-----
Name           References  Profile Status
----           -
10.11.12.13    0
Total:1
```

## Associating the XML API Server to a AAA profile

After you define the XML API server profile associate it to the appropriate AAA profile. If the XML API server is not correctly configured in the appropriate profile, Mobility Master will respond with the **client not authorized** error message. You can add XML API server references to the following AAA profile depending on your requirement:

Create a AAA profile for the wireless users and associate the XML API server:

```
(host) [mynode] (config) #aaa profile wirelessusers
(host) ^[mynode] (AAA Profile "wirelessusers") #xml-api-server 10.11.12.13
(host) ^[mynode] (AAA Profile "wirelessusers") #write memory
```

Verify the association of the XML API server to the AAA profile:

```
(host) [mynode] #show aaa profile wirelessusers
```

```
AAA Profile "wirelessusers"
```

```
-----  
Parameter                               Value      Set  
-----  
Initial role                             logon  
MAC Authentication Profile                N/A  
MAC Authentication Default Role          guest  
MAC Authentication Server Group          default  
802.1X Authentication Profile            N/A  
802.1X Authentication Default Role       guest  
802.1X Authentication Server Group       N/A  
Download Role from CPPM                  Disabled  
Set username from dhcp option 12         Disabled  
L2 Authentication Fail Through           Disabled  
Multiple Server Accounting                Disabled  
User idle timeout                         N/A  
Max IPv4 for wireless user                2  
RADIUS Accounting Server Group            N/A  
RADIUS Interim Accounting                 Disabled  
XML API server                          10.11.12.13  
RFC 3576 server                           N/A  
User derivation rules                     N/A  
Wired to Wireless Roaming                 Enabled  
Device Type Classification                Enabled  
Enforce DHCP                              Disabled  
PAN Firewall Integration                   Disabled  
Open SSID radius accounting                Disabled
```

For wireless users, associate the AAA profile to the virtual AP profile:

```
(host) [mynode] (config) #wlan virtual-ap wireless-vap  
(host) ^[mynode] (Virtual AP profile "wireless-vap") #aaa-profile wirelessusers  
(host) ^[mynode] (Virtual AP profile "wireless-vap") #write memory
```

Verify the association of the AAA profile to the virtual AP profile:

```
(host) [mynode] #show wlan virtual-ap wireless-vap
```

```
Virtual AP profile "wireless-vap"
```

```
-----  
Parameter                               Value      Set  
-----  
AAA Profile                             wirelessusers  
802.11K Profile                           default  
Hotspot 2.0 Profile                       N/A  
Virtual AP enable                          Enabled  
VLAN                                        N/A  
Forward mode                              tunnel  
SSID Profile                              default  
Allowed band                              all  
Band Steering                             Disabled  
Cellular handoff assist                   Disabled  
Openflow Enable                           Disabled  
Steering Mode                             prefer-5ghz  
Dynamic Multicast Optimization (DMO)       Disabled  
Dynamic Multicast Optimization (DMO) Threshold 6  
Drop Broadcast and Multicast               Disabled  
Convert Broadcast ARP requests to unicast  Enabled  
Authentication Failure Blacklist Time      3600 sec  
Blacklist Time                            3600 sec  
Deny inter user traffic                   Disabled  
Deny time range                           N/A
```



```

DoS Prevention                Disabled
HA Discovery on-association    Enabled
Mobile IP                     Enabled
Preserve Client VLAN          Disabled
Remote-AP Operation           standard
Station Blacklisting          Enabled
Strict Compliance              Disabled
VLAN Mobility                  Disabled
WAN Operation mode            always
FDB Update on Assoc           Disabled
WMM Traffic Management Profile N/A
Anyspot profile                N/A

```

Create a AAA profile for the wired users and associate the XML API server:

```

(host) [mynode] (config) #aaa profile wiredusers
(host) ^[mynode] (AAA Profile "wiredusers") #xml-api-server 10.11.12.13
(host) ^[mynode] (AAA Profile "wiredusers") #write memory

```

Associate the wired AAA profile to the wired authentication profile:

```

(host) [mynode] (config) #aaa authentication wired
(host) ^[mynode] (Wired Authentication Profile) #profile wiredusers
(host) ^[mynode] (Wired Authentication Profile) #write memory

```

Verify the association of the wired AAA profile to the wired authentication profile:

```

(host) [mynode] #show aaa authentication wired

```

```

Wired Authentication Profile
-----
Parameter      Value
-----
AAA Profile    wiredusers

```

For unknown wired users, associate the XML API server to the **default-xml-api** AAA profile.




---

The **default-xml-api** AAA profile is used only to add or authenticate new users.

---

Associate the XML API server to the **default-xml-api** AAA profile:

```

(host) [mynode] (config) #aaa profile default-xml-api
(host) ^[mynode] (AAA Profile "default-xml-api") #xml-api-server 10.11.12.13
(host) ^[mynode] (AAA Profile "default-xml-api") #write memory

```

Verify the association of the XML API server to the **default-xml-api** AAA profile:

```

(host) [mynode] #show aaa profile default-xml-api

```

```

AAA Profile "default-xml-api" (Predefined (changed))
-----
Parameter                                     Value      Set
-----
Initial role                                  logon
MAC Authentication Profile                    N/A
MAC Authentication Default Role               guest
MAC Authentication Server Group              default
802.1X Authentication Profile                 N/A
802.1X Authentication Default Role           guest
802.1X Authentication Server Group           N/A
Download Role from CPPM                       Disabled
Set username from dhcp option 12             Disabled
L2 Authentication Fail Through                Disabled
Multiple Server Accounting                    Disabled
User idle timeout                             N/A

```

Max IPv4 for wireless user	2
RADIUS Accounting Server Group	N/A
RADIUS Interim Accounting	Disabled
<b>XML API server</b>	<b>10.11.12.13</b>
RFC 3576 server	N/A
User derivation rules	N/A
Wired to Wireless Roaming	Enabled
Device Type Classification	Enabled
Enforce DHCP	Disabled
PAN Firewall Integration	Disabled
Open SSID radius accounting	Disabled

Your Mobility Master is now ready to receive API calls from the XML API server.

## Setting up the Captive Portal Profile

Set up a Captive Portal profile with a login page that will redirect users to the external Captive Portal server:

```
(host) [mynode] (config) #aaa authentication captive-portal captive-portal-auth
(host) ^[mynode] (Captive Portal Authentication Profile "captive-portal-auth") #default-role
authenticated
(host) (Captive Portal Authentication Profile "captive-portal-auth") #login-page
https://10.11.12.13/cgi-bin/login.pl
(host) (Captive Portal Authentication Profile "captive-portal-auth") #switch-in-redirection-
url
(host) (Captive Portal Authentication Profile "captive-portal-auth") #write memory
```




---

The *login-page https://10.11.12.13/cgi-bin/login.pl* is for illustration purposes where the *login.pl* is a Perl script on the external server that handles the external captive portal.

---

## Associating the Captive Portal Profile to an Initial Role

Associate the Captive Portal profile to the logon role:

```
(host) [mynode] (config) #user-role logon
(host) ^[mynode] (config-submode)#captive-portal captive-portal-auth
(host) ^[mynode] (config-submode)#session-acl captiveportal
(host) ^[mynode] (config-submode)#write memory
```

Create an alias for the external Captive Portal server:

```
(host) [mynode] (config) #netdestination xCP
(host) ^[mynode] (config-submode)#host 10.11.12.13
(host) ^[mynode] (config-submode)#write memory
```

You can either create a new ACL or append specific rules to an existing ACLs. Create session ACL for the logon role:

```
(host) [mynode] (config) #ip access-list session captiveportal
(host) ^[mynode] (config-submode)#user alias xCP svc-https permit
(host) ^[mynode] (config-submode)#user alias xCP svc-http permit
(host) ^[mynode] (config-submode)#write memory
```

## Creating an XML API Request

You can now create an XML request with an XML API command and send it to Mobility Master via HTTPS POST. The format of the URL to send the XML request is:

```
https://<Mobility Master-ip/auth/command.xml
```

- **Mobility Master-ip:** The IP address of Mobility Master that will receive the XML API request
- **command.xml:** The XML request that contains the XML API command.

The format of the XML API request is:

```
xml=<aruba command="<XML API command">
  <options>Value</options>
  ...
  <options>Value</options>
</aruba>
```

You can specify any of the following commands in the XML request:

**Table 236:** XML API Command

XML API Command	Description
user_add	This command creates a new user entry in the Mobility Master user table. If the user entry is already present in the user table, the command will modify the entry with the values defined in the XML request. For an existing user, this command will update any value that is supplied, with an exception of IP and MAC address. Session time-out is only applicable to captive portal users.
user_delete	This command deletes an existing user from the Mobility Master user table.  <b>NOTE:</b> Do not use the <b>user_delete</b> command if the intention is to clear the association from the Mobility Master user table. If the client is dual-stack, it re-inherits the authentication state from the IPv6 address. If not dual-stack, the client reverts to the initial role.
user_authenticate	This command authenticates against the server group defined in the captive portal profile. This is only applicable to captive portal users.
user_blacklist	This command blacklists a user from connecting to your network. This command uses the default blacklist timeout of 3600 seconds. There is no corresponding <b>clear</b> command. You can use the Mobility Master CLI to clear the blacklisted clients. Refer the <b>show ap blacklist-clients</b> , <b>stm remove-blacklist-client</b> , and <b>stm purge-blacklist-clients</b> commands in the <i>ArubaOS CLI Reference Guide</i> to clear the blacklisted clients.
user_query	This command fetches the status and details of a user connected to your network. A dual-stack client can be queried by any of its IPv4 or IPv6 addresses, but only the queried IP address is displayed in the output.
user_logout	This command reverts the user to the initial role. This is only applicable to captive portal users. For dual-stack clients, all user-table entries will be reverted to the initial role.

Each XML API command requires certain mandatory options to successfully execute the task. The list of all available options are:

**Table 237: XML API Command Options**

Options	Description	Range / Defaults
ipaddr	IP address of the user in IPv4 or IPv6 format.	—
macaddr	MAC address of the user in aa:bb:cc:dd:ee:ff format.	Enter MAC address with colon.
user	Name of the user.	64 character string
role	The role to apply to a newly created user, or change of role for an existing user. This option applies to <b>user_add</b> and <b>user_delete</b> commands only.	64 character string
password	The password of the user for authentication.	—
session_timeout	Session time-out in seconds. User will be disconnected after this time.	—
authentication	Authentication method used to authenticate the message and the sender. You can use any of MD5, SHA-1 or clear text methods of authentication. This option is ignored if shared secret is not configured. It is, however, mandatory if it is configured.	—
key	This is the encoded SHA1/MD5 hash of shared secret or plaintext shared secret.  This option is ignored if shared secret is not configured on the switch.  The actual MD5/SHA-1 hash is 16/20 bytes and consists of binary data. It must be encoded as an ASCII based HEX string before sending. It must be present when the Mobility Master is configured with an xml-api key for the server. Encoded hash length is 32/40 bytes for MD5/SHA-1.	
version	The version of the XML API interface available in Mobility Master. This field is mandatory in all XML API requests.	Current version 1.0

## Monitoring External Captive Portal Usage Statistics

To check the external captive portal authentication statistics, execute the **show aaa xml-api statistics** command. This command displays the number of times an authentication command was executed per client. The command also displays the number of times an authentication event occurred and the number of new authentication events that occurred since the last status check.

```
(host) [mynode] #show aaa xml-api statistics
```

## Sample Scripts

You can download the sample scripts from [support.arubanetworks.com](http://support.arubanetworks.com). Before downloading the scripts, you must read the following disclaimer.



---

The sample scripts are examples and provided for illustration purposes only. If you plan to use this script in your environment, ensure that the script meets your IT guidelines. By running this script, you acknowledge that Aruba, a Hewlett Packard Enterprise company is in no way liable for any loss, damage, problems arising from running this script.

---

The following scripts are available for download:

### Python 2.7 Script

- *ArubaXMLDemo.py*: This is a Python 2.7 script. This script demonstrates the basic functionality of the XML API. Using this script, you can send XML requests to add, delete, authenticate, blacklist, query, or log out a user.

### Bourne Shell Scripts

- *xml\_user\_add.sh*: This script adds a user using the **user\_add** command.
- *xml\_user\_del\_or\_logout.sh*: The **user\_delete** part of the script deletes an existing user from the Mobility Master user table. The **user\_logout** part of the script reverts an existing user to the initial role in the AAA profile.
- *xml\_user\_query.sh*: This script fetches the status and details of a user connected in the network using the **user\_query** command.



---

The Bourne Shell scripts work on most Unix, Linux, and Mac operating systems. To run on Windows, you can install Cygwin.

---



---

All scripts require cURL to be installed on the XML API server. cURL is an open source command line tool and library for transferring data with URL syntax. You can download cURL from <http://curl.haxx.se/download.html>.

---

## XML API using Python 2.7

The information covered in the following section is based on running the *ArubaXMLDemo.py* script on a Windows 8.1 64-bit and Python 2.7.

### Understanding Request and Response

Mobility Master processes the XML API request and sends the response to the XML API server. The XML response contains the status of the request and a code in case of an error.

Request format: **<script\_name> <Mobility Master-ip> <secret\_key> <command> [options]**

### Understanding XML API Request Parameters

The [Table 238](#) lists all parameters that you can use in a request.

**Table 238:** XML API Request Parameters and Descriptions

Parameter	Description
script_name	The name of the script executable.
Mobility Master-ip	The IP address of Mobility Master that will receive the XML requests.
secret_key	The password used to validate the authentication request from your authentication server. See <a href="#">Configuring the XML API Server on page 1031</a> for more information.

Parameter	Description
command	<p>The XML API command sent to the Mobility Master. You can send one of the following commands per request:</p> <ul style="list-style-type: none"> <li>• <b>use_add</b>: Creates a new user entry in the Mobility Master user table. If the user entry is already present in the user table, the command will modify the entry with the values defined in the XML request. For an existing user, this command will update any value that is supplied, with an exception of IP and MAC address. Session time-out is only applicable to captive portal users.</li> <li>• <b>user_delete</b>: Deletes an existing user from the Mobility Master user table.</li> </ul> <p><b>NOTE:</b> Do not use the <b>user_delete</b> command if the intention is to clear the association from the Mobility Master user table. If the client is dual-stack, it re-inherits the authentication state from the IPv6 address. If not dual-stack, the client reverts to the initial role.</p> <ul style="list-style-type: none"> <li>• <b>user_authenticate</b>: Authenticates against the server group defined in the captive portal profile. This is only applicable to captive portal users.</li> <li>• <b>user_blacklist</b>: Blacklists a user from connecting to your network. This command uses the default blacklist timeout of 3600 seconds. There is no corresponding <b>clear</b> command. You can use the Mobility Master CLI to clear the blacklisted clients. Refer the <b>show ap blacklist-clients</b>, <b>stm remove-blacklist-client</b>, and <b>stm purge-blacklist-clients</b> commands in the <i>ArubaOS CLI Reference Guide</i> to clear the blacklisted clients.</li> <li>• <b>user_query</b>: Fetches the status and details of a user connected to your network. A dual-stack client can be queried by any of its IPv4 or IPv6 addresses, but only the queried IP address is displayed in the output.</li> <li>• <b>user_logout</b>: Reverts the user to the initial role. This is only applicable to captive portal users. For dual-stack clients, all user-table entries will be reverted to the initial role.</li> </ul>
Options	<ul style="list-style-type: none"> <li>• <b>-i &lt;ip_addr&gt;</b>: Specify the IP address of the user in IPv4 or IPv6 format.</li> <li>• <b>-m &lt;mac_addr&gt;</b>: Specify the MAC address of the user in aa:bb:cc:dd:ee:ff format.</li> <li>• <b>-n &lt;name&gt;</b>: Specify the name of the user.</li> <li>• <b>-p &lt;password&gt;</b>: Specify the password of the user for authentication.</li> <li>• <b>-r role</b>: Specify the role to apply to a newly created user, or change of role for an existing user. This option applies to <b>user_add</b> and <b>user_delete</b> commands only.</li> <li>• <b>-t timeout</b>: Specifies the session time-out in seconds. User will be disconnected after this time.</li> <li>• <b>-v version</b>: Specifies the version of the XML API interface available in Mobility Master. This field is mandatory in all requests. Default version is 1.0.</li> <li>• <b>-a method</b>: Specifies the encryption method to send the secret key. You can specify MD5 or SHA-1 or cleartext as the encryption method. By default, cleartext method is used to send the key.</li> <li>• <b>-s sessid</b>: Specifies the active session ID.</li> </ul>

## Understanding an XML API Response

The response message from Mobility Master is sent in an XML format. The default format of the response is:

```
[Message header]
Displays the request parameters and other standard header details.
...
...
...
<response>
```

```

    <status>Status Message</status>
    <code>Code in case of an error</code>
</response>

```

The following section describes few of the XML API requests and responses from Mobility Master.

## Adding a User

This XML request uses the **user\_add** command to create a new user entry in the Mobility Master user table.

```
C:\Python27>python ArubaXMLDemo.py --switch-ip=192.0.2.1 --secret=aruba123 --command=user_add
--ip=192.0.2.2 --mac=a4:e:60:c3:10:59 --role=logon
```

The command sends the following information in the XML request to Mobility Master:

- **--switch-ip:** IP address of Mobility Master
- **--secret:** Shared secret key (sent as plain text)
- **--command:** XML API command
- **--ip:** IP address of the user
- **--mac:** MAC address of the user
- **--role:** User role

## Mobility Master Response

Mobility Master processes using an XML format and sends the following response to the XML API server.

Warning: The specified mac address *\*must\** match the user specified by --ip or the command will fail.

```

Prepared XML buf
-----
xml=<aruba command="user_add">
<ipaddr>192.0.2.2</ipaddr>
<macaddr>a4:5e:60:c3:10:59</macaddr>
<role>logon</role>
<authentication>cleartext</authentication>
<key>aruba123</key>
<version>1.0</version>
</aruba>
-----
Sending XML request to https://192.0.2.1/auth/command.xml
Controller response status: 200
Response XML
-----
<aruba>
<status>Ok</status>
<code>0</code>
</aruba>
-----

```

## Mobility Master CLI

You can view the updated details of the user in the Mobility Master CLI.

```
(host) [mynode] #show user-table
```

Users

```

-----
IP             MAC             Name           Role   Age (d:h:m)  Auth  VPN link  AP name
-----
192.0.2.2     a4:5e:60:c3:10:59  logon         logon  00:00:00

```

```

Roaming  Essid/Bssid/Phy  Profile  Forward mode  Type  Host Name
-----

```



User Entries: 1/1

## Querying a User

This XML request uses the **user\_query** command to get the status and details of a user connected to your network.

```
C:\Python27>python ArubaXMLDemo.py --switch-ip=192.0.2.1 --secret=aruba123 --command=user_query --ip=192.0.2.2
```

The command sends the following information in the XML request to Mobility Master:

- **--switch-ip:** IP address of Mobility Master
- **--secret:** Shared secret key (sent as plain text)
- **--command:** XML API command
- **--ip:** IP address of the user

## Mobility Master Response

Mobility Master processes using an XML format and sends the following response to the XML API server.

Prepared XML buf

```
-----  
xml=<aruba command="user_query">  
<ipaddr>192.0.2.2</ipaddr>  
<authentication>cleartext</authentication>  
<key>aruba123</key>  
<version>1.0</version>  
</aruba>  
-----
```

Sending XML request to https://192.0.2.1/auth/command.xml

Controller response status: 200

Response XML

```
-----  
<aruba>  
  <status>Ok</status>  
  <code>0</code>  
  <macaddr>a4:5e:60:c3:10:59</macaddr>  
  <ipaddr>192.0.2.2</ipaddr>  
  <name>John</name>  
  <role>authenticated</role>  
  <type>Wireless</type>  
  <vlan>1034</vlan>  
  <location>ap225-sales</location>  
  <age>00:03:51</age>  
  <auth_status>Authenticated</auth_status>  
  <auth_server>clearpass-hq1</auth_server>  
  <auth_method>802.1X</auth_method>  
  <ssid>ethersphere-wpa2</ssid>  
  <bssid>9c:1c:12:92:2e:f1</bssid>  
  <phy_type>a-VHT-80</phy_type>  
  <mobility_state>Wireless</mobility_state>  
  <in_packets>93400</in_packets>  
  <in_octets>24947332</in_octets>  
  <out_packets>89042</out_packets>  
  <out_octets>79397284</out_octets>  
</aruba>  
-----
```

## Mobility Master CLI

The output of the **show user** command displays the client information.

```
(host) #show user
```

```
Users
```

```
-----
```

IP	MAC	Name	Role	Age (d:h:m)	Auth	VPN link
192.0.2.2	a4:5e:60:c3:10:59	John	authenticate	00:03:51	Authenticated	

AP name	Roaming	Essid/Bssid/Phy	Profile	Forward mode
ap225-sales	Wireless	ethersphere-wpa2/9c:1c:12:92:2e:f1/a-VHT-80		

```
Type Host Name
```

```
-----
```

```
User Entries: 1/1
```

## Logging Out a User

This XML request uses the **user\_logout** command to revert the user to the initial role. This is only applicable to captive portal users.

```
C:\Python27>python ArubaXMLDemo.py --switch-ip=192.0.2.1 --secret=aruba123 --command=user_logout --ip=192.0.2.2
```

The command sends the following information in the XML request to Mobility Master:

- **--switch-ip:** IP address of Mobility Master
- **--secret:** Shared secret key (sent as plain text)
- **--command:** XML API command
- **--ip:** IP address of the user

## Mobility Master Response

Mobility Master processes using an XML format and sends the following response to the XML API server.

```
Prepared XML buf
```

```
-----  
xml=<aruba command="user_logout">  
<ipaddr>192.0.2.2</ipaddr>  
<authentication>cleartext</authentication>  
<key>aruba123</key>  
<version>1.0</version>  
</aruba>  
-----
```

```
Sending XML request to https://192.0.2.1/auth/command.xml
```

```
Controller response status: 200
```

```
Response XML
```

```
-----
```

```
<aruba>  
  <status>Ok</status>  
  <code>0</code>  
</aruba>
```

## Mobility Master CLI

The output of the **show user** command displays the client information.

```
(host) #show user
```

```
Users
```

```
-----
```

IP	MAC	Name	Role	Age (d:h:m)	Auth	VPN link
----	-----	------	------	-------------	------	----------

```
-----
```

192.0.2.2    a4:5e:60:c3:10:59    John    initial    00:00:06    Unauthenticated

AP name	Roaming	Essid/Bssid/Phy	Profile	Forward mode
ap225-sales	Wireless	ethersphere-wpa2/9c:1c:12:92:2e:f1/a-VHT-80		

Type	Host Name
----	-----

User Entries: 1/1

Topics in this chapter include:

- [Understanding Mode Support on page 1044](#)
- [Understanding Basic System Defaults on page 1046](#)
- [Understanding Default Management User Roles on page 1054](#)
- [Understanding Default Open Ports on page 1055](#)

### Understanding Mode Support

Most ArubaOS features are supported in all forwarding modes. However, there are a some features that are not supported in one or more forwarding modes. Campus APs do not support split-tunnel forwarding mode and the decrypt-tunnel forwarding mode does not support TKIP Counter measure management on campus APs or remote APs.

[Table 239](#) describes the features that are not supported in each forwarding mode.

**Table 239:** Features not Supported in Each Forwarding Mode

Forwarding Mode	Feature Not Supported
Split Tunnel Mode on Remote APs	<ul style="list-style-type: none"> <li>Bandwidth based CAC</li> <li>Dynamic Multicast Optimization</li> <li>IGMP Proxy Mobility</li> <li>Layer-2 Mobility</li> <li>Layer-3 Mobility</li> <li>Mobile IP</li> <li>Named VLAN</li> <li>TKIP countermeasure management</li> <li>Video over Mesh</li> <li>VLAN pooling</li> <li>Voice over Mesh</li> </ul>
Bridge Mode on Campus APs or Remote APs	<ul style="list-style-type: none"> <li>AirGroup</li> <li>AppRF</li> <li>Automatic Voice Flow Classification</li> <li>Bandwidth based CAC</li> <li>Broadcast filter</li> <li>Captive Portal</li> <li>DHCP enforcement</li> <li>DHCP fingerprint</li> <li>Dynamic Multicast Optimization</li> <li>Firewall – Alcatel NOE Support</li> <li>Firewall – SIP / SCCP / RTP / RTSP Voice Support</li> <li>H.323 ALG</li> <li>IGMP Proxy Mobility</li> <li>Layer 3 Mobility</li> <li>Lync SDN API</li> <li>Management: Voice client statistics</li> <li>Management: Voice client troubleshooting</li> <li>Management: Voice-specific views</li> <li>Mobile IP</li> <li>Named VLAN</li> <li>NOE ALG</li> <li>Power save: Drop wireless multicast traffic</li> <li>Power save: Proxy ARP (global)</li> <li>Power save: Proxy ARP (per-SSID)</li> </ul>

Forwarding Mode	Feature Not Supported
	Power save: Wireless battery boost RADIUS CoA Rate Limiting for broadcast / multicast SCCP ALG SIP ALG SIP: CAC enforcement enhancements SIP: Delay measurement SIP: Phone number awareness SIP: R-Value computation SIP: SIP authentication tracking Station blacklist Station blacklist by an ACL action SVP ALG TKIP countermeasure management Video over Mesh Vocera ALG Voice over Mesh Voice protocol monitoring / reporting WebCC XML-API

## Understanding Basic System Defaults

The default administrator user name is **admin**, and the password should be set up during the initial setup dialog. The ArubaOS software includes several predefined network services, firewall policies, and roles.

### Network Services

The following table lists the predefined network services and their protocols and ports.

**Table 240:** *Predefined Network Services*

Name	Protocol	Port(s)
svc-dhcp	udp	67 68
svc-snmp-trap	udp	162
svc-smb-tcp	tcp	445
svc-https	tcp	443
svc-ike	udp	500

Name	Protocol	Port(s)
svc-l2tp	udp	1701
svc-syslog	udp	514
svc-pptp	tcp	1723
svc-telnet	tcp	23
svc-sccp	tcp	2000
svc-tftp	udp	69
svc-sip-tcp	tcp	5060
svc-kerberos	udp	88
svc-pop3	tcp	110
svc-adp	udp	8200
svc-noe	udp	32512
svc-noe-oxo	udp	5000
svc-dns	udp	53
svc-msrpc-tcp	tcp	135 139
svc-rtsp	tcp	554
svc-http	tcp	80
svc-vocera	udp	5002
svc-nterm	tcp	1026 1028
svc-sip-udp	udp	5060
svc-papi	udp	8211
svc-ftp	tcp	21
svc-natt	udp	4500

Name	Protocol	Port(s)
svc-svp	119	0
svc-gre	gre	0
svc-smtp	tcp	25
svc-smb-udp	udp	445
svc-esp	esp	0
svc-bootp	udp	67 69
svc-snmp	udp	161
svc-icmp	icmp	0
svc-ntp	udp	123
svc-msrpc-udp	udp	135 139
svc-ssh	tcp	22
svc-h323-tcp	tcp	1720
svc-h323-udp	udp	1718 1719
svc-http-proxy1	tcp	3128
svc-http-proxy2	tcp	8080
svc-http-proxy3	tcp	8888
svc-sips	tcp	5061
svc-v6-dhcp	udp	546 547
svc-v6-icmp	icmp	0
any	any	0

## Policies

The following table lists predefined policies.



**Table 241: Predefined Policies**

Predefined Policy	Description
<pre>ip access-list session allowall any any any permit</pre>	<p>An "allow all" firewall rule that permits all traffic.</p>
<pre>ip access-list session control user any udp 68 deny any any svc-icmp permit any any svc-dns permit any any svc-papi permit any any svc-cfgm-tcp permit any any svc-adp permit any any svc-tftp permit any any svc-dhcp permit any any svc-natt permit</pre>	<p>Controls traffic - Apply to untrusted wired ports in order to allow Aruba APs to boot up.</p> <p><b>NOTE:</b> In most cases wired ports should be made "trusted" when attached to an internal network.</p>
<pre>ip access-list session captiveportal user alias mswitch svc-https dst-nat 8081 user any svc-http dst-nat 8080 user any svc-https dst-nat 8081 user any svc-http-proxy1 dst-nat 8088 user any svc-proxy2 dst-nat 8088 user any svc-http-proxy3 dst-nat 8088</pre>	<p>Enables captive portal authentication.</p> <ol style="list-style-type: none"> <li>Any HTTPS traffic destined for the managed device will be NATed to port 8081, where the captive portal server will answer.</li> <li>All HTTP traffic to any destination will be NATed to the managed device on port 8080, where an HTTP redirect will be issued.</li> <li>All HTTPS traffic to any destination will be NATed to the managed device on port 8081, where an HTTP redirect will be issued.</li> <li>All HTTP proxy traffic will be NATed to the managed device on port 8088.</li> </ol> <p><b>NOTE:</b> In order for captive portal to work properly, DNS must also be permitted. This is normally done in the "logon-control" firewall rule.</p>
<pre>ip access-list session cplogout user alias mswitch svc-https dst-nat 8081</pre>	<p>Used to enable the captive portal "logout" window. If the user attempts to connect to the managed device on the standard HTTPS port (443) the client will be NATed to port 8081, where the captive portal server will answer. If this rule is not present, a wireless client may be able to access the managed device's administrative interface.</p>
<pre>ip access-list session vpnlogon any any svc-ike permit any any svc-esp permit any any svc-l2tp permit any any svc-pptp permit any any svc-gre permit</pre>	<p>This policy permits VPN sessions to be established to any destination. IPsec (IKE, ESP, and L2TP) and PPTP (PPTP and GRE) are supported.</p>
<pre>ip access-list session ap-acl any any udp 5000 5555 any any svc-gre permit any any svc-syslog permit any user svc-snmp permit user any svc-snmp-trap permit user any svc-ntp permit</pre>	<p>This is a policy for internal use and should not be modified. It permits APs to boot up and communicate with the managed device.</p>

Predefined Policy	Description
<pre>ip access-list session validuser any any any permit</pre>	<p>This firewall rule controls which users will be added to the user table of the managed device through untrusted interfaces. Only IP addresses permitted by this ACL will be admitted to the system for further processing. If a client device attempts to use an IP address that is denied by this rule, the client device will be ignored by the managed device and given no network access. You can use this rule to restrict foreign IP addresses from being added to the user-table.</p> <p>This policy should not be applied to any user role, it is an internal system policy.</p>
<pre>ip access-list session vocera-acl any any svc-vocera permit queue high</pre>	Use for Vocera VoIP devices to automatically permit and prioritize Vocera traffic.
<pre>ip access-list session icmp-acl any any svc-icmp permit</pre>	Permits all ICMP traffic.
<pre>ip access-list session sip-acl any any svc-sip-udp permit queue high any any svc-sip-tcp permit queue high</pre>	Use for SIP VoIP devices to automatically permit and prioritize all SIP control and data traffic.
<pre>ip access-list session https-acl any any svc-https permit</pre>	Permits all HTTPS traffic.
<pre>ip access-list session dns-acl any any svc-dns permit</pre>	Permits all DNS traffic.
<pre>ip access-list session logon-control user any udp 68 deny any any svc-icmp permit any any svc-dns permit any any svc-dhcp permit any any svc-natt permit</pre>	The default pre-authentication role that should be used by all wireless clients. Prohibits the client from acting as a DHCP server. Permits all ICMP, DNS, and DHCP. Also permits IPsec NAT-T (UDP 4500). Remove NAT-T if not needed.
<pre>ip access-list session srcnat user any any src-nat</pre>	This policy can be used to source-NAT all traffic. Because no NAT pool is specified, traffic that matches this policy will be source NATed to the IP address of the managed device.
<pre>ip access-list session skinny-acl any any svc-sccp permit queue high</pre>	Use for Cisco Skinny VoIP devices to automatically permit and prioritize VoIP traffic.
<pre>ip access-list session tftp-acl any any svc-tftp permit</pre>	Permits all TFTP traffic.
<pre>ip access-list session guest</pre>	This policy is not used.
<pre>ip access-list session dhcp-acl any any svc-dhcp permit</pre>	Permits all DHCP traffic. If DHCP is not allowed, clients will not be able to request or renew IP addresses.

Predefined Policy	Description
<code>ip access-list session http-acl any any svc-http permit</code>	Permits all HTTP traffic.
<code>ip access-list session svp-acl any any svc-svp permit queue high user host 224.0.1.116 any permit</code>	Use for Spectralink VoIP devices to automatically permit and prioritize Spectralink Voice Protocol (SVP).
<code>ip access-list session noe-acl any any svc-noe permit queue high</code>	Use for Alcatel NOE VoIP devices to automatically permit and prioritize NOE traffic.
<code>ip access-list session h323-acl any any svc-h323-tcp permit queue high any any svc-h323-udp permit queue high</code>	Use for H.323 VoIP devices to automatically permit and prioritize H.323 traffic.
<code>ipv6 access-list session v6-control user any udp 68 deny any any svc-v6-icmp permit any any svc-v6-dhcp permit any any svc-dns permit any any svc-tftp permit</code>	Provides equivalent functionality to the "control" policy, but for IPv6 clients.
<code>ipv6 access-list session v6-icmp-acl any any svc-v6-icmp permit</code>	Permits all ICMPv6 traffic.
<code>ipv6 access-list session v6-https-acl any any svc-https permit</code>	Permits all IPv6 HTTPS traffic.
<code>ipv6 access-list session v6-dhcp-acl any any svc-v6-dhcp permit</code>	Permits all IPv6 DHCP traffic.
<code>ipv6 access-list session v6-dns-acl any any svc-dns permit</code>	Permits all IPv6 DNS traffic.
<code>ipv6 access-list session v6-allowall any any any permit</code>	Permits all IPv6 traffic.
<code>ipv6 access-list session v6-http-acl any any svc-http permit</code>	Permits all IPv6 HTTP traffic.
<code>ipv6 access-list session v6-tftp-acl any any svc-tftp permit</code>	Permits all IPv6 TFTP traffic.
<code>ipv6 access-list session v6-logon-control user any udp 68 deny any any svc-v6-icmp permit any any svc-v6-dhcp permit any any svc-dns permit</code>	Provides equivalent functionality to the "logon-control" policy, but for IPv6 clients.

## Validuser and Logon-control ACLs

Default firewall rules for both the validuser and logon-control ACLs prevent malicious users by blocking self-assigned IPs.

A client with the correct source address can send traffic to the below networks as a destination IP address. The default firewall rules deny traffic FROM the reserved addresses.

The following networks can be blocked by the default firewall rules in both the validuser and logon-control ACLs:

- Network packets where the source address of the network packet is defined as being on a broadcast network (source address == 255.255.255.255)
- Network packets where the source address of the network packet is defined as being on a multicast network (source address = 224.0.0.0 – 239.255.255.255)
- Network packets where the source address of the network packet is defined as being a loopback address (127.0.0.1 through 127.255.255.254)
- Network packets where the source or destination address of the network packet is a link-local address (169.254.0.0/16)
- Network packets where the source or destination address of the network packet is defined as being an address “reserved for future use” as specified in RFC 5735 for IPv4; (240.0.0.0/4)
- Network packets where the source or destination address of the network packet is defined as an “unspecified address”(::firewall enable-per-packet-logging configuration.

## Roles

The following table lists predefined roles.



If you upgrade from a previous ArubaOS release, your existing configuration may have additional or different predefined roles. The information in this section only describes the predefined roles for this release.

**Table 242: Predefined Roles**

Predefined Role	Description
<pre>user-role ap-role   session-acl control   session-acl ap-acl</pre>	This is an internal role and should not be edited.
<pre>user-role default-vpn-role   session-acl allowall   ipv6 session-acl v6-allowall</pre>	This is the default role used for VPN-connected clients. It is referenced in the default "aaa authentication vpn" profile.
<pre>user-role voice   session-acl sip-acl   session-acl noe-acl   session-acl svp-acl   session-acl vocera-acl   session-acl skinny-acl   session-acl h323-acl   session-acl dhcp-acl   session-acl tftp-acl   session-acl dns-acl   session-acl icmp-acl</pre>	This role can be applied to voice devices in order to automatically permit and prioritize all VoIP protocols.
<pre>user-role guest   session-acl http-acl   session-acl https-acl   session-acl dhcp-acl   session-acl icmp-acl   session-acl dns-acl   ipv6 session-acl v6-http-acl   ipv6 session-acl v6-https-acl</pre>	This is a default role for guest users. It permits only HTTP, HTTPS, DHCP, ICMP, and DNS for the guest user. To increase security, a "deny" rule for internal network destinations could be added at the beginning.

Predefined Role	Description
<pre> ipv6 session-acl v6-dhcp-acl ipv6 session-acl v6-icmp-acl ipv6 session-acl v6-dns-acl </pre>	
<pre> user-role guest-logon captive-portal default session-acl logon-control session-acl captiveportal </pre>	<p>This role is used as the pre-authentication role for guest SSIDs. It allows control traffic such as DNS, DHCP, and ICMP, and also enables captive portal.</p>
<pre> user-role &lt;ssid&gt;-guest-logon captive-portal default session-acl logon-control session-acl captiveportal </pre>	<p>This role is only generated when creating a new WLAN using the WLAN Wizard. The WLAN Wizard creates this role when captive portal is enabled. This is the initial role that a guest will be placed in prior to captive portal authentication. By using a different guest logon role for each SSID, it is possible to enable multiple captive portal profiles with different customization.</p>
<pre> user-role stateful-dot1x </pre>	<p>This is an internal role used for Stateful 802.1X. It should not be edited.</p>
<pre> user-role authenticated session-acl allowall ipv6 session-acl v6-allowall </pre>	<p>This is a default role that can be used for authenticated users. It permits all IPv4 and IPv6 traffic for users who are part of this role.</p>
<pre> user-role logon session-acl logon-control session-acl captiveportal session-acl vpnlogon ipv6 session-acl v6-logon-control </pre>	<p>This is a system role that is normally applied to a user prior to authentication. This applies to wired users and non-802.1X wireless users.</p> <p>The role allows certain control protocols such as DNS, DHCP, and ICMP, and also enables captive portal and VPN termination/pass through. The logon role should be edited to provide only the required services to a pre-authenticated user. For example, VPN pass through should be disabled if it is not needed.</p>
<pre> user-role &lt;ssid&gt;-logon session-acl control session-acl captiveportal session-acl vpnlogon </pre>	<p>This role is only generated when creating a new WLAN using the WLAN wizard. The WLAN wizard creates this role when captive portal is enabled and a PEFNG license is installed. This is the initial role that a client will be placed in prior to captive portal authentication. By using a different logon role for each SSID, it is possible to enable multiple captive portal profiles with different customization.</p>
<pre> user-role &lt;ssid&gt;-captiveportal-profile </pre>	<p>When utilizing the WLAN Wizard and you do not have a PEFNG installed and you are configuring an Internal or Guest WLAN with captive portal enabled, the managed device creates an implicit user role with the same name as the captive portal profile, &lt;ssid&gt;-captiveportal-profile.</p>

Predefined Role	Description
	This implicit user role allows only DNS and DHCP traffic between the client and network and directs all HTTP or HTTPS requests to the captive portal. You cannot directly modify the implicit user role or its rules. Upon authentication, captive portal clients are allowed full access to their assigned VLAN. Once the WLAN configuration is pushed to the managed device, the WLAN wizard will associate the new role with the initial user role that you specify in the AAA profile. This role will not be visible to the user in the WLAN wizard.

## Understanding Default Management User Roles

The ArubaOS software includes predefined management user roles.



If you upgrade from a previous ArubaOS release, your existing configuration may have different management roles. The information in this section only describes the predefined management roles for this release.

**Table 243: Predefined Management Roles**

Predefined Role	Permissions
ap-provisioning	This role permits access only to AP provisioning commands and no access to other configuration commands on the Mobility Master.
guest-provisioning	This role permits access to configuring guest users in the managed device's internal database only. This user only has access via the WebUI to create guest accounts; there is no CLI access.  Guest-provisioning tasks include creating or generating the user name and password for a guest account as well as configuring when the account expires.
location-api-mgmt	This role permits access to location API information and the CLI; however, you cannot use any CLI commands. This role does not permit access to the WebUI.  Using a third-party location appliance, you can gather information about the location of 802.11 stations.  To log in to the managed device using a third-party location appliance, enter:  <a href="http[s]://&lt;ipaddress&gt;[:port]/screens/wms/wms.login">http[s]://&lt;ipaddress&gt;[:port]/screens/wms/wms.login</a> .  You are prompted to enter your username and password (for example, the username and password associated with the location API management role). Once authenticated, you can use an API call to request location information from the managed device, for example:  <a href="http[s]://&lt;ipaddress&gt;[:port]/screens/wms/wms.cgi?opcode=wlm-get-spot&amp;campus-name=&lt;campus id&gt;&amp;building-name&lt;building id&gt;&amp;mac=&lt;client1&gt;,&lt;client2&gt;....">http[s]://&lt;ipaddress&gt;[:port]/screens/wms/wms.cgi?opcode=wlm-get-spot&amp;campus-name=&lt;campus id&gt;&amp;building-name&lt;building id&gt;&amp;mac=&lt;client1&gt;,&lt;client2&gt;....</a>
nbapi-mgmt	This role permits configuring a NBAPI management role.
root	This role permits access to all management functions (commands and operations) on the managed device.

Predefined Role	Permissions
read-only	This role permits access to CLI show commands or WebUI monitoring pages only.

## Understanding Default Open Ports

By default, Aruba managed devices and access points treat ports as untrusted. However, certain ports are open by default only on the trusted side of the network. These open ports are listed in [Table 244](#).

**Table 244:** *Default (Trusted) Open Ports*

Port Number	Protocol	Where Used	Description
17	TCP	managed device	This is used for certain types of VPN clients that accept a banner (QOTD). During normal operation, this port will only accept a connection and immediately close it.
21	TCP	managed device	
22	TCP	managed device	SSH
23	TCP	AP and managed device	Telnet is disabled by default but the port is still open.
53	UDP	managed device	Internal domain.
67	UDP	AP (and managed device if DHCP server is configured)	DHCP server.
68	UDP	AP (and managed device if DHCP server is configured)	DHCP client.
69	UDP	managed device	TFTP
80	TCP	AP and managed device	Used for remote packet capture where the capture is saved on the access point. Provides access to the WebUI on the managed device.
123	UDP	managed device	NTP

Port Number	Protocol	Where Used	Description
161	UDP	AP and managed device	SNMP. Disabled by default.
443	TCP	managed device	<p>Used internally for captive portal authentication (HTTPS) and is exposed to wireless users. A default self-signed certificate is installed in the managed device. Users in a production environment are urged to install a certificate from a well known CA such as Verisign. Self-signed certs are open to man-in-the-middle attacks and should only be used for testing.</p> <p><b>Required for VIA:</b> During the initializing phase, VIA uses HTTPS connections to perform trusted network and captive portal checks against the managed device. It is mandatory that you enable port 443 on your network to allow VIA to perform these checks.</p>
500	UDP	managed device	ISAKMP
514	UDP	managed device	Syslog
1701	UDP	managed device	L2TP
1723	TCP	managed device	PPTP
2300	TCP	managed device	Internal terminal server opened by <code>telnet soe</code> command.
3306	TCP	managed device	Remote wired MAC lookup.



Port Number	Protocol	Where Used	Description
4343, 443	TCP	managed device	HTTPS. Both port 4343 and 443 are supported. If port 4343 is used it redirects to port 443. If port 443 is used it continues to connect using this port. A default self-signed certificate is installed in the managed device. Users in a production environment are urged to install a certificate from a well known CA such as Verisign. Self-signed certs are open to man-in-the-middle attacks and should only be used for testing.
4500	UDP	managed device	sae-urn <b>Required for VIA:</b> During the initializing phase, VIA uses HTTPS connections to perform trusted network and captive portal checks against the managed device. It is mandatory that you enable port 4500 on your network to allow VIA to perform these checks.
8080	TCP	managed device	Used internally for captive portal authentication (HTTP-proxy). This port is not exposed to wireless users.

Port Number	Protocol	Where Used	Description
8081	TCP	managed device	Used internally for captive portal authentication (HTTPS). Not exposed to wireless users. A default self-signed certificate is installed in the managed device. Users in a production environment are urged to install a certificate from a well known CA such as Verisign. Self-signed certs are open to man-in-the-middle attacks and should only be used for testing.
8082	TCP	managed device	Used internally for single sign-on authentication (HTTP). Not exposed to wireless users.
8083	TCP	managed device	Used internally for single sign-on authentication (HTTPS). Not exposed to wireless users.
8088	TCP	managed device	For internal use.
8200	UDP	managed device	The Aruba Discovery Protocol (ADP)
8211	UDP	managed device	For internal use.
8888	TCP	managed device	Used for HTTP access.

This chapter describes how to configure several DHCP vendor-specific options.

Topics in this chapter include:

- [Configuring a Windows-Based DHCP Server on page 1059](#)
- [Enabling DHCP Relay Agent Information Option \(Option 82\) on page 1060](#)
- [Enabling Linux DHCP Servers on page 1061](#)

## Configuring a Windows-Based DHCP Server

Configuring a Microsoft Windows-based DHCP server to send option 43 to the DHCP client on an Aruba AP consists of the following two tasks:

- Configuring Option 60
- Configuring Option 43

DHCP servers are a popular way of configuring clients with basic networking information such as an IP address, a default gateway, network mask, DNS server, and so on. Most DHCP servers have the ability to also send a variety of optional information, including the Vendor-Specific Option Code, also called option 43.

When a client or an AP requests for option 43 (Vendor Specific Information), the managed device responds with the value configured by administrator in the DHCP pool.

### Configuring Option 60

This section describes how to configure the Vendor Class Identifier Code (option 60) on a Microsoft Windows-based-DHCP server.

Option 60 identifies and associates a DHCP client with a particular vendor. Any DHCP server configured to take action based on a client's vendor ID should also have this option configured.

Since option 60 is not a predefined option on a Windows DHCP server, you must add it to the option list for the server.

### Configuring Option 60 using the Windows DHCP Server

1. On the DHCP server, open the DHCP server administration tool by clicking **Start > AdministrativeTools > DHCP**.
2. Find your server and right-click on the scope to be configured under the server name. Select **Set Predefined Options**.
3. In the **Predefined Options and Values** dialog box, click **Add**.
4. In the **Option Type** dialog box, enter the following information:

**Table 245:** *Configuring Option 60 Using Windows DHCP Server*

Field	Information
Name	Aruba access point
Data Type	String
Code	60
Description	Aruba AP vendor class identifier

5. Click **OK** to save this information.
6. In the **Predefined Options and Values** dialog box, ensure **060 Aruba Access Point** is selected from the **Option Name** drop-down list.
7. In the **Value** field, enter the following information:  
String: ArubaAP
8. Click **OK** to save this information.
9. Under server, select the scope you want to configure and expand it. Select **Scope Options**, then select **Configure Options**.
10. In the **Scope Options** dialog box, scroll down and select **060 Aruba Access Point**. Confirm the value is set to **ArubaAP** and click **OK**.

Confirm that the option **060 Aruba Access Point** is listed in the right pane.

## Configuring Option 43

Configuring Option 43 returns the IP address of the Aruba Mobility Master to an Aruba DHCP client. This information allows Aruba APs to auto-discover the Mobility Master and obtain their configuration.

### Configuring Option 43 Using the Windows DHCP Server:

1. On the DHCP server, navigate to **Start > Administration Tools > DHCP** to open the DHCP server administration tool.
2. Find your server and right-click on the scope to be configured under the server name. Click on the **Scope Options** entry and select **Configure Options**.
3. In the **Scope Options** dialog box, scroll down and select **043 Vendor Specific Info**.
4. In the **Data Entry** field, click anywhere in the area under the ASCII heading and enter ASCII : Loopback address of the Mobility Master.
5. Click **OK** to save the configuration.

Option 43 is configured for this DHCP scope. Though you entered the IP address in ASCII text, the IP address is displayed in binary form.

## Enabling DHCP Relay Agent Information Option (Option 82)

The DHCP Relay Agent Information option (Option 82) allows the DHCP Relay Agent to insert circuit-specific information into a request that is being forwarded to a DHCP server.

The managed device, when acting as a DHCP relay agent, inserts information about the AP and BSSID through which a client connects to the DHCP request. Many service providers use this mechanism to make access control decisions.

## Configuring Option 82

You can configure Option 82 using the WebUI or the CLI.

### In the WebUI

1. In the **Managed Network** node hierarchy, navigate to **Configuration > Interfaces > VLANs** page.
2. Select the VLAN ID for which you want to configure Option 82. The **VLANs** table is displayed.
3. From the **VLANs >** table select the VLAN ID again.
4. Select **IPv4** tab from the table that is displayed.
5. Select **Static** from the **IP assignment** drop-down list.
6. Select **AP Name ESSID**, **MAC**, or **MAC ESSID** from the **Option-82** drop-down list.
7. Click **Submit**.
8. Click **Pending Changes**.
9. In the **Pending Changes** window, select the check box and click **Deploy changes**.

### In the CLI

Use the `interface vlan option-82` option to enable **Option 82** for a VLAN using ESSID. You can include:

- AP name - AP Name (Circuit ID 0x00000000, Remote ID <AP-Name>:<ESSID>)
- MAC - BSSID (Circuit ID <BSSID>, Remote ID <ESSID>).

## Enabling Linux DHCP Servers

The following is an example configuration for the Linux `dhcpd.conf` file. After you enter the configuration, you must restart the DHCP service.

```
option serverip code 43 = ip-address;
class "vendor-class" {
    match option vendor-class-identifier;
}
.
.
.
subnet 10.200.10.0 netmask 255.255.255.0 {
    default-lease-time 200;
    max-lease-time 200;
    option subnet-mask 255.255.255.0;
    option routers 10.200.10.1;
    option domain-name-servers 10.4.0.12;
    option domain-name "vlan10.aa.mycorpnetworks.com";
    subclass "vendor-class" "ArubaAP" {
        option vendor-class-identifier "ArubaAP";
    }
#
# option serverip <loopback-IP-address-of-master-controller>
#
    option serverip 10.200.10.10;
}
range 10.200.10.200 10.200.10.252;
}
```

This chapter provides examples of how to configure a Microsoft Internet Authentication Server, and a Windows XP wireless client for 802.1X authentication with the Mobility Master. For more information on 802.1X Authentication, see [802.1X Authentication on page 235](#).

For more information about configuring computers in a Windows environment for PEAP-MS-CHAPv2 and EAP-TLS authentication, see the Microsoft document *Step-by-Step Guide for Setting Up Secure Wireless Access in a Test Lab*, available from Microsoft's Download Center at [www.microsoft.com/downloads](http://www.microsoft.com/downloads). Additional information on client configuration is available at <http://www.microsoft.com/technet/prodtechnol/winxppro/maintain/wificomp.mspx#EQGAC>.

This chapter describes the following topics:

- [Configuring Microsoft IAS on page 1062](#)
- [Configuring Management Authentication Using IAS on page 1064](#)
- [Window XP Wireless Client Sample Configuration on page 1066](#)

## Configuring Microsoft IAS

Microsoft Internet Authentication Server (IAS) provides authentication functions for wireless networks. IAS implements the RADIUS protocol, which is used between the Aruba Mobility Master and the server. IAS uses Active Directory as the database for looking up computers, users, passwords, and group information.

### RADIUS Client Configuration

Each device in the network that needs to authenticate to a RADIUS server must be configured as a RADIUS client. You must configure the Aruba Mobility Master as a RADIUS client.



---

The steps to perform this task may vary depending on the version of Windows currently running on your server. For complete details on configuring Windows IAS, refer to the Windows documentation available at [www.microsoft.com/downloads](http://www.microsoft.com/downloads).

---

To configure a RADIUS client:

1. From your Windows server, navigate to **Start > Settings > Control Panel > Administrative Tools > Internet Authentication Service**.
2. In the **Internet Authentication Service** window, select **RADIUS Clients**.
3. To configure a RADIUS client, select **Action > New RADIUS Client** from the menu at the top of the window.
4. In the **New RADIUS Client** dialog window, enter the name and IP address for the Mobility Master. Click **Next**.
5. Enter and confirm a shared secret.  
The shared secret is configured on both the RADIUS server and client, and ensures that an unauthorized client cannot perform authentication against the server.
6. Click **Finish**.

## Remote Access Policies

The IAS policy configuration defines all policies related to wireless access, including time of day restrictions, session length, authentication type, and group-related policies. See Microsoft product documentation for detailed descriptions and explanations of IAS policy settings.

## Active Directory Database

The Active Directory database serves as the master authentication database for both the wired and wireless networks. The IAS authentication server bases all authentication decisions on information in the Active Directory database. IAS is normally used as an authentication server for remote access and thus looks to the Active Directory “Remote Access” property to determine whether authentication requests should be allowed or denied. This property is set on a per-user or per-computer basis. For a user or computer to be allowed access to the wireless network, the remote access property must be set to “Allow access”.

The authentication policy configured in IAS depends on the group membership of the computer or user in the Active Directory. These policies are responsible for passing group information back to the Mobility Master for use in assigning computers or users to the correct role, which determines their network access privileges. When the IAS server receives a request for authentication, it compares the request with the list of remote access policies. The first policy to match the request is executed; additional policies are not searched.

## Configuring Policies

The policies in this 802.1X authentication example are designed to work by examining the username portion of the authentication request, searching the Active Directory database for a matching name, and then examining the group membership for a computer or user entry that matches. For example, the following policies would operate with the Mobility Master configuration shown in [Configuring Authentication with an 802.1X RADIUS Server on page 248](#):

- The Wireless-Computers policy matches the Domain Computers group. This group contains the list of all computers that are members of the domain. This group is used for all computers to authenticate to the network.
- The Wireless-Student policy matches the Student group. This group is used for all student users.
- The Wireless-Faculty policy matches the Faculty group. This group is used for all faculty users.
- The Wireless-Sysadmin policy matches the Sysadmin group. This group is used for system administrators.

In addition to matching the respective group, the policy also specifies that the request must be from an 802.11 wireless device. The policy instructs IAS to grant remote access permission if all the conditions specified in the policy match, a valid username/password is supplied, the user’s or computer’s remote access permission is set to “Allow”.

To configure a policy:

1. In the **Internet Authentication Service** window, select **Remote Access Policies**.
2. Navigate to **Action > New Remote Access Policy** to add a new policy.
3. Click **Next** on the initial wizard window to proceed.
4. Enter a name for the policy, for example, Wireless Computers and click **Next**.
5. In the **Access Method** window, select the **Wireless** option, then click **Next**.
6. In the **User or Group Access** window, select **Group** and click **Add** to add the group of users to which this policy applies (for example, “Domain Computers”). Click **Next**.
7. For **Authentication Methods**, select either **Protected EAP (PEAP)** or **Smart Card** or **Other Certificate**.
8. Click **Configure** to select additional properties.
9. Select a server certificate.

The list of available certificates is taken from the computer certificate store on which IAS is running. In this case, a self-signed certificate was generated by the local certificate authority and installed on the IAS system. On each wireless client device, the local certificate authority is added as a trusted certificate authority, thus allowing this certificate to be trusted.

10. For PEAP, select the inner authentication method.

The authentication method shown is MS-CHAPv2. This should be the only EAP authentication type that should be selected as password authentication is being used on this network.

You can also enable fast reconnect in this screen. If you enable fast reconnect here and also on client devices, additional time can be saved when multiple authentications take place (such as when clients are roaming between APs frequently) because the server will keep the PEAP encrypted tunnel alive.

11. Click **OK**.

## Configuring RADIUS Attributes

In the configuration example for 802.1X, the Mobility Master restricts network access privileges based on the group membership of the computer or user. In order for this to work, the Mobility Master must be told to which group the user belongs. This is accomplished using RADIUS attributes returned by the authentication server.

To configure RADIUS attributes:

1. In the **Internet Authentication Service** window, select **Remote Access Policies**.
1. Open the remote access policy you want to configure, and select the **Advanced** tab.
2. Click **Add** to configure an attribute.
3. Select the **Class** attribute.
4. Enter the value for this attribute. For example, for the **Wireless-Computers** policy, the **Class** attribute returned to the Mobility Master should contain the value "computer".
5. Click **OK**.

Another example of a **Class** attribute configuration is shown below for the Wireless-Student policy. This policy returns the RADIUS attribute **Class** with the value "student" after successful completion.

## Configuring Management Authentication Using IAS

Before you can configure the Mobility Master for management authentication using Windows IAS, you must perform the following steps to configure a Windows IAS RADIUS server on your Windows client.



---

The steps to perform this task may vary depending on the version of Windows currently running on your server. For complete details on configuring Windows IAS, refer to the Windows documentation available at [www.microsoft.com/downloads](http://www.microsoft.com/downloads).

---

1. From your Windows server, navigate to **Start > Settings > Control Panel > Administrative Tools > Internet Authentication Service**. The **Internet Authentication Service** window is displayed.
2. Verify if IAS is running.  
If IAS is running, a green arrow icon is displayed at the top of this window. If it has stopped, a red stop icon will appear. If the service is not active, click the green arrow icon to restart the service.
3. From the **Internet Authentication Service** window, right click the **Radius Clients** folder and select **New Radius Client**. The **New RADIUS Client** window is displayed.
4. Enter a name for the RADIUS client and enter the Mobility Master's IP address or DNS name. Click **Next**.
5. Enter and confirm the shared secret key for the Mobility Master. Click **Finish**.



## Creating a Remote Policy

1. From the **Internet Authentication Service** window, right click the **Remote Access Policies** folder and select **New Remote Access Policy**.
2. The **New Remote Access Policy** wizard is displayed. Click **Next** on the first window to start the wizard.
3. Select **Use the wizard to set up a typical Policy for a common scenario** and enter a name for the policy. Click **Next**.
4. In the **Access Method** window of the wizard, select the method you will use to gain management access to the network. Click **Next**.
5. In the **User or Group Access** window of the wizard, select either **user** or **group**, depending upon how your user permissions are defined. Click **Next**.
6. In the **Authentication Method** window, click the **Type** drop-down list and select **Protected EAP (PEAP)**. Click **Next**.
7. Click **Finish**.

## Defining Properties for Remote Policy

1. In the **Internet Authentication Service** window, click the **Remote Access Policy** icon. All configured remote access policies are displayed in the right window pane.
2. Right-click the policy you just created, and select **Properties**. The **Properties** window is displayed.
3. Select the **Grant remote access permission** option, and click **Edit Profile**. The **Edit Profile** window is displayed.
4. Click the **Authentication** tab and select the authentication methods that include **MS-CHAP**, **MS-CHAP V2**, and **PAP**.
5. Click **Apply**.
6. Click the **Advanced** tab.
7. Click **Add**. The **Add Attribute** window is displayed.
8. Scroll down the list of attributes and select **Vendor-Specific**, then click **Add**. The **MultiValued Attribute Information** window is displayed.
9. Click **Add**.
10. Enter the vendor code **14823** and select the option **Yes, it conforms**.
11. Click **Configure Attribute**. The **Configure VSA** window is displayed.
12. In the **Vendor-assigned attribute number** field, enter **3**.
13. In the **Attribute value** field, enter **7**.
14. Click **OK** to save the settings.
15. Click **Apply**.
16. Click **Apply**.

Now that you have defined your remote policy properties, you must create a user entry in the Windows active directory. The steps to complete this process will vary, depending on the version of Windows currently running on your server. The procedure below should be used only as a guideline.

## Creating a User Entry in Windows Active Directory

1. Open the **Active Directory Users and Computers** tool on your Windows server.
2. Create a new user entry on the Windows Active directory.
3. Once you have created the new user, right-click the user name and select **Properties**.
4. Click the **Dial-in** tab and select **"Allow access"** for the user.

5. Click **OK** to save your settings.

## Configure the Mobility Master to Use IAS Management Authentication

The following procedure describes the steps to configure the Mobility Master to use IAS management authentication.

1. In the **Mobility Master** node hierarchy, navigate to **Configuration > Authentication > Auth Servers**.
2. Click **+** in **All Servers** table. The **New Server** dialog box is displayed.
3. Enter a value for following:
  - a. Name
  - b. IP address
  - c. From the **Type** drop-down list, select **Radius**.
4. Click **Submit**.
5. Select the Radius server that you created.
6. Enter and then retype the shared key for the server.
7. Click **Submit**.
8. Click **+** in **Server Groups** table. The **Add Server Group** dialog box is displayed.
9. Enter a name for the server group.
10. Click **Submit**.
11. Select the server group that you created.
12. Click **+** in **Server** table. A dialog box is displayed that prompts you to select a Radius server.
13. Ensure that the **Add existing server** option is selected.
14. Select the Radius server you created. Click **Submit**.
15. Click **Pending Changes**.
16. In the **Pending Changes** window, select the check box and click **Deploy changes**.

## Verify Communication Between the Mobility Master and RADIUS Server

After you have configured your Windows Server and the Mobility Master for Windows IAS Management Authentication, you can verify that the Mobility Master and server are communicating.

1. In the **Mobility Master** node hierarchy, navigate to **Diagnostics > Tools > AAA Server Test**.
2. Click the **Server Name** drop-down list and select the RADIUS server.
3. Select either **MSCHAP-V2** or **PAP** as the authentication method.
4. Enter the user name and password in the **Username** and **Password** fields.
5. Click **Begin Test**.

If the Mobility Master displays **Authentication Successful**, then the Mobility Master is able to communicate with the RADIUS server.

## Window XP Wireless Client Sample Configuration

This section shows an example of how to configure a Windows XP wireless client using Windows XP's Wireless Zero Configuration service.



---

The following steps apply to a computer running Windows XP Professional Version 2002 with Service Pack 2. To configure a wireless client on other Windows platforms, see your Microsoft Windows documentation.

---

1. On the desktop, right-click **My Network Places** and select **Properties**.

2. In the **Network Connections** window, right-click on **Wireless Network Connection** and select **Properties**.
3. Select the **Wireless Networks** tab. This screen displays the available wireless networks and the list of preferred networks. Windows connects to the preferred networks in the order in which they appear in the list.
4. Click the **Advanced** button to display the **Networks to access** window.  
This window determines what types of wireless networks the client can access. By default, Windows connects to any type of wireless network. Make sure that the option Computer-to-computer (ad hoc) networks only is *not* selected. Click **Close**.
5. In the **Wireless Networks** tab, click **Add** to add a wireless network.
6. Click the **Association** tab to enter the network properties for the SSID.



---

This tab configures the authentication and encryption used between the wireless client and the Aruba user-centric network. Therefore, the settings for the SSID that you configure on the client must match the configuration for the SSID on the Mobility Master.

---

- For an SSID using dynamic WEP, enter the following:
  - Network Authentication: Open
  - Data Encryption: WEP
  - Select the option “The key is provided for me automatically”. Each client will use a dynamically-generated WEP key that is automatically derived during the 802.1X process.
- For an SSID using WPA, enter the following:
  - Network Authentication: WPA
  - Data Encryption: TKIP
- For an SSID using WPA-PSK, enter the following:
  - Network Authentication: WPA-PSK
  - Data Encryption: TKIP
  - Enter the pre-shared key.
- For an SSID using WPA2, enter the following:
  - Network Authentication: WPA2
  - Data Encryption: AES
- For an SSID using WPA2-PSK, enter the following:
  - Network Authentication: WPA2-PSK
  - Data Encryption: AES
  - Enter the pre-shared key



---

Do not select the option “This is a computer-to-computer (ad hoc) network; wireless access points are not used”.

---

7. Click the **Authentication** tab to enter the 802.1X authentication parameters for the SSID. This tab configures the EAP type used between the wireless client and the authentication server.
  - Select Enable IEEE 802.1X authentication for this network.
  - Select Protected EAP (PEAP) for the EAP type.
  - Select Authenticate as computer when computer information is available. The client will perform computer authentication when a user is not logged in.

- Do not select Authenticate as guest when user or computer information is unavailable. The client will not attempt to authenticate as a guest.
  - Select Validate server certificate. This instructs the client to check the validity of the server certificate from an expiration, identity, and trust perspective.
  - Select the trusted Certification Authority (CA) that can issue server certificates for the network.
  - Select Secured password (EAP-MSCHAP v2) — the PEAP “inner authentication” mechanism will be an MS-CHAPv2 password.
  - Select Enable Fast Reconnect to speed up authentication in some cases.
8. Under **Select Authentication Method**, click **Configure** to display the **EAP-MSCHAPv2 Properties** window. Select the option Automatically use my Windows logon name and password (and domain if any). This option specifies that the user’s Windows logon information is used for authentication to the wireless network. This option allows the same logon credentials to be used for access to the Windows domain as well as the wireless network.

## Acronyms

The following table lists the acronyms and their definitions used in this guide.

**Table 246:** *List of acronyms*

Acronym	Definition
ABR	area border router
AC	access category
ACI	adjacent channel interference
ACL	access control list
ADP	Aruba Discovery Protocol (ADP)
AES	advanced encryption standard
AIFSN	arbitrary inter-frame space number
ALG	application level gateway
AM	air monitor
AP	access point
APM	AP air monitor
ARM	adaptive radio management
AVF	AntiVirus Firewall
A-MSDU	aggregate MAC service data unit
BCMC	broadcast and multicast
BRAS	broadband remote access server
BRE	basic regular expression
BPDU	bridge protocol data unit

Acronym	Definition
BSSID	basic service set identifier
CA	certification authority
CAC	call admission control
CAP	campus AP
CCA	clear channel assessment
CDP	Cisco Discovery Protocol
CDR	call detail records
CHAP	Challenge Handshake Authentication Protocol
CRL	certificate revocation list
CSA	channel switch announcement
CSMA/CA	carrier sense multiple access with collision avoidance
CSR	certificate signing request
CSS	content security service
CTS	clear to send
CW	contention window
DAS	distributed antenna systems
DCF	distributed coordination function
DES	data encryption standard
DHCP	Dynamic Host Configuration Protocol
DS	differentiated services
DSCP	differentiated services codepoint
DSSS	direct sequence spread spectrum

Acronym	Definition
DNS	domain name system
DoS	denial of service
DPD	dead peer detection
DR	designated router
DU	data unit
DMO	dynamic multicast optimization
EAP	Extensible Authentication Protocol
EAP-TLS	EAP-transport layer security
EDCA	enhanced distributed channel access
EIRP	effective isotropic radiated power
ESI	external service interfaces
ESS	extended service set
ESSID	extended service set identifier
FE	fast ethernet
FFT	fast fourier transform
FHSS	frequency-hopping spread spectrum
FIB	forwarding information base
FRER	frame receive error rate
FRR	frame retry rate
FSPL	free space path loss
FTP	File Transfer Protocol
FQLN	fully qualified location name

Acronym	Definition
GRE	generic routing encapsulation
GIS	generic interface specification
GMT	Greenwich Mean Time
GPP	guest provisioning page
HMD	high mobility device
HSPA	high-speed packet access
HT	high throughput
IAS	internet authentication server
IDS	intrusion detection system
IE	information element
IEEE	Institute of Electrical and Electronics Engineer
IGMP	Internet Group Management Protocol
IGP	Interior Gateway Routing Protocol
IKE PSK	internet key exchange pre-shared key
ISAKMP	Internet Security Association and Key Management Protocol
LACP	Link Aggregation Control Protocol
LAG	link aggregation group
LD	local debug
LDAP	Lightweight Directory Access Protocol
LEAP	Lightweight Extensible Authentication Protocol
LI	listening interval
L2TP	Layer-2 Tunneling Protocol



Acronym	Definition
MAC	media access control
MCS	modulation and coding scheme
MDPU	MAC protocol data unit
MIB	management information base
MIMO	multiple input, multiple output
MMS	mobility management system
MP	mesh point
MPP	mesh portal
MPV	mesh private VLAN
MSCHAP	Microsoft Challenge Handshake Authentication Protocol
MSCHAPv2	MSCHAP version 2
MSSID	mesh service set identifier
MPPE	Microsoft point-to-point encryption
MTU	maximum transmission unit
NAS	network access server
NAT	network address translation
NIC	network interface card
NOE	new office environment
NTP	Network Time Protocol
OCSP	Online Certificate Status Protocol
OFDM	orthogonal frequency division multiplexing
OKC	opportunistic key caching

Acronym	Definition
OSPF	open shortest path first
OUI	organizationally unique identifier
PAC	protected access credential
PAP	Password Authentication Protocol
PAPI	proprietary access protocol interface
PFS	perfect forward secrecy
PHB	per hop behavior
PIN	personal identification number
PKI	public key infrastructure
PMK	pairwise master key
PoE	power over ethernet
PSK	pre-shared key
PPPoE	point-to-point protocol over ethernet
PPTP	Point-to-Point Tunneling Protocol
PVST	per VLAN spanning tree
QoS	quality of service
RADIUS	remote authentication dial-in user service
RAP	remote AP
REGEX	region with the regular expression
RF	radio frequency
RFID	radio frequency identification
RoW	rest of world

Acronym	Definition
RSSI	received signal strength indication
RSTP	Rapid Spanning Tree Protocol
RTLS	real-time locating systems
RTS	request to send
SA	security association
SDR	software-defined radio
SIM	subscriber identity module
SIP	Session Initiation Protocol
SNIR	signal-to-noise-and-interference ratio
SNMP	Simple Network Management Protocol
SSID	service set identifier
STP	Spanning Tree Protocol
STRAP	secure thin remote access point
SVP	spectralink voice priority
TFTP	Trivial File Transfer Protocol
TIM	traffic indication map
TLS	transport layer security
TOS	type of service
TPM	trusted platform module
TSPEC	traffic specification
TXOP	opportunity to transmit
UDP	User Datagram Protocol

Acronym	Definition
UTMS	universal mobile telecommunication systems
U-APSD	unscheduled automatic power save delivery
VBA	virtual branch networking
VIA	virtual intranet access
VoFi	voice over Wi-Fi
VoIP	voice over IP
VPN	virtual private network
VRD	validated reference design
VRRP	Virtual Router Redundancy Protocol
VSA	vendor specific attributes
VTP	Virtual Trunking Protocol
WIDS	wireless intrusion detection system
WINS	windows internet naming service
WIPS	wireless intrusion prevention system
WISPr	wireless internet service provider roaming
WLAN	wireless local area network
WMM	wireless multimedia
WMS	WLAN management system
WSIRT	wireless security incident response team
WZC	wireless zero config
XAuth	extended authentication

## Terms

The following table lists the terms and their definitions used in this guide.

**Table 247:** *List of terms*

Term	Definition
802.11	An evolving family of specifications for wireless LANs developed by a working group of the Institute of Electrical and Electronics Engineers (IEEE). 802.11 standards use the Ethernet protocol and CSMA/CA (carrier sense multiple access with collision avoidance) for path sharing.
802.11a	Provides specifications for wireless systems. Networks using 802.11a operate at radio frequencies in the 5GHz band. The specification uses a modulation scheme known as orthogonal frequency-division multiplexing (OFDM) that is especially well suited to use in office settings.
802.11b	WLAN standard often called Wi-Fi; backward compatible with 802.11. Instead of the phase-shift keying (PSK) modulation method historically used in 802.11 standards, 802.11b uses complementary code keying (CCK), which allows higher data speeds and is less susceptible to multipath-propagation interference.
802.11d	A wireless network communications specification for use in countries where systems using other standards in the 802.11 family are not allowed to operate. Configuration can be fine-tuned at the Media Access Control layer (MAC layer) level to comply with the rules of the country or district in which the network is to be used. Rules subject to variation include allowed frequencies, allowed power levels, and allowed signal bandwidth. 802.11d facilitates global roaming.
802.11e	A proposed adaptation to the 802.11a and 802.11b specifications that enhances the 802.11 Media Access Control layer (MAC layer) with a coordinated time division multiple access (TDMA) construct, and adds error-correcting mechanisms for delay-sensitive applications such as voice and video. The 802.11e specification provides seamless interoperability between business, home, and public environments such as airports and hotels and offers all subscribers high-speed Internet access with full-motion video, high-fidelity audio, and Voice over IP (VoIP).
802.11g	Offers transmission over relatively short distances at up to 54 megabits per second (Mbps), compared with the 11 Mbps theoretical maximum of 802.11b. 802.11g employs orthogonal frequency division multiplexing (OFDM), the modulation scheme used in 802.11a, to obtain higher data speed. Computers or terminals set up for 802.11g can fall back to speeds of 11 Mbps, so that 802.11b and 802.11g devices can be compatible within a single network.
802.11h	Intended to resolve interference issues introduced by the use of 802.11a in some locations, particularly with military radar systems and medical devices. Dynamic frequency selection (DFS) detects the presence of other devices on a channel and automatically switches the network to another channel if and when such signals are detected. Transmit power control (TPC) reduces the radio-frequency (RF) output power of each network transmitter to a level that minimizes the risk of interference.

Term	Definition
802.11i	Provides improved encryption for networks that use 802.11a, 802.11b, and 802.11g standards. Requires new encryption key protocols, known as Temporal Key Integrity Protocol (TKIP) and Advanced Encryption Standard (AES). Other features include key caching, which facilitates fast reconnection to the server for users who have temporarily gone offline, and pre-authentication, which allows fast roaming and is ideal for use with advanced applications such as Voice over Internet Protocol (VoIP).
802.11j	Proposed addition to the 802.11 family of standards that incorporates Japanese regulatory extensions to 802.11a; the main intent is to add channels in the radio-frequency (RF) band of 4.9 GHz to 5.0 GHz. WLANs using 802.11j will provide for speeds of up to 54 Mbps, and will employ orthogonal frequency division multiplexing (OFDM). The specification will define how Japanese 802.11 family WLANs and other wireless systems, particularly HiperLAN2 networks, can operate in geographic proximity without mutual interference.
802.11k	Proposed standard for how a WLAN should perform channel selection, roaming, and transmit power control (TPC) to optimize network performance. In a network conforming to 802.11k, if the access point (AP) having the strongest signal is loaded to capacity, a wireless device is connected to one of the under used APs. Even though the signal may be weaker, the overall throughput is greater because more efficient use is made of the network resources.
802.11n	Wireless networking standard to improve network throughput over the two previous standards 802.11a and 802.11g with a significant increase in the maximum raw data rate from 54 Mbit/s to 600 Mbit/s with the use of four spatial streams at a channel width of 40 MHz.
802.11m	An initiative to perform editorial maintenance, corrections, improvements, clarifications, and interpretations relevant to documentation for 802.11 family specifications. 802.11m also refers to the set of maintenance releases itself.
802.11 bSec	<p>The bSec protocol is a pre-standard protocol that has been proposed to the IEEE 802.11 committee as an alternative to 802.11i. The difference between bSec and standard 802.11i is that bSec implements Suite B algorithms whenever possible. Notably, AES-CCM is replaced by AES-CGM, and the Key Derivation Function (KDF) of 802.11i is upgraded to support SHA-256 and SHA-384.</p> <p>To provide interoperability with standard Wi-Fi software drivers, bSec is implemented as a shim layer between standard 802.11 Wi-Fi and a Layer 3 protocol such as IP. A controller configured to advertise a bSec SSID will advertise an open network, however only bSec frames will be permitted on the network.</p>
802.1X	Standard designed to enhance 802.11 WLAN security. 802.1X provides an authentication framework, allowing a user to be authenticated by a central authority. The actual algorithm that is used to determine whether a user is authentic is left open and multiple algorithms are possible.

Term	Definition
access point (AP)	An access point connects users to other users within the network and also can serve as the point of interconnection between the WLAN and a fixed wire network. The number of access points a WLAN needs is determined by the number of users and the size of the network.
access point mapping	The act of locating and possibly exploiting connections to WLANs while driving around a city or elsewhere. To do war driving, you need a vehicle, a computer (which can be a laptop), a wireless Ethernet card set to work in promiscuous mode, and some kind of an antenna which can be mounted on top of or positioned inside the car. Because a WLAN may have a range that extends beyond an office building, an outside user may be able to intrude into the network, obtain a free Internet connection, and possibly gain access to company records and other resources.
ad hoc network	A LAN or other small network, especially one with wireless or temporary plug-in connections, in which some of the network devices are part of the network only for the duration of a communications session or, in the case of mobile or portable devices, while in some close proximity to the rest of the network.
A-MSDU	A structure containing multiple MSDUs, transported within a single (unfragmented) data medium access control (MAC) protocol data unit (MPDU).
band	A specified range of frequencies of electromagnetic radiation.
digital wireless pulse	Wireless technology for transmitting large amounts of digital data over a wide spectrum of frequency bands with very low power for a short distance. Ultra wideband radio can carry a huge amount of data over a distance up to 230 feet at very low power (less than 0.5 milliwatts), and has the ability to carry signals through doors and other obstacles that tend to reflect signals at more limited bandwidths and a higher power.
evil twin	A home-made wireless access point that masquerades as a legitimate one to gather personal or corporate information without the end-user's knowledge. It's fairly easy for an attacker to create an evil twin by simply using a laptop, a wireless card and some readily-available software. The attacker positions himself in the vicinity of a legitimate Wi-Fi access point and lets his computer discover what name and radio frequency the legitimate access point uses. He then sends out his own radio signal, using the same name.
extensible authentication protocol (EAP)	Authentication protocol for wireless networks that expands on methods used by the point-to-point protocol (PPP), a protocol often used when connecting a computer to the Internet. EAP can support multiple authentication mechanisms, such as token cards, smart cards, certificates, one-time passwords, and public key encryption authentication.

Term	Definition
fixed wireless	Wireless devices or systems in fixed locations such as homes and offices. Fixed wireless devices usually derive their electrical power from the utility mains, unlike mobile wireless or portable wireless which tend to be battery-powered. Although mobile and portable systems can be used in fixed locations, efficiency and bandwidth are compromised compared with fixed systems.
frequency allocation	Use of radio frequency spectrum regulated by governments.
frequency spectrum	Part of the electromagnetic spectrum.
goodput	<p>Goodput is the ratio of the total bytes transmitted or received in the network to the total air time required for transmitting or receiving the bytes. The air time includes the retransmission time taken for both successful and dropped frames. Suppose 1000 frames of 1500 bytes each are transmitted in the network as follows:</p> <ul style="list-style-type: none"> <li>• 50% of frames are transmitted successfully at MCS index 11 at 108 Mbps.</li> <li>• 25% of the frames were dropped in the 1st attempt at 108 Mbps but were successfully transmitted using MCS index 3 at 54 Mbps in the second attempt.</li> <li>• The remaining 25% are dropped in both the attempts.</li> </ul> <p>Then the effective rate is calculated as: The total bits transmitted / the total air time. In this example: <math>(500 * 1500 + 250 * 1500) * 8 / (\text{total air time for 50\% frames} + \text{total air time for 25\% frames retransmitted} + \text{total air time for 25\% dropped frames}) = 40.5 \text{ Mbps}</math>.</p>
hot spot	A WLAN node that provides Internet connection and virtual private network (VPN) access from a given location. A business traveller, for example, with a laptop equipped for Wi-Fi can look up a local hot spot, contact it, and get connected through its network to reach the Internet and their own company remotely with a secure connection. Increasingly, public places, such as airports, hotels, and coffee shops are providing free wireless access for customers.
hot zone	A wireless access area created by multiple hot spots located in close proximity to each other. Hot zones usually combine public safety access points with public hot spots. Each hot spot typically provides network access for distances between 100 and 300 feet; various technologies, such as mesh network topologies and fiber optic backbones, are used in conjunction with the hot spots to create areas of coverage.
Infrared Data Association (IrDA)	An industry-sponsored organization set up in 1993 to create international standards for the hardware and software used in infrared communication links. In this special form of radio transmission, a focused ray of light in the infrared frequency spectrum, measured in terahertz, or trillions of hertz (cycles per second), is modulated with information and sent from a transmitter to a receiver over a relatively short distance



Term	Definition
IR wireless	The use of wireless technology in devices or systems that convey data through infrared (IR) radiation. Infrared is electromagnetic energy at a wavelength or wavelengths somewhat longer than those of red light. The shortest-wavelength IR borders visible red in the electromagnetic radiation spectrum; the longest-wavelength IR borders radio waves.
microwave	Electromagnetic energy having a frequency higher than 1 gigahertz (billions of cycles per second), corresponding to wavelength shorter than 30 centimeters. Microwave signals propagate in straight lines and are affected very little by the troposphere. They are not refracted or reflected by ionized regions in the upper atmosphere. Microwave beams do not readily diffract around barriers such as hills, mountains, and large human-made structures.
MIMO	An antenna technology for wireless communications in which multiple antennas are used at both the source (transmitter) and the destination (receiver). The antennas at each end of the communications circuit are combined to minimize errors and optimize data speed. MIMO is one of several forms of smart antenna technology, the others being MISO (multiple input, single output) and SIMO (single input, multiple output).
MISO	An antenna technology for wireless communications in which multiple antennas are used at the source (transmitter). The antennas are combined to minimize errors and optimize data speed. The destination (receiver) has only one antenna. MISO is one of several forms of smart antenna technology, the others being MIMO (multiple input, multiple output) and SIMO (single input, multiple output).
near field communication (NFC)	A short-range wireless connectivity standard (Ecma-340, ISO/IEC 18092) that uses magnetic field induction to enable communication between devices when they're touched together, or brought within a few centimeters of each other. The standard specifies a way for the devices to establish a peer-to-peer (P2P) network to exchange data.
optical wireless	The combined use of conventional radio-frequency (RF) wireless and optical fiber for telecommunication. Long-range links are provided by optical fiber and links from the long-range end-points to end users are accomplished by RF wireless or laser systems. RF wireless at ultra-high frequencies (UHF) and microwave frequencies can carry broadband signals to individual computers at substantial data speeds.
OCSP Client	The ArubaOScontroller can act as an OCSP client and issues OCSP queries to remote OCSP responders located on the intranet or Internet.
OCSP Responder	The OCSP client retrieves certificate revocation status from an OCSP responder. The responder may be the certificate authority (CA) that has issued the certificate in question or it may be some other designated entity which provides the service on behalf of the CA.
radio frequency (RF)	Portion of electromagnetic spectrum in which electromagnetic waves are generated by feeding alternating current to an antenna.

Term	Definition
structured wireless-aware network (SWAN)	A technology that incorporates a WLAN into a wired wide-area network (WAN). SWAN technology can enable an existing wired network to serve hundreds of users, organizations, corporations, or agencies over a large geographic area. A SWAN is said to be scalable, secure, and reliable.
secure copy (SCP)	Secured encrypted command to copy files across an ssh connection, Files can be copied from or to a remote server, and also from one remote server to another.
transponder	A wireless communications, monitoring, or control device that picks up and automatically responds to an incoming signal. The term is a contraction of the words transmitter and responder. Transponders can be either passive or active.
ultra high frequency (UHF)	International Telecommunication Union (ITU) band 9, 300-3000 MHz, 1m - 100 mm frequency wavelength.
ultra wideband (UWB)	Is a wireless technology for transmitting large amounts of digital data over a wide spectrum of frequency bands with very low power for a short distance. Ultra wideband broadcasts very precisely timed digital pulses on a carrier signal across a very wide spectrum (number of frequency channels) at the same time. UWB can carry a huge amount of data over a distance up to 230 feet at very low power (less than 0.5 milliwatts), and has the ability to carry signals through doors and other obstacles that tend to reflect signals at more limited bandwidths and a higher power.
virtual private network (VPN)	A network that uses a public telecommunication infrastructure, such as the Internet, to provide remote offices or individual users with secure access to their organization's network. A VPN ensures privacy through security procedures and tunneling protocols such as the Layer Two Tunneling Protocol ( L2TP ). Data is encrypted at the sending end and decrypted at the receiving end.
voice over WLAN (VoWLAN)	A method of routing telephone calls for mobile users over the Internet using the technology specified in IEEE 802.11b. Routing mobile calls over the Internet makes them free, or at least much less expensive than they would be otherwise.
wideband code-division multiple access (W-CDMA)	Officially known as IMT-2000 direct spread; ITU standard derived from Code-Division Multiple Access (CDMA). W-CDMA is a third-generation (3G) mobile wireless technology that promises much higher data speeds to mobile and portable wireless devices than commonly offered in today's market.
Wi-Fi	A term for certain types of WLANs. Wi-Fi can apply to products that use any 802.11 standard. Wi-Fi has gained acceptance in many businesses, agencies, schools, and homes as an alternative to a wired LAN. Many airports, hotels, and fast-food facilities offer public access to Wi-Fi networks.

Term	Definition
WiMAX	A wireless industry coalition whose members organized to advance IEEE 802.16 standards for broadband wireless access (BWA) networks. WiMAX 802.16 technology is expected to enable multimedia applications with wireless connection and, with a range of up to 30 miles, enable networks to have a wireless last mile solution. According to the WiMAX forum, the group's aim is to promote and certify compatibility and interoperability of devices based on the 802.16 specification, and to develop such devices for the marketplace.
wired equivalent privacy (WEP)	A security protocol specified in 802.11b, designed to provide a WLAN with a level of security and privacy comparable to what is usually expected of a wired LAN. Data encryption protects the vulnerable wireless link between clients and access points; once this measure has been taken, other typical LAN security mechanisms such as password protection, end-to-end encryption, virtual private networks (VPNs), and authentication can be put in place to ensure privacy.
wireless	Describes telecommunications in which electromagnetic waves (rather than some form of wire) carry the signal over part or all of the communication path.
wireless abstract XML (WAX)	Describes telecommunications in which electromagnetic waves (rather than some form of wire) carry the signal over part or all of the communication path.
wireless application service provider (WASP)	Provides Web-based access to applications and services that would otherwise have to be stored locally and makes it possible for customers to access the service from a variety of wireless devices, such as a smartphone or personal digital assistant (PDA).
wireless ISP (WISP)	An internet service provider (ISP) that allows subscribers to connect to a server at designated hot spots (access points) using a wireless connection such as Wi-Fi. This type of ISP offers broadband service and allows subscriber computers, called stations, to access the Internet and the Web from anywhere within the zone of coverage provided by the server antenna, usually a region with a radius of several kilometers.
wireless service provider	A company that offers transmission services to users of wireless devices through radio frequency (RF) signals rather than through end-to-end wire communication.
wireless local area network (WLAN)	A local area network (LAN) that users access through a wireless connection. 802.11 standards specify WLAN technologies. WLANs are frequently some portion of a wired LAN.
yagi antenna	A unidirectional antenna commonly used in communications when a frequency is above 10 MHz.