

ARCHIMEDES WIND TURBINE

Energy for you, by you.
A wind turbine everybody can afford!



 **Respect**



Thumb Index

Company Vision & Mission	05
Patents & Certificates	05
Product Introduction & Applications	06
Technical Information	08
Other Information	09
Static Wind Loads	10
Part Description	11
Connection Methods	12
Global Track Record	13
Video Links	14



Respect

RESPECT fulfills customer satisfaction by care and commitment to its developments

Company vision

A healthy world and a happy life in a social responsible manner.

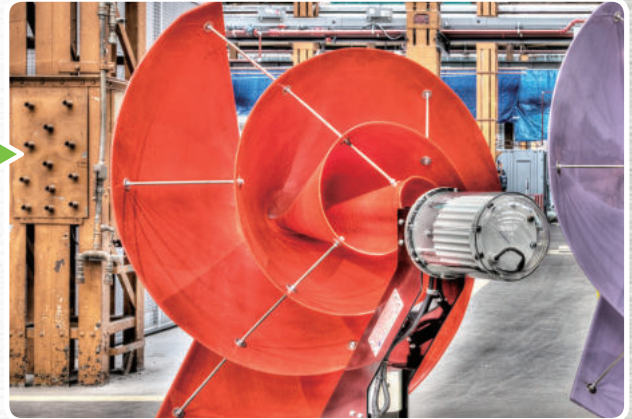

Company Mission

Environmental and renewable energy solution for all.



To Fulfill customer satisfaction,
RESPECT creates the best development values
in various fields.

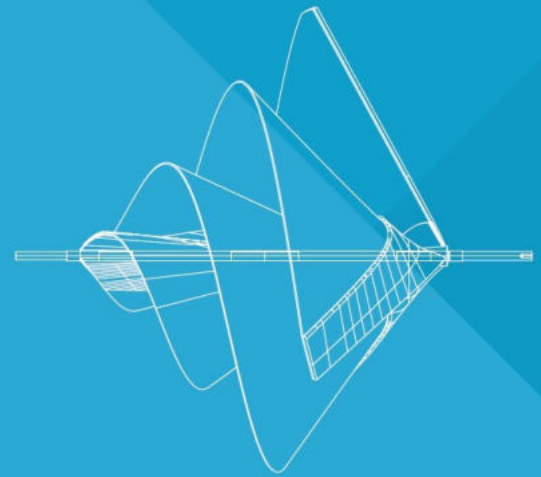

Company Vision

Becoming one of the leading companies for environmental renewable energy solutions, by introducing and providing innovative technology in a socially responsible manner.

Company Mission

Introduce environmental and renewable energy devices all over the world, through innovative and beneficial production processes, which are aligned with the development of local communities and the care and protection of the environment.

The company wants to have a positive impact on society by investing, sharing and applying its experience, technical knowhow and its teams of professionals worldwide.

Patent List

- Spiral blade unit and wind generator and blade connector for the unit
- Blade having a divided shaft and blade unit utilizing the blade and method for making the blade unit
- Rotation shaft, rotation blade unit having the shaft and parts for making the unit
- Spiral blade unit and wind generator and blade connector for the unit
- Spiral blade unit and wind generator
- Spiral blade having improved injection moldability and spiral blade unit having the same



CE / COC Certificate



Pusan National University Field test



KCL High Wind Speed Survival Certificate AWM 750-D



KCL High Wind Speed Survival Certificate AWM 1500-D

1. COC : Code of Conduct
2. CE : European Certificate
3. KCL : Korean Certification Laboratories



Product Introduction

The AWM proves to be highly efficient (about 35% of all kinetic energy in the air), is very silent (below 45 dB), is bird and bat friendly and has a beautiful design, suitable for urban and rural areas.

The AWM comes in two sizes:

01/ The 1.5 meter diameter with a rated power of 550 w/h and a maximum of 700 w/h.

02/ The 0.75 meter diameter with a rated power of 100 w/h and a maximum of 150 w/h.



Front View



Rear View

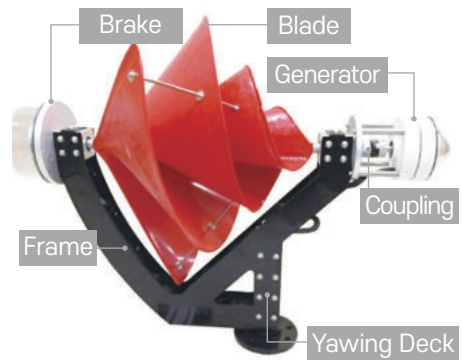

Side View



Examples of Application

AWM-Application

AWM-Urban Street Lights



AWM-Electric car station



AWM-Farm support



AWM-Urban Street Lights



ARCHIMEDES WIND TURBINE

The AWM turbine has a unique and recognizable design. They are designed to be highly efficient, very silent, safe and carefree. Both sizes are designed with the same features, only the output is different. The turbine almost acts like a weather vane. It needs no hardware or software to face the optimal wind

direction. For emergency or maintenance purposes, an electric brake is installed at the back.

The performance remains the same even with dirt, snow or rain. It can handle turbulent air as no other turbine can, The turbine is bat and bird friendly. Simply said, It outperforms all of its competition.

Technical Information Power

THE WIND TURBINE			
MODEL NAME		AWM - 750D	AWM - 1500D
POWER	ELECTRIC	100W	550W
	KINETIC	150W	700W
WIND SPEED	CUT IN	3m/s (OPERATING)	
	RATED	12.5m/s	
	CUT OUT	14 m/s	
	SURVIVAL	35 m/s	
BLADE RPM	RATED	550	330
	CUT OUT	600	360
SIZE		0.75m(W)×1.1m(L)×1.1m(H)	1.5m(W)×1.9m(L)×1.75m(H)
ROTOR DIAMETER		750 mm	1500 mm
SWEPT AREA		0.44 m ²	1.77 m ²
NET WEIGHT		60Kg	280kg
CONTROL SYSTEM		Mppt control Auto & Manual Braking System	

Power Curve

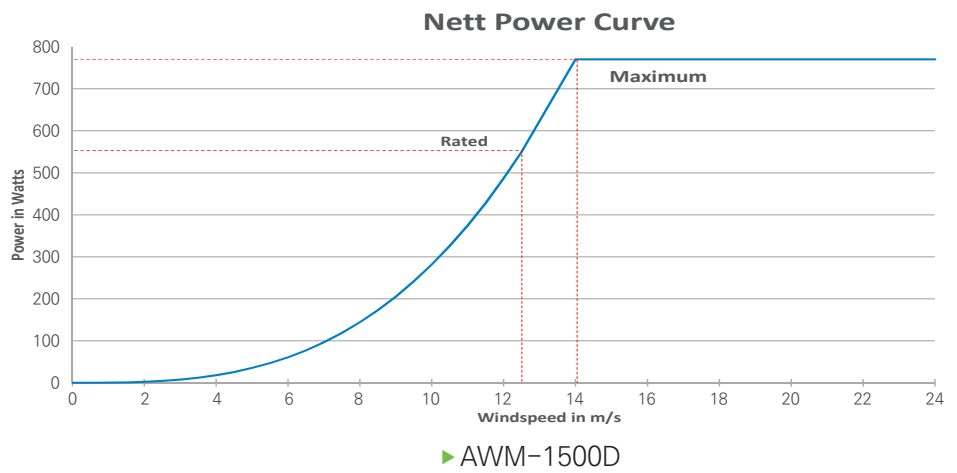
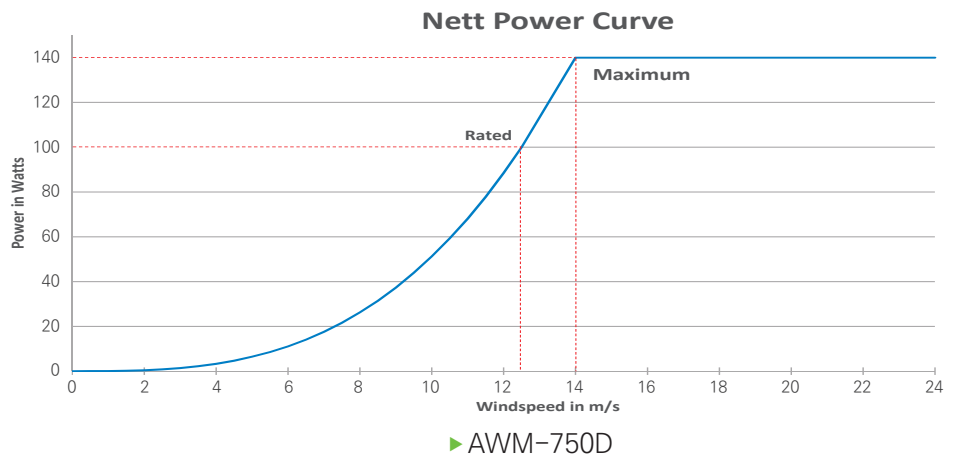

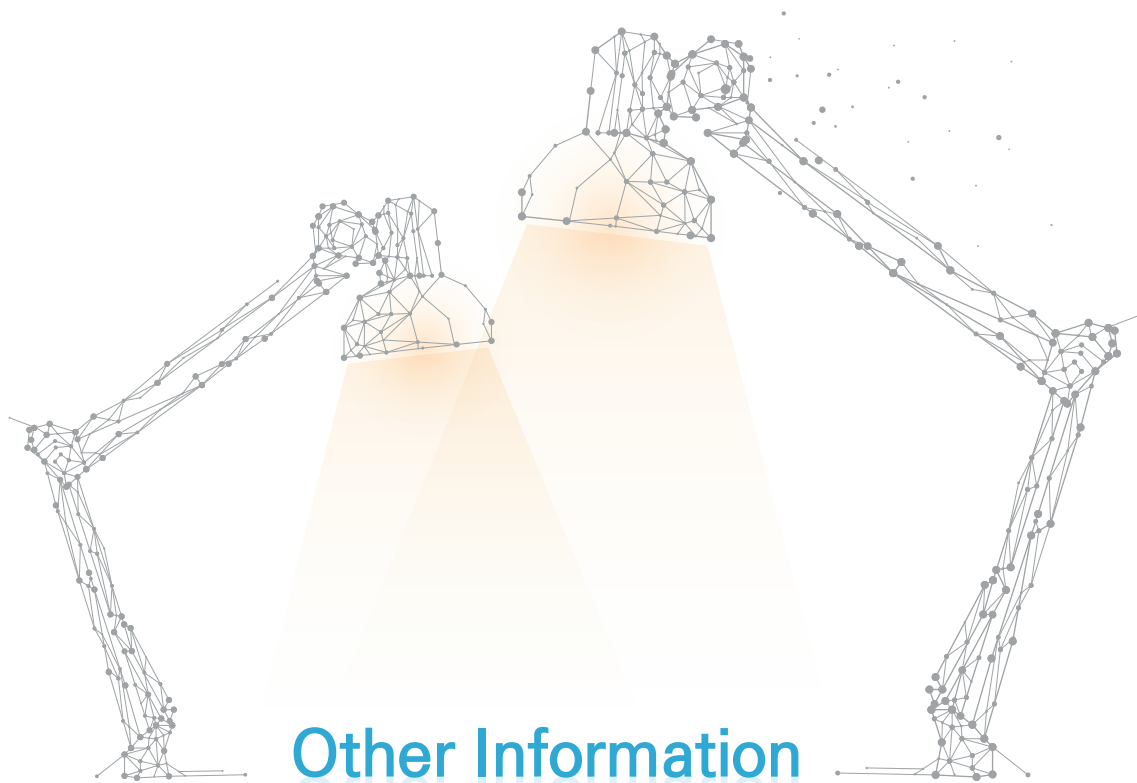

Other Information

Brake System : Electric Brake

Blade material : Fiberglass Reinforced Plastic

Maximum operation Temp : 60°C

Minimum operation Temp : -25°C

Life Time : 15years

Warranty : 2 years Warranty

Yawing System : YES

Static Wind Loads

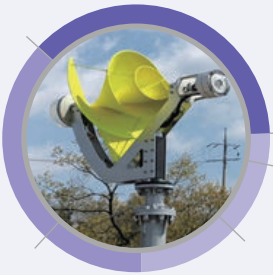

AWM-750D

The 0.75 meter diameter with a rated power of 100 w/h and a maximum of 150 w/h

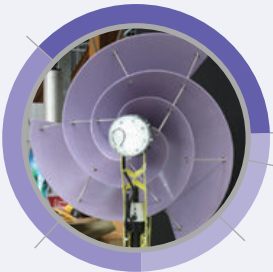

AWM-1500D

The 1.5 meter diameter with a rated power of 550 w/h and a maximum of 700 w/h



Hybrid Set up with PV

Combined Wind and Solar Energy Systems



Customizable

Customized products are the one which you can change according to you. In which there is the involvement of the customer in the design of the product.

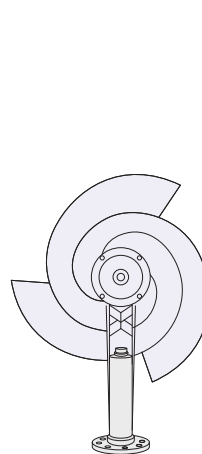

AWM-750D

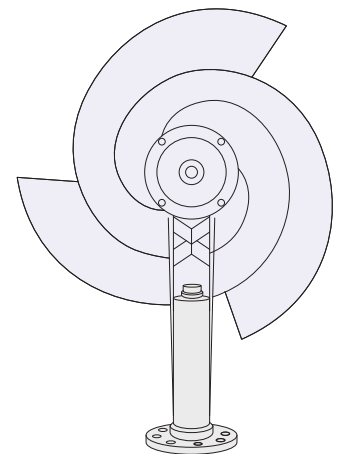

AWM-1500D

Division	AWM-750D	AWM-1500D	Unit
Air Density	1.2754	1.2754	kg/m ³
Drag coefficient	0.9	0.9	#
Gust factor	1.5	1.5	#
Maximum windspeed	52.5	52.5	m/s
Cross Area	0.318	1.299	m ²
Maximum Wind Force	755.6	3082.1	Newton

Part Description

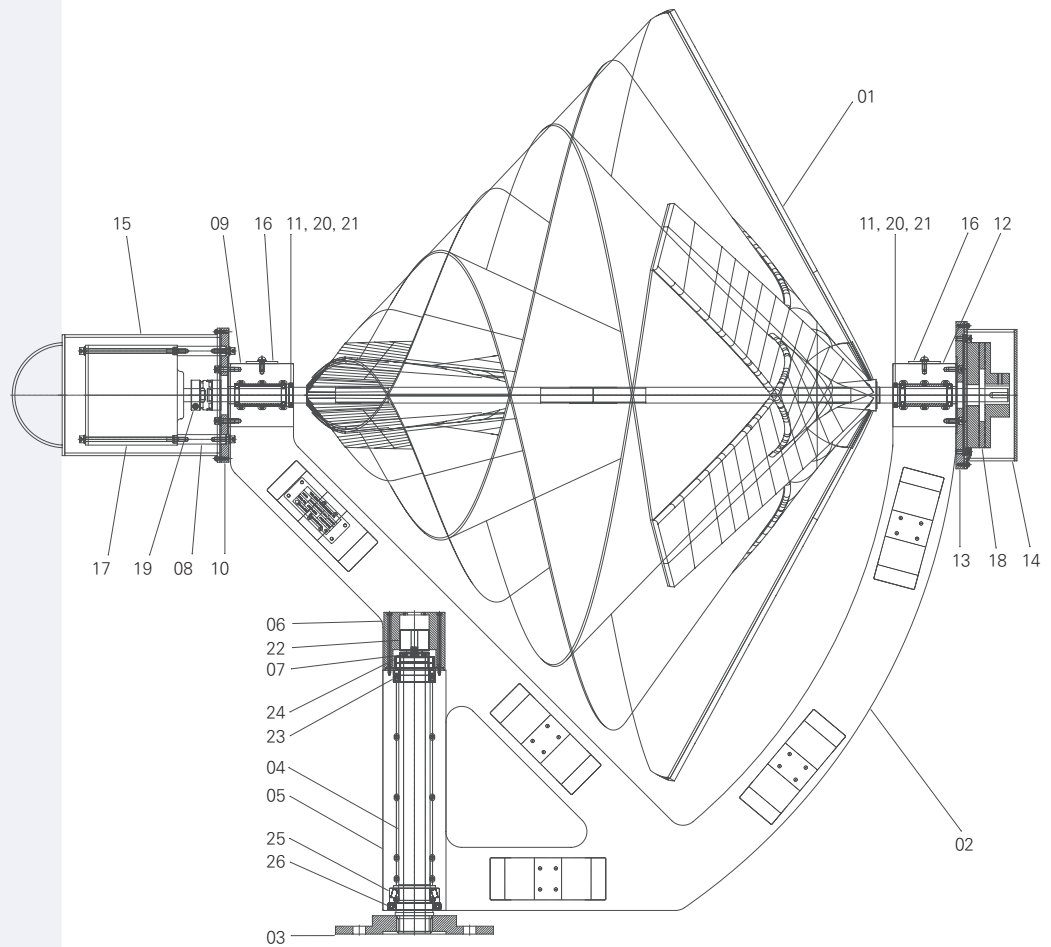

Number	Description
1	1.5m AWM Blade
2	Frame
3	Base Plate
4	Yawing Shaft
5	Yawing Shaft Cover
6	Yawing Neck Cover
7	Slip-ring Cover
8	Generator Fixing Shaft
9	Bearing Housing-1
10	Generator Plate
11	Bearing Spacer
12	Bearing Housing-2
13	Brake Plate

Number	Description
14	Brake Cover
15	Generator Cover
16	JIG Plate
17	Generator
18	Brake
19	Coupling
20	Bearing
21	Retainer
22	Slip-ring
23	Bearing
24	Lock Nut
25	Bearing
26	Retainer



Connection Methods

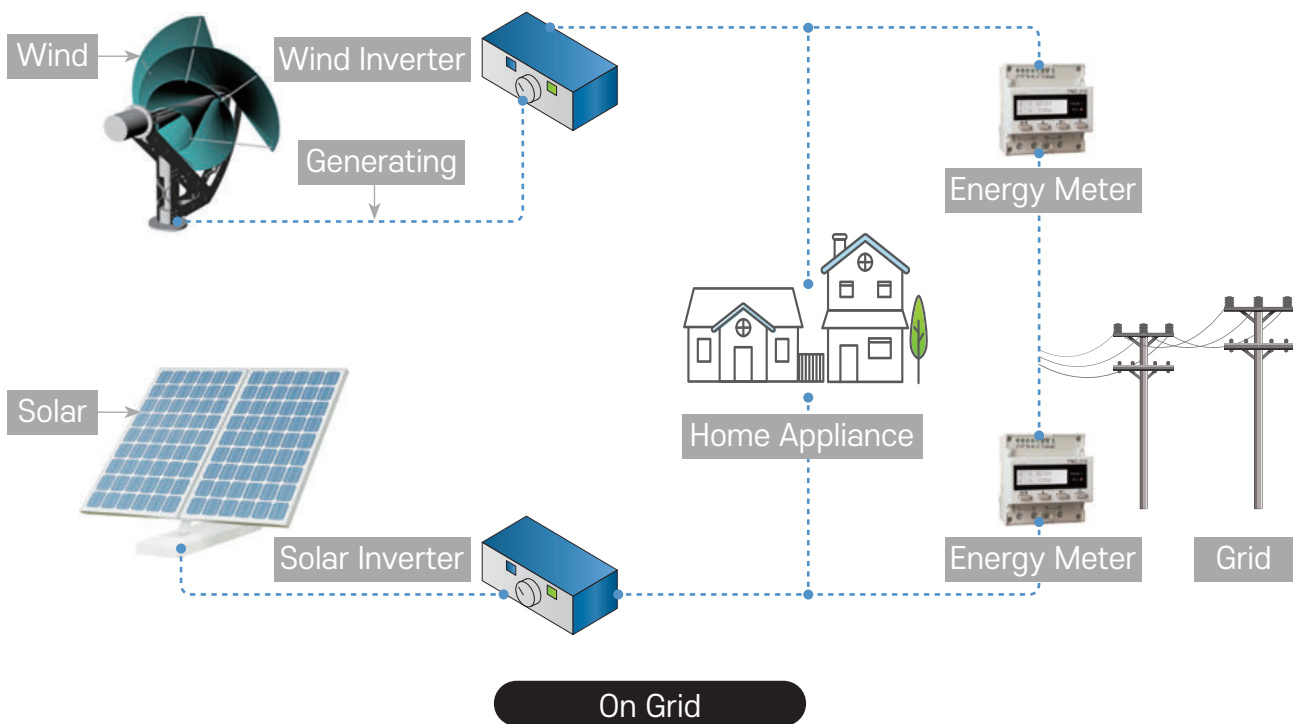
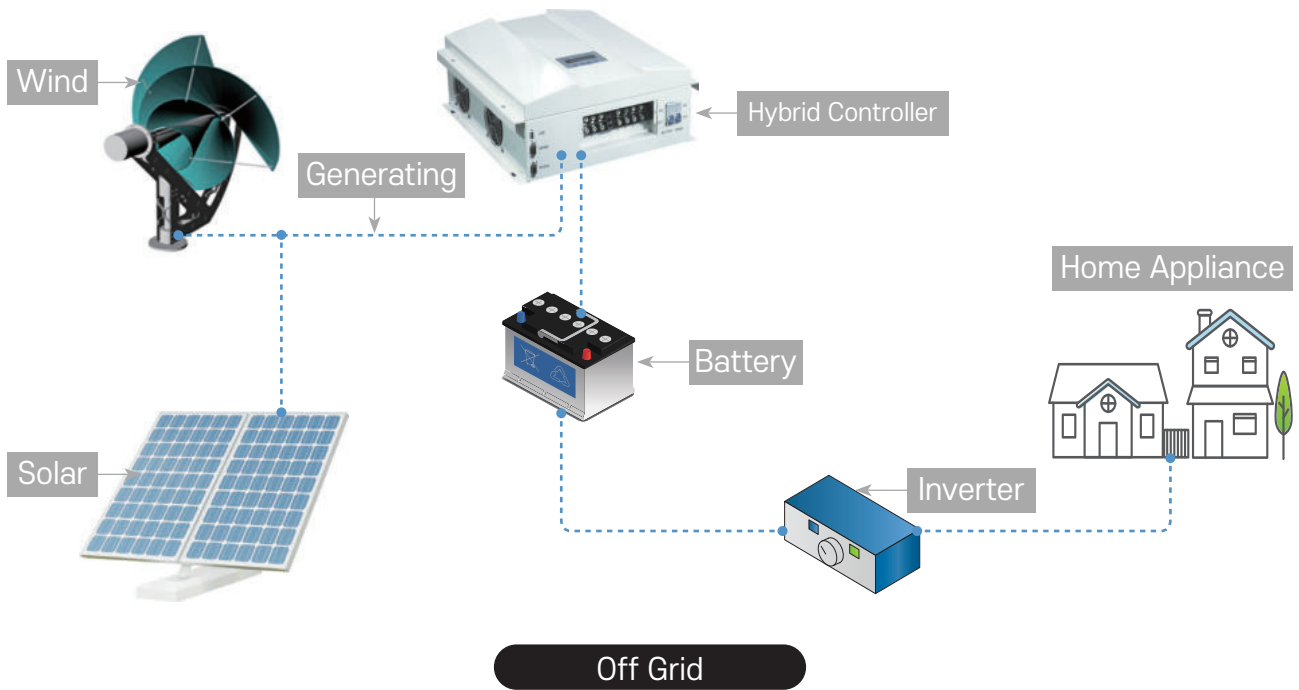

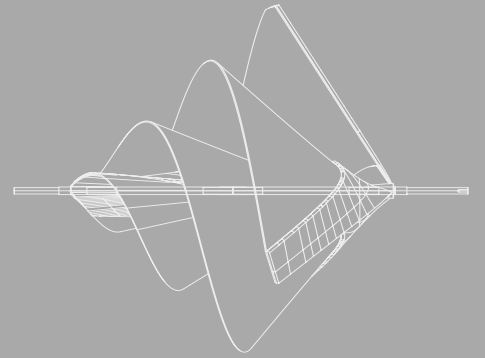

Global Track Record



Netherlands

Poland



UAE



Spain



Curacao





Video Link

1. International AWM Project

Introduction to the AWM turbine and Esco RTS's international collaboration plans.



2. Fly by

Areal view by drone of the Incheon university field test.



3. Roof Top Installation

Installation of an hybrid system (AWM and solar panels) in the Dutch harbor of Rotterdam on the rooftop of an office.



4. High Wind Speed Survival test

Short impression of the high wind speed test performed at KCL



5. Field Test in Jeju

Short overview of the long term field test at Jeju island, with high winds and coastal weather conditions.



6. History of AWM

A short overview of the AWM history, with prototypes, windtunnel and field tests, exhibitions and export.



“Be inspired to take control of your future”

CREATIVITY INSPIRED



Text

Sales
RESPECT South Korea
info@thearchimedes.com

Head Office
RESPECT Co., Ltd
#303, Inno-Biz Park
1646 Yuseong-daero, Yuseong-gu
Daejeon, South Korea