

Introducing the Hillstone Future-Ready A-Series Next Generation Firewall



Integrative Cyber
Security

What's the New Reality for NGFW?

What's the New Reality for NGFW?

Performance becomes a bottleneck

Devices have to be more compact

Policy overload creates risk and complexity

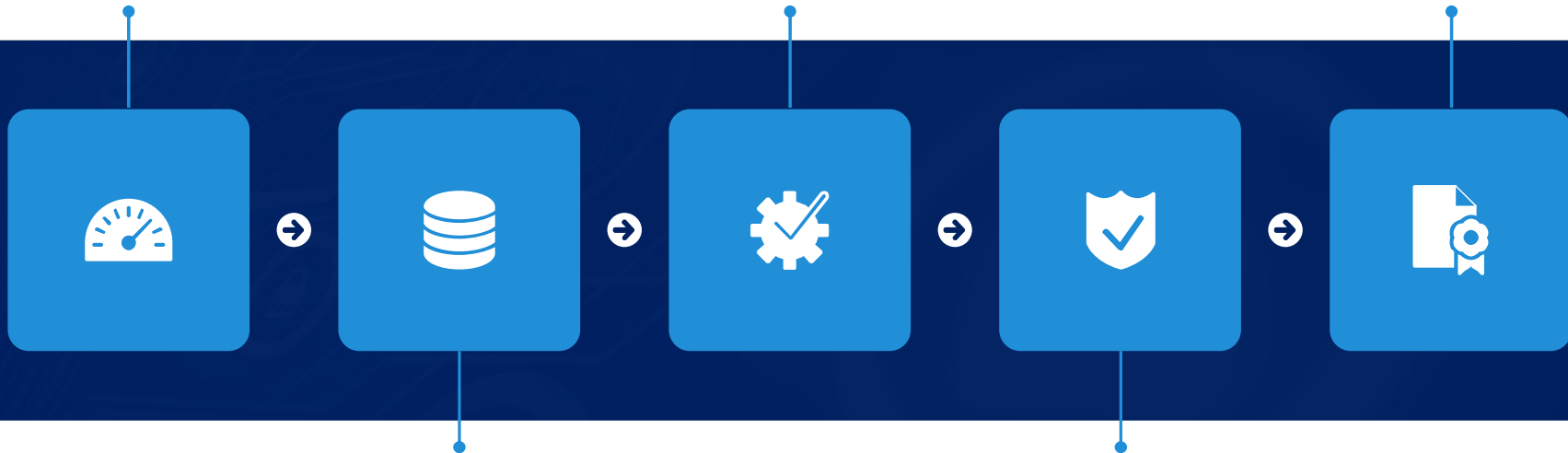

Storage space limits analytical capability

Security landscape is constantly changing dramatically

A Future-Ready NGFW

A Future-Ready NGFW



A-Series with Advance Hardware Architecture



**High
Performance**



**Excellent
Expansion
Capability**



**Advanced
Threat
Protection**



**Smart Policy
Operation**



**Multiple
Deployment
Scenarios**

The Hillstone A-Series: An Overview

- ▶ **Product name:**
SG-6000-A-Series NGFW



Product Highlights

- ▶ Built on a new generation of firewall hardware architecture.
- ▶ Excellent application security protection performance, high-density ports, large-capacity local and optional expansion storage, at a better TCO.
- ▶ Based on Hillstone innovative operating system, StoneOS.
- ▶ Hillstone's evolution in AI will continue to provide robust advanced threat detection in the future.

A Future-Ready NGFW - Extraordinary Performance Based on Advanced Hardware Architecture



A-Series with Advance Hardware Architecture



High Performance



Excellent Expansion Capability



Advanced Threat Protection



Smart Policy Operation



Multiple Deployment Scenarios

Advanced NGFW Hardware Architecture



Powerful computing foundation guarantees high performance



Friendly software ecology for third-party integration



SSL decryption hardware acceleration capability: alleviates CPU intensive tasks from servers



Hillstone proprietary hardware acceleration engine: significantly improves packet fast forwarding capability by offloading traffic from CPU



High-density interfaces, and front and rear-end air ventilation in compact design

Note: the SSL decryption hardware acceleration capability will be available via software upgrade in phase 2. A200(W)-IN series do NOT support hardware acceleration; the Hillstone proprietary hardware acceleration engine is only available for A6800-IN and A7600-IN.

Outstanding Hardware Design



SSL Decryption Hardware Acceleration

Free up more CPU resources

Defend against the threats of encrypted traffic with strong decryption capability



Compact Design

Small size, energy-saving:
Desktop or 1RU rackmount model

Possess high-density interfaces and power modules in all 1RU rackmount models



Front and Rear-end Air Ventilation

Improve heat-dissipation capability

Meet the heat-dissipating requirement of data center rack

Maintain good performance

Hillstone Proprietary Hardware Acceleration Engine



High Throughput

- Enable high-end models to cover the throughput requirements of high-traffic scenarios



Fast Packet Forwarding

- Free up CPU by offloading IPv4/IPv6 traffic, to process comprehensive security services



CPU Offload

- Ultra-low latency in packet forwarding within a few microseconds, fully meet the needs of latency-sensitive scenarios



High Performance Highlights & Values

High Firewall Throughput

- High firewall throughput up to **280 Gbps**
- Meet the high-traffic needs in scenarios like data centers

High Application-Layer Performance

- High IPS throughput up to **70 Gbps** with 2QSFP+ module
- High level of concurrent sessions up to **42 Million**
- Meet real-world network security needs

Powerful Fast-forward Capability

- Ultra-low latency in packet forwarding within a few **microseconds**
- Meet the requirements of latency-sensitive scenarios

A Future-Ready NGFW - Excellent Expansion Capability



A-Series with Advance Hardware Architecture



**High
Performance**



**Excellent
Expansion
Capability**

Interface & Storage



**Advanced
Threat
Protection**



**Smart Policy
Operation**



**Multiple
Deployment
Scenarios**

Excellent Access Capability with Advanced Interface



Interface Highlights



- ▶ Large amount of fixed, high-speed I/O ports (high-density up to 4 QSFP28)
- ▶ A3700-IN/A3800-IN/A5x00-IN/A5x55-IN/A6800-IN/A7600-IN models support expansion
- ▶ Bypass pair in A1100-IN/A2x00-IN/A3x00-IN/A5x00-IN/A5x55-IN rackmount models
- ▶ All rackmount models provide two USB3.0 interfaces

Benefits



- ▶ NGFW can also act as a switch and router; fast data rate support
- ▶ Throughput increase by adding expansion module :
A3700-IN: 20 Gbps -> 30 Gbps, A3800-IN: 20 Gbps -> 40 Gbps,
A5100-IN/A5155-IN: 25 Gbps -> 50 Gbps, A5200-IN/A5255-IN: 32 Gbps -> 65 Gbps, A5500-IN/A5555-IN: 40 Gbps -> 80 Gbps
A5600: 60 Gbps -> 85 Gbps, A5800-IN: 80 Gbps -> 95 Gbps, A7600: 280 Gbps -> 320 Gbps
- ▶ Bypass capability ensures business continuity
- ▶ 4G/5G access capability

Value



- ▶ Cost Savings
- ▶ Increased Performance
- ▶ High Availability
- ▶ Future Ready

Platform	A200-IN	A200W-IN	A1000-IN	A1100-IN	A2000-IN	A2600-IN	A2700-IN	A2800-IN	A3000-IN	A3600-IN	A3700-IN	A3800-IN	A5100-IN	A5155-IN	A5200-IN	A5255-IN	A5500-IN	A5555-IN	A5600-IN	A5800-IN	A6800-IN	A7600-IN		
Fixed I/O Ports	5 * GE, 1 * SFP	5 * GE, 1 * SFP	4 * GE	8 * GE(RJ45) (1 bypass pair)	8 * GE(RJ45) (1 bypass pair)	8 * GE(RJ45) (1 bypass pair)	2 * SFP+ 8 * GE	2 * SFP+ 8 * GE	2 * 10GE(SFP+) 8 * GE(SFP) 16 * GE(RJ45) (2 bypass pair)	2 * 10GE(SFP+) 8 * GE(SFP) 16 * GE(RJ45) (2 bypass pair)	2 * 10GE(SFP+) 8 * GE(SFP) 16 * GE(RJ45) (2 bypass pair)	2 * 10GE(SFP+) 8 * GE(SFP) 16 * GE(RJ45) (2 bypass pair)	6 * SFP+, 16 * SFP, 8 * GE (2 bypass)	2 * QSFP+, 16 * SFP+, 8 * GE (4 bypass)	6 * SFP+, 16 * SFP, 8 * GE (2 bypass)	2 * QSFP+, 16 * SFP+, 8 * GE (4 bypass)	6 * SFP+, 16 * SFP, 8 * GE (2 bypass)	2 * QSFP+, 16 * SFP+, 8 * GE (4 bypass)	2 * QSFP+, 16 * SFP+, 8 * GE (4 bypass)	2 * QSFP+, 16 * SFP+, 8 * GE (4 bypass)	4 * QSFP28 (or 2 * QSFP+)	4 * QSFP28 (or 2 * QSFP+)	4 * QSFP28 (or 2 * QSFP+)	
Wi-Fi	N/A	IEEE802.11a/b/g/n/ac	N/A	N/A	N/A	N/A	N/A	N/A	N/A	N/A	N/A	N/A	N/A	N/A	N/A	N/A	N/A	N/A	N/A	N/A	N/A	N/A	N/A	
Expansion Slots	-	-	-	-	-	-	-	-	-	-	1	1	1	1	1	1	1	1	1	1	1	1	1	
Expansion Module Option	-	-	-	-	-	-	-	-	-	-	IOC-A-4SFP+-IN, IOC-A-2QSFP+-IN, IOC-A-2MM-BE-IN, IOC-A-2SM-BE-IN	IOC-A-4SFP+-IN, IOC-A-2QSFP+-IN, IOC-A-2MM-BE-IN, IOC-A-2SM-BE-IN	IOC-A-4SFP+-IN, IOC-A-2QSFP+-IN, IOC-A-2MM-BE-IN, IOC-A-2SM-BE-IN	IOC-A-4SFP+-IN, IOC-A-2QSFP+-IN, IOC-A-2MM-BE-IN, IOC-A-2SM-BE-IN	IOC-A-4SFP+-IN, IOC-A-2QSFP+-IN, IOC-A-2MM-BE-IN, IOC-A-2SM-BE-IN	IOC-A-4SFP+-IN, IOC-A-2QSFP+-IN, IOC-A-2MM-BE-IN, IOC-A-2SM-BE-IN	IOC-A-4SFP+-IN, IOC-A-2QSFP+-IN, IOC-A-2MM-BE-IN, IOC-A-2SM-BE-IN	IOC-A-4SFP+-IN, IOC-A-2QSFP+-IN, IOC-A-2MM-BE-IN, IOC-A-2SM-BE-IN	IOC-A-4SFP+-IN, IOC-A-2QSFP+-IN, IOC-A-2MM-BE-IN, IOC-A-2SM-BE-IN	IOC-A-4SFP+-IN, IOC-A-2QSFP+-IN, IOC-A-2MM-BE-IN, IOC-A-2SM-BE-IN	IOC-A-4SFP+-IN, IOC-A-2QSFP+-IN, IOC-A-2MM-BE-IN, IOC-A-2SM-BE-IN	IOC-A-4SFP+-IN, IOC-A-2QSFP+-IN, IOC-A-2MM-BE-IN, IOC-A-2SM-BE-IN	IOC-A-4SFP+-IN, IOC-A-2QSFP+-IN, IOC-A-2MM-BE-IN, IOC-A-2SM-BE-IN	IOC-A-4SFP+-IN, IOC-A-2QSFP+-IN, IOC-A-2MM-BE-IN, IOC-A-2SM-BE-IN
USB	1 * USB2.0	1 * USB2.0	2 * USB3.0	2 * USB3.0	2 * USB3.0	2 * USB3.0	2 * USB3.0	2 * USB3.0	2 * USB3.0	2 * USB3.0	2 * USB3.0	2 * USB3.0	2 * USB3.0	2 * USB3.0	2 * USB3.0	2 * USB3.0	2 * USB3.0	2 * USB3.0	2 * USB3.0	2 * USB3.0	2 * USB3.0	2 * USB3.0	2 * USB3.0	

Better Analytics and Visibility with Increased Storage



eMMC
(4/8/64GB)
Standard



eMMC
(8/64GB)
Standard



Hard Drive
(256GB to 1.92TB)
Optional

- ▶ Store configuration files, signature databases, images, etc.
 - ▶ Store network/event/configuration logs, reports
 - ▶ Cloud Sandbox logs or threat logs should be sent to HSM, HSA or CloudView for longer term storage
 - ▶ The storage size of each module is specified by the system and cannot be configured
- ▶ eMMC stores:
 - › configuration files, signature databases, images, etc.
 - ▶ Hard drive stores:
 - › Network/event/configuration/threat/cloud sandbox logs (up to 6 months)
 - › More comprehensive reports
 - ▶ More analytics capability, including IPS threat packet capture
 - ▶ The storage size of each module is specified by the system by default, and it can be configured

Platform	A200-IN	A200W-IN	A1000-IN	A1100-IN	A2000-IN	A2600-IN	A2700-IN	A2800-IN	A3000-IN	A3600-IN	A3700-IN	A3800-IN	A5100-IN	A5155-IN	A5200-IN	A5255-IN	A5500-IN	A5555-IN	A5600-IN	A5800-IN	A6800-IN	A7600-IN
Local Storage	4 GB	4 GB	8 GB	8 GB	8 GB	8 GB	8 GB	8 GB	8 GB	8 GB	8 GB	8 GB	64 GB	64 GB	64 GB	64 GB	64 GB	64 GB	64 GB	64 GB	64 GB	64 GB
Expansion Storage Options	0	0	256 GB SSD	256 GB SSD	480GB / 960GB / 1.92TB SSD	480GB / 960GB / 1.92TB SSD	480GB / 960GB / 1.92TB SSD	480GB / 960GB / 1.92TB SSD	480GB / 960GB / 1.92TB SSD	480GB / 960GB / 1.92TB SSD	480GB / 960GB / 1.92TB SSD	480GB / 960GB / 1.92TB SSD	480GB / 960GB / 1.92TB SSD	480GB / 960GB / 1.92TB SSD	480GB / 960GB / 1.92TB SSD	480GB / 960GB / 1.92TB SSD	480GB / 960GB / 1.92TB SSD	480GB / 960GB / 1.92TB SSD	480GB / 960GB / 1.92TB SSD	480GB / 960GB / 1.92TB SSD	480GB / 960GB / 1.92TB SSD	480GB / 960GB / 1.92TB SSD

Longer Log Storing Time
Deeper Analytics
Richer Reports
Better Visibility

A Future-Ready NGFW - Advanced Threat Protection



A-Series with Advance Hardware Architecture



High
Performance



Excellent
Expansion
Capability



Advanced
Threat
Protection



Smart Policy
Operation



Multiple
Deployment
Scenarios

Interface & Storage

Advanced Threat Protection for Known and Unknown Malware Hillstone NETWORKS

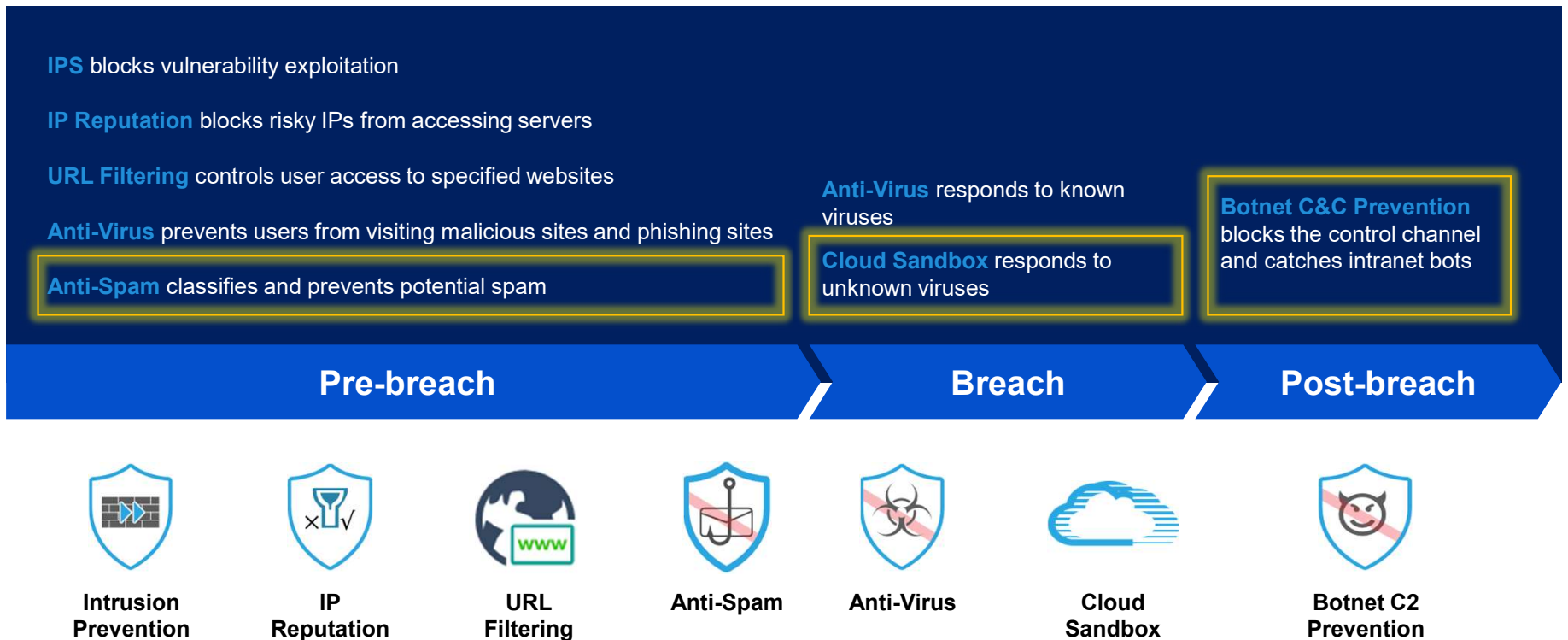

Anti-Spam for Real-time Spam Classification and Prevention

Global Spam Collection (Partner)

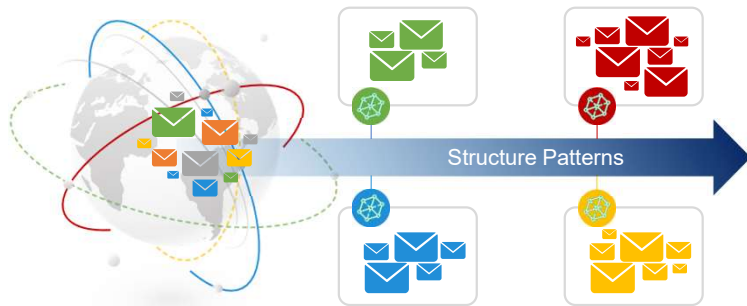

Cloud-Based Spam Database

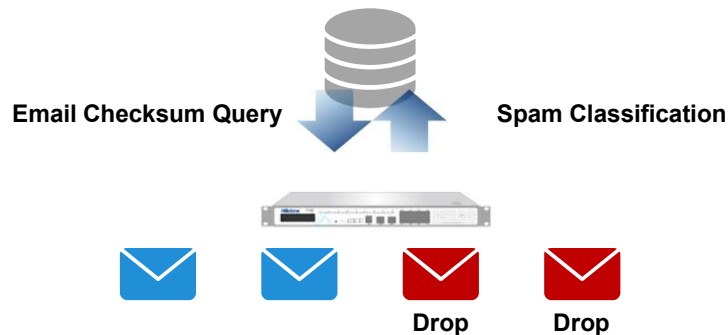

Key Features

- Real-time Spam Classification and Prevention
- Supported Spam classification: Confirmed Spam, Suspected Spam, Bulk Spam, Valid Bulk
- Supports encrypted traffic spam detection
- Works on both SMTP and POP3 email protocols
- Inbound and outbound detection
- Whitelisting permits emails from trusted domains
- Support multiple languages, formats, or content of the message

Cloud Sandbox for Malicious File Detection and Prevention

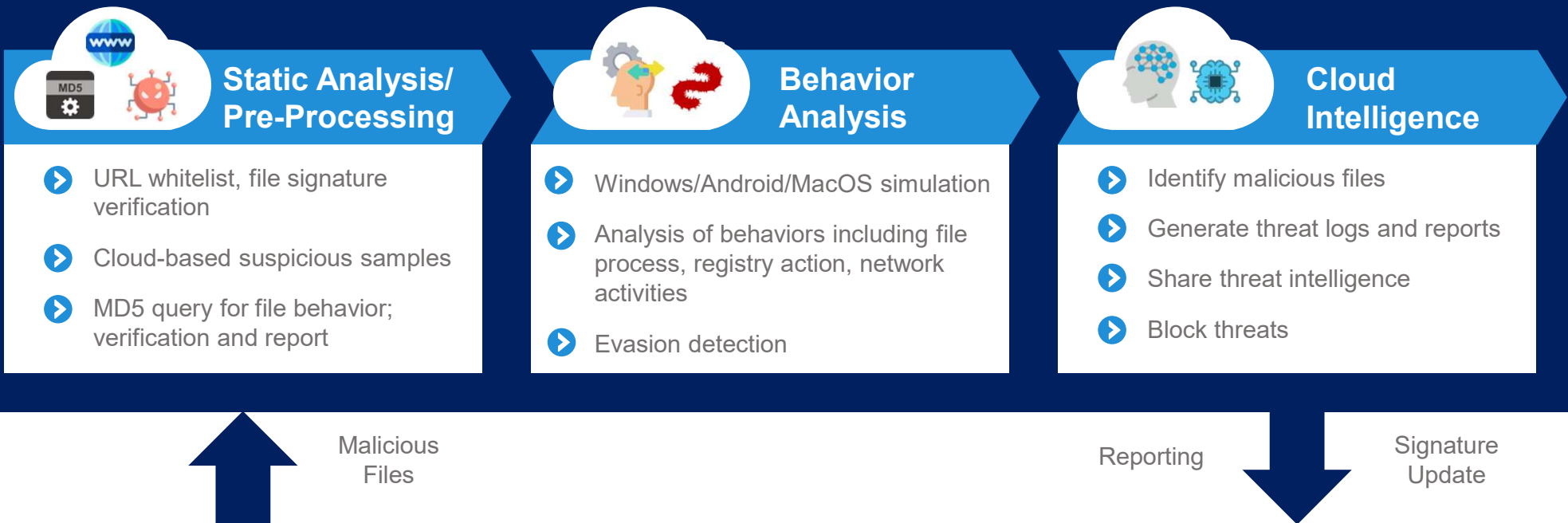

Complete Botnet C&C Prevention

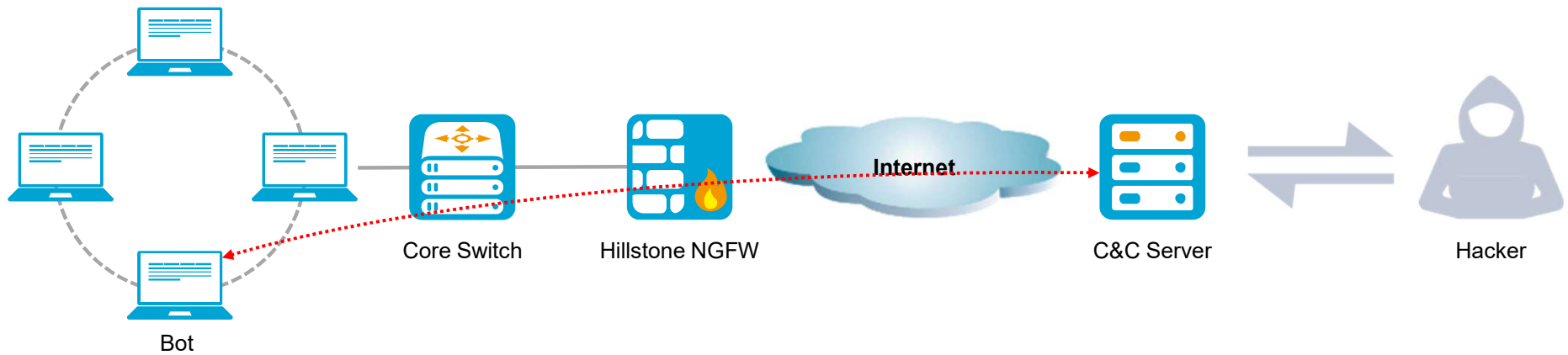

C2 Address Database

DNS Sinkhole Detection

DNS Tunnel Detection

DGA Domain Detection

ML-based Intelligent Threat Detection and Protection

Encrypted Traffic Detection

DoS/DDoS Defense

DGA Detection

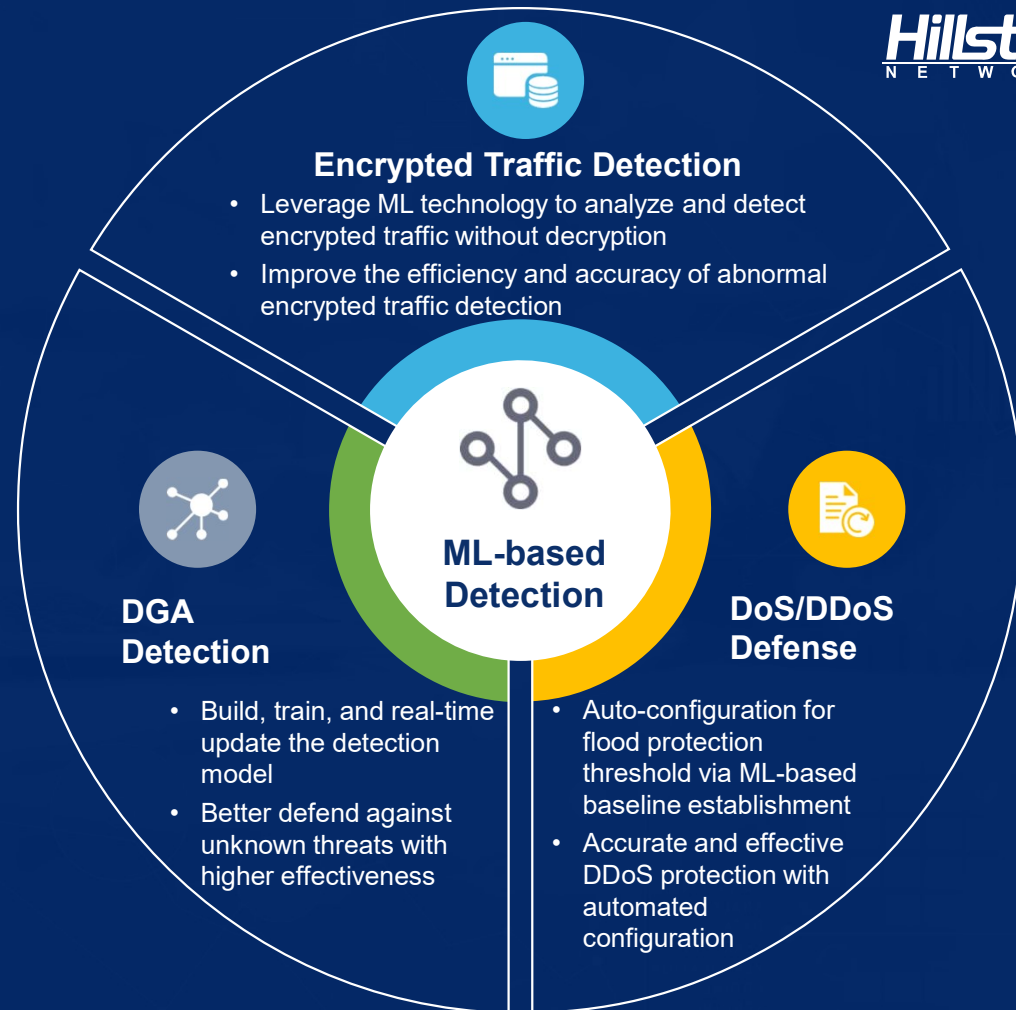

A Future-Ready NGFW - Smart Policy Operation



A-Series with Advance Hardware Architecture



High Performance



Excellent Expansion Capability



Advanced Threat Protection



Smart Policy Operation



Multiple Deployment Scenarios

Smart Policy Operation

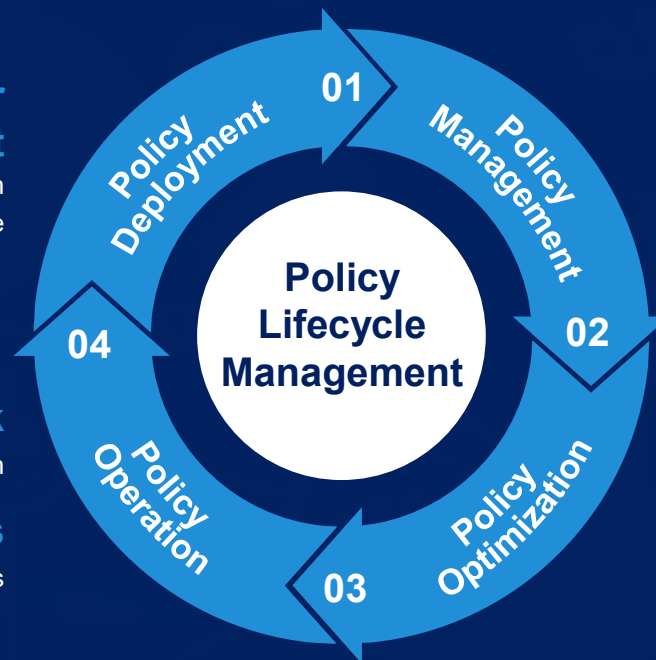

Automated User Policy Deployment

Radius Dynamic Authorization
Automatically issue user policy via CoA message

Policy Redundancy Check

Discover redundant FW/NAT policies for deletion

Policy Analysis

Adjust policies by observing hit counts and hit trends

Policy Group

Efficient policy management based on business requirements

Aggregate Policy

Combining a set of individualized policies into one unified policy

Millions of Mini Policy

Ensures consistent policy enforcement on all firewall security features with extreme scalability

Policy Assistant

Refine a general policy into a granular policy

Easy Deployment

Rapid Launch of New Services

Dynamic Policy Adjustment

Increased Efficiency & Reduced Overhead

A Future-Ready NGFW - Multiple Deployment Scenarios



A-Series with Advance Hardware Architecture



**High
Performance**



**Excellent
Expansion
Capability**



**Advanced
Threat
Protection**



**Smart Policy
Operation**



**Multiple
Deployment
Scenarios**

Zero Trust Network Access (ZTNA) Solution

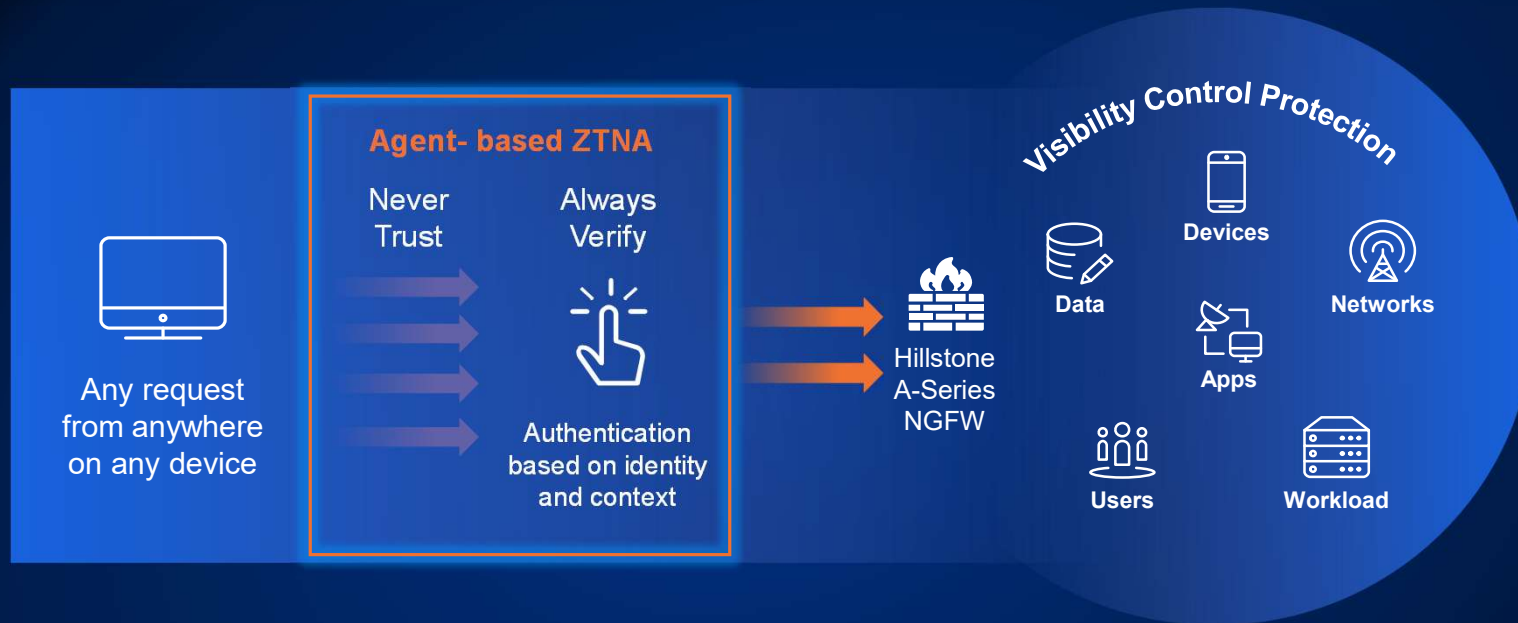

Highlights

- ▶ Identity-Based, Least-Privileged Secure Access
- ▶ Context-Aware, Adaptive Access Control
- ▶ Centralized and Efficient Management
- ▶ Award-Winning Enterprise-Grade Security Foundation

NGFW Fits into Hillstone Solutions



The integration of NGFW and other Hillstone security products enables multiple Hillstone solutions

SD-WAN solution

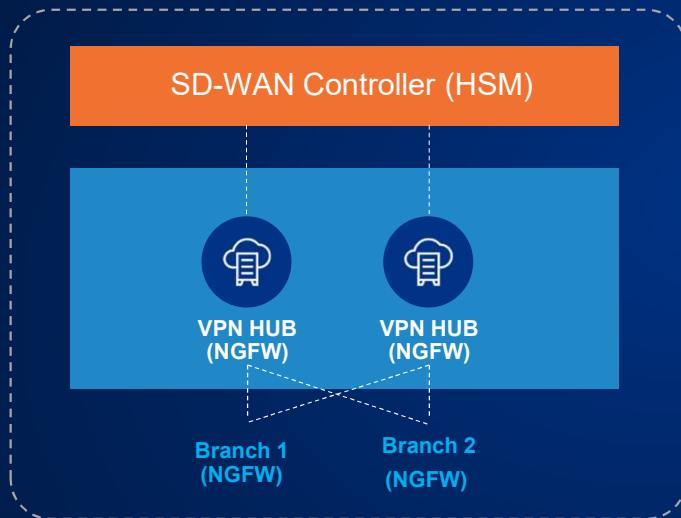

▶ Efficient centralized management for multiple NGFW

XDR solution

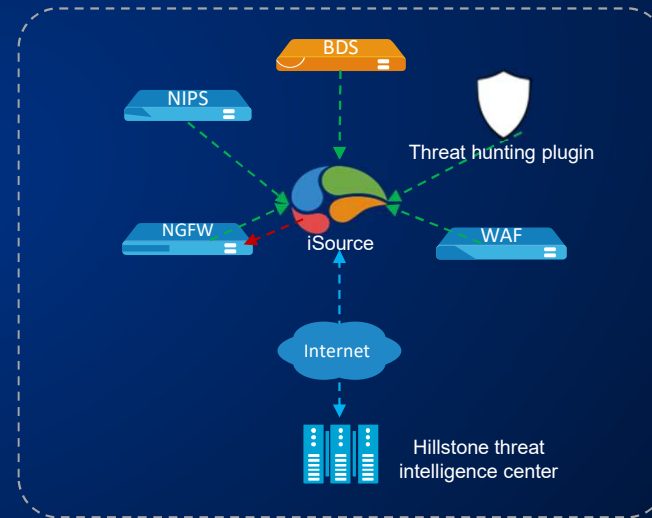

▶ Promote joint protection against new types of attacks through integration with iSource and deployment in XDR solution

Enable Multiple Use Cases with High Performance

Network Edge



- › Powerful network security capabilities to defend against more advanced threats
- › Expedited execution of various security services with strong CPU power

Data Center



- › High throughput to handle massive volumes of traffic in data center
- › Twin-mode HA maintains high reliability of data center communication

SD-WAN

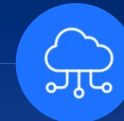

- › High security performance of built-in NGFW brings faster, lower-cost and secure local internet connections at remote location

Remote Access with ZTNA



- › Context and identity-aware, and least-privileged secure access control guarantee the security and effectiveness for the remote access

Fast, Effective, Efficient Future-Ready Security Protection with Hillstone A-Series NGFW



High Security Performance

Leading application layer performance meets real network security needs



Complete Advanced Threat Detection and Prevention

Protect against known and unknown threats



Smart and Automated Operation

Security operations made easy



Expansion as Needed

High-density ports ensure excellent access capability
Large storage options allow for deeper analytics and better visibility



Multiple Solutions and Deployment Scenarios

Enables multiple Hillstone solutions and deployments scenarios with high performance

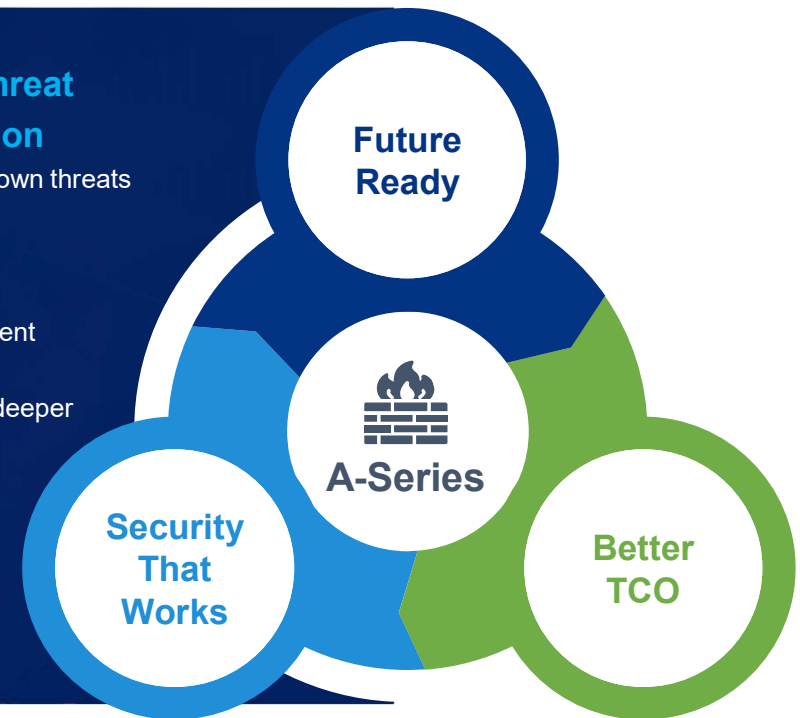

Hillstone Networks is Your Trusted Security Partner



Figure 1: Magic Quadrant for Network Firewalls



Source: Gartner (December 2022)



Gartner

*A Visionary in the
Gartner Magic Quadrant
for Network Firewalls*

8 Consecutive
Years

*in Gartner Magic
Quadrant for Network
Firewalls*

The Product Introduction

A-Series Product Positioning



The Hillstone A-Series NGFW: Specifications



	<i>Desktop</i>			
	SG-6000-A200-IN	SG-6000-A200W-IN	SG-6000-A1000-IN	SG-6000-A1100-IN
Firewall Throughput	1 Gbps	1 Gbps	4 Gbps	5 Gbps
Maximum Concurrent Sessions	300,000	300,000	300,000	300,000
New Sessions/s	15,000	15,000	48,000	48,000
IPS Throughput	610 Mbps	610 Mbps	3.4 Gbps	3.7 Gbps
NGFW Throughput	400 Mbps	400 Mbps	1.5 Gbps	1.7 Gbps
Threat Protection Throughput	200 Mbps	200 Mbps	800 Mbps	800 Mbps
AV Throughput	550 Mbps	550 Mbps	1.8 Gbps	2.0 Gbps
IPsec VPN Throughput	620 Mbps	620 Mbps	2,500 Mbps	2,700 Mbps
SSL Proxy Throughput	15 Mbps	15 Mbps	250 Mbps	250 Mbps
Virtual Systems (Default/Max)	N/A	N/A	N/A	N/A
SSL VPN User Number	128	128	128	128
IPsec Tunnel Number	2,000	2,000	2,000	2,000
Management Ports	1 * Console Port, 1 * USB 2.0 Port	1 * Console Port, 1 x USB 2.0 Port	1 * Console Port, 2 * USB3.0 Ports	1 * Console Port, 2 * USB3.0 Ports, 1 * MGT Port (RJ45)
Fixed I/O Ports	1 * SFP, 5 * GE	1 * SFP, 5 * GE	4 * GE	8 * GE (including 1 bypass pair)
Wi-Fi	N/A	IEEE802.11a/b/g/n/ac	N/A	N/A
Available Slots for Expansion Modules	N/A	N/A	NA	NA
Expansion Module Option	N/A	N/A	NA	NA
Twin-mode HA	N/A	N/A	NA	NA
Local Storage	4 GB	4 GB	8 GB	8 GB
Expansion Storage Options	N/A	N/A	256 GB SSD	256 GB SSD
Power Specification	14W, Single AC (default)	14W, Single AC (default)	30W, Single AC	30W, Single AC
Power Supply	AC 100-240V, 50/60 Hz	AC 100-240V, 50/60 Hz	AC 100-240V, 50/60 Hz	AC 100-240V, 50/60 Hz
Form Factor	Desktop	Desktop	Desktop	Desktop
Weight	2.2 lb (0.6 kg)	2.2 lb (0.6 kg)	3.1 lb (1.4 kg)	3.1 lb (1.4 kg)
Temperature	32-104°F (0-40°C)	32-104°F (0-40°C)	32-104°F (0-40°C)	32-104°F (0-40°C)
Relative Humidity	10-95% non-condensing	10-95% non-condensing	10-95% non-condensing	10-95% non-condensing

A200 Front and Rear Panel

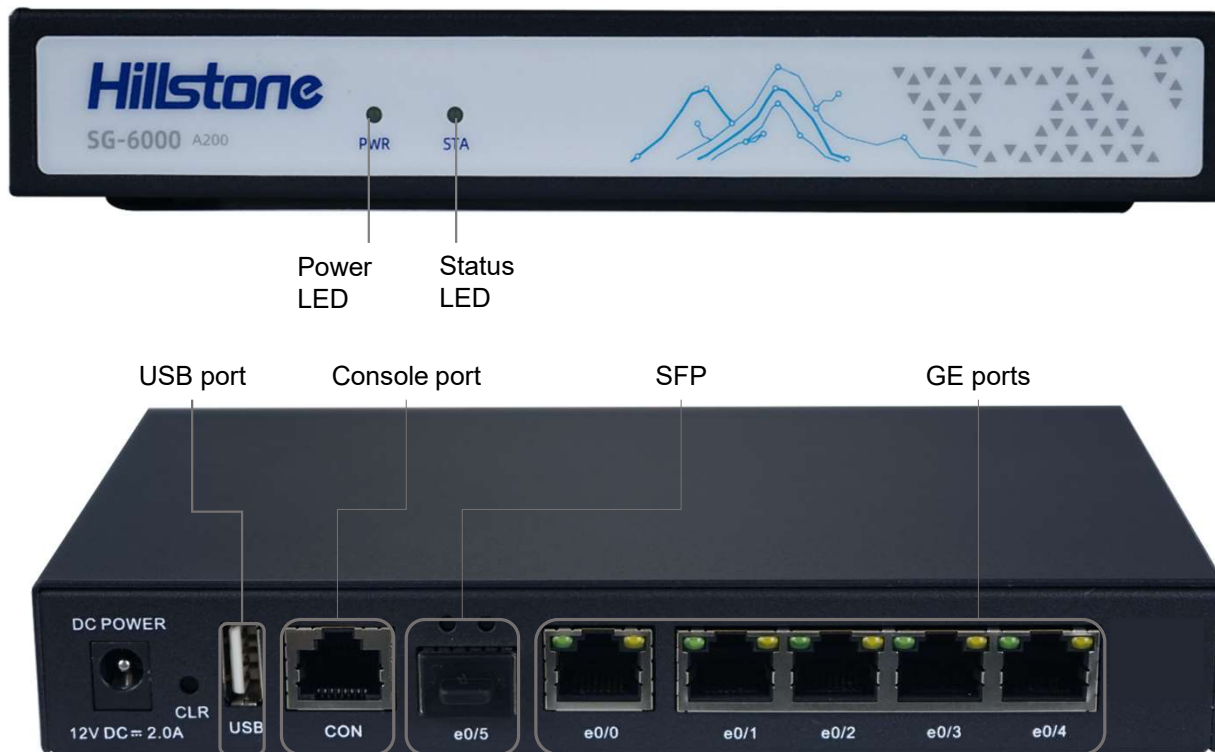

A200W Front and Rear Panel



Power LED
Status LED
WLAN LED

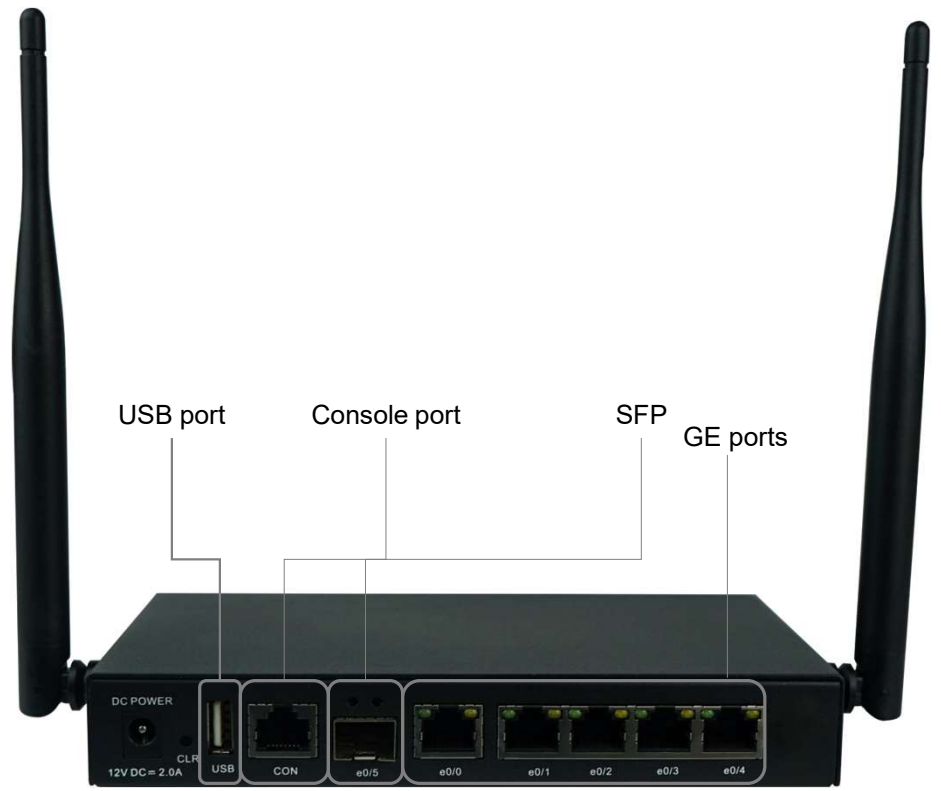

USB port
Console port
SFP
GE ports

A1000 Front and Rear Panel

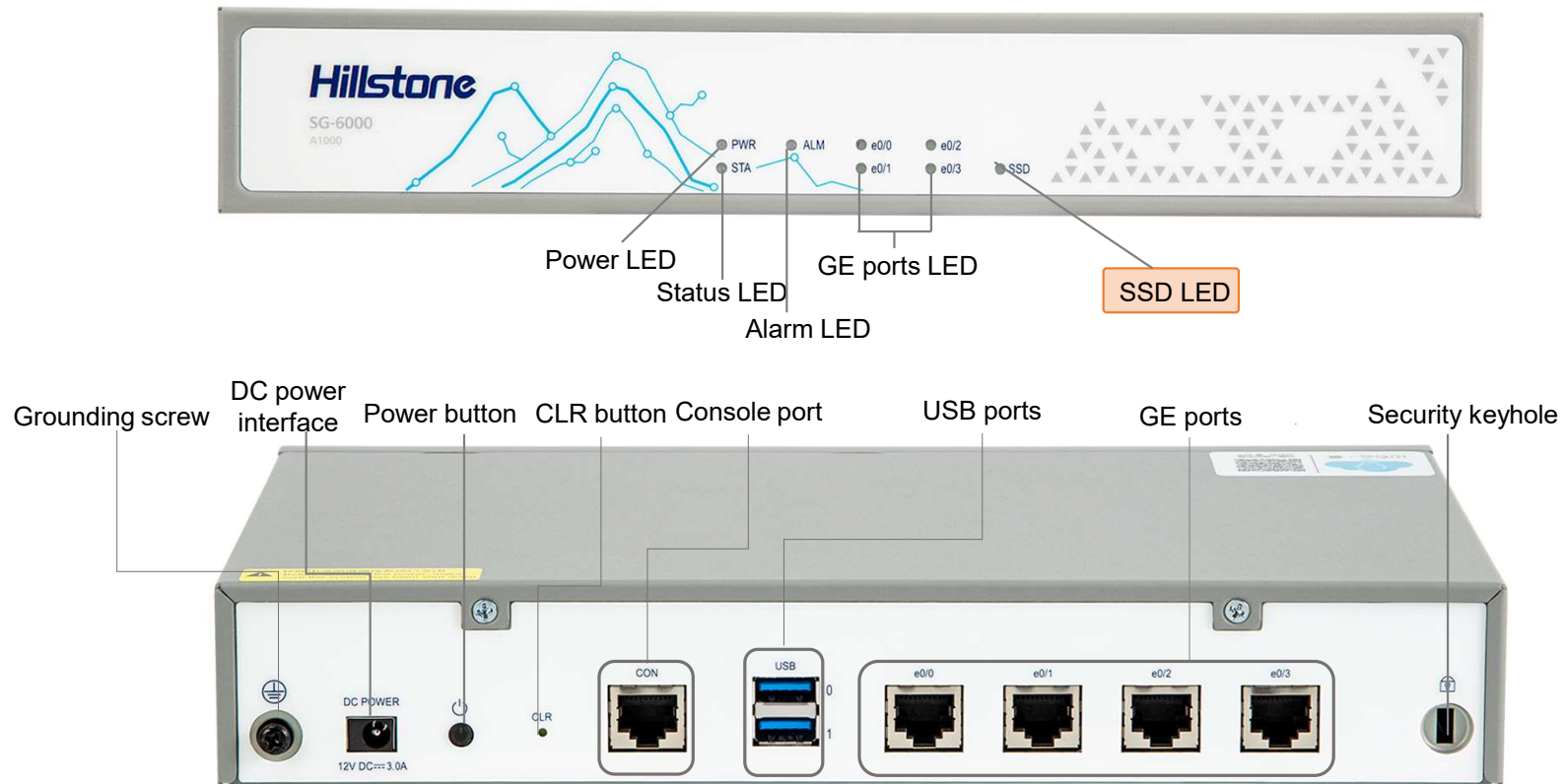

A1100 Front and Rear Panel

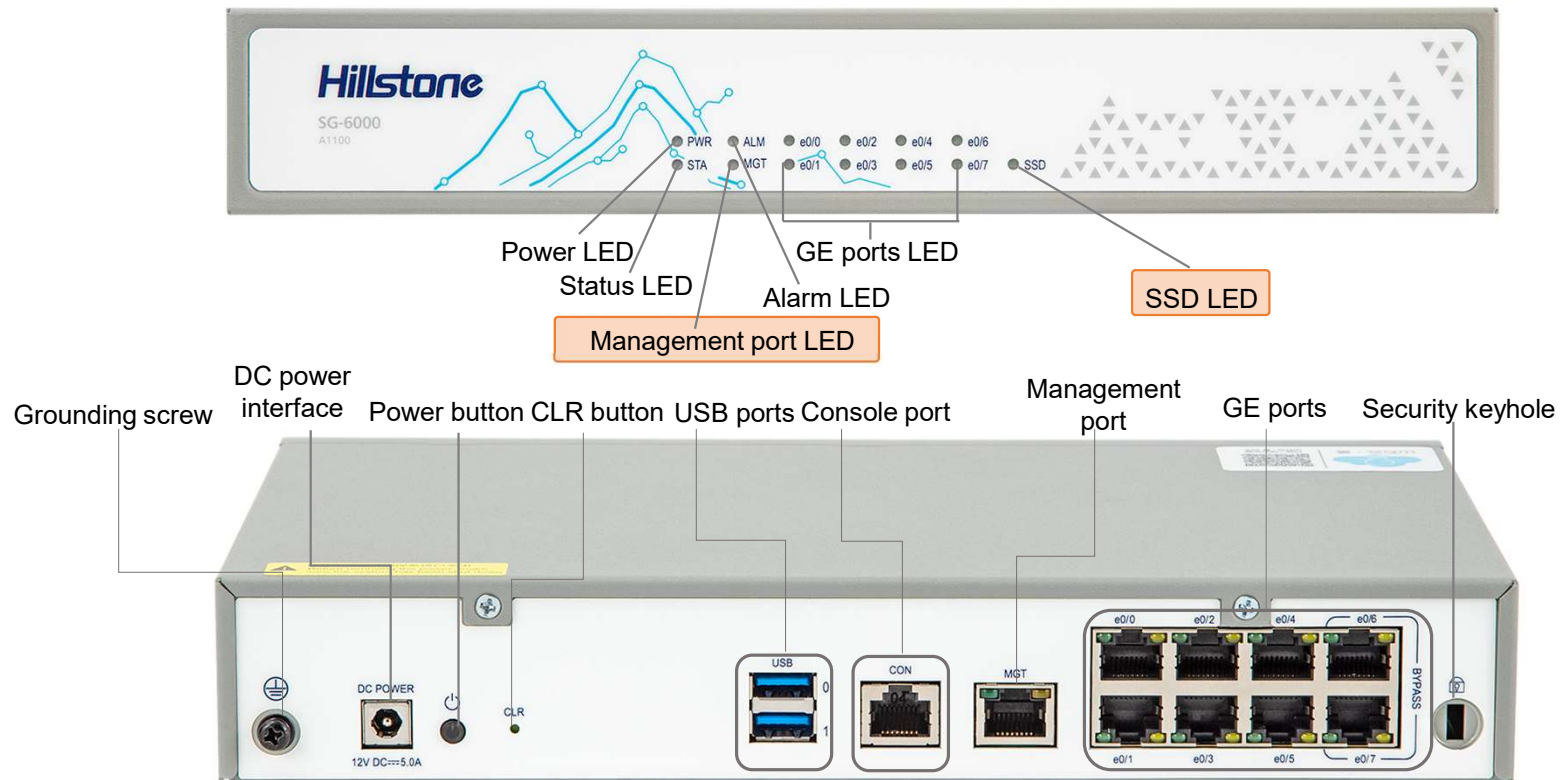

The Hillstone A-Series NGFW: Specifications



	Rackmount			
	SG-6000-A2000-IN	SG-6000-A2600-IN	SG-6000-A2700-IN	SG-6000-A2800-IN
Firewall Throughput	5 Gbps	5 Gbps	10 Gbps	16 Gbps
Maximum Concurrent Sessions	1 Million	1.2 Million	1.5 Million	1.8 Million
New Sessions/s	48,000	120,000	130,000	130,000
IPS Throughput	3.2 Gbps	4.5 Gbps	5 Gbps	8 Gbps
NGFW Throughput	1.7 Gbps	2.5 Gbps	3 Gbps	4.5 Gbps
Threat Protection Throughput	800 Mbps	1.8 Gbps	2 Gbps	2.8 Gbps
AV Throughput	2.0 Gbps	3.7 Gbps	4.2 Gbps	4.2 Gbps
IPsec VPN Throughput	2,700 Mbps	3,000 Mbps	5 Gbps	5.5 Gbps
SSL Proxy Throughput	250 Mbps	750 Mbps	800 Mbps	800 Mbps
Virtual Systems (Default/Max)	1/5	1/5	1/5	1/5
SSL VPN User Number	1,000	2,000	4,000	4,000
IPsec Tunnel Number	4,000	6,000	6,000	6,000
Management Ports	1 * Console Port, 2 * USB3.0 Ports, 1 * MGT Port (RJ45)	1 * Console Port, 2 * USB3.0 Ports, 1 * MGT Port (RJ45)	1 * Console Port, 2 * USB3.0 Ports, 1 * MGT Port (RJ45)	1 * Console Port, 2 * USB3.0 Ports, 1 * MGT Port (RJ45)
Fixed I/O Ports	8 * GE (including 1 bypass pair)	8 * GE (including 1 bypass pair)	2 * SFP+ 8 * SFP 8 * GE	2 * SFP+ 8 * SFP 8 * GE
Available Slots for Expansion Modules	N/A	N/A	N/A	N/A
Expansion Module Option	N/A	N/A	N/A	N/A
Twin-mode HA	N/A	N/A	N/A	N/A
Local Storage	8 GB	8 GB	8 GB	8 GB
Expansion Storage Options	480GB / 960GB / 1.92TB SSD	480GB / 960GB / 1.92TB SSD	480GB / 960GB / 1.92TB SSD	480GB / 960GB / 1.92TB SSD
Power Specification	50W, Single AC (default), Dual AC (optional)	50W, Single AC (default), Dual AC (optional)	50W, Single AC (default), Dual AC (optional)	50W, Single AC (default), Dual AC (optional)
Power Supply	AC 100-240 V, 50/60 Hz	AC 100-240 V, 50/60 Hz	AC 100-240 V, 50/60 Hz	AC 100-240 V, 50/60 Hz
Form Factor	Rackmount, 1U	Rackmount, 1U	Rackmount, 1U	Rackmount, 1U
Weight	8.6 lb (3.9 kg)	8.6 lb (3.9 kg)	9 lb (4.1 kg)	9 lb (4.1 kg)
Temperature	32-104°F (0-40°C)	32-104°F (0-40°C)	0°C~40°C	0°C~40°C
Relative Humidity	10-95% non-condensing	10-95% non-condensing	10-95% non-condensing	10-95% non-condensing

A2000 / A2600 Front Panel



A2000
A2600

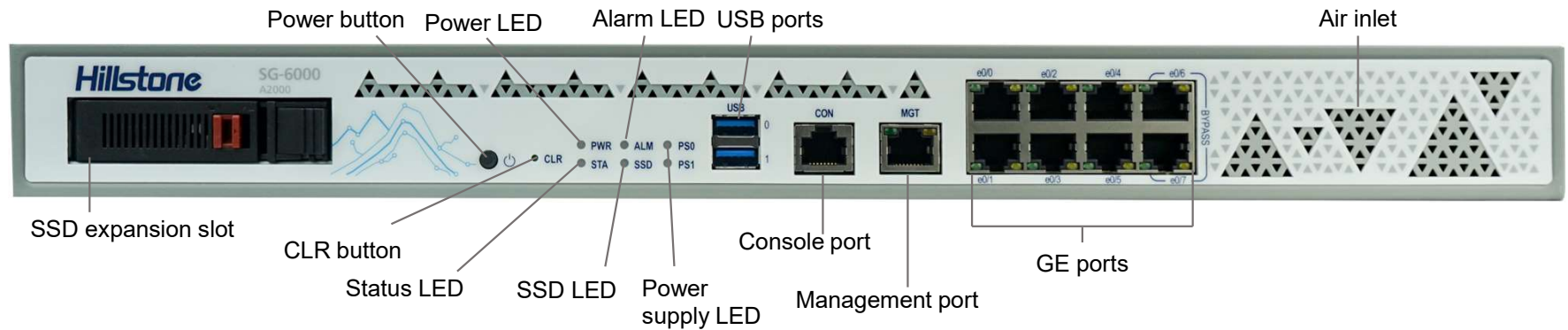

A2000 / A2600 Rear Panel



A2000
A2600



Grounding screw

Fan tray

Power socket

A2700 / A2800 Front Panel

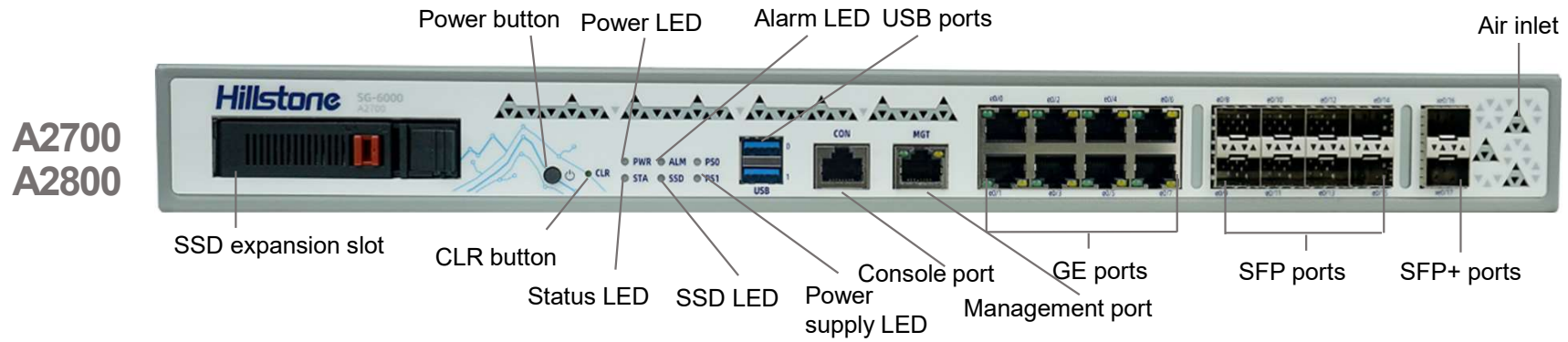

A2700 / A2800 Rear Panel



A2700
A2800



The Hillstone A-Series NGFW: Specifications



	Rackmount			
	SG-6000-A3000-IN	SG-6000-A3600-IN	SG-6000-A3700-IN	SG-6000-A3800-IN
Firewall Throughput	20 Gbps	20 Gbps	20/30 Gbps	20/40 Gbps
Maximum Concurrent Sessions	2 Million	3 Million	6 Million	8 Million
New Sessions/s	140,000	140,000	140,000	310,000
IPS Throughput	10 Gbps	10 Gbps	10 Gbps	20 Gbps
NGFW Throughput	5.5 Gbps	5.5 Gbps	6 Gbps	12 Gbps
Threat Protection Throughput	3 Gbps	3 Gbps	3.1 Gbps	6 Gbps
AV Throughput	4.9 Gbps	5.0 Gbps	5.2 Gbps	9.4 Gbps
IPsec VPN Throughput	6,000 Mbps	6,000 Mbps	6,500 Mbps	12,000 Mbps
SSL Proxy Throughput	950 Mbps	950 Mbps	950 Mbps	2 Gbps
Virtual Systems (Default/Max)	1/50	1/100	1/250	1/250
SSL VPN User Number	4,000	8,000	10,000	10,000
IPsec Tunnel Number	8,000	10,000	20,000	20,000
Management Ports	1 * Console Port, 2 * USB3.0 Ports, 1 * MGT Port (RJ45), 1 * HA Port (RJ45)	1 * Console Port, 2 * USB3.0 Ports, 1 * MGT Port (RJ45), 1 * HA Port (RJ45)	1 * Console Port, 2 * USB3.0 Ports, 1 * MGT Port (RJ45), 1 * HA Port (RJ45)	1 * Console Port, 2 * USB3.0 Ports, 1 * MGT Port (RJ45), 1 * HA Port (RJ45)
Fixed I/O Ports	2 * SFP+, 8 * SFP, 16 * GE (including 2 bypass pairs)	2 * SFP+, 8 * SFP, 16 * GE (including 2 bypass pairs)	2 * SFP+, 8 * SFP, 16 * GE (including 2 bypass pairs)	2 * SFP+, 8 * SFP, 16 * GE (including 2 bypass pairs)
Available Slots for Expansion Modules	N/A	N/A	1	1
Expansion Module Option	N/A	N/A	IOC-A-4SFP+-IN, IOC-A-2QSFP+-IN, IOC-A-2MM-BE-IN, IOC-A-2SM-BE-IN	IOC-A-4SFP+-IN, IOC-A-2QSFP+-IN, IOC-A-2MM-BE-IN, IOC-A-2SM-BE-IN
Twin-mode HA	Yes	Yes	Yes	Yes
Local Storage	8 GB	8 GB	8 GB	8 GB
Expansion Storage Options	480GB / 960GB / 1.92TB SSD	480GB / 960GB / 1.92TB SSD	480GB / 960GB / 1.92TB SSD	480GB / 960GB / 1.92TB SSD
Power Specification	100W, Single AC (default), Dual AC (optional)	100W, Single AC (default), Dual AC (optional)	100W, Single AC (default), Dual AC (optional)	100W, Dual AC (default), Dual DC (optional), hot swappable power
Power Supply	AC 100-240 V, 50/60 Hz	AC 100-240 V, 50/60 Hz	AC 100-240 V, 50/60 Hz	AC 100-240 V, 50/60 Hz
Form Factor	Rackmount, 1U	Rackmount, 1U	Rackmount, 1U	Rackmount, 1U
Weight	13.2 lb (6 kg)	13.2 lb (6 kg)	13.4 lb (6.1 kg)	15 lb (6.8 kg)
Temperature	32-104°F (0-40°C)	32-104°F (0-40°C)	32-104°F (0-40°C)	32-104°F (0-40°C)
Relative Humidity	10-95% non-condensing	10-95% non-condensing	10-95% non-condensing	10-95% non-condensing

A3000 / A3600 / A3700 / A3800 Front Panel

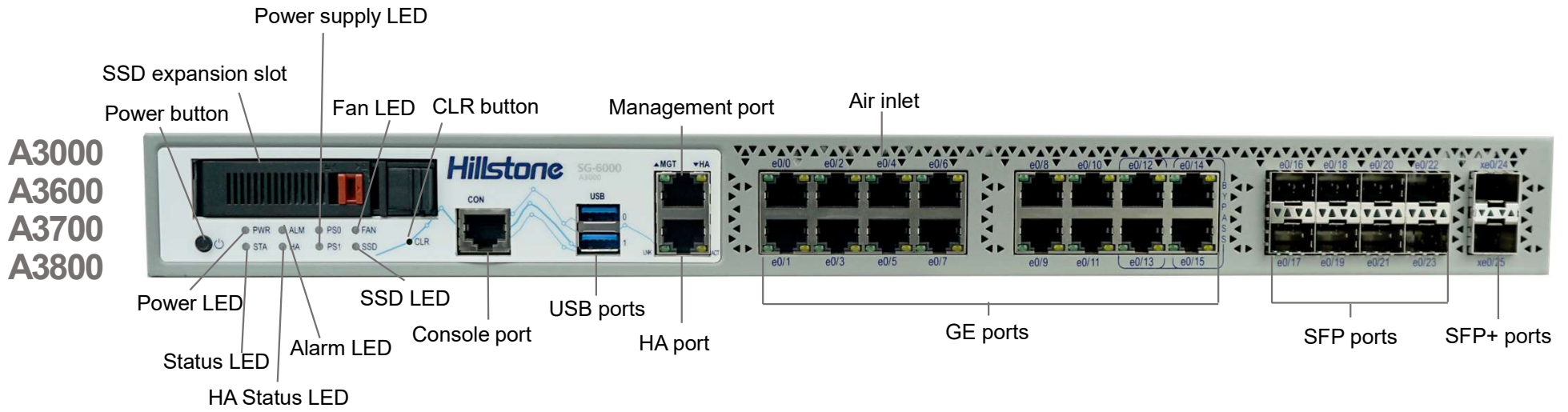

A3000 / A3600 / A3700 / A3800 Rear Panel



A3000
A3600



Grounding screw

Fan tray

Power socket

A3700



Grounding screw

General expansion slot

Fan tray

Power socket

A3800



Grounding screw

General expansion slot

Removable fan tray

Removable, hot swappable fan trays

Power socket

Removable, hot swappable power supply modules

The Hillstone A-Series NGFW: Specifications



	Rackmount							
	SG-6000-A5100-IN	SG-6000-A5155-IN	SG-6000-A5200-IN	SG-6000-A5255-IN	SG-6000-A5500-IN	SG-6000-A5555-IN	SG-6000-A5600-IN	SG-6000-A5800-IN
Firewall Throughput (without/with expansion module)	25/50 Gbps	25/50 Gbps	32/65 Gbps	32/65 Gbps	40/80 Gbps	40/80 Gbps	60/85 Gbps	80/95 Gbps
Maximum Concurrent Sessions	8 Million	8 Million	12 Million	12 Million	13 Million	13 Million	20 Million	25 Million
New Sessions/s	350,000	350,000	400,000	400,000	500,000	500,000	800,000	930,000
IPS Throughput	20/25 Gbps	20/30 Gbps	20/35 Gbps	20/35 Gbps	25/40 Gbps	25/37 Gbps	35/60 Gbps	45/75 Gbps
NGFW Throughput	20 Gbps	20 Gbps	20 Gbps	20 Gbps	25 Gbps	25 Gbps	29 Gbps	32 Gbps
Threat Protection Throughput	10 Gbps	10 Gbps	12 Gbps	12 Gbps	15 Gbps	15 Gbps	18 Gbps	20 Gbps
AV Throughput	12 Gbps	12 Gbps	12Gbps	12 Gbps	15Gbps	15 Gbps	20Gbps	25Gbps
IPsec VPN Throughput	15Gbps	15 Gbps	20Gbps	20 Gbps	28 Gbps	28 Gbps	36Gbps	45 Gbps
SSL Proxy Throughput	3 Gbps	3 Gbps	5 Gbps	5 Gbps	5 Gbps	5 Gbps	8.5 Gbps	8.5 Gbps
Virtual Systems (Default/Max)	1/250	1/250	1/250	1/250	1/250	1/250	1/500	1/500
SSL VPN User Number	10,000	10,000	10,000	10,000	10,000	10,000	10,000	10,000
IPsec Tunnel Number	20,000	20,000	20,000	20,000	20,000	20,000	20,000	20,000
Management Ports	1 * Console Port, 2 * USB3.0 Ports, 2 * HA Ports (SFP+), 1 * MGT Port (RJ45)	1 * Console Port, 2 * USB3.0 Ports, 1 * HA port (SFP), 1 * MGT Port (RJ45)	1 * Console Port, 2 * USB3.0 Ports, 2 * HA Ports (SFP+), 1 * MGT Port (RJ45)	1 * Console Port, 2 * USB3.0 Ports, 1 * HA port (SFP), 1 * MGT Port (RJ45)	1 * Console Port, 2 * USB3.0 Ports, 2 * HA Ports (SFP+), 1 * MGT Port (RJ45)	1 * Console Port, 2 * USB3.0 Ports, 1 * HA port (SFP), 1 * MGT Port (RJ45)	1 * Console Port, 2 * USB3.0 Ports, 1 * HA Port (SFP), 1 * MGT Port (RJ45)	1 * Console Port, 2 * USB3.0 Ports, 1 * HA Port (SFP), 1 * MGT Port (RJ45)
Fixed I/O Ports	6 * SFP+, 16 * SFP, 8 * GE (including 2 bypass pairs)	2 * QSFP+, 16 * SFP+, 8 * GE (including 4 bypass pairs)	6 * SFP+, 16 * SFP, 8 * GE (including 2 bypass pairs)	2 * QSFP+, 16 * SFP+, 8 * GE (including 4 bypass pairs)	6 * SFP+, 16 * SFP, 8 * GE (including 2 bypass pairs)	2 * QSFP+, 16 * SFP+, 8 * GE (including 4 bypass pairs)	2 * QSFP+, 16 * SFP+, 8 * GE (including 4 bypass pairs)	2 * QSFP+, 16 * SFP+, 8 * GE (including 4 bypass pairs)
Available Slots for Expansion Modules	1	1	1	1	1	1	1	1
Expansion Module Option	IOC-A-4SFP+-IN, IOC-A-2QSFP+-IN, IOC-A-2MM-BE-IN, IOC-A-2SM-BE-IN	IOC-A-4SFP+-IN, IOC-A-2QSFP+-IN, IOC-A-2MM-BE-IN, IOC-A-2SM-BE-IN	IOC-A-4SFP+-IN, IOC-A-2QSFP+-IN, IOC-A-2MM-BE-IN, IOC-A-2SM-BE-IN	IOC-A-4SFP+-IN, IOC-A-2QSFP+-IN, IOC-A-2MM-BE-IN, IOC-A-2SM-BE-IN	IOC-A-4SFP+-IN, IOC-A-2QSFP+-IN, IOC-A-2MM-BE-IN, IOC-A-2SM-BE-IN	IOC-A-4SFP+-IN, IOC-A-2QSFP+-IN, IOC-A-2MM-BE-IN, IOC-A-2SM-BE-IN	IOC-A-4SFP+-IN, IOC-A-2QSFP+-IN, IOC-A-2MM-BE-IN, IOC-A-2SM-BE-IN	IOC-A-4SFP+-IN, IOC-A-2QSFP+-IN, IOC-A-2MM-BE-IN, IOC-A-2SM-BE-IN
Twin-mode HA	Yes	Yes	Yes	Yes	Yes	Yes	Yes	Yes
Local Storage	64 GB	64 GB	64 GB	64 GB	64 GB	64 GB	64 GB	64 GB
Expansion Storage Options	480GB / 960GB / 1.92TB SSD	480GB / 960GB / 1.92TB SSD	480GB / 960GB / 1.92TB SSD	480GB / 960GB / 1.92TB SSD	480GB / 960GB / 1.92TB SSD	480GB / 960GB / 1.92TB SSD	480GB / 960GB / 1.92TB SSD	480GB / 960GB / 1.92TB SSD
Power Specification	280W, Dual AC (default), Dual DC (optional)	300W, Dual AC (default), Dual DC (optional)	280W, Dual AC (default), Dual DC (optional)	300W, Dual AC (default), Dual DC (optional)	280W, Dual AC (default), Dual DC (optional)	300W, Dual AC (default), Dual DC (optional)	300W, Dual AC (default), Dual DC (optional)	300W, Dual AC (default), Dual DC (optional)
Power Supply	AC 100-240 V, 50/60 Hz DC -36~-72 V	AC 100-240 V, 50/60 Hz DC -36~-72 V	AC 100-240 V, 50/60 Hz DC -36~-72 V	AC 100-240 V, 50/60 Hz DC -36~-72 V	AC 100-240 V, 50/60 Hz DC -36~-72 V	AC 100-240 V, 50/60 Hz DC -36~-72 V	AC 100-240 V, 50/60 Hz DC -36~-72 V	AC 100-240 V, 50/60 Hz DC -36~-72 V
Form Factor	Rackmount, 1U	Rackmount, 1U	Rackmount, 1U	Rackmount, 1U	Rackmount, 1U	Rackmount, 1U	Rackmount, 1U	Rackmount, 1U
Weight	18.7 lb (8.5 kg)	18.7 lb (8.5 kg)	18.7 lb (8.5 kg)	18.7 lb (8.5 kg)	18.7 lb (8.5 kg)	18.7 lb (8.5 kg)	18.7 lb (8.5 kg)	18.7 lb (8.5 kg)
Temperature	32-104°F (0-40°C)	32-104°F (0-40°C)	32-104°F (0-40°C)	32-104°F (0-40°C)	32-104°F (0-40°C)	32-104°F (0-40°C)	32-104°F (0-40°C)	32-104°F (0-40°C)
Relative Humidity	10-95% non-condensing	10-95% non-condensing	10-95% non-condensing	10-95% non-condensing	10-95% non-condensing	10-95% non-condensing	10-95% non-condensing	10-95% non-condensing

A5100 / A5200 / A5500 Front Panel

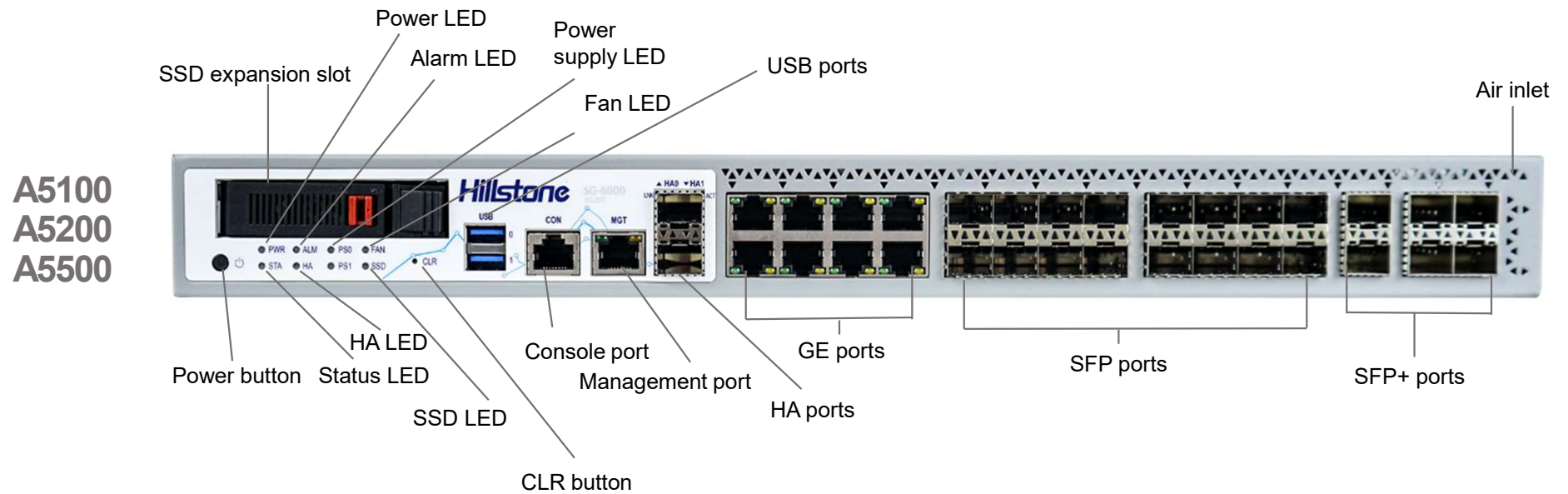

A5100 / A5200 / A5500 Rear Panel



A5100
A5200
A5500



Grounding screw
General expansion slot

Removable fan tray

Removable, hot swappable fan trays

Power socket

Removable, hot swappable power supply modules

A5155 / A5255 / A5555 / A5600 / A5800 Front Panel



A5155
A5255
A5555
A5600
A5800

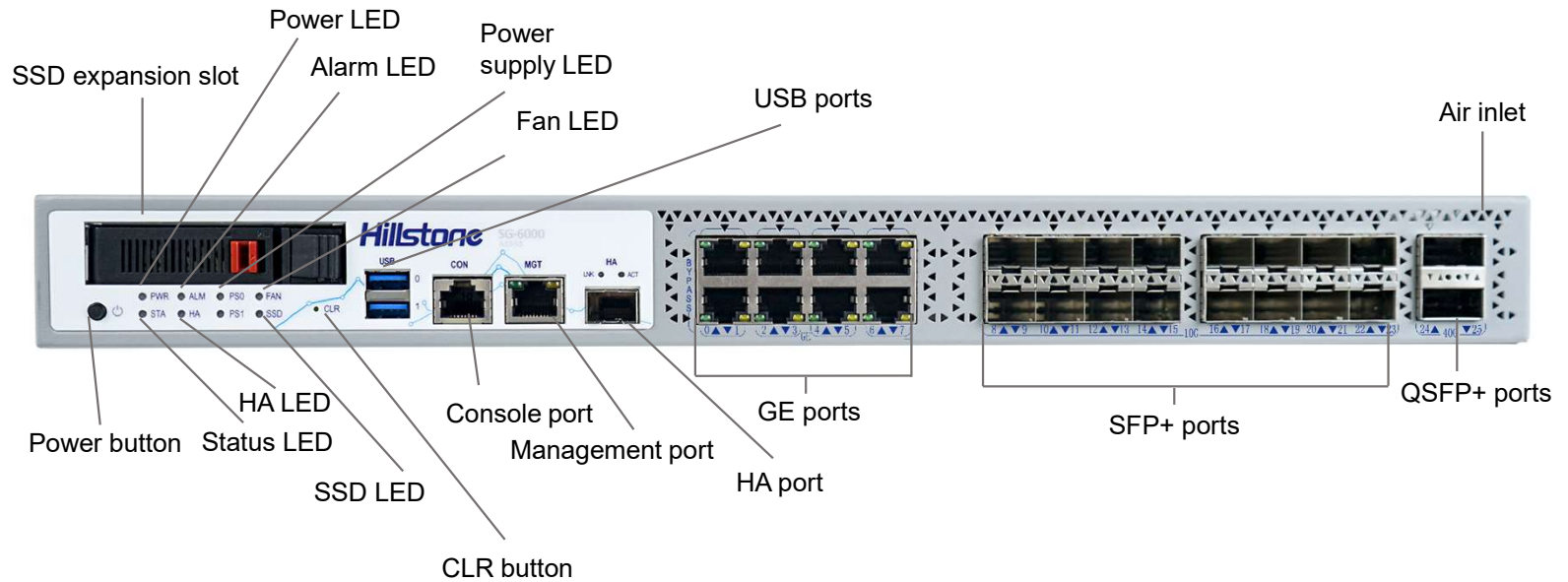

A5155 / A5255 / A5555 / A5600 / A5800 Rear Panel



A5155
A5255
A5555
A5600
A5800



Grounding screw

General expansion slot

Removable fan tray

Removable, hot swappable fan trays

Power socket

Removable, hot swappable power supply modules

The Hillstone A-Series NGFW: Specifications



	Rackmount	
	SG-6000-A6800-IN	SG-6000-A7600-IN
Firewall Throughput (without/with expansion module)	200 Gbps	280/320 Gbps
Maximum Concurrent Sessions	30 Million	42 Million
New Sessions/s	900,000	900,000
IPS Throughput	70 Gbps	70 Gbps
NGFW Throughput	40 Gbps	45 Gbps
Threat Protection Throughput	22 Gbps	24 Gbps
AV Throughput	25 Gbps	25 Gbps
IPsec VPN Throughput	45 Gbps	45 Gbps
SSL Proxy Throughput	8.5 Gbps	8.5 Gbps
Virtual Systems (Default/Max)	1/500	1/500
SSL VPN User Number	10,000	10,000
IPsec Tunnel Number	20,000	20,000
Management Ports	1 * Console Port, 2 * USB3.0 Ports, 1 * MGT Port (RJ45), 1 * HA port (SFP)	1 * Console Port, 2 * USB3.0 Ports, 1 * MGT Port (RJ45), 1 * HA port (SFP)
Fixed I/O Ports	4 * QSFP28 (or 2 * QSFP+, 2 * QSFP28) 12 * SFP+ 8 * SFP+/SFP	4 * QSFP28 (or 2 * QSFP+, 2 * QSFP28) 12 * SFP+ 8 * SFP+/SFP
Available Slots for Expansion Modules	1	1
Expansion Module Option	IOC-A-4SFP+-IN, IOC-A-2QSFP+-IN, IOC-A-2MM-BE-IN, IOC-A-2SM-BE-IN	IOC-A-4SFP+-IN, IOC-A-2QSFP+-IN, IOC-A-2MM-BE-IN, IOC-A-2SM-BE-IN
Twin-mode HA	Yes	Yes
Local Storage	64 GB	64 GB
Expansion Storage Options	480GB / 960GB / 1.92TB SSD	480GB / 960GB / 1.92TB SSD
Power Specification	310W, Dual AC (default), Dual DC (optional)	310W, Dual AC (default), Dual DC (optional)
Power Supply	AC 100-240 V, 50/60 Hz DC -36~-72 V	AC 100-240 V, 50/60 Hz DC -36~-72 V
Form Factor	Rackmount, 1U	Rackmount, 1U
Weight	20.3 lb (9.2 kg)	20.3 lb (9.2 kg)
Temperature	32-104°F (0-40°C)	32-104°F (0-40°C)
Relative Humidity	10-95% non-condensing	10-95% non-condensing

A6800 / A7600 Front Panel



A6800
A7600

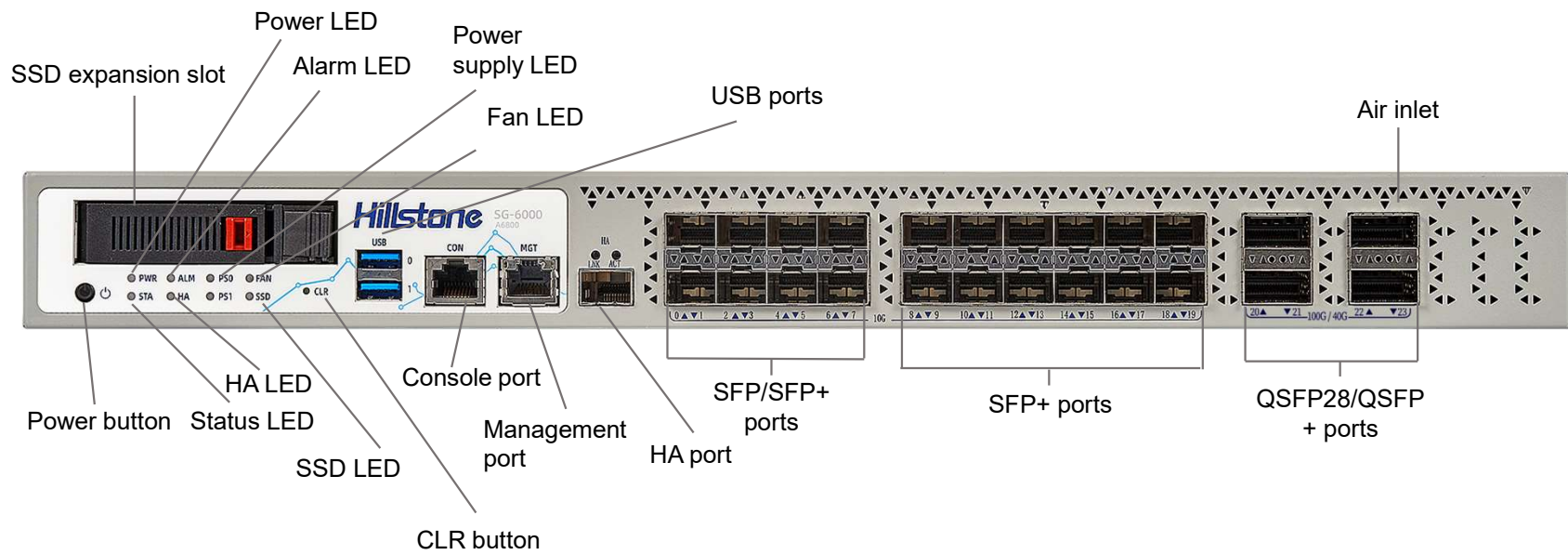

A6800 / A7600 Rear Panel



A6800
A7600

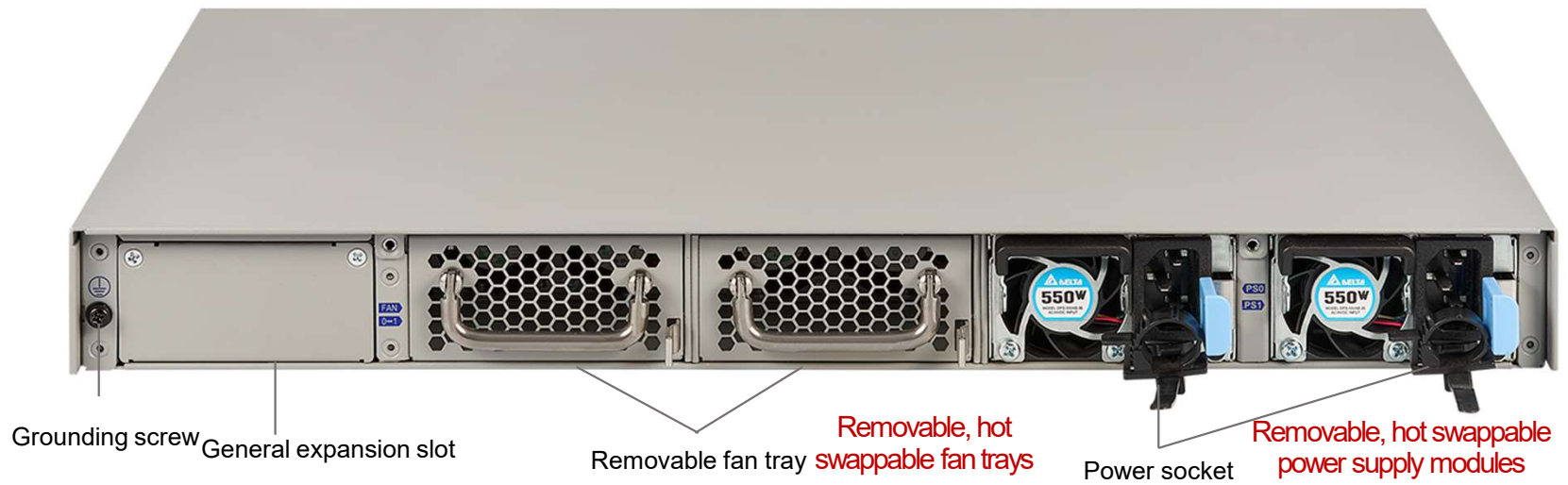

Expansion Modules

- A3700, A3800, A5100, A5155, A5200, A5255, A5500, A5555, A5600, A5800, A6800 and A7600 provide expansion slots for expansion modules.
- There are a total of 4 expansion modules available.

IOC-A-4SFP+-IN

IOC-A-2MM-BE-IN

IOC-A-2SM-BE-IN

IOC-A-2QSFP+-IN

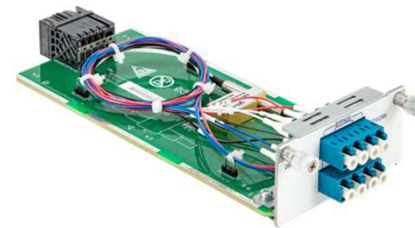
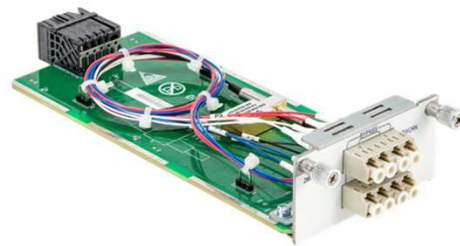
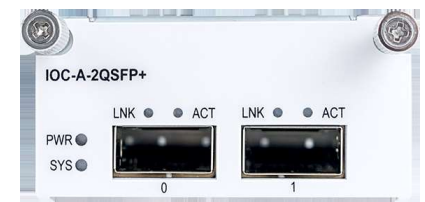
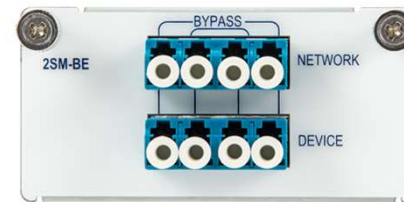
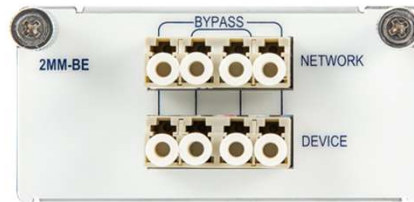
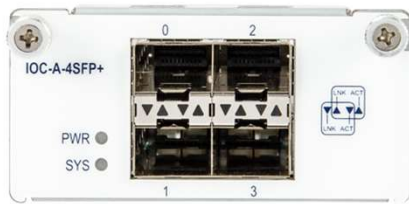

**4 SFP+ expansion module
(adaptive to SFP module)**

**Multi-mode bypass expansion
module**

**Single-mode bypass
expansion module**

2QSFP+ expansion module

Expansion SSD: Images



256 GB SSD
For A1000, A1100



480 GB / 960 GB / 1.92 TB SSD
For A2000, A2600, A2700, A2800, A3000, A3600, A3700, A3800, A5100, A5155, A5200, A5255, A5500, A5555, A5600, A5800, A6800, A7600

Notes



- Management

- The A-Series devices can be managed via console, telnet, ssh, http, and https channels.
- The default management port of A1000 is eth0/0 port, while all other models have MGT port as the management port.
- Ssh and https are available by default.

- Hot Swap

- The expansion module is not hot-swappable.
- All optical modules are hot-swappable.
- A3800 supports removable fan trays, and the fan trays are hot-swappable.
- A3800, A5x00, A5x55, A6800 and A7600 support removable power modules, and the power modules are hot-swappable. The power modules of A3800, A6800 and A7600 are the same, which are not interchangeable with the power modules of A5x00-IN and A5x55.



Integrative
Cyber
Security

Hillstone
NETWORKS

+1 408 508 6750
inquiry@hillstonenet.com
5201 Great America Pkwy, #420
Santa Clara, CA 95054
www.hillstonenet.com

