

HP A5820X & A5800 Switch Series

MAD Overview and Configuration Examples

Part number: 5998-1612

Software version: Release 1211

Document version: 5W100-20110430



Legal and notice information

© Copyright 2011 Hewlett-Packard Development Company, L.P.

No part of this documentation may be reproduced or transmitted in any form or by any means without prior written consent of Hewlett-Packard Development Company, L.P.

The information contained herein is subject to change without notice.

HEWLETT-PACKARD COMPANY MAKES NO WARRANTY OF ANY KIND WITH REGARD TO THIS MATERIAL, INCLUDING, BUT NOT LIMITED TO, THE IMPLIED WARRANTIES OF MERCHANTABILITY AND FITNESS FOR A PARTICULAR PURPOSE. Hewlett-Packard shall not be liable for errors contained herein or for incidental or consequential damages in connection with the furnishing, performance, or use of this material.

The only warranties for HP products and services are set forth in the express warranty statements accompanying such products and services. Nothing herein should be construed as constituting an additional warranty. HP shall not be liable for technical or editorial errors or omissions contained herein.

Contacting HP

For worldwide technical support information, see the HP support website:

<http://www.hp.com/support>

Before contacting HP, collect the following information:

- Product model names and numbers
- Technical support registration number (if applicable)
- Product serial numbers
- Error messages
- Operating system type and revision level
- Detailed questions

Subscription service

HP recommends that you register your product at the Subscriber's Choice for Business website:

<http://www.hp.com/go/e-updates>

After registering, you will receive e-mail notification of product enhancements, new driver versions, firmware updates, and other product resources.

Warranty

The Hewlett-Packard Limited Warranty Statement for this product and the HP Software License Terms which apply to any software accompanying this product are available on the HP networking Web site at www.hp.com/networking/warranty. The customer warranty support and services information are available on the HP networking Web site at www.hp.com/networking/support. Additionally, your HP-authorized network reseller can provide you with assistance, both with services that they offer and with services offered by HP.

Documentation

For the latest documentation, visit the HP website, www.hp.com, and select the **Support & Troubleshooting** link.

- Choose **See support and troubleshooting information** radio button
- Enter product name/number OR choose the automatic product name/number detection OR select a product category
- From the product page, choose **Manuals** link to see the documentation associated with your product.

Contents

MAD Overview and Configuration Examples	1
Prerequisites	1
Overview	1
MAD Approaches	2
LACP MAD	2
BFD MAD	3
ARP MAD	4
A Comparison of the MAD Approaches	5
Application Scenarios	5
LACP MAD Application Scenario	5
BFD MAD Application Scenario	6
ARP MAD Application Scenario	6
MAD Configuration Examples	6
LACP MAD Configuration Example	7
BFD MAD Configuration Examples	10
ARP MAD Configuration Examples	14
Hybrid MAD Configuration Example	18

MAD Overview and Configuration Examples

Prerequisites

This document is applicable to the HP A5820X and A5800 Switch Series, Release 1211.

This document assumes that you are familiar with Intelligent Resilient Framework (IRF) technology.

Overview

The multi-active detection (MAD) feature detects identical active IRF virtual devices and handles multi-active collisions on a network.

See [Figure 1](#). An IRF virtual device appears as a single node on the network. All its member switches share the same IP address and Layer 3 configurations such as the routing configurations. When an IRF link failure causes the IRF virtual device to split, multiple active IRF virtual devices that have the same IP address and Layer 3 configurations appear on the network. They cause routing problems and data loss.

Figure 1 Network problems caused by IRF virtual device partition

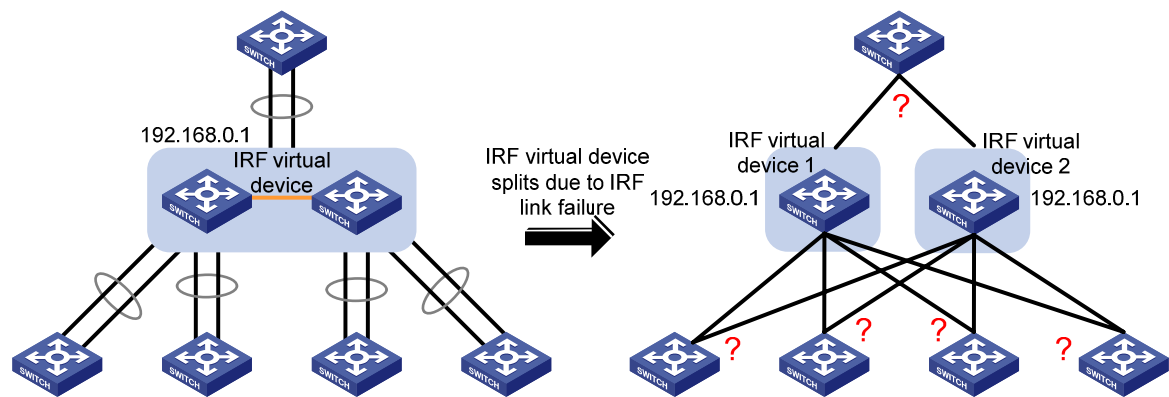

To detect and handle multi-active collisions, the MAD feature identifies each IRF virtual device with an active ID, which is the member ID of the master switch. If multiple identical active IRF virtual devices are detected, only the one that has the lowest active ID can operate in the active state and forward traffic. MAD sets all other IRF virtual devices in the recovery state, and shuts down all their physical ports but the console and IRF ports, as shown in [Figure 2](#).

Figure 2 Collision handling

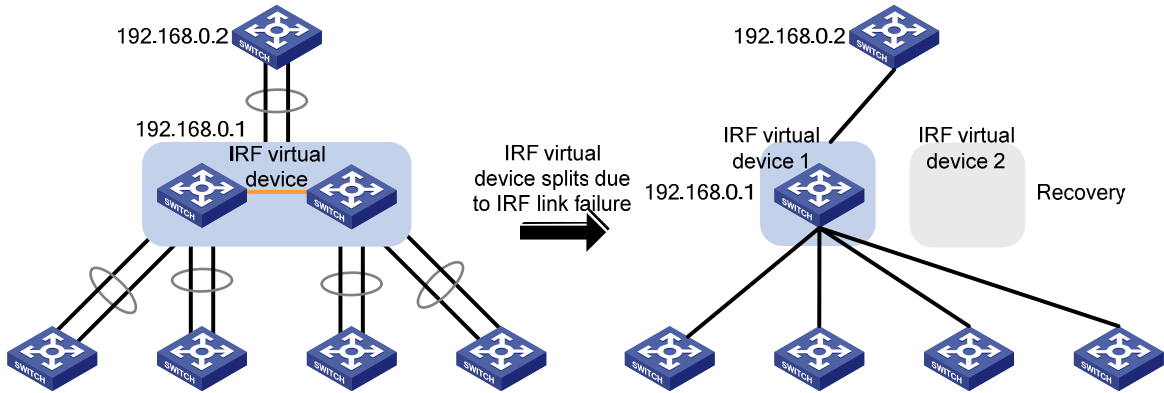

MAD eliminates the impact of IRF virtual device partition on networks. After you repair the failed IRF link, the IRF virtual device in the recovery state merges into the IRF virtual device in the active state and restores its previous IRF state, as shown in Figure 3.

Figure 3 Failure recovery

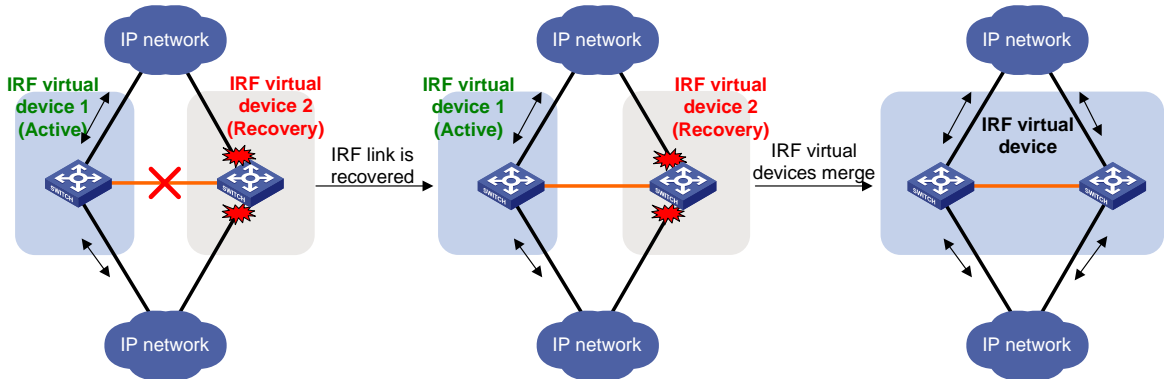

MAD Approaches

Three MAD approaches are available for different network scenarios:

- LACP MAD
- BFD MAD
- ARP MAD

LACP MAD

LACP MAD is implemented by extending the Link Aggregation Control Protocol (LACP). It requires that every IRF member switch have a link with an intermediate switch, and all these links form a dynamic link aggregation group, as shown in Figure 4.

The member switches send extended LACP data units (LACPDUs) with a type length value (TLV) that conveys the active ID of the IRF virtual device. The intermediate switch transparently forwards the extended LACPDUs received from a member switch to all other member switches:

- If the IRF virtual device is operating normally, the active IDs in the extended LACPDUs sent by all member switches are the same.

- If the IRF virtual device has split, the active IDs in the extended LACPDU sent by the member switches in different IRF virtual devices are different. Then, LACP MAD sets the IRF virtual device with higher active ID in the recovery state, and shuts down all its physical ports but the IRF ports. The IRF virtual device with lower active ID is still in the active state and forwards traffic.

Figure 4 LACP MAD mechanism

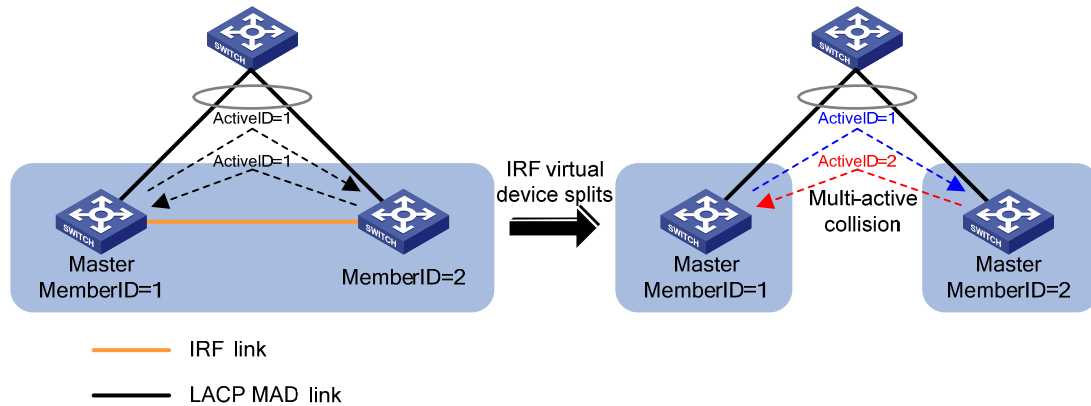

BFD MAD

BFD MAD is implemented by using the Bidirectional Forwarding Detection (BFD) protocol, which helps fast detect link failures and loss of IP connectivity.

To use BFD MAD:

- Set up dedicated BFD MAD links between each pair of IRF member switches or set up a dedicated BFD MAD link between each IRF member switch and an intermediate switch. Do not use the BFD MAD links for data transmission.
- Assign all ports of the BFD MAD links to a dedicated VLAN, create a VLAN interface for the VLAN, and assign a MAD IP address for each member switch. The MAD IP addresses are used for setting up BFD sessions between member switches, and they must be in the same network segment.

As shown in [Figure 5](#), with BFD MAD, the master switch tries to establish BFD sessions with other member switches by using its MAD IP address as the source IP address:

- If the IRF virtual device is operating normally, only the MAD IP address of the master switch is effective, and the BFD sessions cannot be established.
- When the IRF virtual device splits, the IP addresses of the master switches in the partitioned IRF virtual devices take effect, and the two switches establishes a BFD session. The IRF virtual devices exchange their active IDs through the BFD session, and make a comparison. The virtual device with higher active ID changes to the recovery state and shuts down all physical ports but the IRF ports. The IRF virtual device with lower active ID remains in the active state and forwards traffic.

Figure 5 BFD MAD mechanism

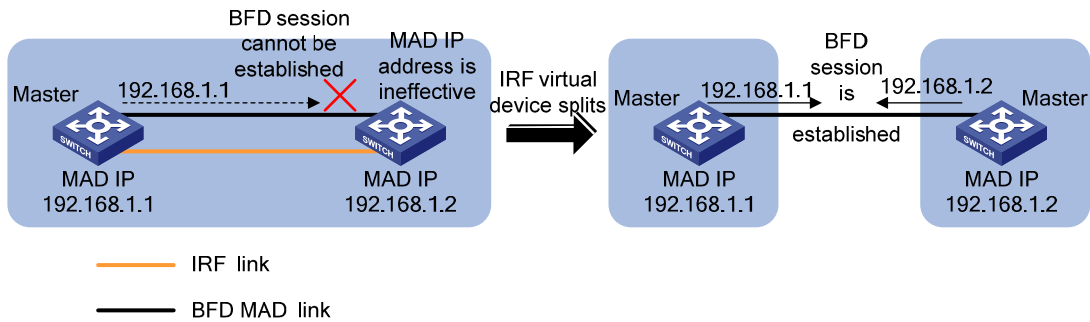

ARP MAD

ARP MAD detects multi-active collisions by sending extended gratuitous ARP packets that convey the active IDs of IRF virtual devices.

You can set up ARP MAD links between neighbor IRF member switches, or more commonly, between each IRF member switch and an intermediate switch. In the latter case, you must also enable MSTP on the IRF virtual device and the intermediate switch. As shown in [Figure 6](#):

- If the IRF virtual device is operating normally, MSTP blocks the redundant link between the intermediate switch and the IRF virtual device. The gratuitous ARP packets sent by one member switch cannot reach the other.
- When the IRF virtual device splits, MSTP unblocks the redundant link, and the two IRF virtual devices can receive gratuitous ARP packets from each other. These gratuitous packets carry the same IP address but different MAC addresses, resulting in collisions. Then, the separated IRF virtual devices compare their active IDs. The virtual device with higher active ID changes to the recovery state and shuts down all physical ports but the IRF ports. The IRF virtual device with lower active ID remains in the active state and forwards traffic.

Figure 6 ARP MAD mechanism

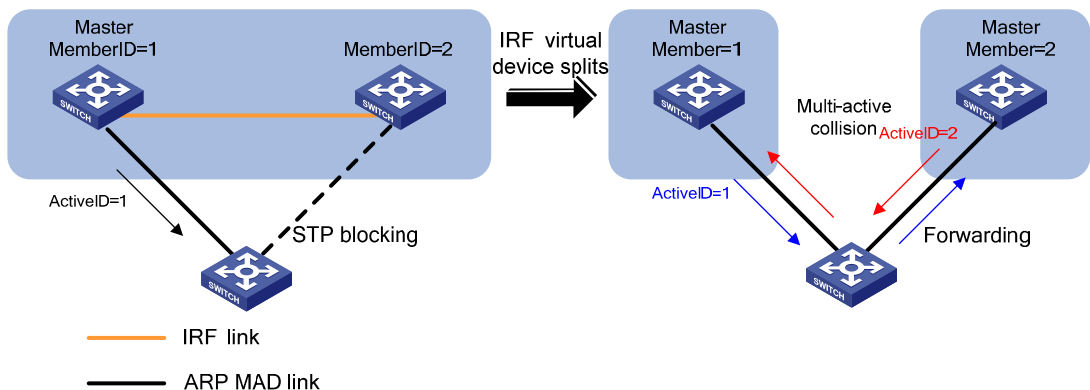

NOTE:

Configure the IRF virtual device to update its bridge MAC address as soon as the master switch leaves, so ARP MAD can promptly detect IRF partition events. For more information about the configuration, see *IRF* in the *IRF Configuration Guide*.

A Comparison of the MAD Approaches

MAD approach	Advantages	Disadvantages
LACP MAD	<ul style="list-style-type: none"> The detection speed is very fast. Suitable for link aggregation scenarios Requires no dedicated physical ports or interfaces. 	Requires an intermediate switch, which must be an HP switch that supports the extended LACP.
BFD MAD	<ul style="list-style-type: none"> The detection speed is fast. Suitable for various network scenarios. No special requirements for intermediate devices. 	Requires dedicated physical ports and Layer 3 interfaces, which cannot be used to transmit service traffic.
ARP MAD	<ul style="list-style-type: none"> No special requirements for intermediate devices. Requires no dedicated physical ports if the detection is performed through an intermediate switch 	<ul style="list-style-type: none"> The detection speed is slower than the other two approaches. Requires dedicated Layer 3 interfaces.

Application Scenarios

This section describes the application scenarios of the three MAD approaches based on the typical IRF virtual device topology in Figure 7.

Figure 7 A typical IRF virtual device topology

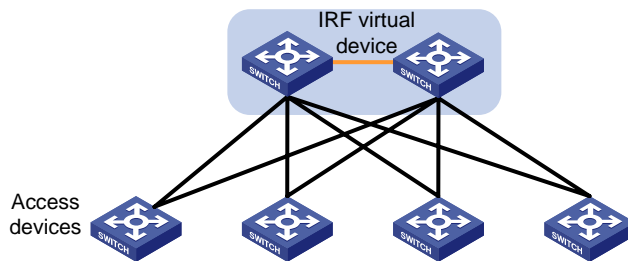

LACP MAD Application Scenario

The access switches are HP switches that support extended LACP. Each of them connects to the two IRF member switches through link aggregation, as shown in Figure 8.

Figure 8 Typical LACP MAD application scenario

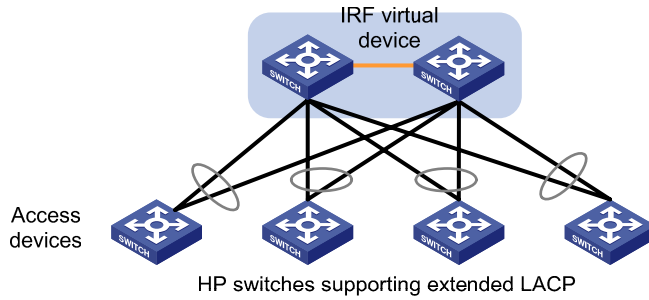

BFD MAD Application Scenario

The access switches are non-HP or HP switches that do not support extended LACP. Each of them connects to the two IRF member switches through link aggregation, as shown in Figure 9.

Figure 9 Typical BFD MAD application scenario

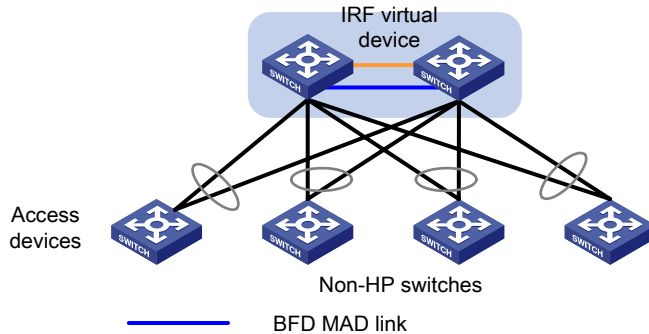

ARP MAD Application Scenario

Each access switch is dual homed to the IRF virtual device, and both the access switches and the IRF virtual device run MSTP, as shown in Figure 10.

Figure 10 Typical ARP MAD scenario

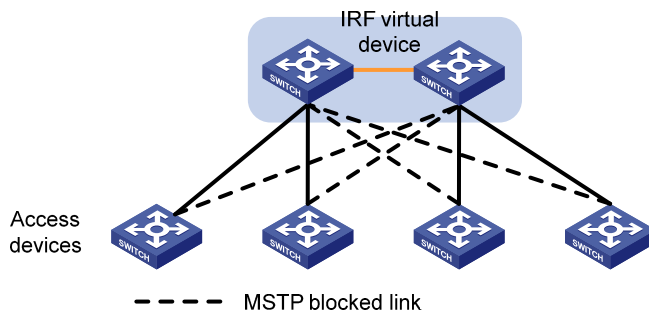

MAD Configuration Examples

Create an IRF virtual device by connecting four HP A5800 switches in the daisy chain (Figure 11) or ring (Figure 12) topology.

Figure 11 An IRF virtual device in the daisy chain topology

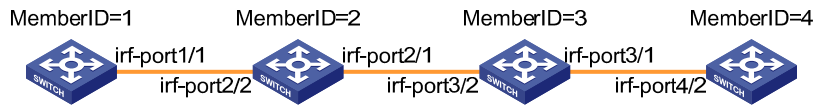
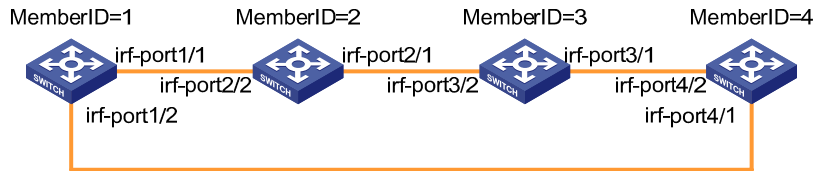

Figure 12 An IRF virtual device in the ring topology



This section shows how to configure different MAD approaches in these two topologies:

Table 1 MAD configuration examples

MAD approach	Configuration example
LACP MAD	LACP MAD Configuration Example
BFD MAD	Performing BFD MAD without any intermediate switch
	Performing BFD MAD through an intermediate switch
	Performing ARP MAD through an intermediate switch
ARP MAD	Performing ARP MAD without any intermediate switch (daisy chain topology)
	Performing ARP MAD without any intermediate switch (ring topology)
Hybrid MAD Configuration Example	

NOTE:

All configuration examples in this section cover only the MAD configuration procedures. For how to set up an IRF virtual device, see the configuration guide for your switch.

LACP MAD Configuration Example

Setting up aggregate links

LACP MAD detects IRF virtual device partition events by sending extended LACPDUs on aggregate links. The IRF virtual device can use either the ring or daisy chain topology, but each member switch must set up one LACP-enabled link with an intermediate switch, as shown in [Figure 13](#).

Figure 13 Connect IRF member switches to an intermediate switch with LACP-enabled links

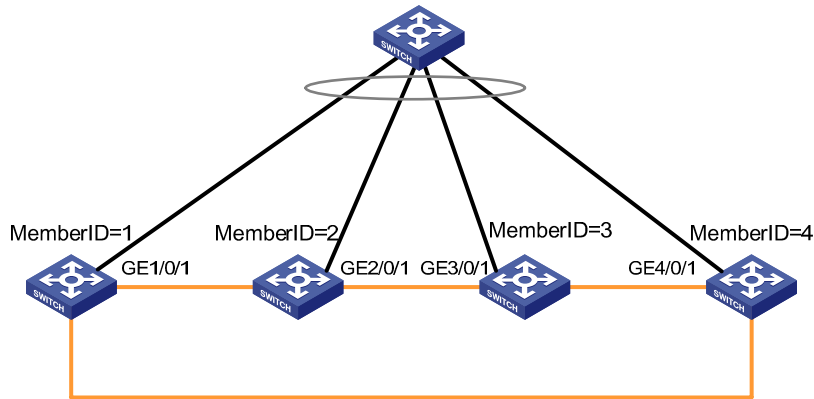

Configuration procedure

1. Configure the IRF virtual device

Create a dynamic aggregate interface and enable LACP MAD.

```
<Sysname> system-view
[Sysname] interface bridge-aggregation 2
[Sysname-Bridge-Aggregation2] link-aggregation mode dynamic
[Sysname-Bridge-Aggregation2] mad enable
[Sysname-Bridge-Aggregation2] quit
```

Assign ports GigabitEthernet 1/0/1, GigabitEthernet 2/0/1, GigabitEthernet 3/0/1, and GigabitEthernet 4/0/1 to the aggregate interface.

```
[Sysname] interface gigabitethernet 1/0/1
[Sysname-GigabitEthernet1/0/1] port link-aggregation group 2
[Sysname-GigabitEthernet1/0/1] quit
[Sysname] interface gigabitethernet 2/0/1
[Sysname-GigabitEthernet2/0/1] port link-aggregation group 2
[Sysname-GigabitEthernet2/0/1] quit
[Sysname] interface gigabitethernet 3/0/1
[Sysname-GigabitEthernet3/0/1] port link-aggregation group 2
[Sysname-GigabitEthernet3/0/1] quit
[Sysname] interface gigabitethernet 4/0/1
[Sysname-GigabitEthernet4/0/1] port link-aggregation group 2
[Sysname-GigabitEthernet4/0/1] quit
```

2. Configure the intermediate switch

Create a dynamic aggregate interface, and assign the ports (GigabitEthernet 1/0/1 to GigabitEthernet 1/0/4) connected to the IRF member switches to the aggregate interface.

```
<Device> system-view
[Device] interface bridge-aggregation 2
[Device-Bridge-Aggregation2] link-aggregation mode dynamic
[Device-Bridge-Aggregation2] quit
[Device] interface gigabitethernet 1/0/1
[Device-GigabitEthernet1/0/1] port link-aggregation group 2
[Device-GigabitEthernet1/0/1] quit
[Device] interface gigabitethernet 1/0/2
```

```

[Device-GigabitEthernet1/0/2] port link-aggregation group 2
[Device-GigabitEthernet1/0/2] quit
[Device] interface gigabitethernet 1/0/3
[Device-GigabitEthernet1/0/3] port link-aggregation group 2
[Device-GigabitEthernet1/0/3] quit
[Device] interface gigabitethernet 1/0/4
[Device-GigabitEthernet1/0/4] port link-aggregation group 2
[Device-GigabitEthernet1/0/4] quit

```

NOTE:

If the intermediate switch is in another IRF virtual device, you must assign different IRF domain IDs for the two virtual devices to avoid false detection of IRF partition. For more information, see [Performing LACP MAD Between IRF Virtual Devices](#).

Multi-active detection and collision handling

When the IRF link between member switches 1 and 4 fails, the IRF virtual device changes to a daisy chain topology, and no IRF partition occurs. If the IRF link between member switches 2 and 3 also fails, the IRF virtual device splits in two.

Member switches 2 and 3 are now the respective masters in the two IRF virtual devices. LACP MAD compares their active IDs, and sets the IRF virtual device that contains switch 2, which has a lower active ID, in the active state, and sets the other IRF virtual device in the recovery state.

Figure 14 Multi-active detection and collision handling with LACP MAD

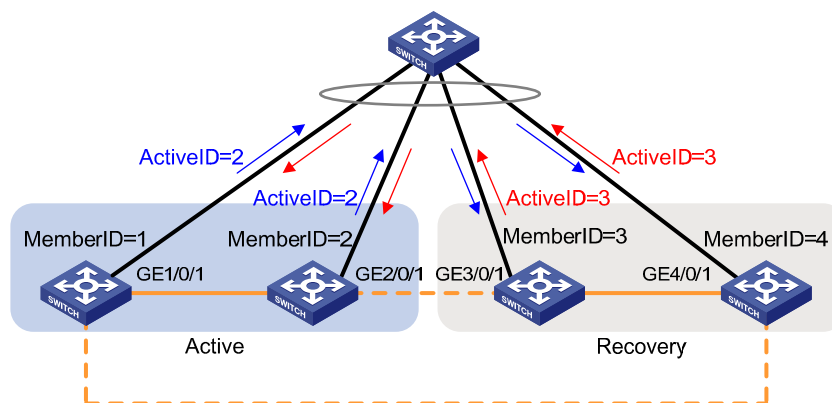

Performing LACP MAD Between IRF Virtual Devices

With LACP MAD, you can configure two IRF virtual devices as the intermediate switch for each other the same as you configure a standalone switch. To avoid false detection of IRF partition, which can cause one IRF virtual device to enter the recovery state, you must assign different IRF domain IDs for the two virtual devices. The IRF domain ID is included in the extended LACPDUs for IRF virtual device identification.

NOTE:

HP recommends you connect each switch in one IRF virtual device to all the switches in the other IRF virtual device, as shown in [Figure 15](#). The full mesh of connections ensure that the switches in one IRF virtual device can always receive LACP packets without being affected by any IRF link failure in the other IRF virtual device.

Figure 15 LACP MAD between IRF virtual devices

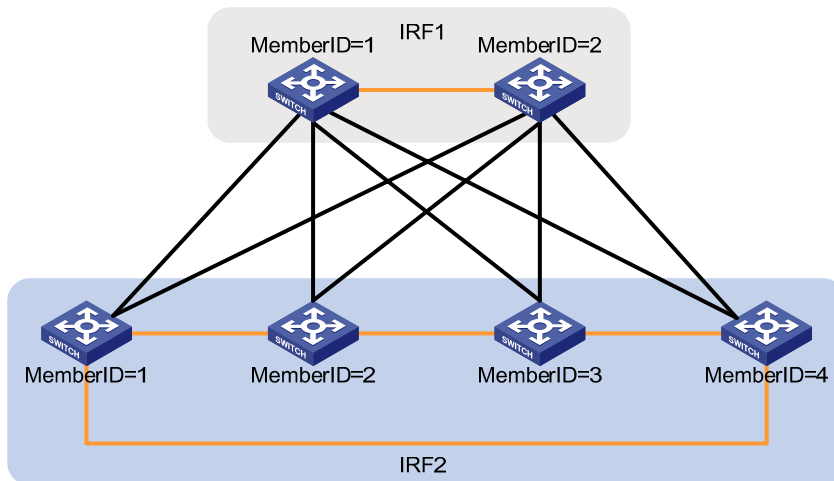

1. Configure IRF 1

Set the IRF domain ID to 1.

```
<Sysname> system-view
[Sysname] irf domain 1
```

Create the dynamic aggregate interface Bridge-aggregation 1 and enable LACP MAD on the interface.

```
<Sysname> system-view
[Sysname] interface bridge-aggregation 1
[Sysname-Bridge-Aggregation1] link-aggregation mode dynamic
[Sysname-Bridge-Aggregation1] mad enable
[Sysname-Bridge-Aggregation1] quit
```

Assign the ports connected to IRF 2 to the interface Bridge-aggregation 1.

Omitted

2. Configure IRF 2

Set the IRF domain ID to 2.

```
<Sysname> system-view
[Sysname] irf domain 2
```

Create the dynamic aggregate interface Bridge-aggregation 1 and enable LACP MAD on the interface.

```
<Sysname> system-view
[Sysname] interface bridge-aggregation 1
[Sysname-Bridge-Aggregation1] link-aggregation mode dynamic
[Sysname-Bridge-Aggregation1] mad enable
[Sysname-Bridge-Aggregation1] quit
```

Assign the ports connected to IRF 1 to the interface Bridge-aggregation 1.

Omitted

BFD MAD Configuration Examples

You can perform BFD MAD by:

- Connecting all IRF member switches with dedicated BFD MAD links in the full mesh topology, as shown in Figure 16. With BFD MAD, only the master switch attempts to set up BFD sessions with other member switches, which cannot transparently forward BFD packets. If the IRF virtual device splits, the full mesh topology ensures that the masters in any two separated IRF virtual devices have a directly connected BFD MAD link.
- Setting up a dedicated BFD MAD link with an intermediate switch for each IRF member switch.

NOTE:

Whichever connection approach is used, there is no risk of broadcast storms, because BFD MAD links do not transmit service data, and IRF member switches cannot transparently forward BFD packets.

Performing BFD MAD without any intermediate switch

The BFD MAD configuration procedure is the same for the daisy chain and ring topologies. This example uses the ring topology.

1. Set up BFD MAD links

Set up BFD MAD links between every two switches, as shown in Figure 16.

Figure 16 Set up BFD MAD links between IRF member switches

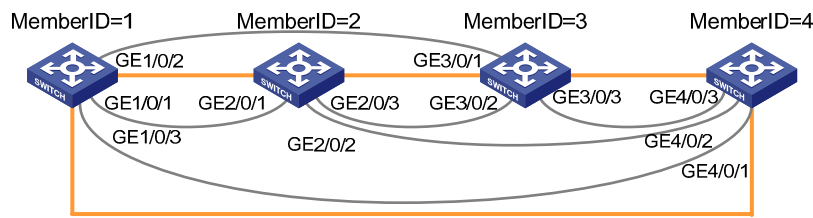

2. Configuration procedure

Use VLAN interface 3 as the dedicated BFD MAD interface, and assign each member switch a MAD IP address from 192.168.2.1 to 192.168.2.4.

Create VLAN 3, and assign all ports of the BFD MAD links to the VLAN.

```
<Sysname> system-view
[Sysname] vlan 3
[Sysname-vlan3] port gigabitEthernet 1/0/1 to gigabitEthernet 1/0/3 gigabitEthernet 2/0/1
to gigabitEthernet 2/0/3 gigabitEthernet 3/0/1 to gigabitEthernet 3/0/3 gigabitEthernet
4/0/1 to gigabitEthernet 4/0/3
```

Create VLAN interface 3, enable BFD MAD, and assign a MAD IP address for each IRF member switch.

```
[Sysname-vlan3] quit
[Sysname] interface vlan-interface 3
[Sysname-Vlan-interface3] mad bfd enable
[Sysname-Vlan-interface3] mad ip address 192.168.2.1 24 member 1
[Sysname-Vlan-interface3] mad ip address 192.168.2.2 24 member 2
[Sysname-Vlan-interface3] mad ip address 192.168.2.3 24 member 3
[Sysname-Vlan-interface3] mad ip address 192.168.2.4 24 member 4
```

Disable the spanning tree function on all ports of the BFD MAD links.

```
[Sysname] interface gigabitEthernet 1/0/1
[Sysname-GigabitEthernet1/0/1] undo stp enable
[Sysname-GigabitEthernet1/0/1] quit
```

```

[Sysname] interface gigabitEthernet 1/0/2
[Sysname-GigabitEthernet1/0/2] undo stp enable
[Sysname-GigabitEthernet1/0/2] quit
[Sysname] interface gigabitEthernet 1/0/3
[Sysname-GigabitEthernet1/0/3] undo stp enable
[Sysname-GigabitEthernet1/0/3] quit
[Sysname] interface gigabitEthernet 2/0/1
[Sysname-GigabitEthernet2/0/1] undo stp enable
[Sysname-GigabitEthernet2/0/2] quit
[Sysname] interface gigabitEthernet 2/0/2
[Sysname-GigabitEthernet2/0/2] undo stp enable
[Sysname-GigabitEthernet2/0/2] quit
[Sysname] interface gigabitEthernet 2/0/3
[Sysname-GigabitEthernet2/0/3] undo stp enable
[Sysname-GigabitEthernet2/0/3] quit
[Sysname] interface gigabitEthernet 3/0/1
[Sysname-GigabitEthernet3/0/1] undo stp enable
[Sysname-GigabitEthernet3/0/1] quit
[Sysname] interface gigabitEthernet 3/0/2
[Sysname-GigabitEthernet3/0/2] undo stp enable
[Sysname-GigabitEthernet3/0/2] quit
[Sysname] interface gigabitEthernet 3/0/3
[Sysname-GigabitEthernet3/0/3] undo stp enable
[Sysname-GigabitEthernet3/0/3] quit
[Sysname] interface gigabitEthernet 4/0/1
[Sysname-GigabitEthernet4/0/1] undo stp enable
[Sysname-GigabitEthernet4/0/1] quit
[Sysname] interface gigabitEthernet 4/0/2
[Sysname-GigabitEthernet4/0/2] undo stp enable
[Sysname-GigabitEthernet4/0/2] quit
[Sysname] interface gigabitEthernet 4/0/3
[Sysname-GigabitEthernet4/0/3] undo stp enable

```

3. Multi-active detection and collision handling

Assume that member switch 2 is the master. When the IRF virtual device is operating normally, only the MAD IP address of the master takes effect. The master cannot set up BFD sessions with other member switches, as shown in Figure 17.

Figure 17 BFD session establishment status before an IRF partition

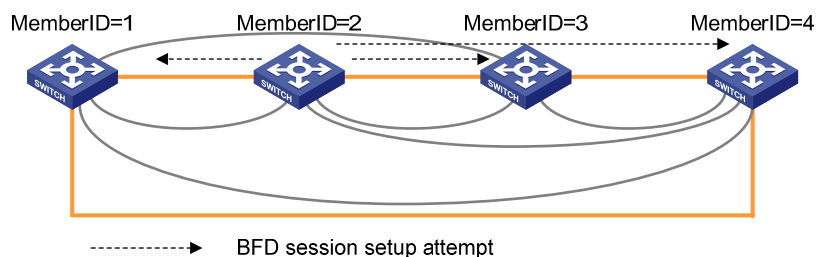

When the IRF link between member switches 1 and 4 fails, the IRF virtual device changes to a daisy chain topology, and no IRF partition occurs. When the IRF link between member switches 2 and 3 also

fails, the IRF virtual device splits in two, the MAD IP addresses of the master switches, switches 2 and 4 for example, in the two IRF virtual devices, take effect, and switches 2 and 4 establish a BFD session between them. The two IRF virtual devices compare their active IDs exchanged through the session. The IRF virtual device that contains Switch 4 finds that it has a higher active ID, and changes to the recovery state, while the IRF virtual device that contains switch 2 remains in the active state and forwards traffic, as shown in Figure 18.

Figure 18 BFD session establishment status after an IRF partition and multi-active collision handling

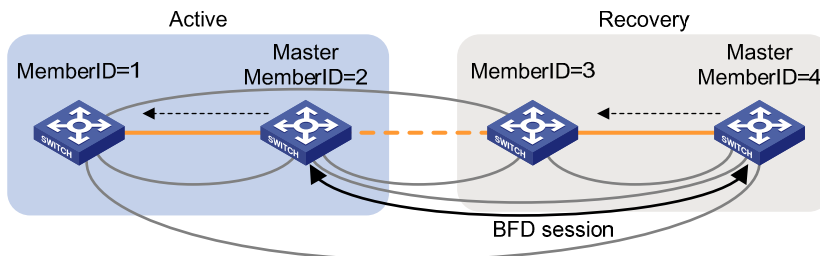

Performing BFD MAD through an intermediate switch

1. Set up BFD MAD links

Set up a BFD link between the intermediate switch and each IRF member switch, as shown in Figure 19. Compared with the other connection approaches, this approach uses fewer ports on the IRF member switches.

Figure 19 Set up BFD MAD links between an intermediate switch and each IRF member switch

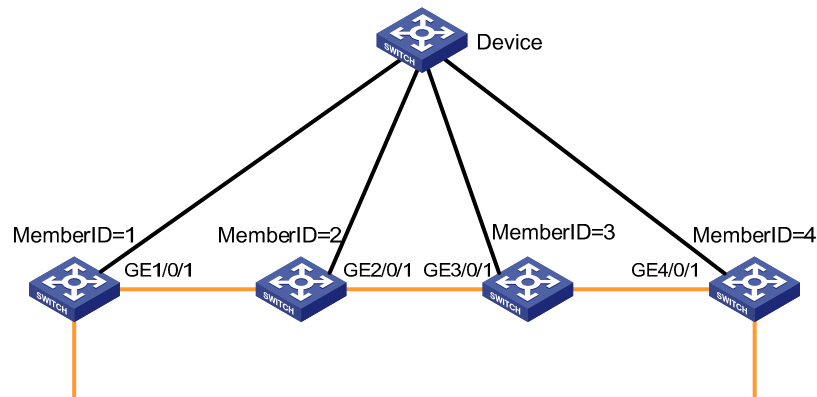

NOTE:

If you perform BFD MAD through an intermediate switch, the BFD MAD configuration is independent of the IRF virtual device topology. The configuration procedure in this example also applies to the daisy chain topology.

2. Configuration procedure

- Configure the IRF virtual device:

Create VLAN 3, and assign all ports of the BFD MAD links to the VLAN.

```
<Sysname> system-view
```

```
[Sysname] vlan 3
```

```
[Sysname-vlan3] port gigabitethernet 1/0/1 gigabitethernet 2/0/1 gigabitethernet 3/0/1
gigabitethernet 4/0/1
```

Create VLAN interface 3, enable BFD MAD, and assign a MAD IP address for each IRF member switch.

```
[Sysname-vlan3] quit
[Sysname] interface vlan-interface 3
[Sysname-Vlan-interface3] mad bfd enable
[Sysname-Vlan-interface3] mad ip address 192.168.2.1 24 member 1
[Sysname-Vlan-interface3] mad ip address 192.168.2.2 24 member 2
[Sysname-Vlan-interface3] mad ip address 192.168.2.3 24 member 3
[Sysname-Vlan-interface3] mad ip address 192.168.2.4 24 member 4
```

Disable the spanning tree function on all ports of the BFD MAD links.

```
[Sysname] interface gigabitethernet 1/0/1
[Sysname-GigabitEthernet1/0/1] undo stp enable
[Sysname-GigabitEthernet1/0/1] quit
[Sysname] interface gigabitethernet 2/0/1
[Sysname-GigabitEthernet2/0/1] undo stp enable
[Sysname-GigabitEthernet2/0/2] quit
[Sysname] interface gigabitethernet 3/0/1
[Sysname-GigabitEthernet3/0/1] undo stp enable
[Sysname-GigabitEthernet3/0/1] quit
[Sysname] interface gigabitethernet 4/0/1
[Sysname-GigabitEthernet4/0/1] undo stp enable
```

- Configure the intermediate switch:

Create VLAN 3, and assign the ports (GigabitEthernet 1/0/1 to GigabitEthernet 1/0/4) connected to the IRF member switches to the VLAN.

```
<Device> system-view
[Device] vlan 3
[Device-vlan3] port gigabitethernet 1/0/1 to gigabitethernet 1/0/4
```

3. Multi-active detection and collision handling

The intermediate switch transparently forwards BFD packets. BFD MAD works in the same way as if the member switches were directly connected by BFD MAD links.

ARP MAD Configuration Examples

You can perform ARP MAD by setting up one ARP MAD link with an intermediate switch for each IRF member switch, or setting up ARP MAD links between IRF member switches. In the former approach, you can use data links as ARP MAD links. In the latter approach, you can avoid the failure of the intermediate switch affecting ARP MAD, but must set up dedicated ARP MAD links between IRF member switches.

Performing ARP MAD through an intermediate switch

1. Select data links for ARP MAD

If each switch in your IRF virtual device has one link to the upper-layer device (see [Figure 13](#)) and MSTP is used for removing loops, use these links for ARP MAD.

Figure 20 Perform ARP MAD through an intermediate switch

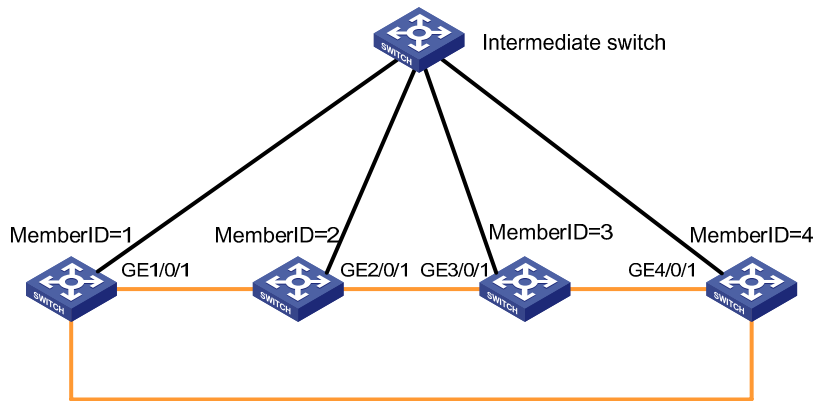

NOTE:

- If you perform ARP MAD through an intermediate switch, the ARP MAD configuration is independent of the IRF virtual device topology. The configuration procedure in this example also applies to the daisy chain topology.
- If the links to the intermediate device are aggregated by LACP, use LACP MAD.

2. Configuration procedure

- Configure the IRF virtual device:

Enable MSTP globally to prevent loops.

```
<Sysname> system-view  
[Sysname] stp enable
```

Enable the IRF virtual device to change its bridge MAC address as soon as the master leaves.

```
[Sysname] undo irf mac-address persistent
```

Create VLAN 3, and assign the ports (GigabitEthernet 1/0/1 to GigabitEthernet 4/0/1) of the ARP MAD links to the VLAN.

```
[Sysname] vlan 3  
[Sysname-vlan3] port gigabitethernet 1/0/1 gigabitethernet 2/0/1 gigabitethernet 3/0/1  
gigabitethernet 4/0/1  
[Sysname-vlan3] quit
```

Create VLAN interface 3, assign it an IP address, and enable ARP MAD.

```
[Sysname] interface vlan-interface 3  
[Sysname-Vlan-interface3] ip address 192.168.0.1 24  
[Sysname-Vlan-interface3] mad arp enable  
[Sysname-Vlan-interface3] quit
```

- Configure the intermediate switch:

Enable MSTP globally to prevent loops.

```
<Device> system-view  
[Device] stp enable
```

Create VLAN 3, and assign the ports (GigabitEthernet 1/0/1 to GigabitEthernet 1/0/4) connected to the IRF member switches to the VLAN.

```
[Device] vlan 3  
[Device-vlan3] port gigabitethernet 1/0/1 to gigabitethernet 1/0/4
```

3. Multi-active detection and collision handling

The intermediate switch transparently forwards gratuitous ARP packets. ARP MAD works in the same way as if the member switches were directly connected by ARP MAD links.

Suppose member switch 2 is the master switch. When the IRF virtual device is operating normally, MSTP blocks all links between the intermediate switch and the IRF virtual device but the one between the intermediate switch and member switch 1. No gratuitous ARP packets are transmitted between IRF member switches.

When the IRF link between member switches 1 and 4 fails, the IRF virtual device changes to a daisy chain topology, and no IRF partition occurs. When the IRF link between member switches 2 and 3 also fails, the IRF virtual device splits in two: one contains switches 1 and 2, and one contains switches 3 and 4. MSTP recalculates the topology, and places the links that connect the intermediate switch and IRF member switches 1 and 3 in forwarding state. Switches 1 and 3 receive gratuitous ARP packets from each other. Their respective IRF virtual devices compare the local active ID with the active ID in the received gratuitous ARP packets. The IRF virtual device that contains Switch 3 finds that it has a higher active ID, and changes to the recovery state, while the IRF virtual device that contains switch 1 remains in the active state and forwards traffic, as shown in

Figure 21 Multi-active detection and collision handling with ARP MAD

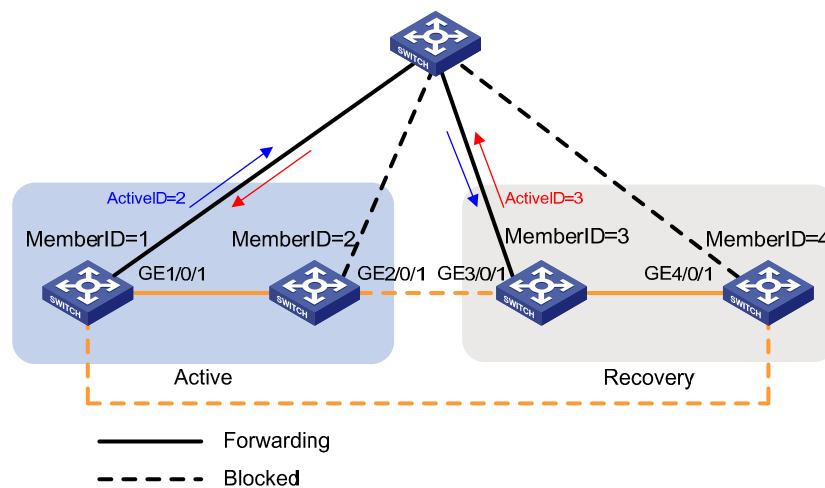

Performing ARP MAD without any intermediate switch (daisy chain topology)

1. Set up ARP MAD links

Set up an ARP MAD link between every two IRF member switches, as shown in [Figure 22](#).

Figure 22 Set up ARP MAD links between IRF member switches in the daisy chain topology

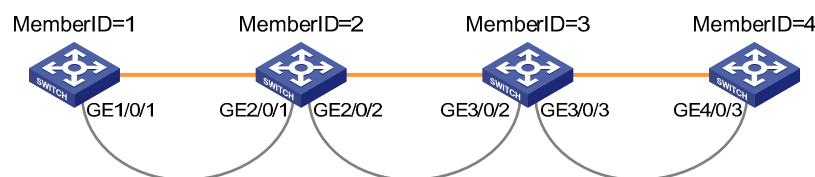

2. Configuration procedure

Use VLAN interface 3 as the dedicated ARP MAD detection interface, and assign it the IP address 192.168.0.1/24.

Enable the IRF virtual device to change its bridge MAC address as soon as the master leaves.

```
<Sysname> system-view
```

```

[Sysname] undo irf mac-address persistent

# Create VLAN 3, and assign all ports of the ARP MAD links to the VLAN.
[Sysname] vlan 3
[Sysname-vlan3] port gigabitethernet 1/0/1 gigabitethernet 2/0/1 gigabitethernet 2/0/2
gigabitethernet 3/0/2 gigabitethernet 3/0/3 gigabitethernet 4/0/3

# Create VLAN interface 3, assign it an IP address, and enable ARP MAD.
[Sysname-vlan3] quit
[Sysname] interface vlan-interface 3
[Sysname-Vlan-interface3] ip address 192.168.0.1 24
[Sysname-Vlan-interface3] mad arp enable
[Sysname-Vlan-interface3] quit

```

3. Multi-active detection and collision handling

Assume that switch 2 is the master. When the IRF virtual device is operating normally, the gratuitous ARP packets sent by all member switches carry active ID 2.

When the IRF link between switch 1 and 2 fails, member switch 1 forms an independent IRF virtual device, and its gratuitous ARP packets carry active ID 1, while the gratuitous ARP packets sent by the other switches still carry active ID 2. ARP MAD compares the active IDs, and sets the IRF virtual device that has a higher active ID in the recovery state. In this example, the IRF virtual device that has switch 1 remains in the active state, and the other IRF virtual device changes to the recovery state.

Figure 23 Multi-active collision detection and handling with ARP MAD

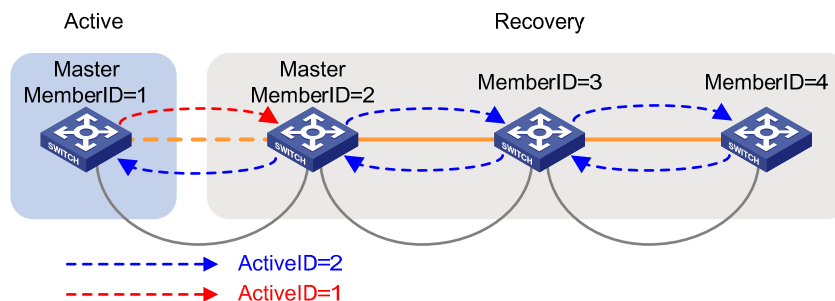

Performing ARP MAD without any intermediate switch (ring topology)

1. Set up ARP MAD links

Set up ARP MAD links between every two neighbor switches, as shown in Figure 24.

Figure 24 Set up ARP MAD links between IRF member switches in the ring topology

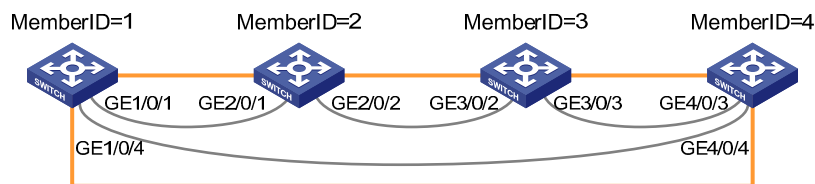

2. Configuration procedure

Use VLAN interface 3 as the dedicated ARP MAD interface, and assign it the IP address 192.168.0.1/24.

Enable the IRF virtual device to change its bridge MAC address as soon as the master leaves.

```
<Sysname> system-view
```

```
[Sysname] undo irf mac-address persistent

# Create VLAN 3, and assign all ports of the ARP MAD links to the VLAN.
[Sysname] vlan 3
[Sysname-vlan3] port gigabitethernet 1/0/1 gigabitethernet 1/0/4 gigabitethernet 2/0/1
gigabitethernet 2/0/2 gigabitethernet 3/0/2 gigabitethernet 3/0/3 gigabitethernet 4/0/3
gigabitethernet 4/0/4

# Create VLAN interface 3, assign it an IP address, and enable ARP MAD.
[Sysname-vlan3] quit
[Sysname] interface vlan-interface 3
[Sysname-Vlan-interface3] ip address 192.168.0.1 24
[Sysname-Vlan-interface3] mad arp enable
[Sysname-Vlan-interface3] quit
```

3. Multi-active detection and collision handling

If any two IRF links in the IRF virtual device fail, the IRF virtual device splits in two. ARP MAD detects and handles the multi-active collision as in the daisy chain topology.

Hybrid MAD Configuration Example

You can use several MAD methods for your IRF virtual device, when one method cannot monitor all IRF links. For example, you can use LACP MAD and BFD MAD for the IRF virtual device shown in [Figure 25](#).

Setting up MAD links

Figure 25 An IRF virtual device that uses multiple MAD methods

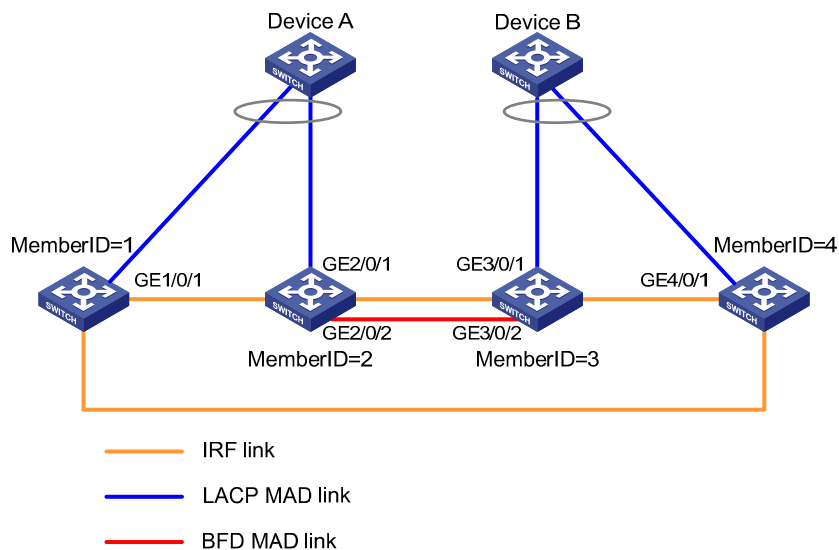

Set up LACP MAD links between Device A and IRF member switches 1 and 2, and between Device B and IRF member switches 3 and 4. Set up a BFD MAD link between IRF member switches 2 and 3.

Configuration procedure

- Configure the IRF virtual device:

```
# Create the dynamic Layer 2 aggregate interface Bridge-aggregation 2, and enable LACP MAD.
```

```
<Sysname> system-view
[Sysname] interface bridge-aggregation 2
```

```

[Sysname-Bridge-Aggregation2] link-aggregation mode dynamic
[Sysname-Bridge-Aggregation2] mad enable
[Sysname-Bridge-Aggregation2] quit

# Assign ports GigabitEthernet1/0/1 and GigabitEthernet2/0/1 to the interface Bridge-aggregation
2.
[Sysname] interface gigabitethernet 1/0/1
[Sysname-GigabitEthernet1/0/1] port link-aggregation group 2
[Sysname-GigabitEthernet1/0/1] quit
[Sysname] interface gigabitethernet 2/0/1
[Sysname-GigabitEthernet2/0/1] port link-aggregation group 2
[Sysname-GigabitEthernet2/0/1] quit

# Create the dynamic Layer 2 aggregate interface Bridge-aggregation 3, and enable LACP MAD.
[Sysname] interface bridge-aggregation 3
[Sysname-Bridge-Aggregation3] link-aggregation mode dynamic
[Sysname-Bridge-Aggregation3] mad enable
[Sysname-Bridge-Aggregation3] quit

# Assign ports GigabitEthernet 3/0/1 and GigabitEthernet 4/0/1 to the interface Bridge-aggregation
3.
[Sysname] interface gigabitethernet 3/0/1
[Sysname-GigabitEthernet3/0/1] port link-aggregation group 3
[Sysname-GigabitEthernet3/0/1] quit
[Sysname] interface gigabitethernet 4/0/1
[Sysname-GigabitEthernet4/0/1] port link-aggregation group 3
[Sysname-GigabitEthernet4/0/1] quit

# Create VLAN 3, and assign all ports of the BFD MAD links to the VLAN.
[Sysname] vlan 3
[Sysname-vlan3] port gigabitethernet 2/0/2 gigabitethernet 3/0/2

# Create VLAN interface 3, enable BFD MAD, and assign MAD IP addresses for member switch 2 and
3.
[Sysname-vlan3] quit
[Sysname] interface vlan-interface 3
[Sysname-Vlan-interface3] mad bfd enable
[Sysname-Vlan-interface3] mad ip address 192.168.2.2 24 member 2
[Sysname-Vlan-interface3] mad ip address 192.168.2.3 24 member 3

# Disable the spanning tree function on all ports of the BFD MAD links.
[Sysname] interface gigabitethernet 2/0/2
[Sysname-GigabitEthernet2/0/2] undo stp enable
[Sysname-GigabitEthernet2/0/2] quit
[Sysname] interface gigabitethernet 3/0/2
[Sysname-GigabitEthernet3/0/2] undo stp enable
[Sysname-GigabitEthernet3/0/2] quit

```

- Configure the intermediate switches:

```

# Create the dynamic aggregate interface Bridge-aggregation 2, and assign the ports
(GigabitEthernet1/0/1 to GigabitEthernet1/0/2) connected to the IRF member switches 1 and 2 to the
aggregate interface.
<DeviceA> system-view

```

```

[DeviceA] interface bridge-aggregation 2
[DeviceA-Bridge-Aggregation2] link-aggregation mode dynamic
[DeviceA-Bridge-Aggregation2] quit
[DeviceA] interface gigabitethernet 1/0/1
[DeviceA-GigabitEthernet1/0/1] port link-aggregation group 2
[DeviceA-GigabitEthernet1/0/1] quit
[DeviceA] interface gigabitethernet 1/0/2
[DeviceA-GigabitEthernet1/0/2] port link-aggregation group 2
# Create the dynamic aggregate interface Bridge-aggregation 3, and assign the ports
(GigabitEthernet1/0/1 to GigabitEthernet1/0/2) connected to the IRF member switches 3 and 4 to the
aggregate interface.
<DeviceB> system-view
[DeviceB] interface bridge-aggregation 3
[DeviceB-Bridge-Aggregation3] link-aggregation mode dynamic
[DeviceB-Bridge-Aggregation3] quit
[DeviceB] interface gigabitethernet 1/0/1
[DeviceB-GigabitEthernet1/0/1] port link-aggregation group 3
[DeviceB-GigabitEthernet1/0/1] quit
[DeviceB] interface gigabitethernet 1/0/2
[DeviceB-GigabitEthernet1/0/2] port link-aggregation group 3

```

Multi-active detection and collision handling

Each MAD mechanism works independently to detect and handle IRF partition events for its monitored IRF links.