



deploy

# IPv6 and Sensor Networks

## Module 250 IPv6 and Sensor Networks



# Copy ...Rights

- ***This slide set is the ownership of the 6DEPLOY project via its partners***
- ***The Powerpoint version of this material may be reused and modified only with written authorisation***
- ***Using part of this material must mention 6DEPLOY courtesy***
- ***PDF files are available from [www.6deploy.eu](http://www.6deploy.eu)***
- ***Looking for a contact ?***
  - ***Mail to : [martin.potts@martel-consulting.ch](mailto:martin.potts@martel-consulting.ch)***
  - ***Or [bernard.tuy@renater.fr](mailto:bernard.tuy@renater.fr)***

# Acknowledgements

- Patrick Grosette, Arch Rock



# Agenda

- **Introduction**
- **The Generic Components**
- **Standards and Technologies**
- **An Example – the Arch Rock Portfolio**
- **Deployment Case Studies**
- **Conclusion**

# Background

- Different from most modules in this series
- Need first to define **Wireless Sensor Networks** and show why they are different
- Need to discuss their technology
- Then show where **IPv6 technology** kicks in
- Consider some applications
- Consider a specific product line as example

# The Construction of the Module

- **First we define the different components of Sensor Networks**
- **Then we list some of the standards that are being, or have been, defined for the need**
- **Then we consider a specific portfolio of products from a supplier, Arch Rock, to meet the need**
- **Finally we consider some application environment that have been pursued**

# The Problem

- **Sensors are often small devices, in large numbers, that need to be addressed**
  - They are not powerful, and often have limited power because they are not wired
- **Sensor networks are often wireless, with insufficient power to reach all nodes**
  - They need wireless ad-hoc networks
- **So far many are not even IP-enabled, but are changing**
  - IPv6 is not the only solution for such nets
  - But recent protocols and systems have been developed for them

# What is a “sensor”?

## From Human senses to devices

You feel COLD.



Instruments are more precise. They give us an exact temperature, humidity, heart rate.

Thermometer



Exercise  
Heart Monitor



You feel WET.



You feel your heart pumping!



Rain Gauge

Humidity Meter





# Wireless Sensor Node

- The world is outfitted with billions of devices sensing their environment
- Homes, offices, factories, streets, hospitals, automobiles....people
- Issue:
  - Data is dropped or remains “stranded”



*Wireless Sensor Node* =

Sensor + tiny computer + radio + network

- Sensors: Temperature, humidity, light, vibration, etc.
- Battery operated: Lasts for months or years!
- Tiny computer: As little as you can afford
- Radio communications: No wires needed!
- Internet connected: As easy as opening a web page

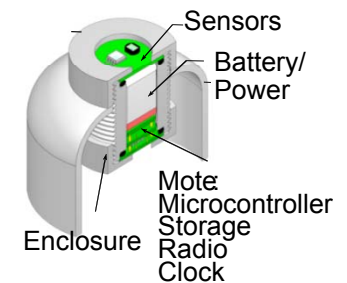

# Sensor Network Technology

- **Sensor nets often wireless towards sensors**
  - **May use Wifi – 802.11**
  - **Often use ZigBee – 802.15.4 (low-power)**
  - **Other technology under development and use**
- **Sensor net gateways often use Web access**
  - **Is good standard for heterogeneity**
- **Sensor net gateways may use different technologies towards Internet**
  - **Often wired – with normal technologies**
  - **Often wireless – e.g. cellular or Wifi**

# Wireless Sensor Network

- Network of small-footprint computers
- Optimised for long-life on low power
- Equipped to sense physical data
- Networked using low-power radio

➤ Function:

- Sense any measurable physical parameter
  - Light, motion, chemicals, proximity, biometrics
- Form “LoWPAN = Low power Wireless Personal Area Network” and communicate
  - Automatic meshing and routing over radio
- Apply user-defined business logic
  - Sampling, summarizing, reporting events

➤ Form:

- Node (Processor, Radio, Storage) + Sensors
- Embedded OS, Networking, Applications
- Servers and Routers interfacing with Enterprise IT systems

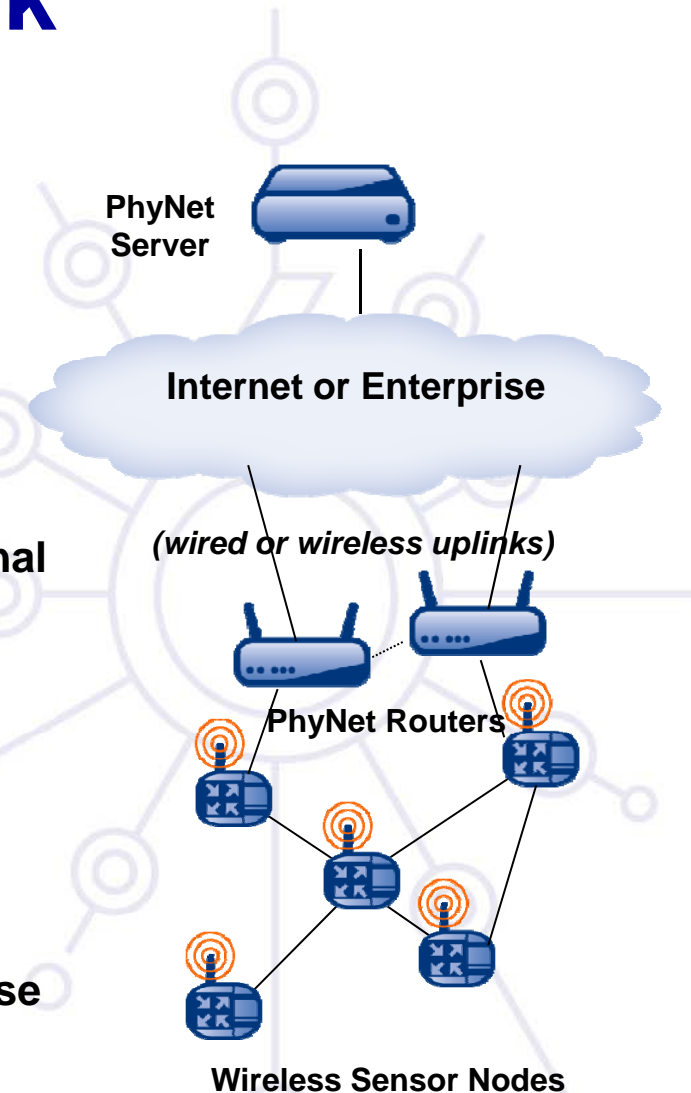

# Sensor Network Characteristics

- Should have an open architecture
  - Needs to fit in with components and sensors from other suppliers
- Need wide range of Nets
  - Different reaches, characteristics, topologies
- Need efficient and low power packet handling – even of small packets
- Need security and ruggedness
- Need minimal external configuration
- **Clearly use of an IP network vital!**

# IP Convergence

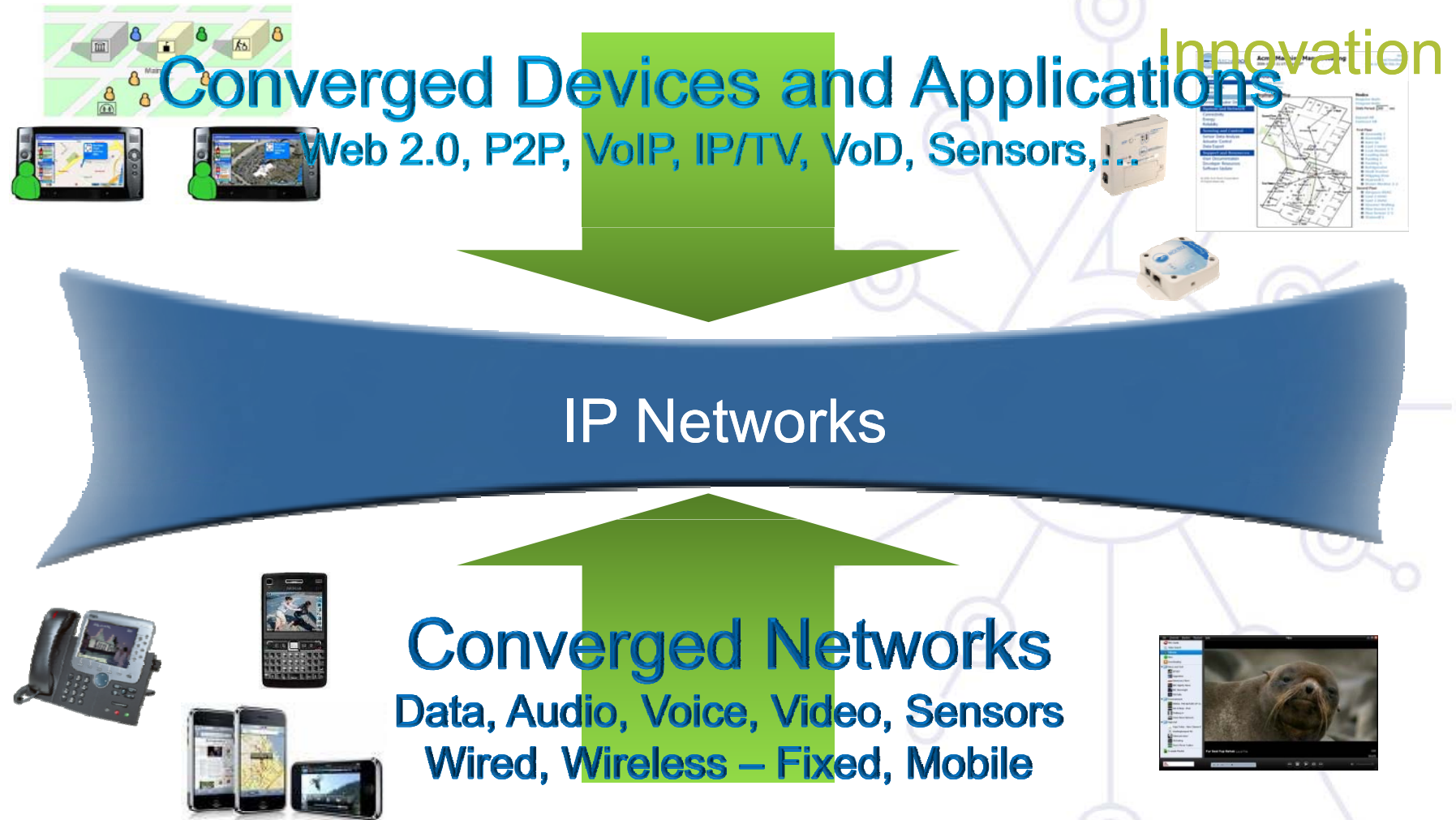

# Sensor Network Architecture

- **Sensors come in many sizes and powers**
    - Some can, but some cannot run IP stack
  - **If they can run stack, new protocols have been optimised for them**
    - Need to address many, hence IPv6 desirable
    - 6LoWPAN for optimal power and packet size
    - Is only defined for IPv6
  - **If they cannot run stack, then sensor gateway used**
    - Addresses and controls data to/from sensors
    - Caches data between Sensor Net and WAN
  - **Topologies may be Star or Mesh**
  - **Traditionally in fixed networks**
    - Mobility patterns are emerging, i.e. Emergency responders
-

# Agenda

- Introduction
- The Generic Components
- Standards and Technologies
- An Example – the Arch Rock Portfolio
- Deployment Case Studies
- Conclusion

# Open Architecture

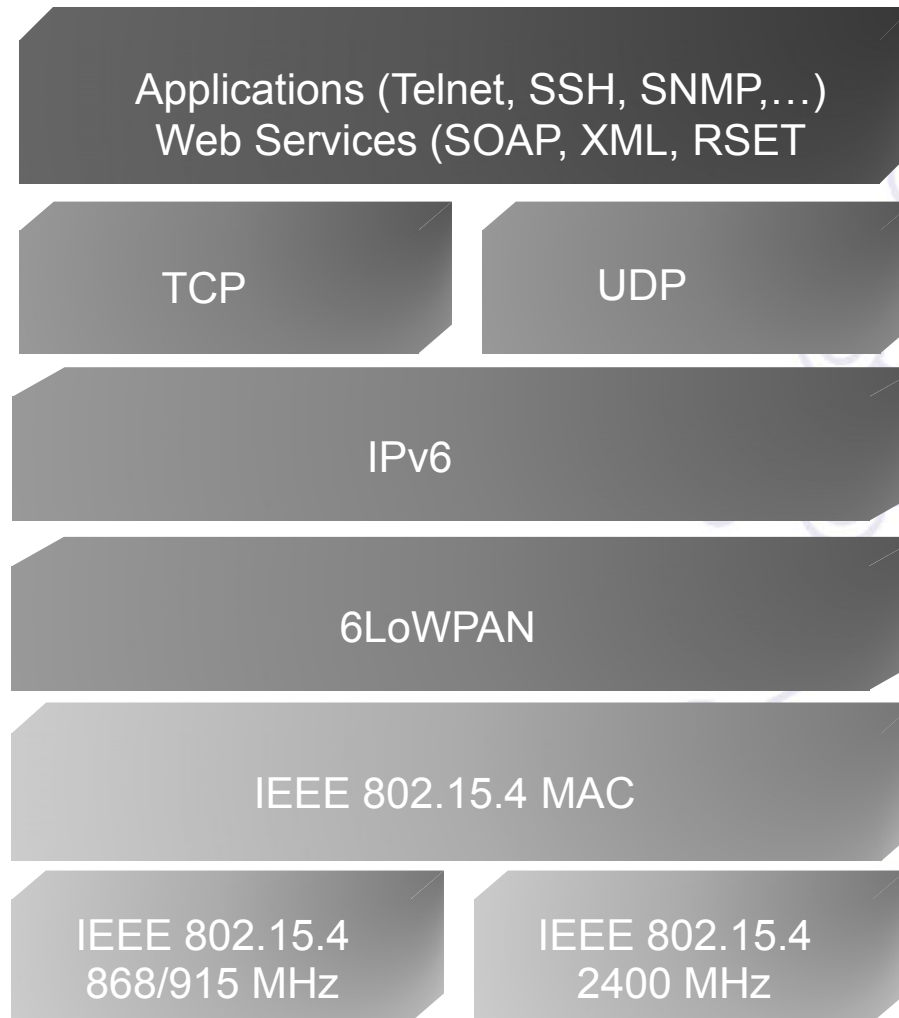





# A Low-Power Standard Link



	802.15.4	802.15.1 (Bluetooth)	802.16 (WiMax)	802.11	802.3
<b>Class</b>	<b>WPAN</b>	<b>WPAN</b>	<b>Metro Area</b>	<b>WLAN</b>	<b>LAN</b>
<b>Lifetime (days)</b>	<b>100-1000+</b>	<b>1-7</b>	<b>Powered</b>	<b>0.1-5</b>	<b>Powered</b>
<b>Net Size</b>	<b>65535</b>	<b>7</b>	<b>P2P, P-MP</b>	<b>30</b>	<b>1024</b>
<b>BW</b>	<b>20-250 Kb/s</b>	<b>720 Kb/s</b>	<b>75Mb/s</b>	<b>11(b)- 108(n)Mb/s</b>	<b>10Mb/s- 10Gb/s</b>
<b>Range (m)</b>	<b>1-100+</b>	<b>1-10+</b>	<b>50K</b>	<b>1-100+</b>	<b>185 (wired)</b>
<b>Goals</b>	<b>Low Power, Large Scale, Low Cost</b>	<b>Cable Replacement</b>	<b>Cable Replacement</b>	<b>Throughput</b>	<b>Throughput</b>

- **Low Transmit power, Low SNR, modest BW, Little Frames**

# IEEE 802.15.4 Physical Layer

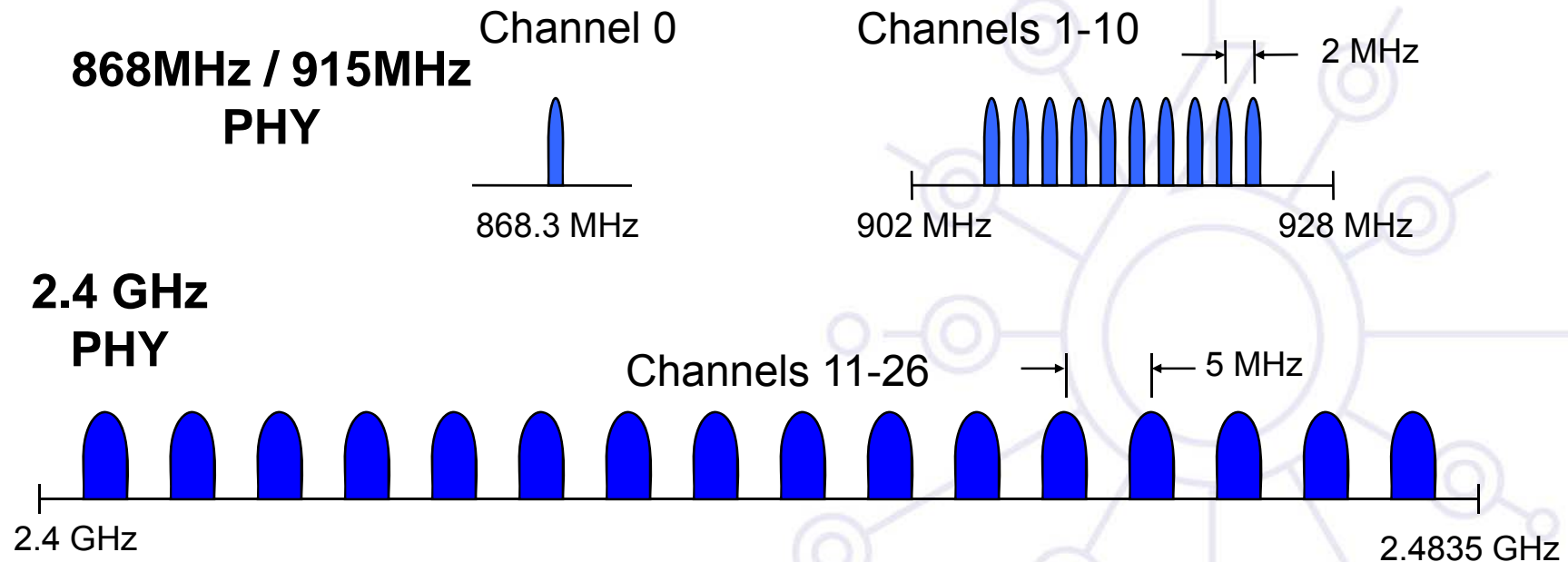

## Frequency Bands of Operation

- 16 channels in the 2.4GHz ISM band
- 10 channels in the 915MHz ISM band
- 1 channel in the European 868MHz band

## Transmit Power

- Capable of at least 1 mW

## Receiver Sensitivity (Packet Error Rate <1%)

- -85 dBm @ 2.4 GHz band
- -92 dBm @ 868/915 MHz band

# IEEE 802.15.4 Physical Layer

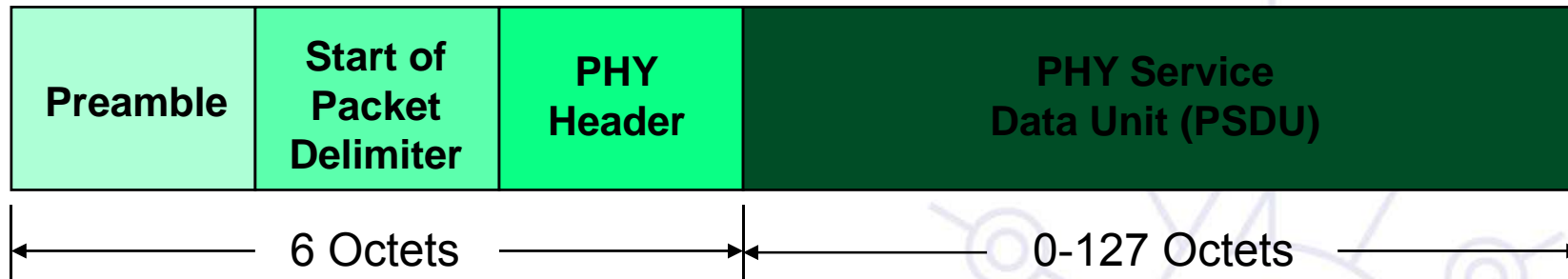

## PHY Packet Fields

- Preamble (32 bits) – synchronization
- Start of Packet Delimiter (8 bits)
- PHY Header (8 bits)
  - Frame Length (7 bits)
  - Reserved (1 bit)
- PSDU (0 to 1016 bits) – Data field

## Frequency Bands

- 2.4 GHz PHY
  - 250 Kb/s (4 bits/symbol, 62.5 Kbaud)
- 868MHz/915MHz PHY
  - 868 MHz Band: 20 Kb/s (1 bit/symbol, 20 Kbaud)
  - 915 MHz Band: 40 Kb/s (1 bit/symbol, 40 Kbaud)

# IEEE 802.15.4 MAC Layer

- **Simple MAC allows for general use**
  - Many TinyOS-based protocols (MintRoute, LQI, CENS Route), TinyAODV, Zigbee, SP100.11, Wireless HART, ...
  - 6LoWPAN => IP
  - Choice among many semiconductor suppliers
- **Defines 4 Types of MAC Frame structure**
  - A beacon frame, used by a coordinator to transmit beacons
  - A data frame, used for all transfers of data – ie: 6LoWPAN
  - An acknowledgment frame, used for confirming successful frame reception
  - A MAC command frame, used for handling all MAC peer entity control transfers

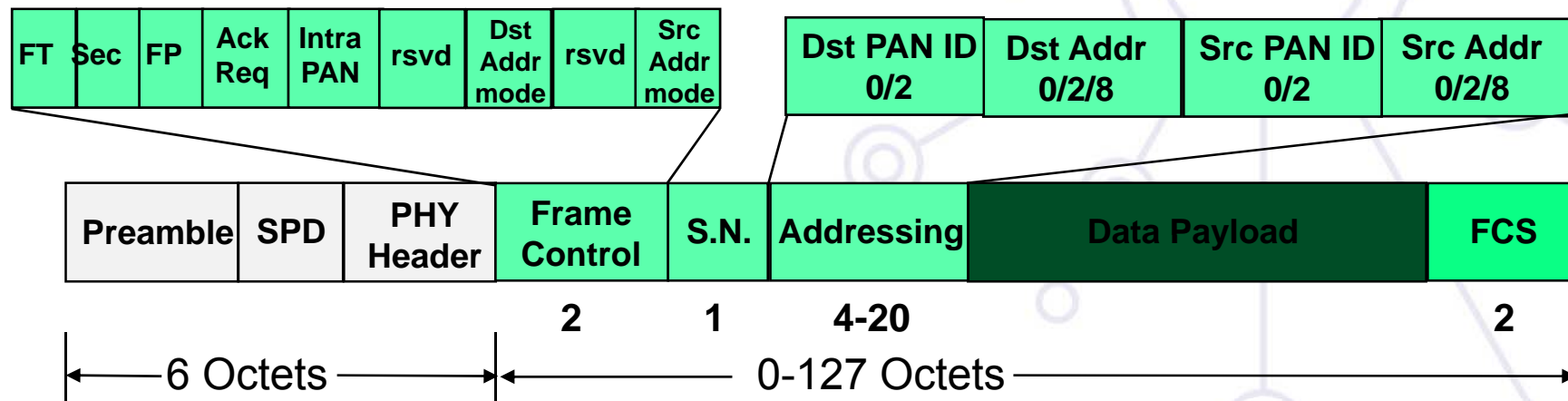

# IEEE 802.15.4 MAC Overview

- **Network Topologies**

Star, Peer-to-Peer, meshed

- **Full function device (FFD)**

Any topology

Network coordinator capable

Talks to any other device

ArchRock nodes are FFD

- **Reduced function device (RFD)**

Limited to star topology

Cannot become a network coordinator

Talks only to a network coordinator

- **Each independent PAN selects a unique identifier**

- **Addressing modes:**

- Network + device identifier (star)
- Source/destination identifier (peer-peer)

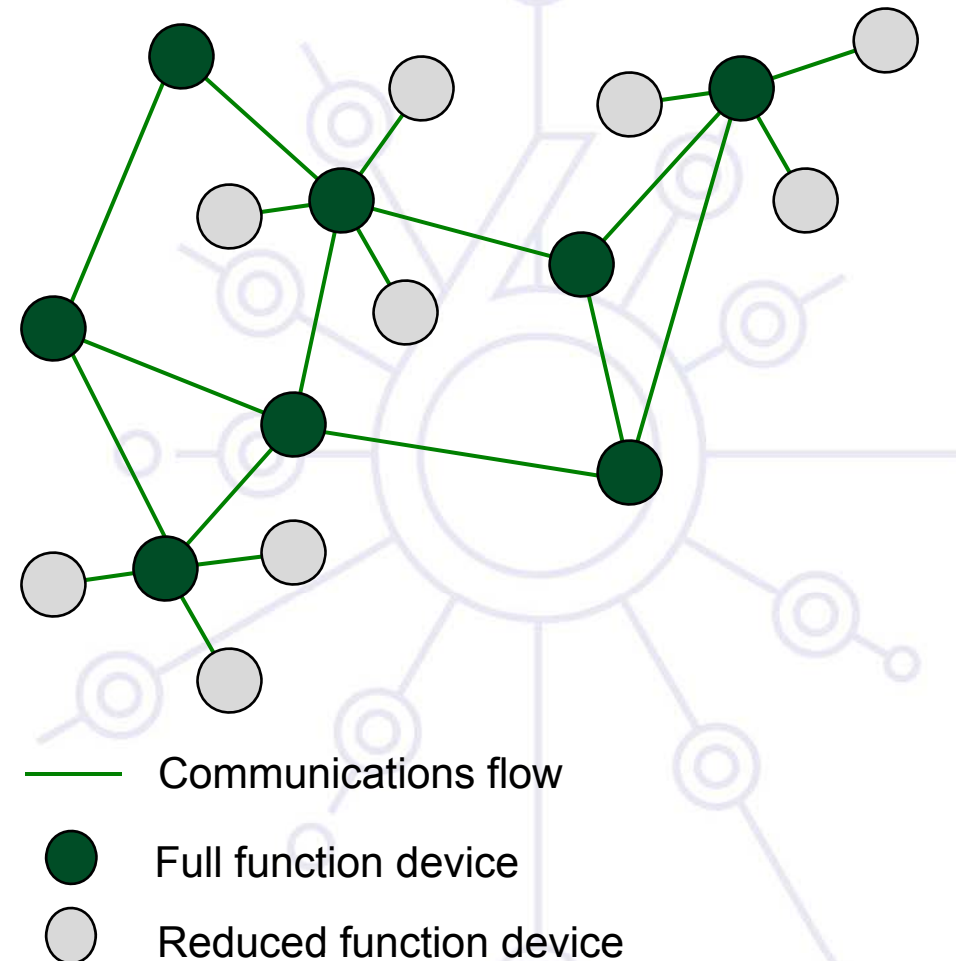

# IETF IPv6 Standards



- **Core IPv6 specifications are stable and well tested IETF Draft Standards**
  - IPv6 Addressing Architecture, ICMPv6, Neighbor Discovery, Stateless Auto-configuration, IPv6 over “Data Link Layers”, DNS Record, Routing Protocols, Tunneling, MIB’s, Header Compression, MLD, etc.
- **2007: IPv6 WG now closed – replaced by 6MAN (Maintenance) WG**
  - <http://www.ietf.org/html.charters/ipv6-charter.html>
- **IPv6 Transition, then now Operations focused Working Groups**
  - NGTrans WG (closed), v6ops (active)
- **Working Groups focusing on Wireless Sensor Networks**
  - 6LoWPAN - IPv6 over Low power Wireless Personal Area Networks  
<http://www.ietf.org/html.charters/6lowpan-charter.html>
  - RoLL - Routing Over Low power and Lossy networks  
<http://www.ietf.org/html.charters/roll-charter.html>



# IPv6 Technology Overview

IP Services	IPv4 solution	IPv6 Solution
Addressing	32 bits, Network Address Translation	128 bits, multiple scopes (global, private, link,...)
Auto-configuration	DHCP	Stateless, DHCP, renumbering
Data Link layers	Ethernet, WiFi, ATM, FR, PPP, Sonet/SDH,...	Ethernet, WiFi, ATM, FR, PPP, Sonet/SDH, 6LoWPAN,...
Routing	RIP, OSPF, IS-IS, E-IGRP, MP-BGP	RIP, OSPF, IS-IS, E-IGRP, MP-BGP, <i>RoLL</i>
IP Network layer Security	IPsec	IPsec
Multicast	IGMP/PIM/Multicast MP-BGP	MLD/PIM/Multicast MP-BGP, <i>Scope Identifier</i>
QoS	Differentiated Service, Integrated Service	Differentiated Service, Integrated Service
Mobility	Mobile IP	Mobile IP with <i>Direct Routing, NEMO</i>

# IPv4 – IPv6 Header Comparison

## IPv4 Header

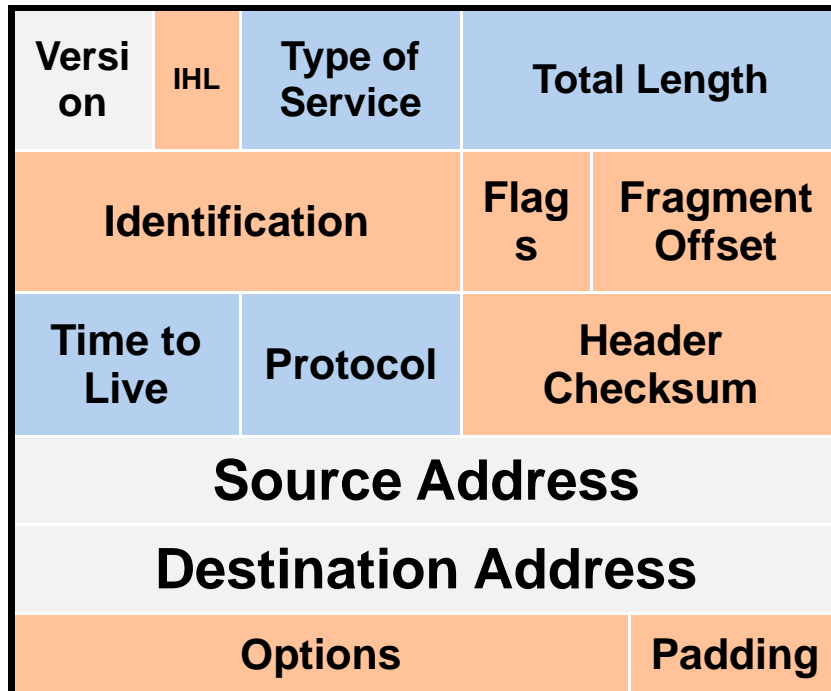

## IPv6 Header

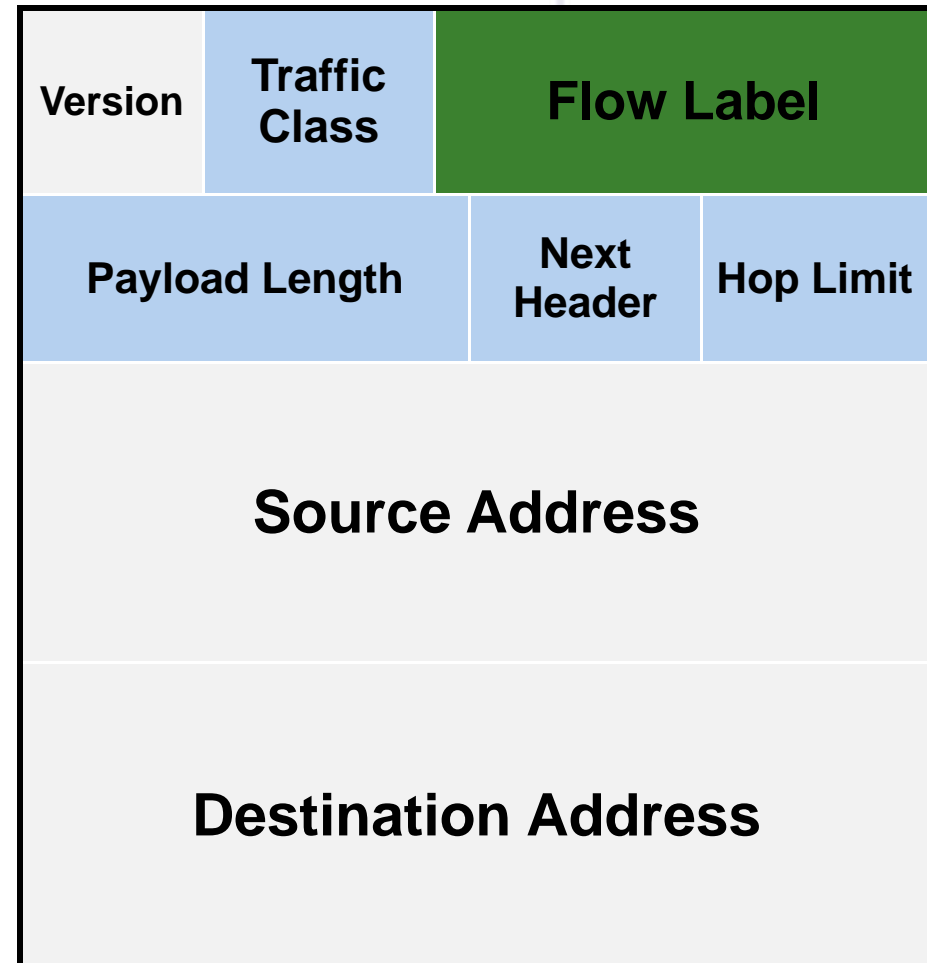

- field's name kept from IPv4 to IPv6
- fields not kept in IPv6
- Name & position changed in IPv6
- New field in IPv6



# IPv6 Address Format

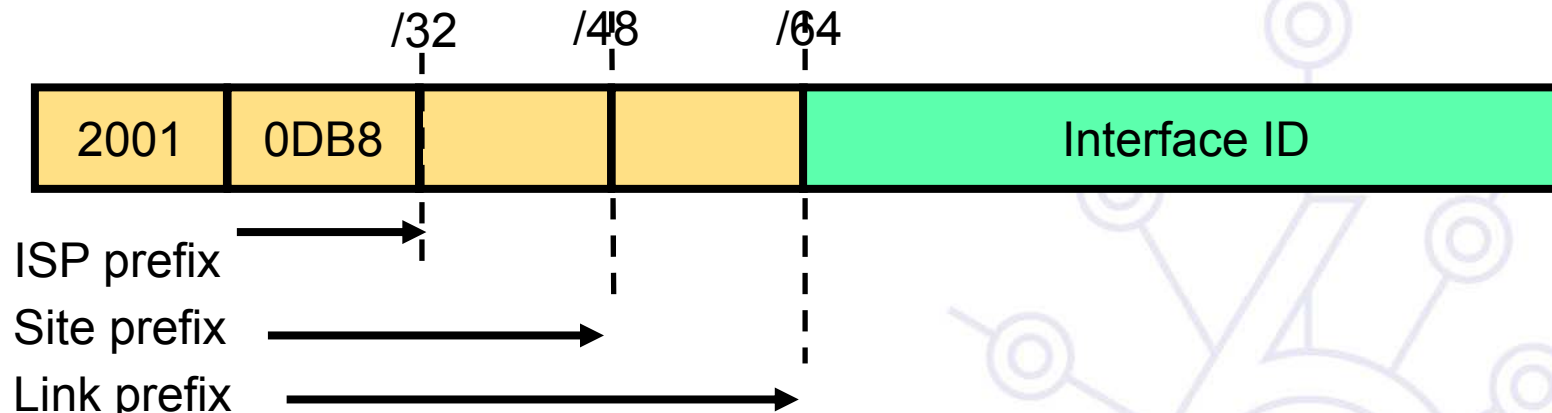

- **The allocation process is defined by the 5 Registries:**
  - IANA allocates 2000::  - Registries get ::/12 prefix(es) from IANA [formerly /23] under new policy <http://www.icann.org/announcements/announcement-12oct06.htm>
  - Registry allocates a /32 prefix [formerly /35] to IPv6 ISP and others large organizations or a /48 for Provider Independent (PI) request (*but RIPE*)
  - Then policies recommend that the ISP allocates a /48 prefix to each customer but it may be /56 or /60 – should avoid /64 per site or will require IPv6 NAT later
  - <http://www.ripe.net/ripe/docs/ipv6policy.html>
  - <http://www.icann.org/announcements/ipv6-report-06sep05.htm>

# IPv6 Address Format

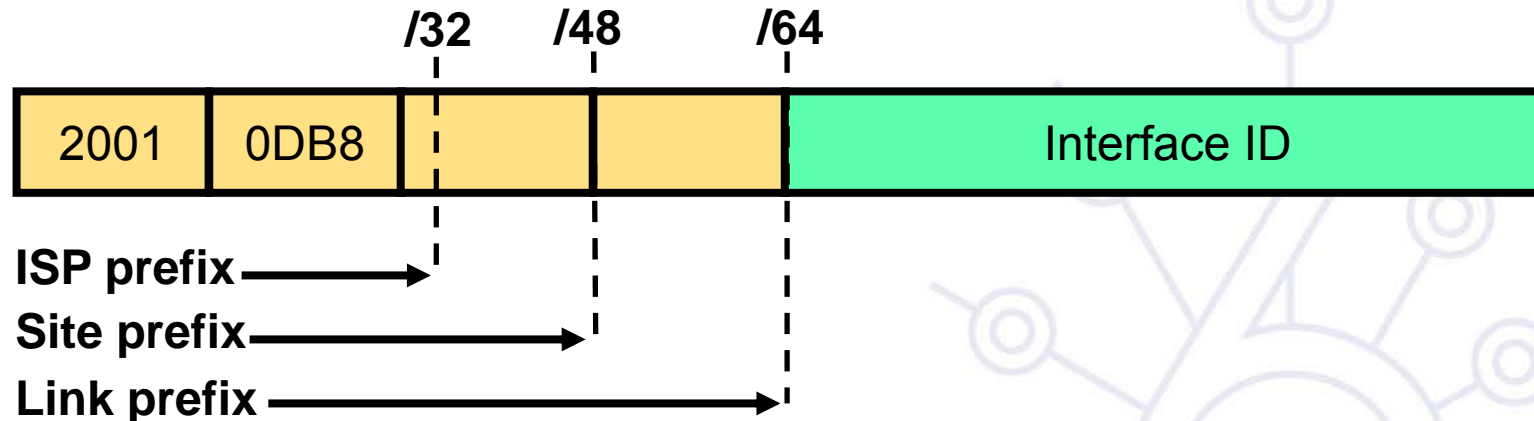

- The allocation process is defined by the 5 Registries:
  - IANA allocates 2000::  - Registries get ::/12 prefix(es) from IANA [formerly /23] under new policy <http://www.icann.org/announcements/announcement-12oct06.htm>
  - Registry allocates a /32 prefix [formerly /35] to IPv6 ISP and others large organizations or a /48 for Provider Independent (PI) request (*but RIPE*)
  - Then policies recommend that the ISP allocates a /48 prefix to each customer but it may be /56 or /60 – should avoid /64 per site or will require IPv6 NAT later
  - <http://www.ripe.net/ripe/docs/ipv6policy.html>
  - <http://www.icann.org/announcements/ipv6-report-06sep05.htm>

# IPv6 Address Configuration

- IPv4 and IPv6



Manually configured

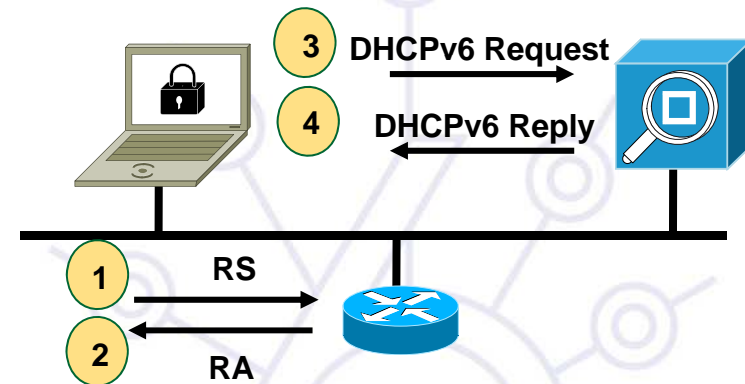

Assigned via DHCP

- IPv6 only

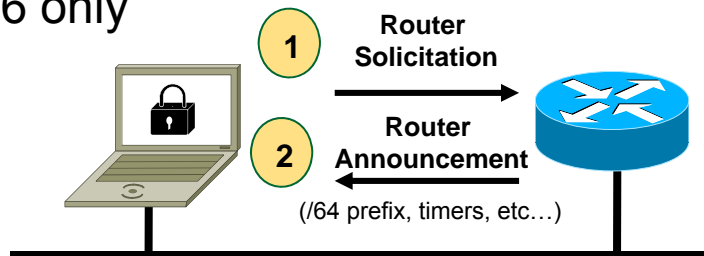

Stateless configuration

IPv6 Address = /64 prefix + Interface ID

- Interface ID field of an Unicast address may be assigned in several different ways, eg. 6LoWPAN

# EUI-64 Format

PAN\* - complement the "Universal/Local" (U/L) bit,  
 Ethernet 48 bits MAC address

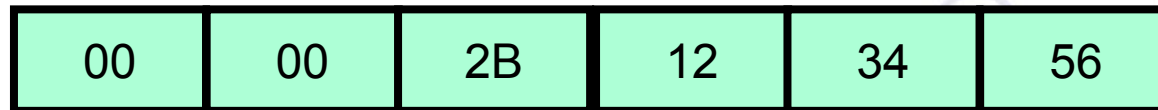

Inserting well known  
padding value

EUI-64

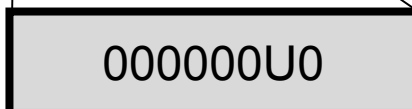

Preserving G/L bit value to identify uniqueness  
 of MAC but inversed value  
 1= Global, 0= Local

# IPv6 Address in 6LoWPAN

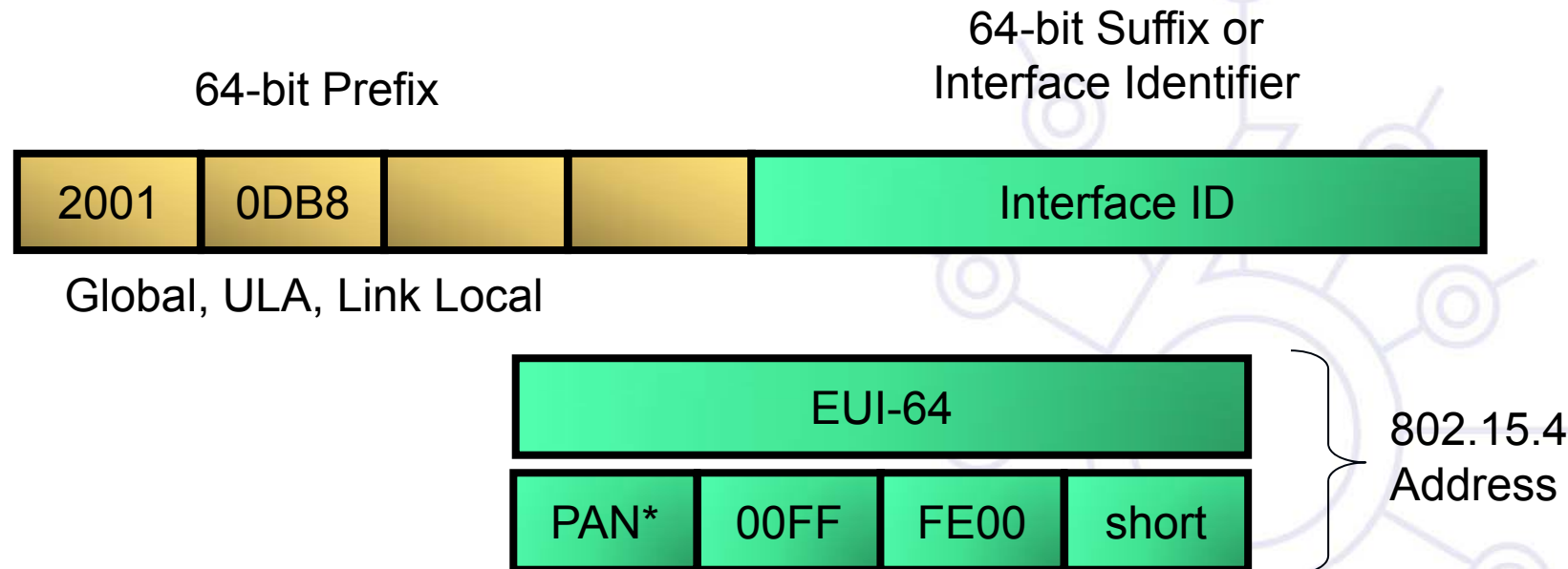

PAN\* - complement the "Universal/Local" (U/L) bit, which is the next-to-lowest order bit of the first octet

**Allow IP routing over a mesh of 802.15.4 nodes**  
**Localized internet of overlapping subnets**

# 6LoWPAN – The First Byte

- Coexistence with other network protocols over same link
- Header dispatch (dsp) - understand what's coming

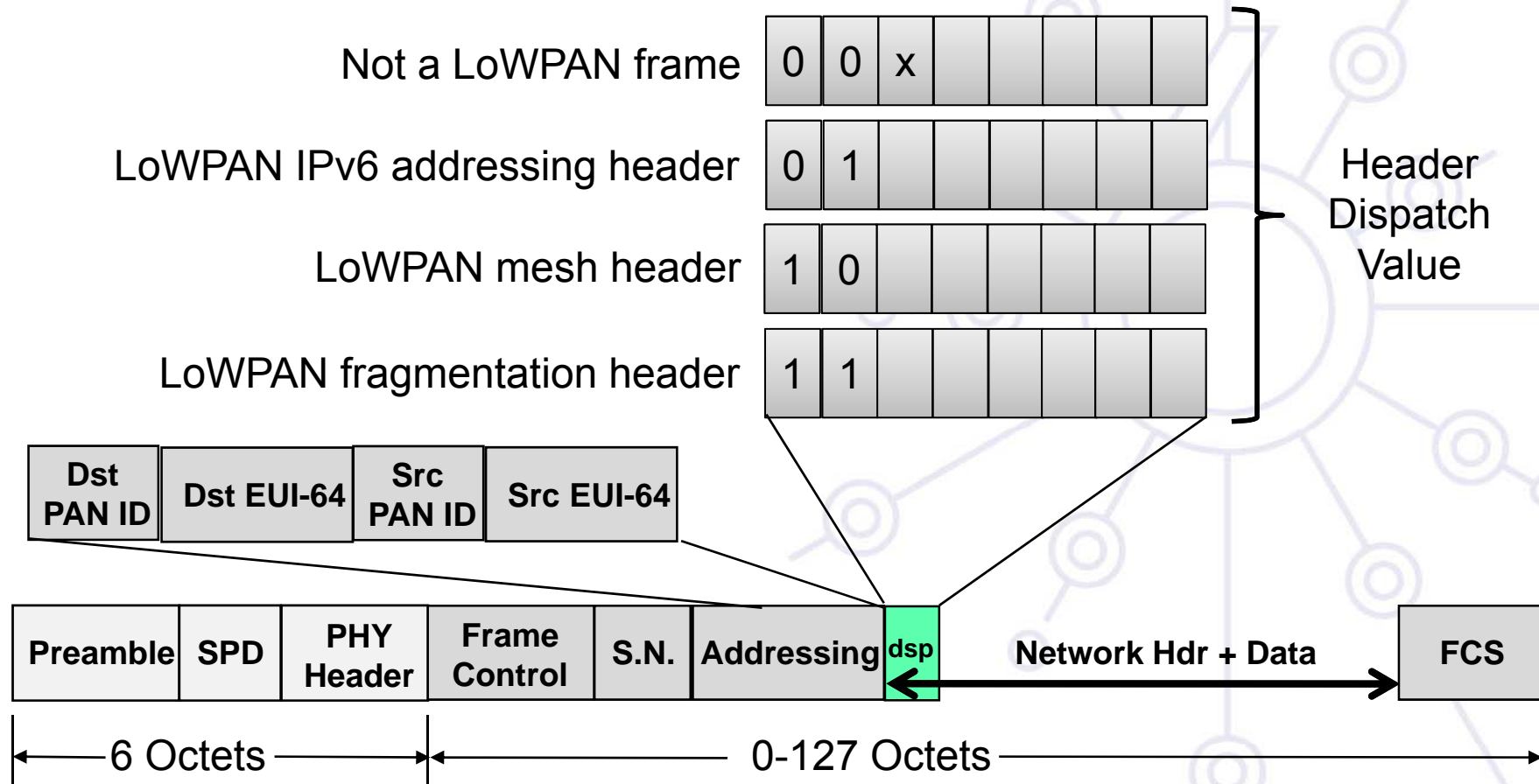

# 6LoWPAN – Adaptation Layer

- RFC 4944 – Almost no overhead for the ability to interoperate and scale
- Standard IPv6 header (40 bytes) vs Entire 802.15.4 MTU (127 bytes)

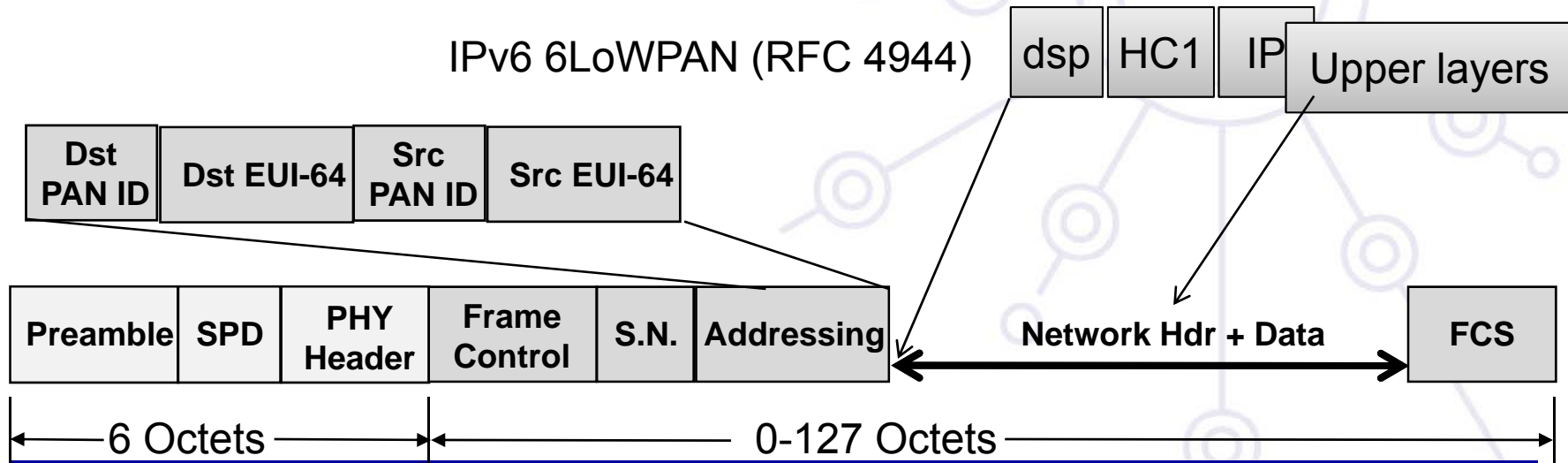

# 6LoWPAN – IPv6 Header

- Uncompressed IPv6 header – 40 Bytes (RFC 2460)
- LoWPAN\_HC1: Compressed Header – 1 Byte

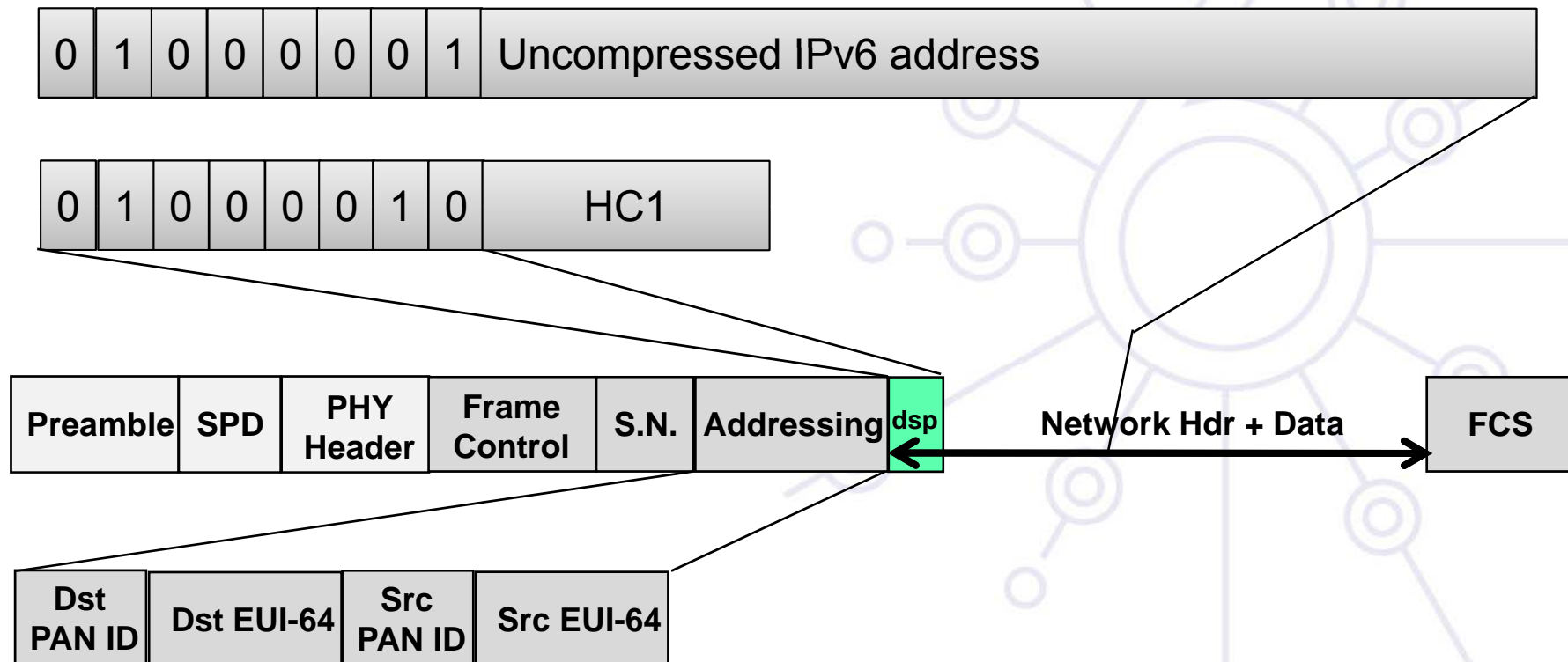



# 6LoWPAN – IPv6 Header Compression

- Standard IPv6 header (40 bytes) vs Entire 802.15.4 MTU (127 bytes)
  - Often data payload is small, Pay for only what you use
- By virtue of having joined the same 6LoWPAN network, devices share some state.
- The IPv6 header values are expected to be common on 6LoWPAN networks, so the HC1 header has been constructed to efficiently compress them from the onset
- Next header: UDP, TCP, or ICMP in a compressed IPv6 Header

## IPv6 Header Compression

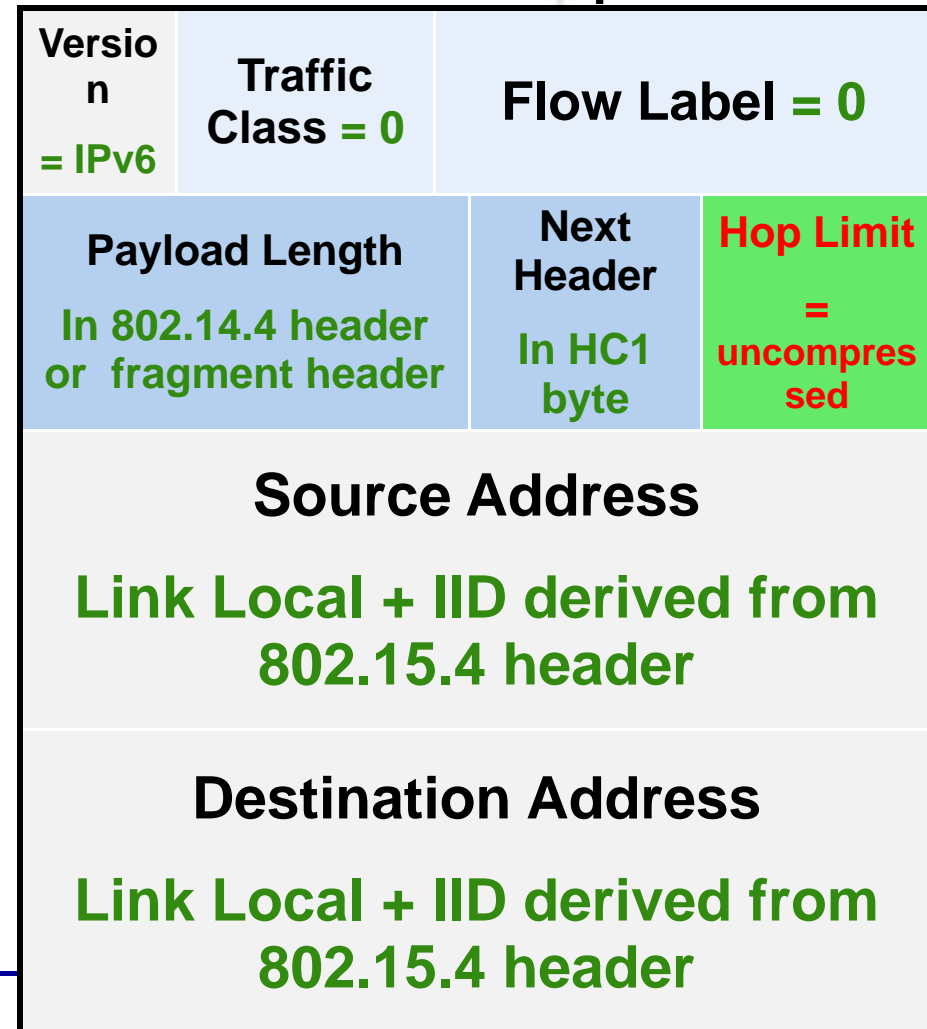

# HC1 Compressed IPv6 Header

- LoWPAN\_HC1: Compressed Header – 1 Byte
- Hop Limit – 1 Byte – can't be compressed
- a=IPv6 source address (bits 0-1), b=IPv6 destination address (bits 2-3)
  - IPv6 Prefix Carried-in-line/compressed, Interface Identifier Carried-in-line/Elided
- c=Traffic Class and Flow Label (bit 4): 0-compressed, 1=Traffic class and Flow label = 0
- d=Next Header (bits 5-6): 00=Not compressed, 10=ICMP, 01=UDP, 11=TCP
- e=HC2 encoding (bit 7): 0=no more compression header, 1= HC2, type determined by "d"

*“compressed IPv6”* (with arrow pointing to 'a')

*“how it is compressed”* (with arrow pointing to 'b')

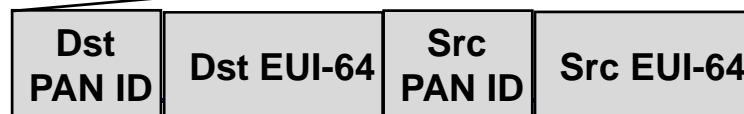
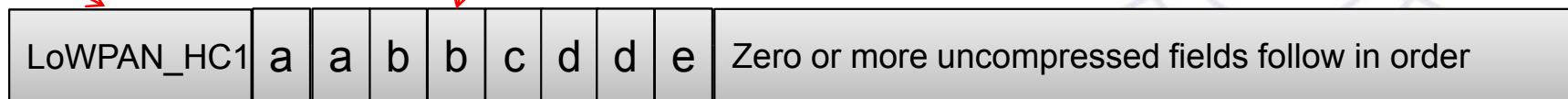

# 6LoWPAN – Compressed/ICMP

- Header Dispatch = compressed
- HC1 = Source & Dest Local, next hdr=ICMP
- IP = Hop Limit
- ICMP = 8-byte header

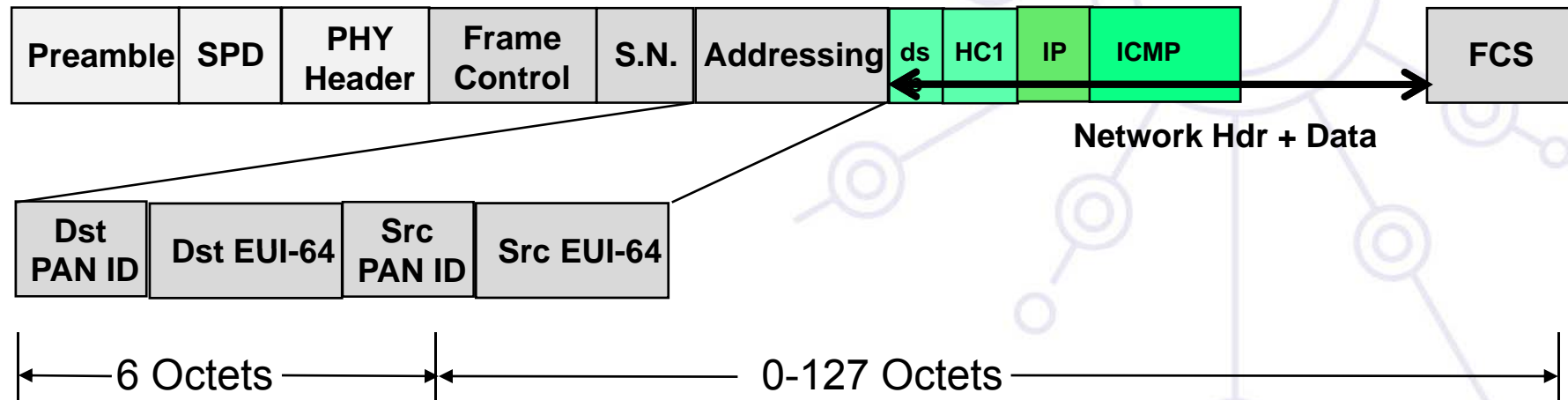

# 6LoWPAN – Compressed/UDP

- Header Dispatch = compressed
- HC1 = Source & Dest Local, next hdr=UDP
- IP = Hop Limit
- UDP = 8-byte header

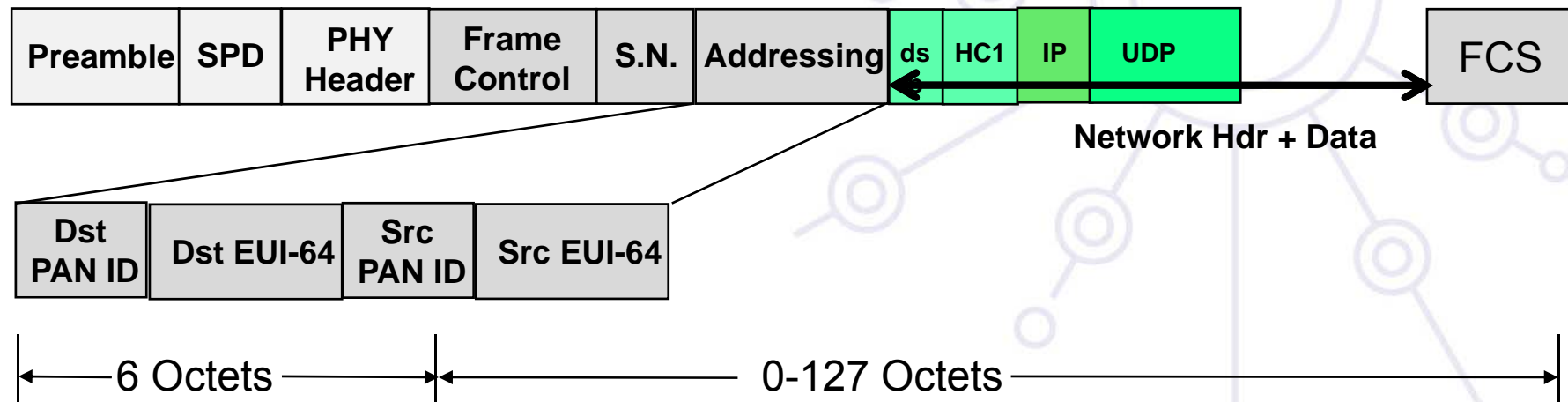

# 6LoWPAN – Compressed/TCP

- Header Dispatch = compressed
- HC1 = Source & Dest Local, next hdr=TCP
- IP = Hop Limit
- TCP = 20-byte header

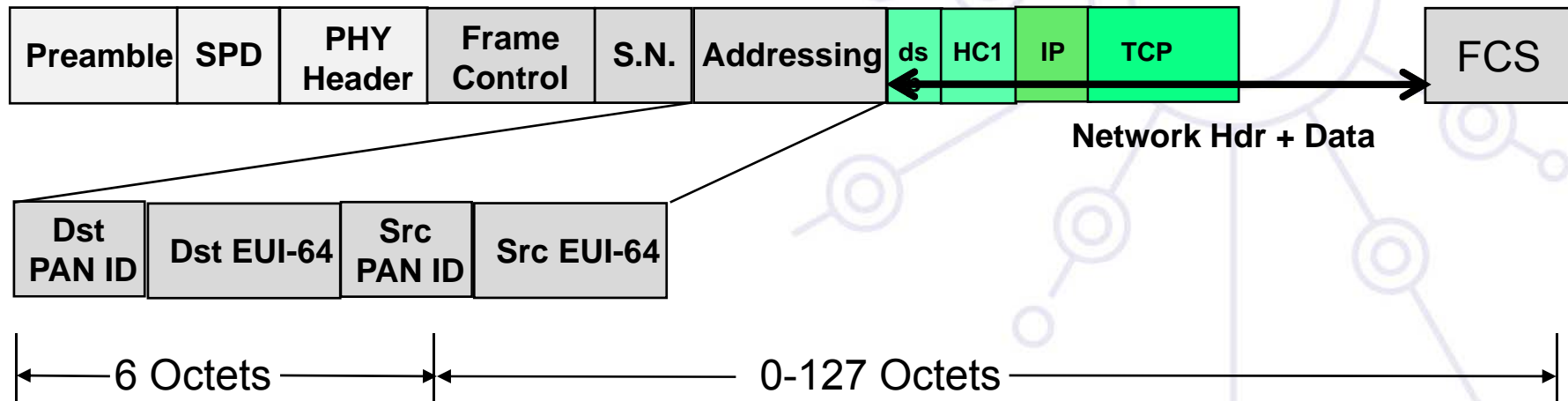

# 6LoWPAN – Fragmentation

- All fragments of an IP packet carry the same “tag”
  - Assigned sequentially at source of fragmentation
- Each subsequent fragment specifies tag, size, and position
- Do not have to arrive in order
- Time limit for entire set of fragments (Reassembly Timeout = 60s [RFC 2460])

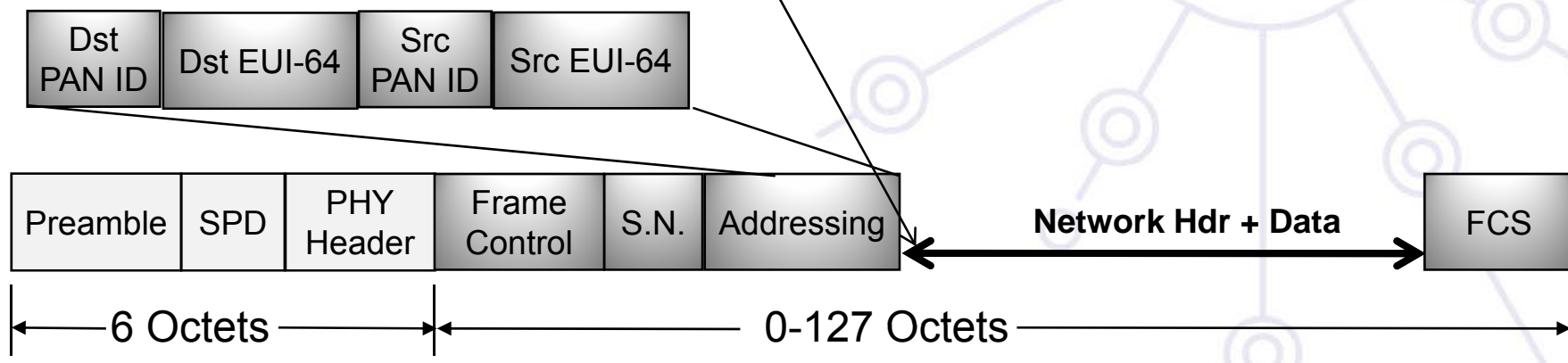

# 6LoWPAN – Fragmentation Example

- Interoperability means that applications need not know the constraints of physical links that might carry their packets
  - IP packets may be large, compared to 802.15.4 max frame size
  - IPv6 requires all links support 1280 byte packets [RFC 2460]
- Example of Fragmented/Compressed/UDP packet
  - Dispatch: Fragmented, First Fragment, Size, Tag
  - Dispatch = compressed IPv6
  - HC1 = Source & Dest Local, next hdr=UDP
  - IP = Hop Limit
  - UDP = 8-byte header

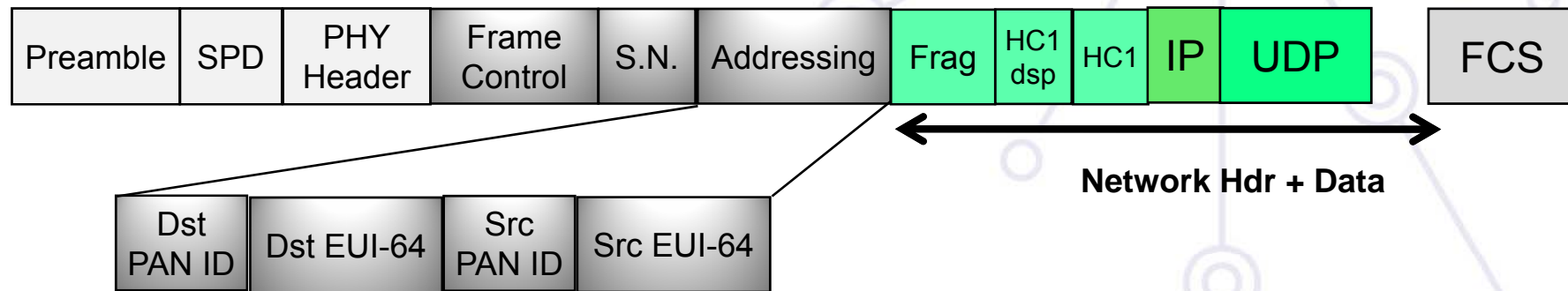

# 6LoWPAN – “Mesh Under”

- Allow link-layer mesh routing under IP topology
  - 802.15.4 subnets may utilize multiple radio hops per IP hop
  - Similar to LAN switching within IP routing domain in Ethernet
- Originating node and Final node specified by either short or EUI-64 address
  - In addition to IP source and destination
  - V = Very First, F = Final – 0= EUI-64, 1= short
- Hops Left (4 bits) – up to 14 hops, then add byte (indicated by 0xF) if more hops
- Mesh protocol determines node at each mesh hop

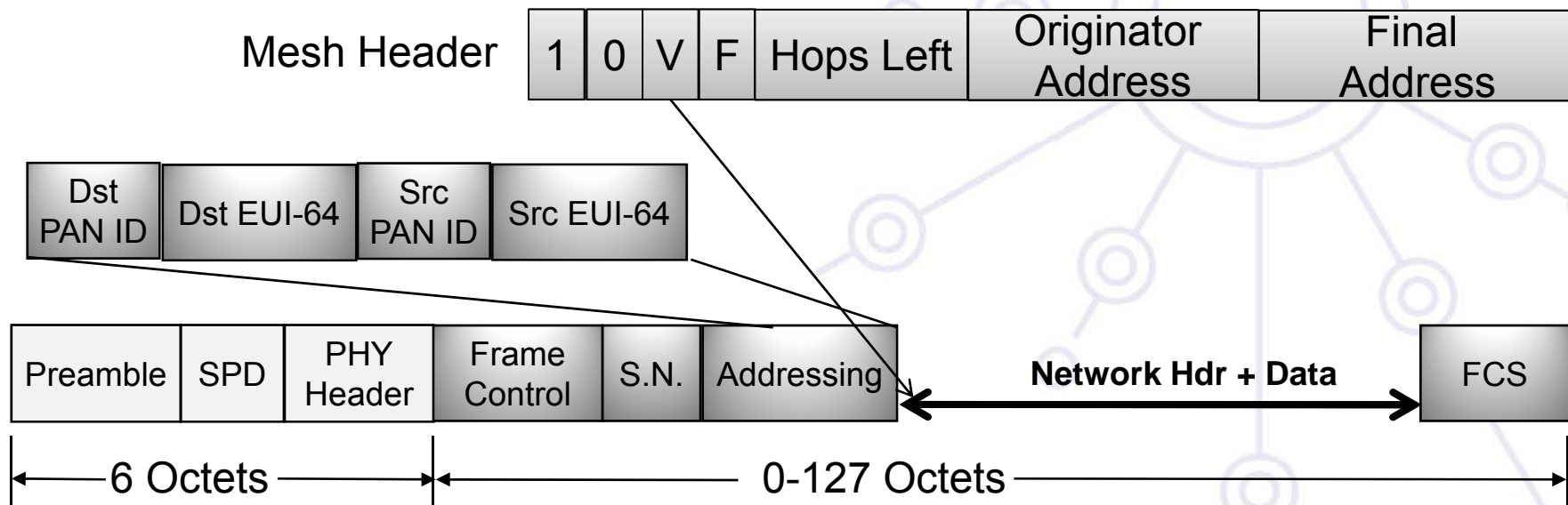



# 6LoWPAN – Mesh Example

## ■ Example of Mesh/Compressed/UDP packet

- Dispatch: Mesh Under, Very First=short, Final=short
  - Mesh= Originator Address, Final Address
  - Hops Left = 5
- Dispatch = compressed IPv6
- HC1 = Source & Dest Local, next hdr=UDP
- IP = Hop Limit
- UDP = 8-byte header

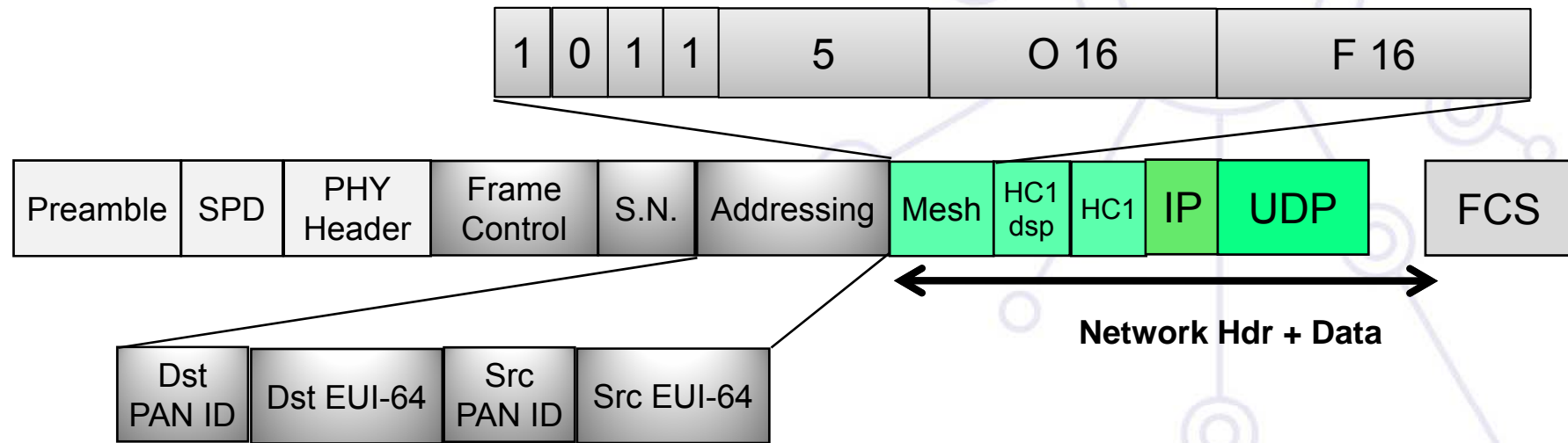

# 6LoWPAN – Mesh Example

## ■ Example of Mesh/Fragmented/Compressed/UDP packet

- Dispatch: Mesh Under, Very First=short, Final=short
  - Mesh= Originator Address, Final Address
  - Hops Left = 5
- Dispatch: Fragmented, First Fragment, Size, Tag
- Dispatch = compressed IPv6
- HC1 = Source & Dest Local, next hdr=UDP
- IP = Hop Limit
- UDP = 8-byte header

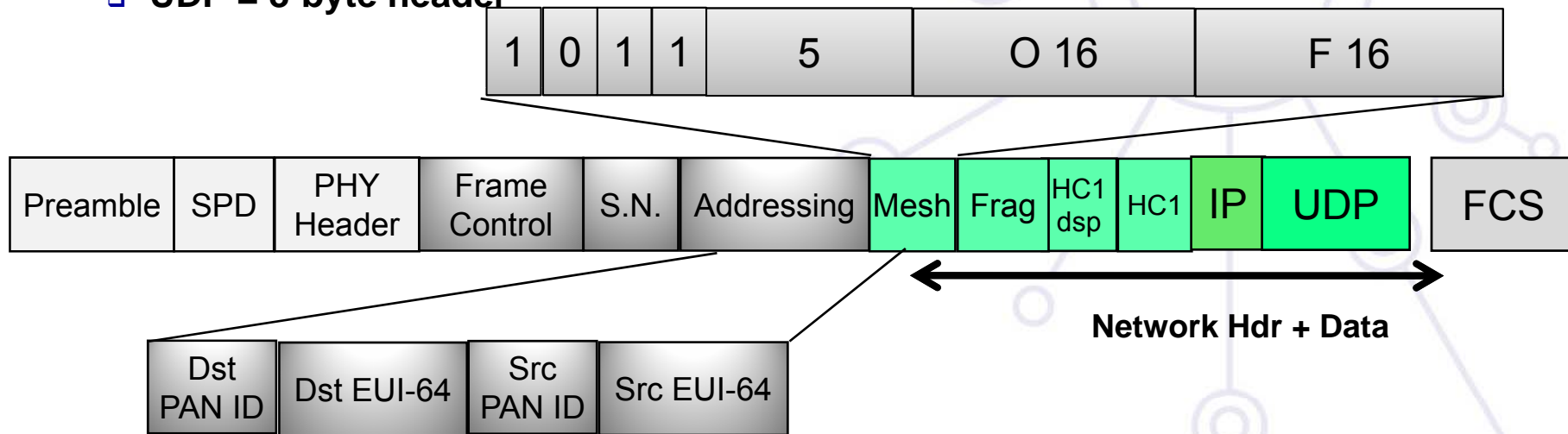

# Self-Configuring WSN

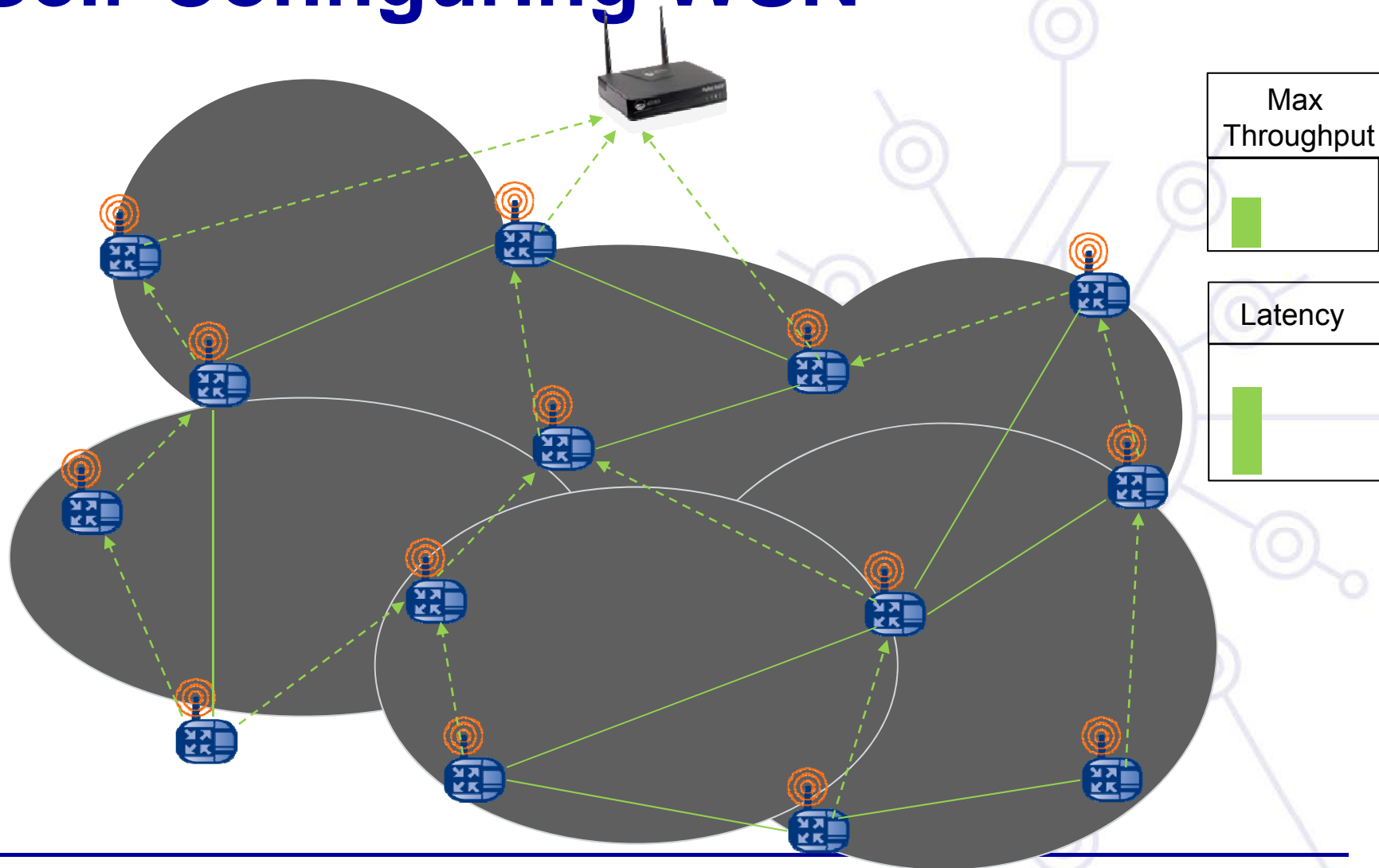

# Scaling the WSN

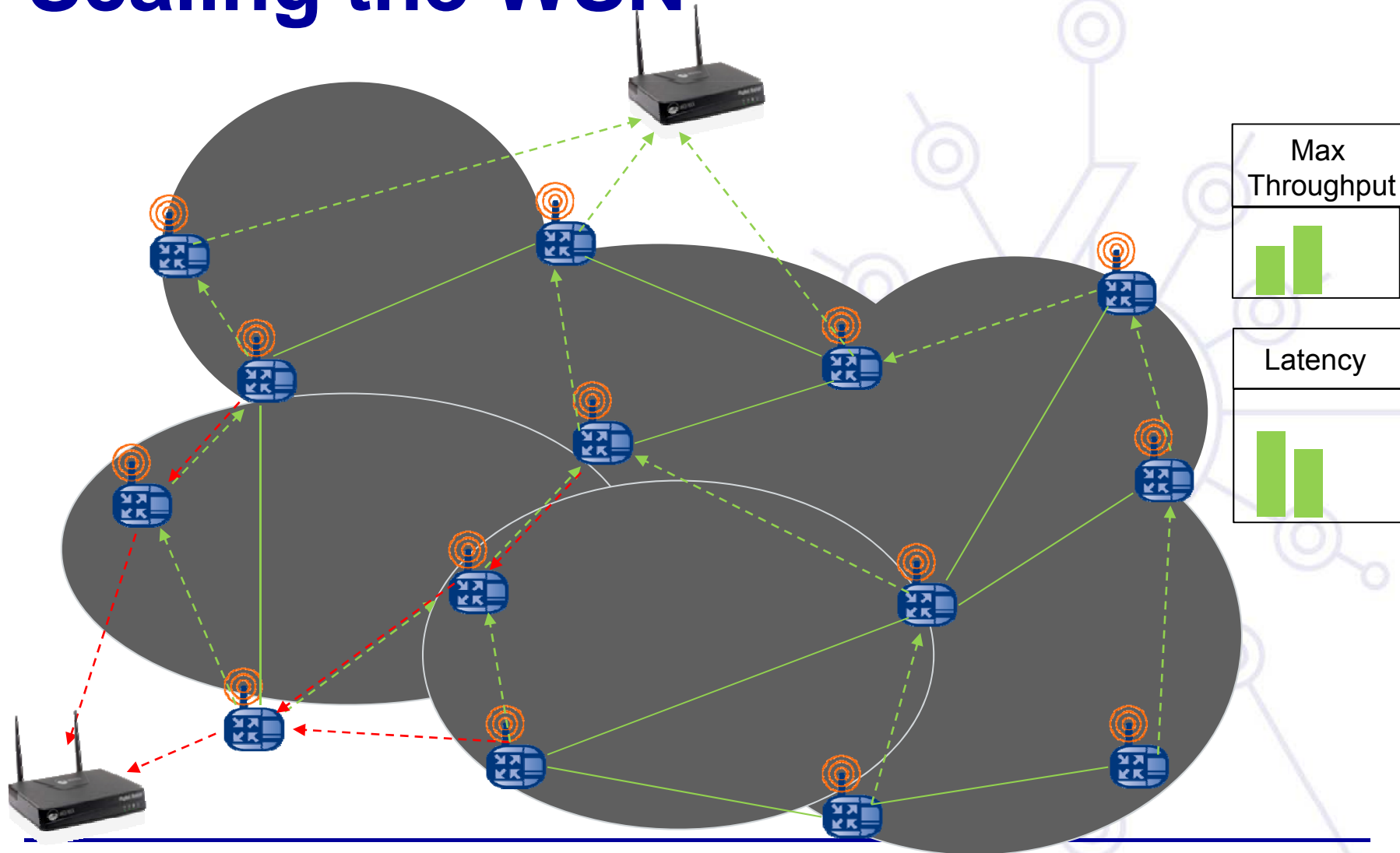

# Scaling the WSN

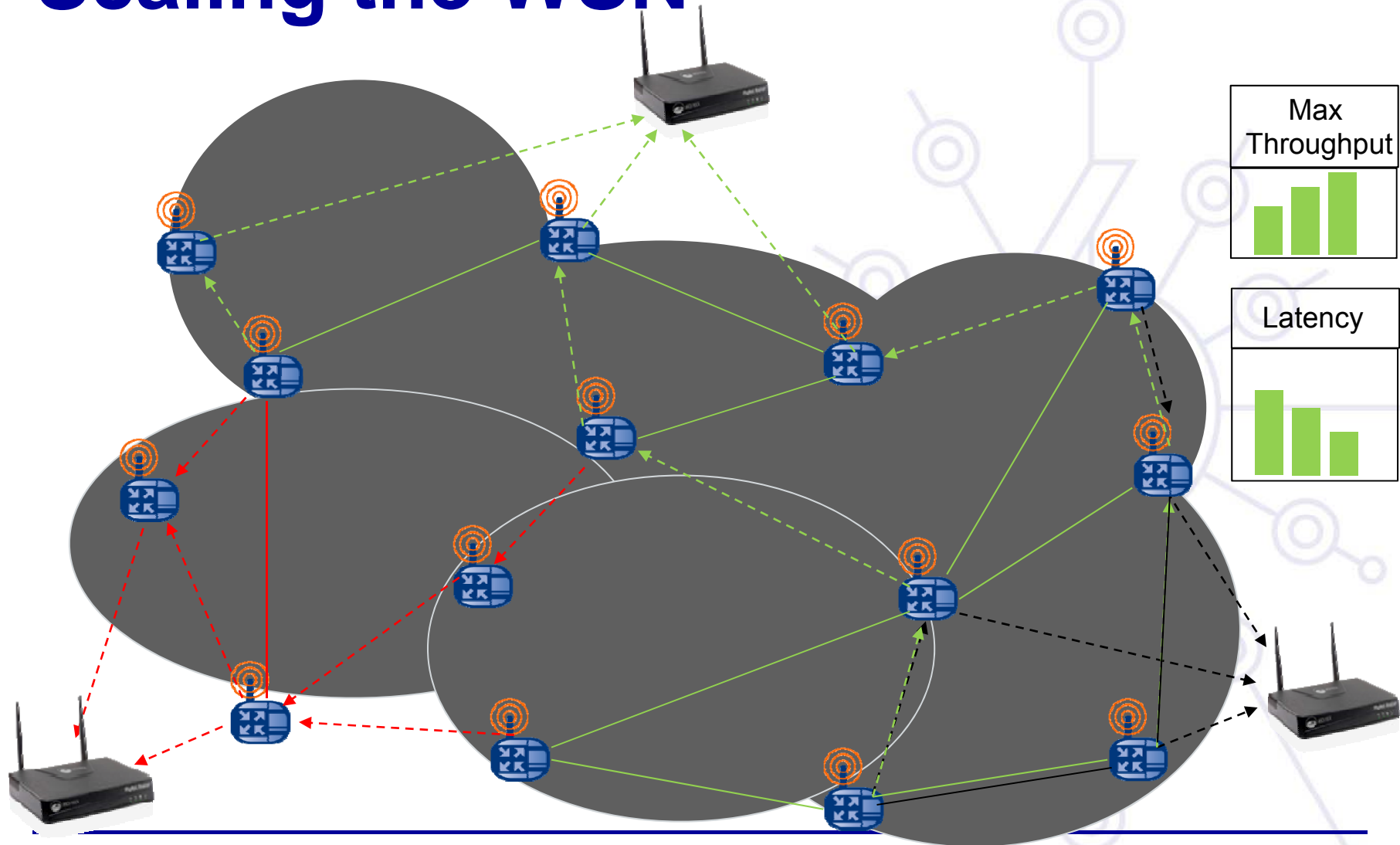

# Resiliency of the WSN

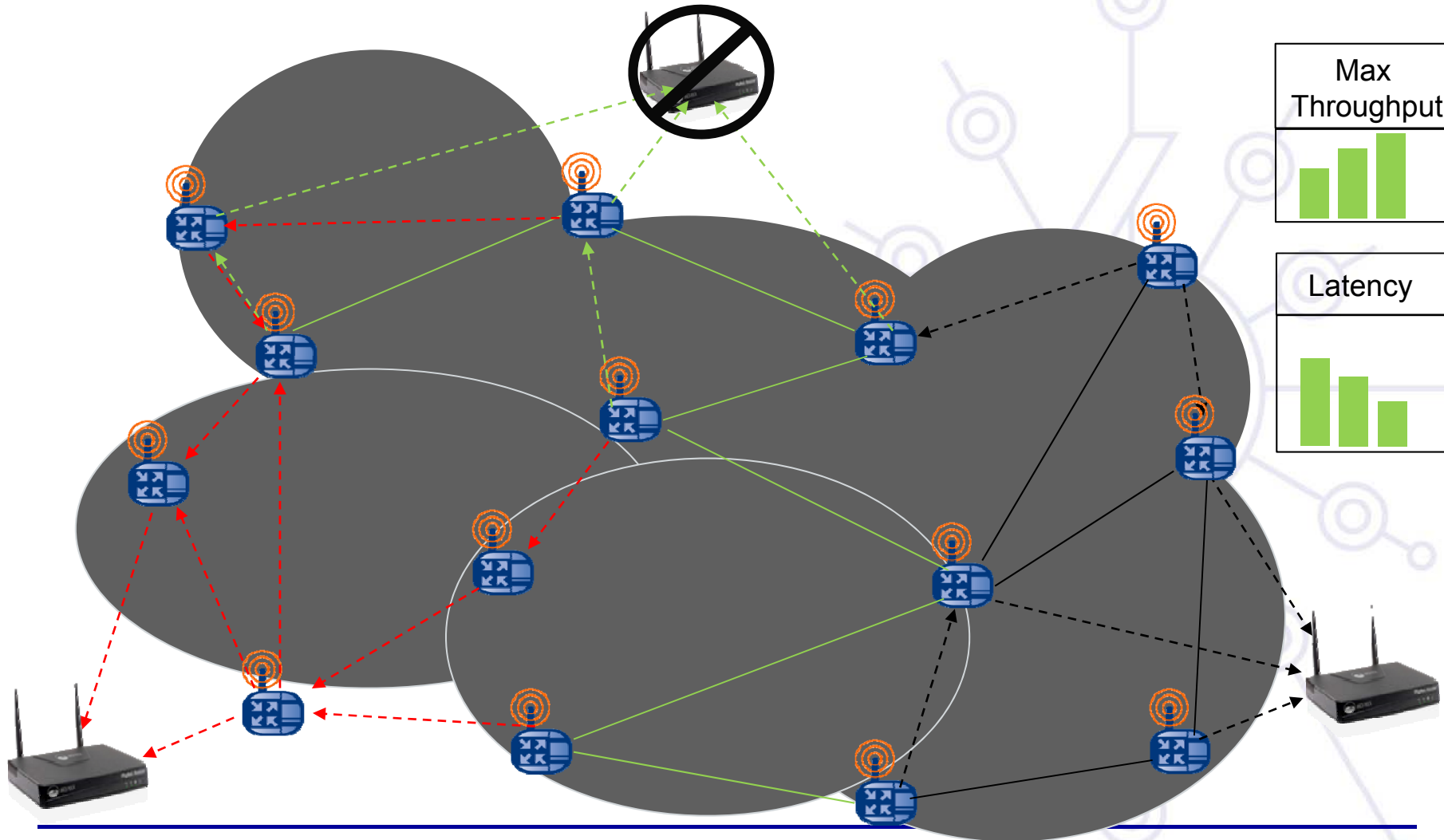

# Resiliency of the WSN

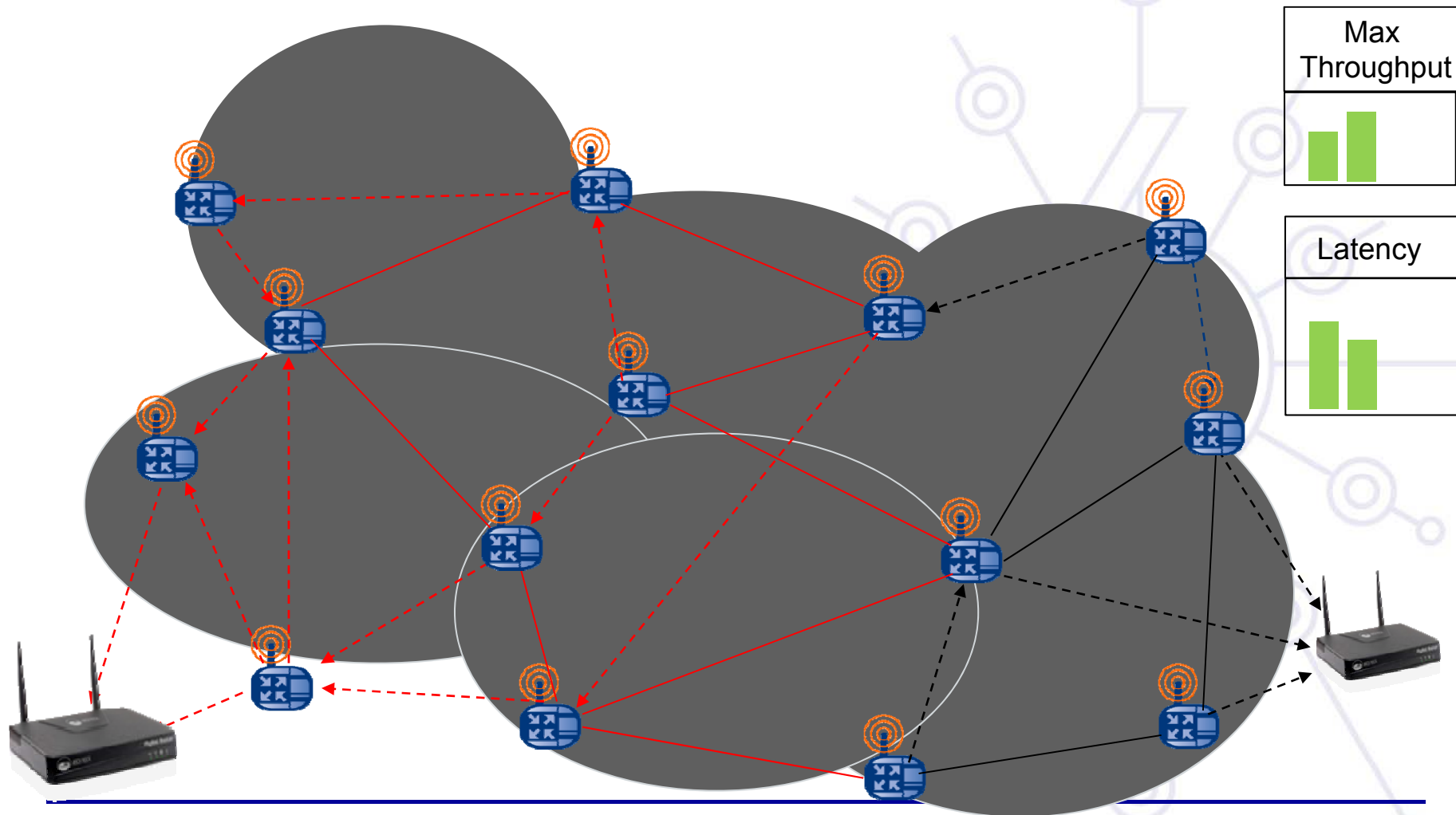

# Mobility in WSN

- Most WSN applications assume fixed networks, or limited mobility of nodes within the WSN
- Emerging mobility patterns (see RUNES/U-2010)
  - PANs for emergency responders (firemen with uniform-attached sensors, etc.)
  - Dynamically deployed nodes
- Network Mobility (NEMO) scenarios apply
- Mobile Ad-hoc Network Mobility (MANEMO) often more suitable
  - Avoid nested tunneling



# Compact Application Protocol

- ZigBee does not support IP
- To talk to IP devices it needs modification
- CAP: proposed to IETF and ZigBee Alliance
  - Modifies ZigBee protocol with UDP/IP adaptation layer
  - Can bridge diverse types of devices across large application domains:
    - Legacy industrial sensors, wireless/wired
    - 802.15.4 / LoWPAN
    - Emerging powerline communication networks

# Co-ordinated Adaptive Power (CAP) Management

- **For a wireless sensor node**
  - Wireless communication is the highest energy consuming unit and after that processing unit consumes significant amount of energy.
  - Management of energy consumption of these two units is important.
- **CAP management** is a technique to co-ordinate active operating states of processor and transmitter in a particular time slot adaptively with workload.
- **CAP management considers the following assumptions:**
  - A short haul multi-hop communication is preferred.
  - Each node acts as a router and simply forwards the received data to other nodes most of the time.
  - Total number of border nodes is much smaller than the total number of nodes in the field.
  - Percentage of data to be forwarded is much greater than the percentage of data actually sensed.
  - Predicted workload tracks the actual workload efficiently.

# Node Operating Systems

- Various compact operating systems developed for sensor nodes
  - Small memory size
  - Power saving facilities
  - Reduced IPv6 Stack
- Examples:
  - Contiki, <http://www.sics.se/contiki>
  - TinyOS, <http://www.tinyos.net>
- Common smart sensor node is MOTES

# TinyOS

- ❑ TinyOS is an open-source operating system designed for wireless embedded sensor networks.
- ❑ It features a component-based architecture which enables rapid innovation and implementation while minimizing code size.
- ❑ TinyOS's component library includes network protocols, distributed services, sensor drivers, and data acquisition tools.
- ❑ TinyOS's event-driven execution model
  - enables fine-grained power management
  - allows the scheduling flexibility made necessary by the unpredictable nature of wireless communication and physical world interfaces.
- ❑ TinyOS has been ported to over a dozen platforms and numerous sensor boards

# TinyOS

- ❑ A 6lowpan/IPv6 stack has been implemented for the TinyOS 2.0 operating system.
- ❑ It is possible to exchange IPv6 packets between the motes and a PC without an 802.15.4 interface. In case IP forwarding is set up on the PC and a properly assigned and routable global IPv6 prefix is used, the motes can be connected to the global Internet.
- ❑ The main limitation to interoperability with other 6lowpan implementations is the absence of a proper 802.15.4 stack in TinyOS 2.0. Although the implementation supports the ICMP echo mechanism and the UDP protocol, many features required for IPv6 implementations are missing.
- ❑ Among others, the Neighbor Discovery has not been implemented and packets are broadcasted on the link-layer, IPv6 extensions headers are not processed, IPv6 fragmentation is not supported and ICMP error messages are not generated.

# Contiki

- **Contiki** open source, highly portable, multi-tasking OS for networked memory-constrained networked embedded systems.
  - A typical Contiki configuration is 2 KB of RAM and 40 KB of ROM.
  - Contiki consists of an event-driven kernel on top of which application programs are dynamically loaded and unloaded at runtime.
  - Contiki contains two communication stacks: uIP and Rime.
    - uIP - a small RFC-compliant TCP/IP stack that makes it possible for Contiki to communicate over the Internet.
    - Rime - a lightweight communication stack aimed at low-power radios.
  - Contiki runs on a variety of platform ranging from embedded microcontrollers to old home computers. Code footprint is on the order of kilobytes and memory usage can be configured to be as low as tens of bytes.
  - Contiki is written in the C programming language.
-

# Agenda

- Introduction
- The Generic Components
- Standards and Technologies
- An Example – the Arch Rock Portfolio
- Deployment Case Studies
- Conclusion

# IP on Motes is a reality today

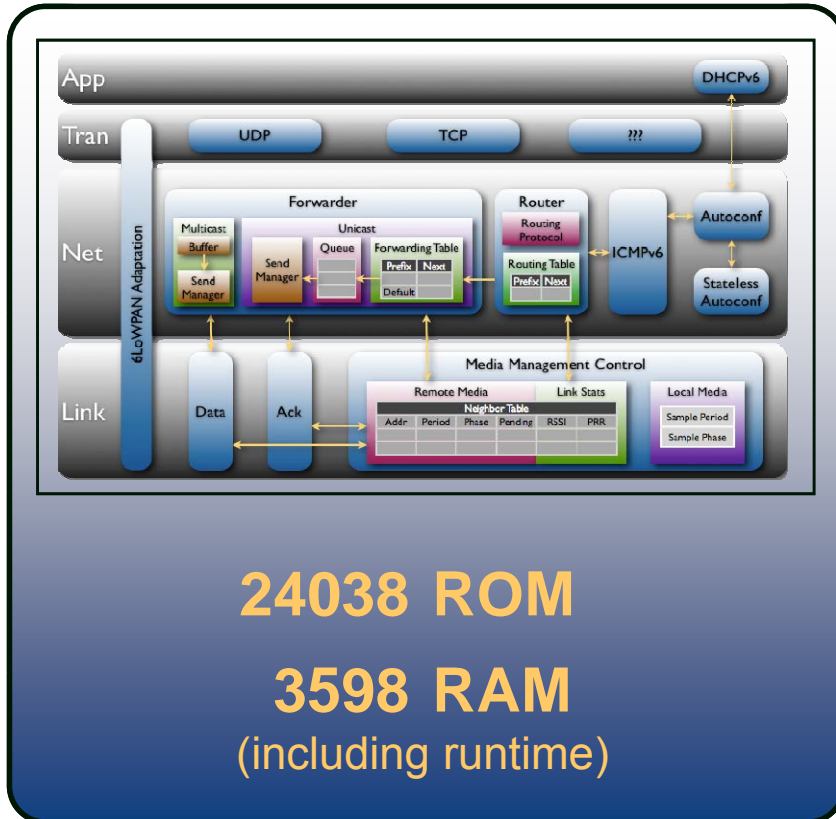

\* Production implementation on TI msp430/cc2420

## ■ Footprint, power, packet size, & bandwidth

	ROM	RAM
CC2420 Driver	3149	272
802.15.4 Encryption	1194	101
Media Access Control	330	9
Media Management Control	1348	20
6LoWPAN + IPv6	2550	0
Checksums	134	0
SLAAC	216	32
DHCPv6 Client	212	3
DHCPv6 Proxy	104	2
ICMPv6	522	0
Unicast Forwarder	1158	451
Multicast Forwarder	352	4
Message Buffers	0	2048
Router	2050	106
UDP	450	6
TCP	1674	50





# ArchRock PhyNet Architecture

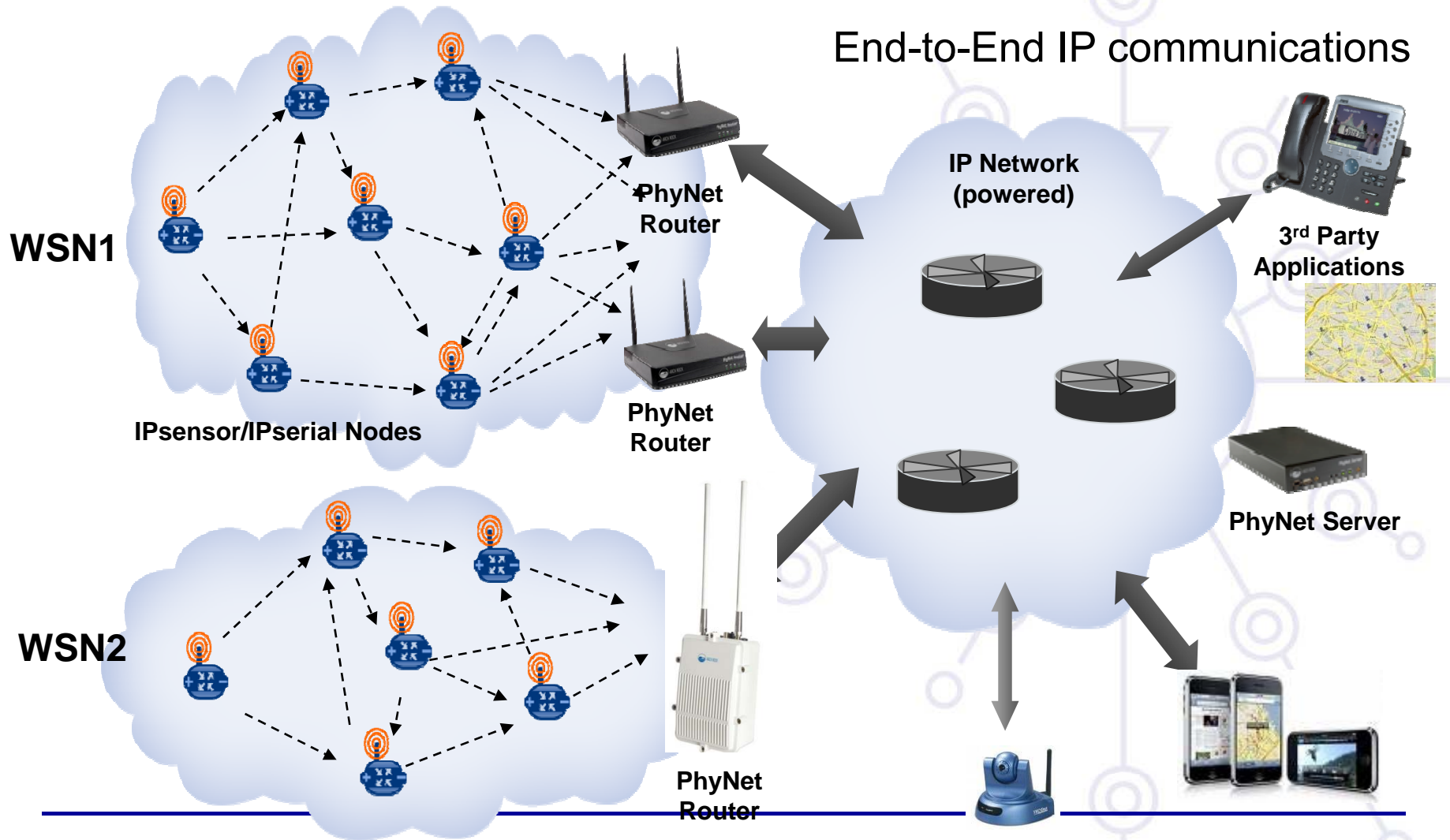



# PhyNet Architecture

## Benefits

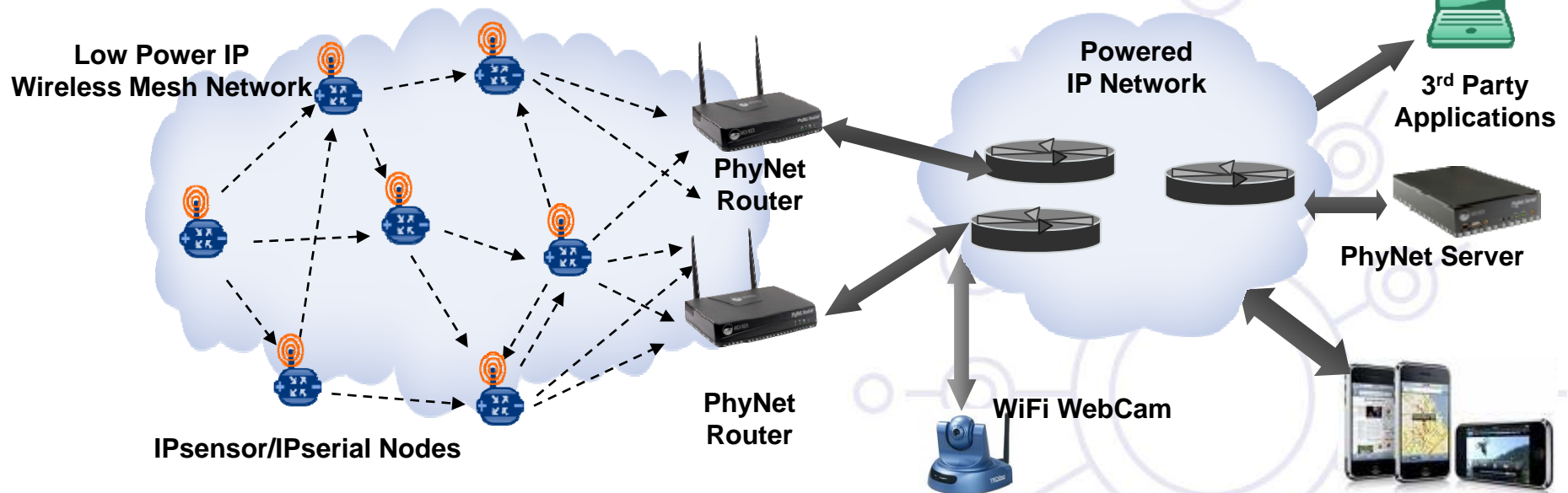

- **Embedded Mesh Network:** IPv6-based, sensing and routing with low power
  - *Open standard, auto-configuration, power autonomy, fast recovery, fast response, security*
- **Routed End-to-End IP:** Router-based edge layer extends Internet model
  - *Ease of deployment and management, enablement of mixed network device applications*
- **Multi-Tier Architecture:** Central services and distributed routing
  - *Enterprise scale, distributed deployment, centralized management and presentation*
- **Embedded Web Services:** XML/SOAP/REST-based presentation
  - *Openness to customer application development over standard enterprise API interfaces*

# ArchRock PhyNet Portfolio

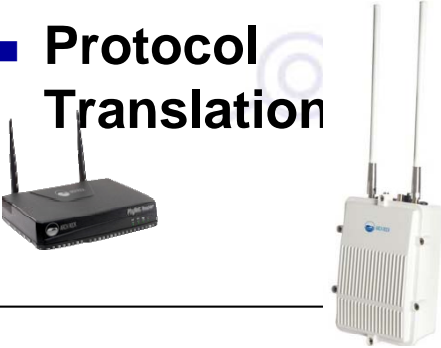
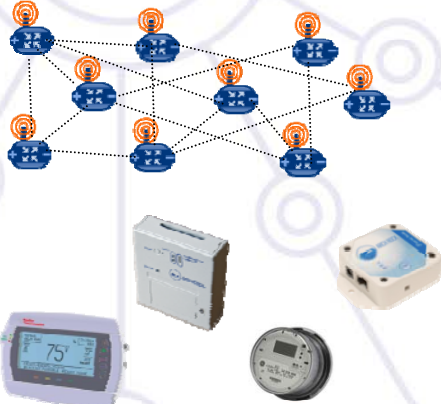
Server	Router	IP Nodes
<ul style="list-style-type: none"> <li>■ System Management Router Management</li> <li>■ Data Management, Visualization and Warehouse</li> </ul> 	<ul style="list-style-type: none"> <li>■ Indoor/Outdoor Network Management PAN/WAN/LAN</li> <li>■ Node Association</li> <li>■ Protocol Translation</li> </ul> 	<ul style="list-style-type: none"> <li>■ Mesh Routing</li> <li>■ Sensors and Actuators</li> <li>■ Embedded Web Services</li> </ul> 

# PhyNet Wireless Nodes

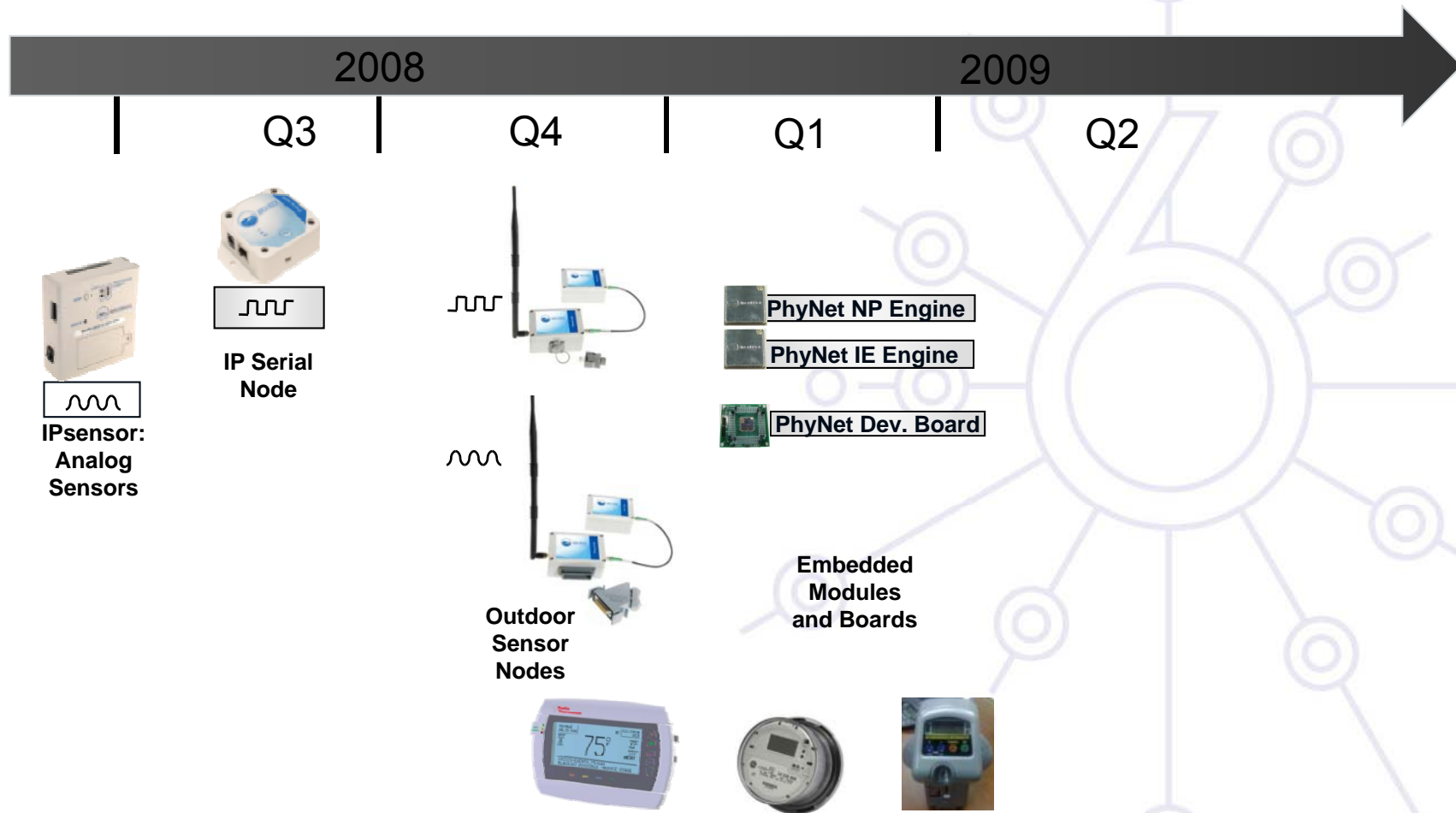

# Sensor node web page example

Wireless sensor node name

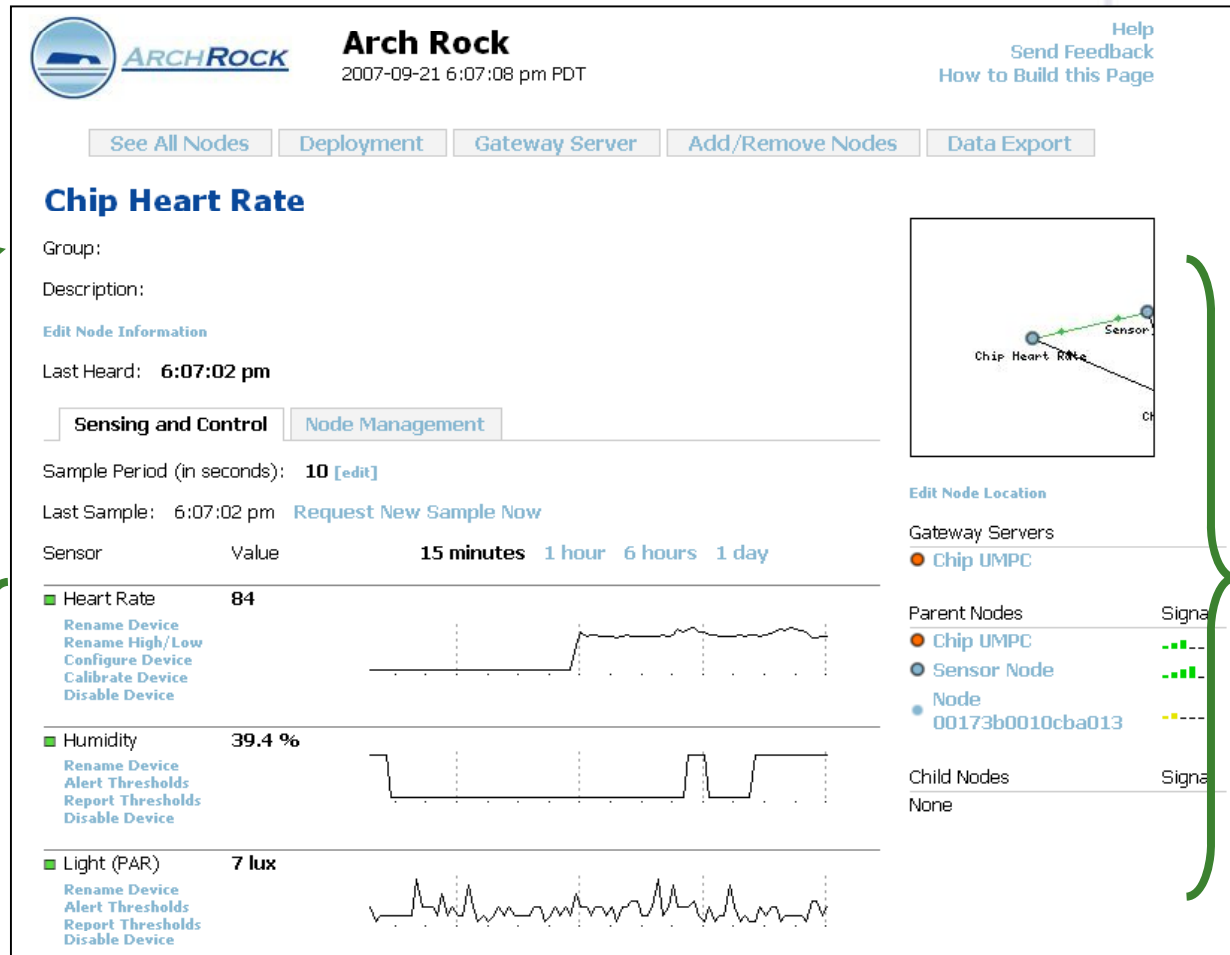

The screenshot shows a web interface for a sensor node named 'Chip Heart Rate'. At the top, it displays the 'ARCHROCK' logo and the node name 'Arch Rock' with a timestamp '2007-09-21 6:07:08 pm PDT'. Navigation buttons include 'See All Nodes', 'Deployment', 'Gateway Server', 'Add/Remove Nodes', and 'Data Export'. The main content area is titled 'Chip Heart Rate' and includes a 'Group:' field, a 'Description:' field, and an 'Edit Node Information' link. The 'Last Heard' time is '6:07:02 pm'. Below this, there are two tabs: 'Sensing and Control' (selected) and 'Node Management'. Under 'Sensing and Control', the 'Sample Period (in seconds)' is set to '10'. The 'Last Sample' is '6:07:02 pm' with a 'Request New Sample Now' link. A table lists sensor data:

Sensor	Value	15 minutes	1 hour	6 hours	1 day
Heart Rate	84	[Line graph showing heart rate history]			
Humidity	39.4 %	[Line graph showing humidity history]			
Light (PAR)	7 lux	[Line graph showing light history]			

Each sensor entry has links for 'Rename Device', 'Alert Thresholds', 'Report Thresholds', and 'Disable Device'. To the right, there is a map showing the node location and a legend for 'Gateway Servers' (Chip UMPC), 'Parent Nodes' (Chip UMPC, Sensor Node), and 'Child Nodes' (Node 00173b0010cba013). A 'Help' section with links for 'Send Feedback' and 'How to Build this Page' is also present.

Sensor data: Current value and history

Wireless network information

# PhyNet Wireless Sensor Node

## ■ Indoor and Outdoor Sensors

- ❑ Built-in temperature, humidity, light
- ❑ External sensor inputs – analog, digital



## ■ Networking

- ❑ IEEE 802.15.4 Radio
- ❑ Power-efficient Mesh networking
- ❑ Security
  - AES-128 link encryption
  - Node authentication
- ❑ IETF 6LoWPAN
  - Ping/Traceroute/TCP/UDP



# PhyNet IPserial Node

Easily connect to data loggers, smart digital sensors and legacy wired buses



RS232 / RS485  
interfaces

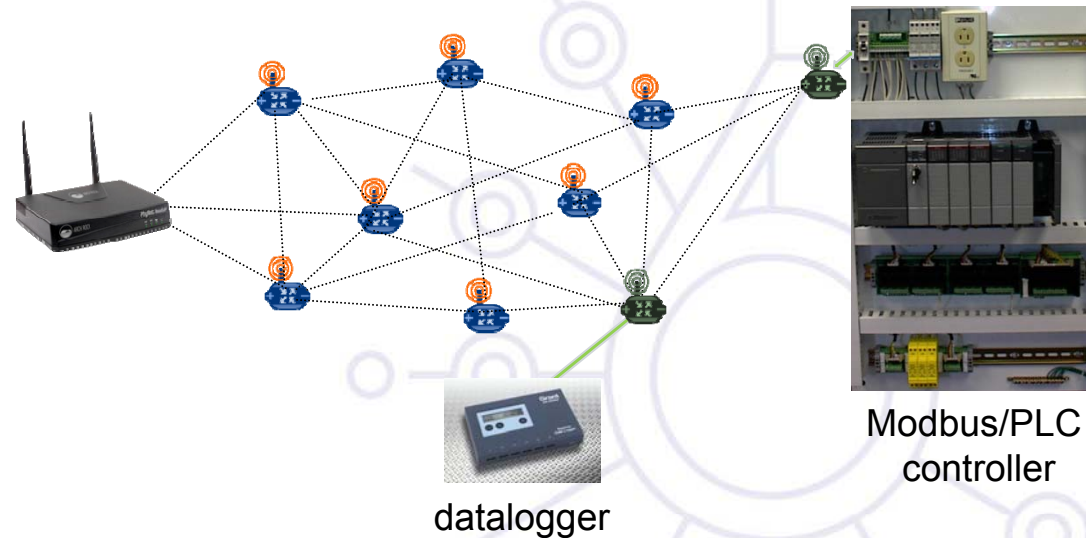

- Address a broad set of instruments and data loggers
- Bring sensing and control systems that use legacy wired buses (e.g., ModBus) equipped with serial interfaces into the mesh
- Communicate with a broad array of highly precise, small-footprint digital sensors
- All IPseries Nodes route and provide IP services (telnet, UDP, TCP, etc.)

# PhyNet Engine – OEM Offering

Turns customer device into an IP- and web-enabled, low-power wireless node

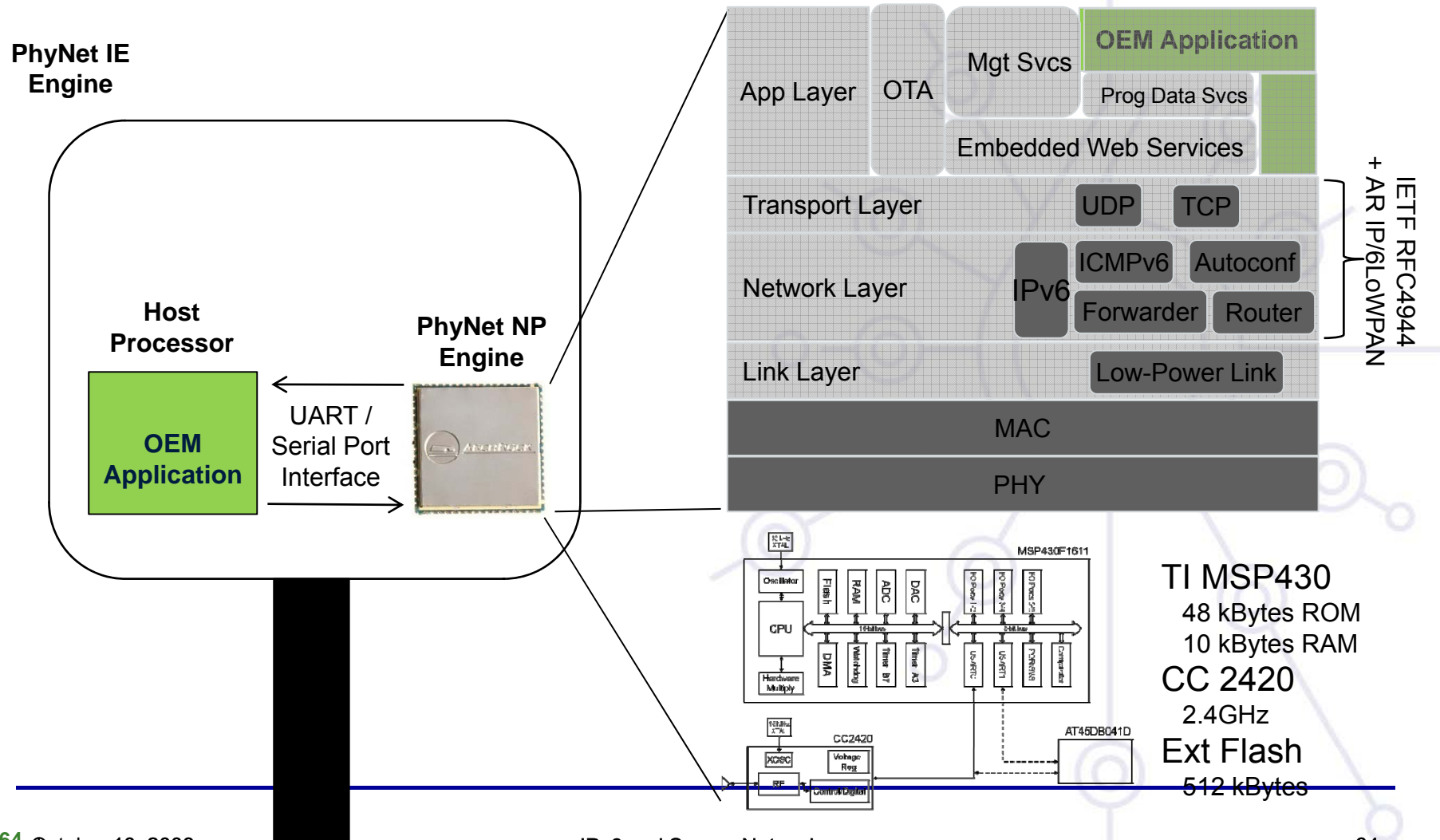

**TI MSP430**  
 48 kBytes ROM  
 10 kBytes RAM

**CC 2420**  
 2.4GHz

**Ext Flash**  
 512 kBytes



# PhyNet Router

## Features

- 802.15.4 WSN
- Ethernet/WiFi, GPRS uplinks
- Dynamic routing across multiple PNRs at edge of PAN offering nodes multiple egress points
- IPv4 to IPv6 routing and protocol translation

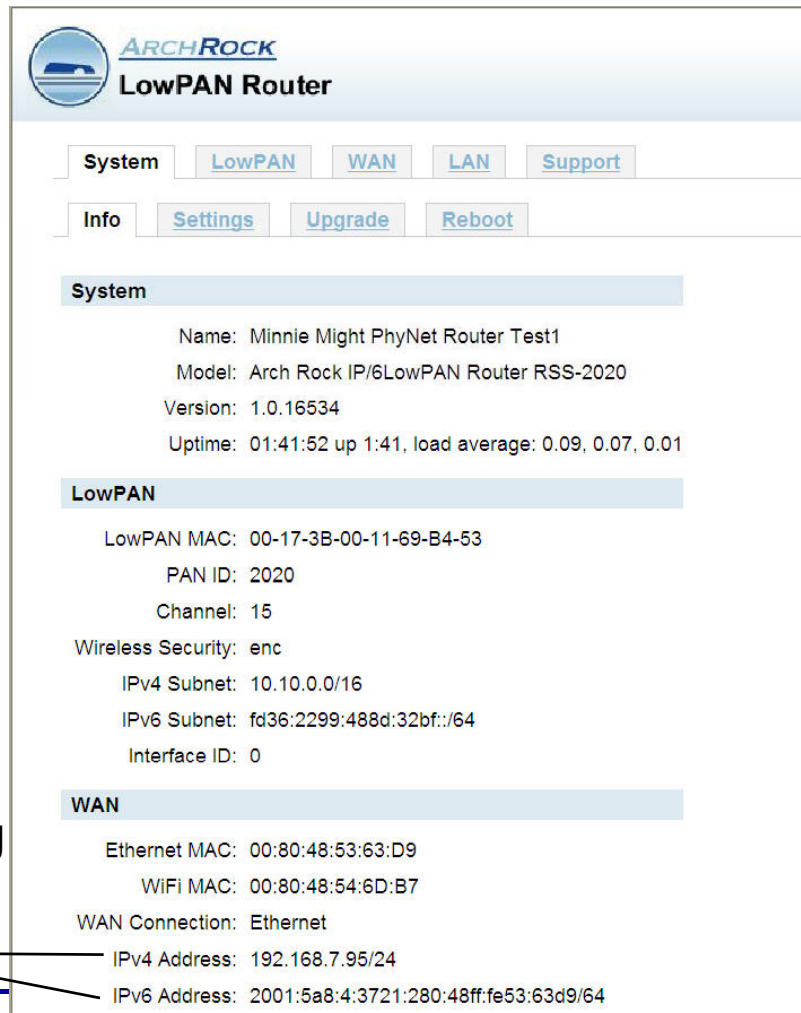

**ARCHROCK LowPAN Router**

System | LowPAN | WAN | LAN | Support

Info | Settings | Upgrade | Reboot

**System**

Name: Minnie Might PhyNet Router Test1  
 Model: Arch Rock IP/6LowPAN Router RSS-2020  
 Version: 1.0.16534  
 Uptime: 01:41:52 up 1:41, load average: 0.09, 0.07, 0.01

**LowPAN**

LowPAN MAC: 00-17-3B-00-11-69-B4-53  
 PAN ID: 2020  
 Channel: 15  
 Wireless Security: enc  
 IPv4 Subnet: 10.10.0.0/16  
 IPv6 Subnet: fd36:2299:488d:32bf::/64  
 Interface ID: 0

**WAN**

Ethernet MAC: 00:80:48:53:63:D9  
 WiFi MAC: 00:80:48:54:6D:B7  
 WAN Connection: Ethernet  
 IPv4 Address: 192.168.7.95/24  
 IPv6 Address: 2001:5a8:4:3721:280:48ff:fe53:63d9/64

## Benefits

- Eliminates need to co-locate server on-site with WSN
- Robustness
- Resiliency
- Higher throughput
- Lower latency
- Longer node battery life
- Supports IPv4 backhaul and enterprise networks

# PhyNet Routers

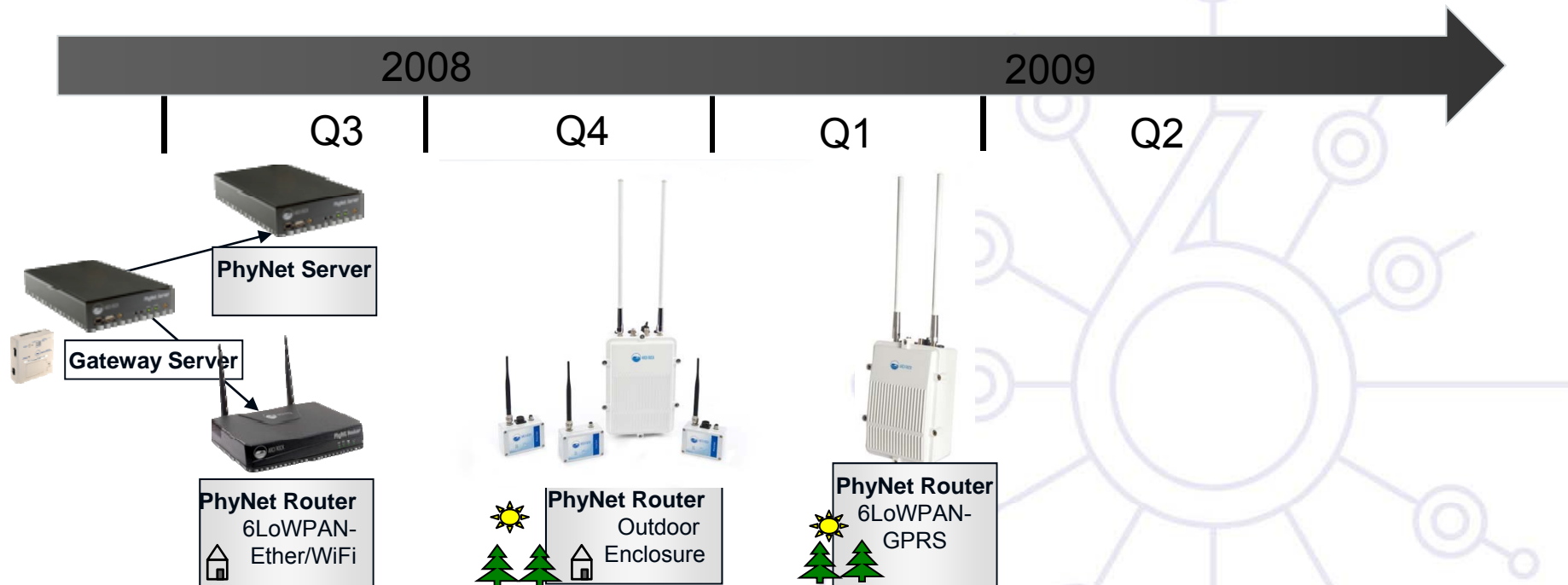

- IPv4 and IPv6
- 6LoWPAN
- Power over Ethernet

# PhyNet Server

End-to-end IP architecture and embedded web services provides an extensible out-of-the box management interface



Discover, register, move and configure nodes; enable and disable sensors

Display performance stats; set reporting intervals, thresholds and alerts.

Visualization and analysis of multiple sensor data streams



Home

**Setup**

- Server
- Border Routers
- Nodes
- Software Update

**System and Network**

- Connectivity
- Energy
- Traffic
- Reliability

**Sensing and Control**

- Sensor/Actuator Devices
- Sensor Data Analysis
- Actuator Control
- Data Export

**Support and Resources**

- User Documentation
- IP Network Administration
- Developer Resources

I wish this page would...

Send Feedback

© 2006-2008 Arch Rock Corporation. All Rights Reserved.

## Home (Gateway)

● Gateway Server ● Border Router ● Sensor Node

Deployment started on 2008-02-28 5:56:04 pm PST, running for 6d 18h 12m 6s.

### Deployment Map

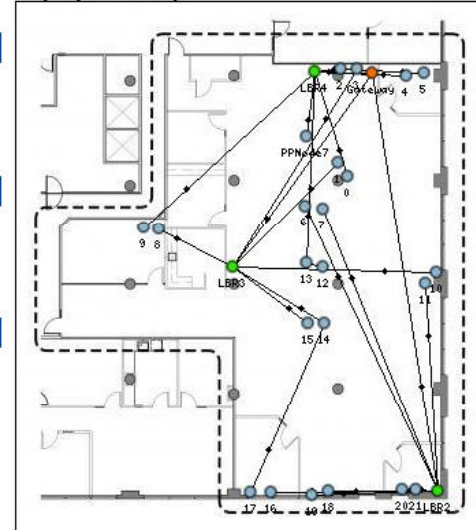

### Nodes

26 Registered Nodes

- **LBR2**  
12:05:53 pm
- **LBR3**  
12:05:53 pm
- **LBR4**  
12:05:53 pm
- **PPNode7**  
12:07:37 pm  
73.1 °F 37.8 % 95 lux 15 lux
- **Slug 0**  
● **0**  
12:03:33 pm  
84.3 °F 27.8 % 344 lux 44 lux
- **1**  
12:04:01 pm  
85 °F 26.6 % 98 lux 15 lux
- **2**  
12:04:57 pm  
83.4 °F 27.8 % 406 lux 32 lux
- **3**  
12:05:48 pm  
84.5 °F 28.1 % 69 lux 10 lux

Redundant Access Routers

Summary sensor data

# Agenda

- Introduction
- The Generic Components
- Standards and Technologies
- An Example – the Arch Rock Portfolio
- Deployment Case Studies
- Conclusion

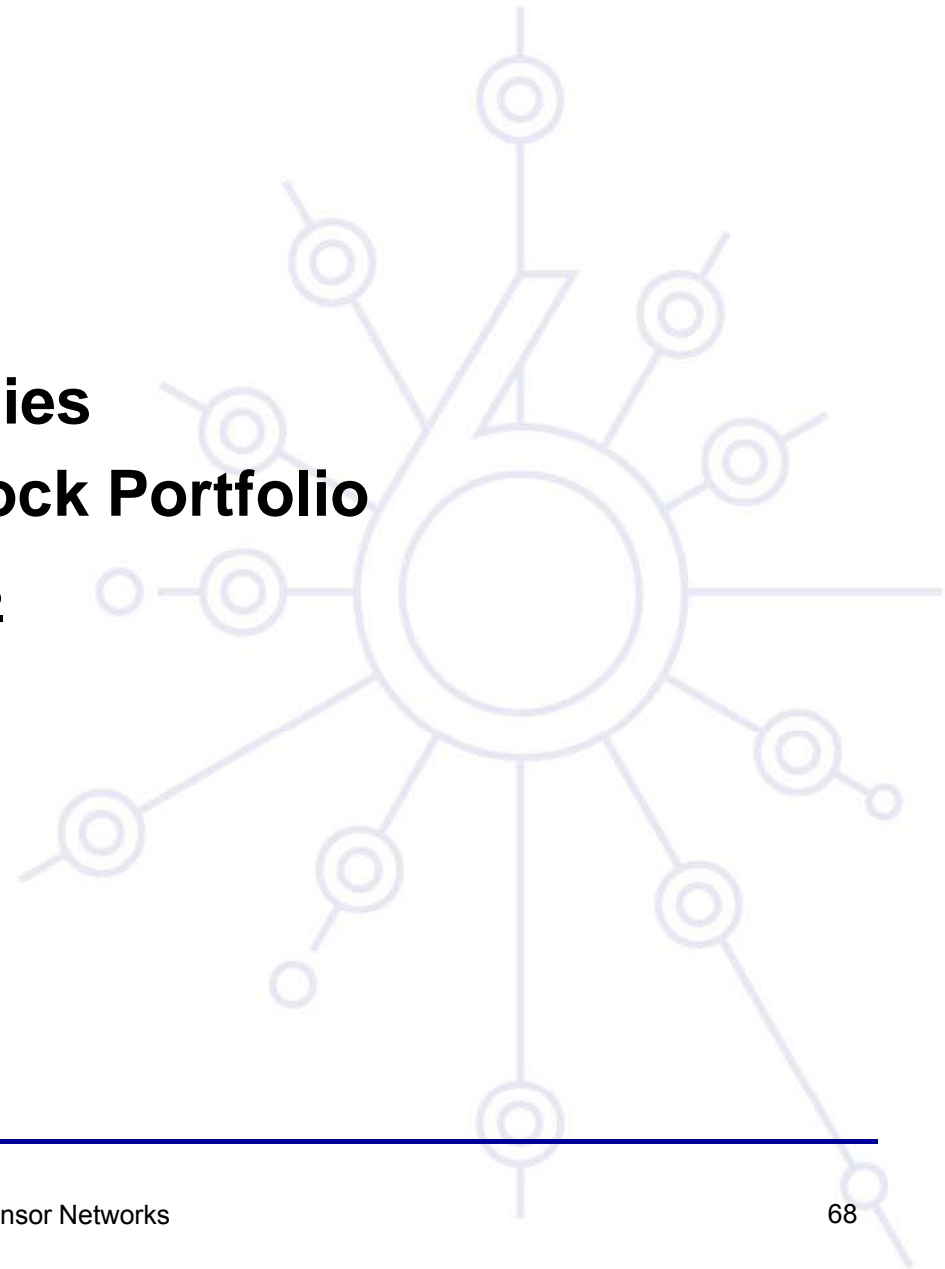

# Collaborative WSN Communities

- **Web 2.0 – Collaboration – Cloud Computing**
  - Education
  - Research
  - Interest Groups
  - Public Information
- **End to End IP architecture to directly get data from sensor nodes**
  - **Let's get your imagination developing the usage!**

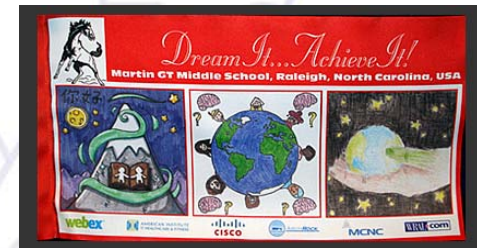

# PhyNet in Wireless Cities

- **City environment, biology, air quality**
  - Alarms, surveillance, treaty verification
- **Disaster situational tracking and sensing**
  - Infrastructure health monitoring
- **Metering**
  - Parking meters
  - Street lights
- **Solutions**
  - Outdoor PhyNet router(s) connected to Public WLAN or GPRS Infrastructure
  - Outdoor PhyNet or embedded nodes



# PhyNet in Green Buildings

- Commercial Building Infrastructure health monitoring
- Indoors or outdoors environmental data
- Energy savings
- Air quality
- Building comfort, energy efficiency
  - Alarms, surveillance, treaty verification
- Monitoring Condition-based machine maintenance
- Advanced metering, resource usage
  - Sub-metering (up to desk level)
  - Lighting control



# Anatomy of a Landfill



Methane well and  
gas collection pipes

Leachate fluid  
collection pipes



Storm water  
drain pipes

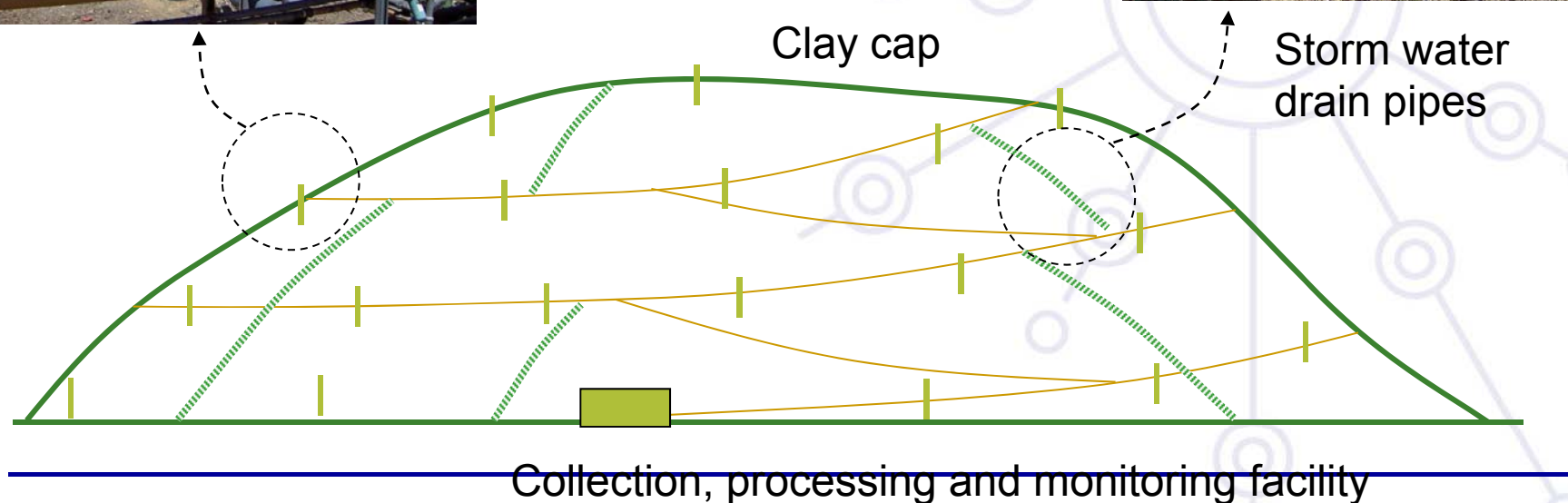



# PhyNet Green Building Deployment

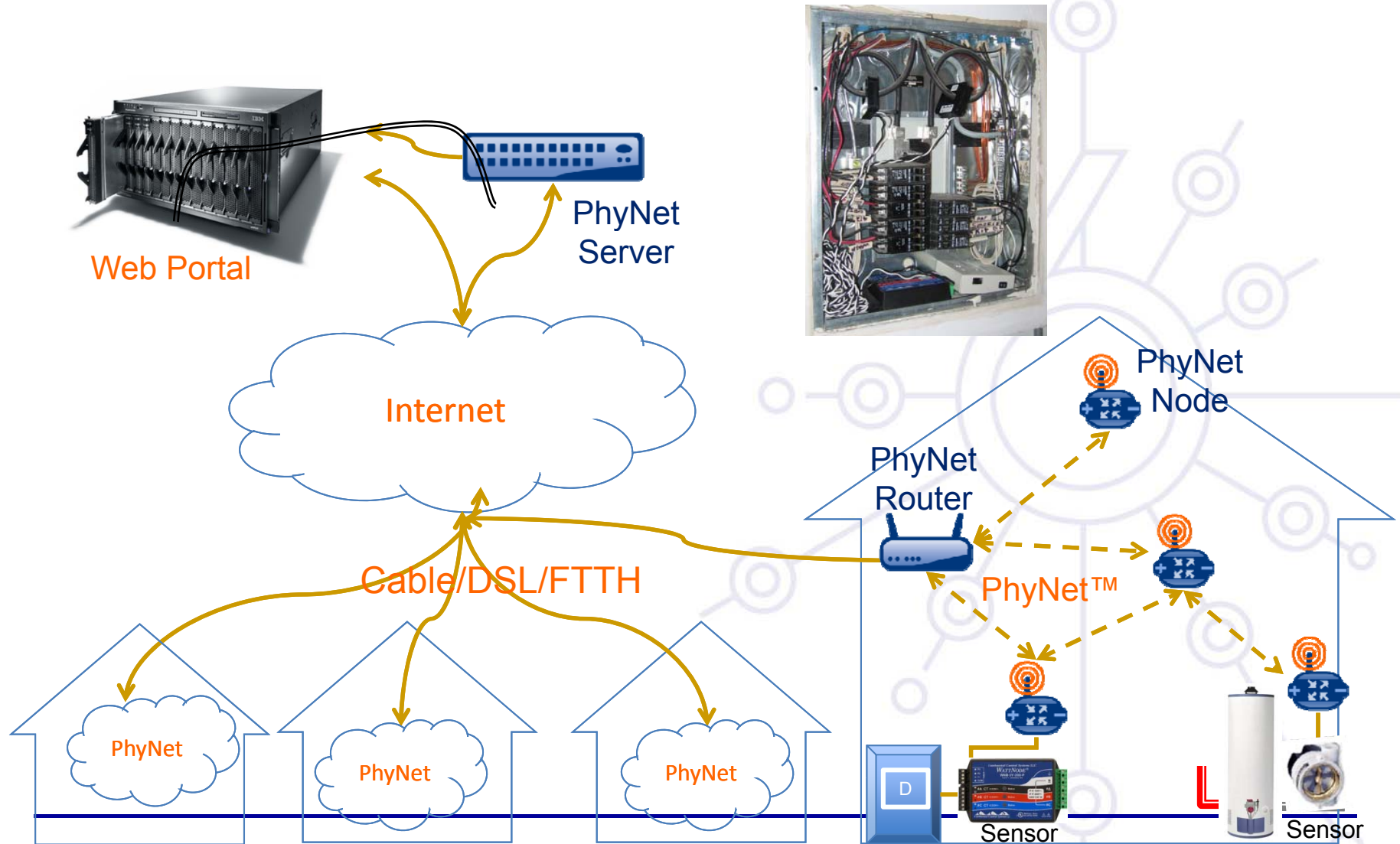

# PhyNet in the Data Center

- **Continuous Visibility**
  - Temperature, humidity and Air flow profiles
  - Power -- Which device/rack is using exactly how much
- **Analysis/Data export**
  - Alerts and notifications based on thresholds
  - Complete fine-grain data for detailed historical analysis
- **Action**
  - Manual tuning of HVAC system
  - Closed loop automatic control as warranted
  - Virtualization and load migration
    - Concentrate compute loads and cooling for better efficiency
    - Spread compute load to optimize cooling resources
    - Time and demand based load migration -- end of the month, qtr, year
  - Long term planning from better data

Benefits

- **Energy savings**
  - More efficient cooling (reduced HVAC costs)
  - Reduction of power used by servers
    - by dynamic redistribution of the compute load
- **Conformance**
  - “Name-plate” vs actual power usage
- **Lower capital expenditure**
  - Less “over-provisioning”



and  
compute

# PhyNet for Server Room Thermal Auditing/Monitoring

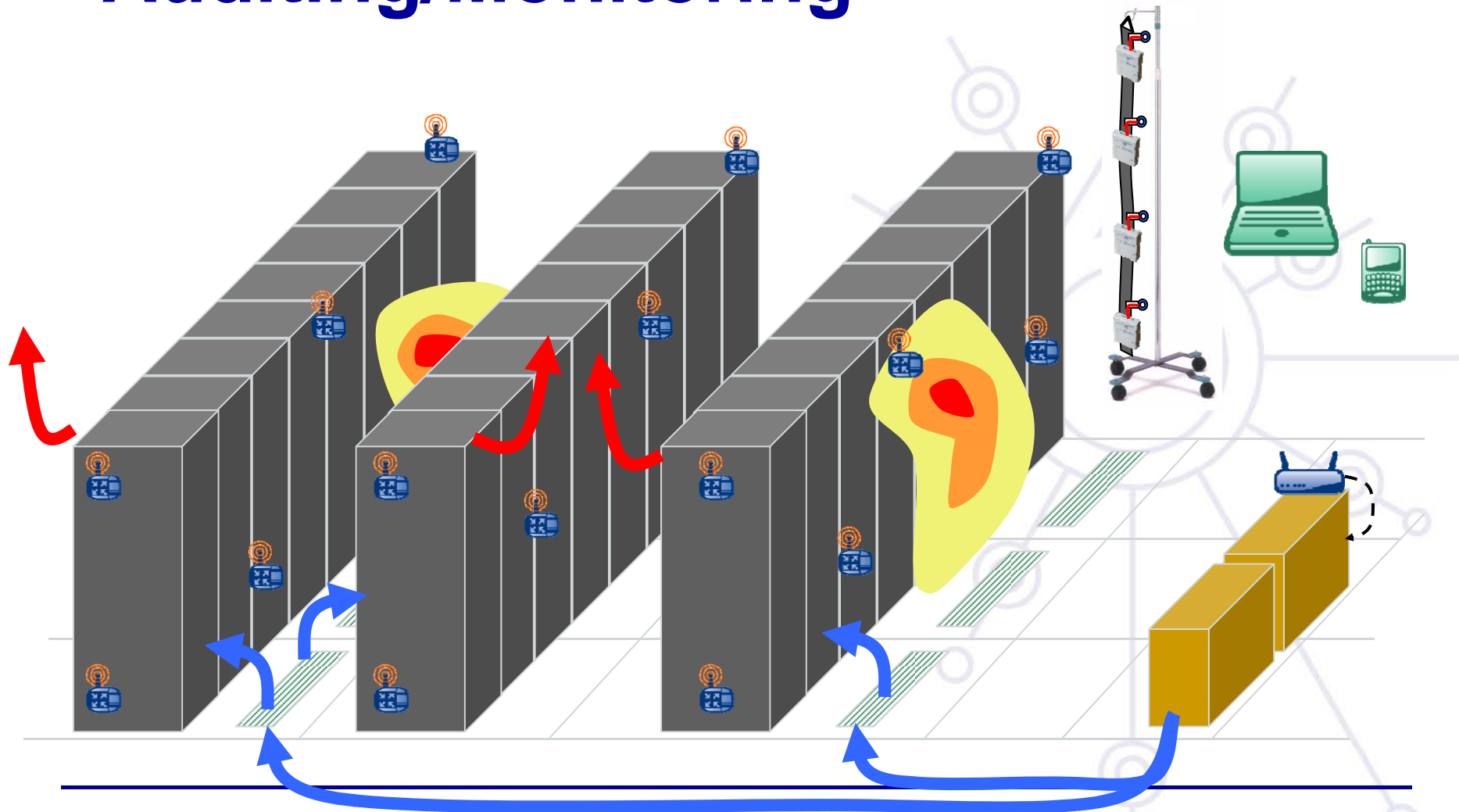



# PhyNet in Refrigeration Monitoring

Problem Open loop employee monitoring of in-store refrigeration susceptible to spoilage for high-value food items

ArchRock Solution Closed-loop M2M monitoring with sensor network which scales to multiple locations



Store 1



- AR IPsensor nodes
- Temperature
  - Humidity
  - Mesh Routing
  - Embedded Web Services



Store 2



- PhyNet Router
- Dynamic Routing
  - Ethernet/WiFi uplinks



- PhyNet Server
- Located offsite
  - Remote Monitoring & Management for single location or entire chain
  - Threshold alerts protect High Value Food Items
  - Defrost cycle trend analysis

# Outdoor Environmental Monitoring

- Natural environment, biology, air quality
- Resources preservation
- Water,...
- Disaster situational tracking and sensing
- Infrastructure health monitoring
- Advanced metering, resource usage

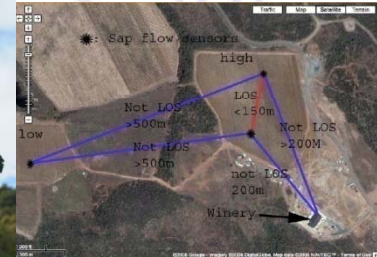

# The Wireless Landfill

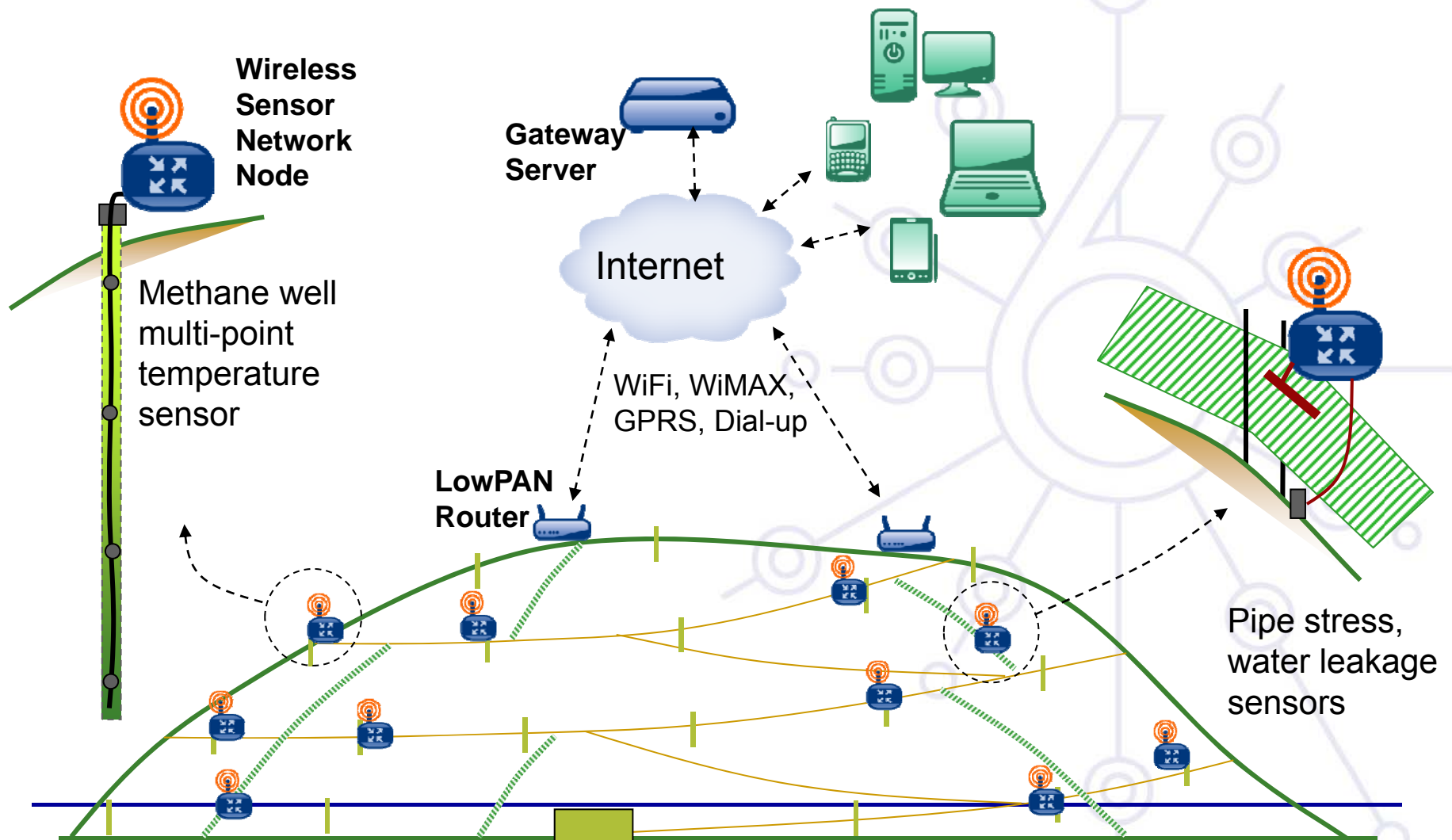

# Continuous Visibility and Alerting

- Gas wells
  - Under-the-cap temperature, at various depths
  - Methane concentrations and flow characteristics
- Pipe stress, deformation and breakage
  - Fluid detection
  - Bending
  - Stress
- Leachate fluid composition and production
  - pH
  - Flow rate



## Sensor Data Analysis

Enable Sensor Devices  
Request Sample from All Enabled Sensors on All Nodes

List View Map View Chart View

Select a Sensor: All Sensors Refresh Data Auto-refresh every 60 seconds.

Name	Last Data	External	Temperature	Humidity	Light (PAR)	Light (TSR)
● IV-5DR	4:26:42 pm	Depth = 030 ft: 132.5 F Depth = 055 ft: 118.2 F Depth = 080 ft: 114.4 F Depth = 105 ft: 104.8 F	98.5 °F	40.2 %	10 lux	83 lux
● S-87	4:28:20 pm	Depth = 030 ft: 134.52 F Depth = 055 ft: 136.72 F Depth = 080 ft: 138.93 F Depth = 120 ft: 149.54 F	92.9 °F	34.1 %	10 lux	28 lux
● Strain Sensor	4:31:58 pm	ADCD: 257 ADCL: 597	92.6 °F	45.3 %	0 lux	25 lux
● TopDeck	4:30:57 pm	ADCD: 707 ADCL: 488	91.9 °F	43.1 %	10 lux	26 lux

# Conclusion

- Sensor devices everywhere
  - Wireless Sensor Networks will be everywhere
- Desirable to have them run IP
  - Internet of things...
- IPv6 can help with sheer volume of addressing required
  - Open standard
  - Interoperable with existing IP infrastructure
  - Interoperability with existing non-IP WSNs
- Security important