



Ruijie Networks – Innovation Beyond Networks

Ruijie RG-WLAN Implementation Cookbook (V4.0)



Copyright Statement

Ruijie Networks©2013

Ruijie Networks reserves all copyrights of this document. Any reproduction, excerpt, backup, modification, transmission, translation or commercial use of this document or any portion of this document, in any form or by any means, without the prior written consent of Ruijie Networks is prohibited.

 ,  ,  ,  ,  ,
 , **RGOS**[®] , **RGNOS**[®] ,  , **Red-Giant**[®] ,
Red-Giant 锐捷[®] , **锐捷**[®] are registered trademarks of Ruijie Networks. Counterfeit is strictly prohibited.

Exemption Statement

This document is provided “as is”. The contents of this document are subject to change without any notice. Please obtain the latest information through the Ruijie Networks website. Ruijie Networks endeavors to ensure content accuracy and will not shoulder any responsibility for losses and damages caused due to content omissions, inaccuracies or errors.

1 Preface

Audience

- Network Engineers
- Network Administrator

Obtain Technical Assistance

- Ruijie Networks Websites: <http://www.ruijienetworks.com>
- Ruijie Service Portal: <http://caseportal.ruijienetworks.com>

Welcome to report error and give advice in any Ruijie manual to Ruijie Service Portal

Revision History

Date	Change contents	Reviser
2015.10	Initial publication V1.0	Ruijie GTAC
2016.07	Publication V3.0	Ruijie GTAC
2016.11	Revise some commands and add new scenarios Based on RGOS 11.(5)B8	Ruijie GTAC
2017.02	Publication V3.2 with word.	Ruijie GTAC
2017.10	Add new chapter of 7.3 Import license to	Ruijie GTAC
2017.11	Fixed configuration guide of 4.4.5 Countermeasure against Rogue AP	Ruijie GTAC

2018.7	New version 4.0 release Adjust the overall structure of the cookbook and add some new features like: VAC, PPSK, Bonjour Gateway, Smart AP.	Ruijie GTAC
--------	---	-------------

2 Contents

1	Preface	1-1
2	Contents	2-3
3	Device Management	3-7
3.1	System Management.....	3-7
3.1.1	Console Management.....	3-7
3.1.2	Telnet Management	3-9
3.1.3	SSH Management.....	3-11
3.1.4	Web Management.....	3-14
3.1.5	Forget IP Address of Wall AP	3-15
3.2	Firmware Upgrade.....	3-16
3.2.1	Upgrade for RGOS 11.x	3-16
3.2.2	Upgrade from RGOS 10.x to 11.x.....	3-22
3.2.3	Downgrade from RGOS 11.x to 10.x.....	3-28
3.2.4	Recover Firmware under BOOT	3-34
3.3	Password Recovery.....	3-37
3.3.1	Recover AC & Fat AP password.....	3-37
3.4	Restore Factory Default	3-40
3.4.1	Restoring AC & FAT AP.....	3-40
3.4.2	Restoring FIT AP.....	3-41
3.4.3	Restoring WALL AP	3-41
3.5	Backup Configuration	3-41
3.5.1	Backup to Flash	3-41
3.5.2	Backup to TFTP Server	3-45
3.6	License Application.....	3-46
3.7	FAQ	3-51
3.7.1	what traffic is need to be allowed to pass the firewall between the AC and the RADIUS server?	3-51
3.7.2	How to kick a user offline	3-52
3.7.3	Where is the ap-config file saved on the AC?	3-52
3.7.4	Does the wireless network support VLAN-Group?	3-52
3.7.5	How to view the wireless terminal type and operating system information on the AC?... 3-52	
3.7.6	Which of “ap-conf all” and “ap-config name” takes effect first?	3-53
3.7.7	How to fix when the device cannot ping the domain name?	3-53
3.7.8	How to delete an offline AP?.....	3-53
3.7.9	How to configure the location of a fit AP?.....	3-53
3.7.10	How to modify the address used by the AC to create the CAPWAP tunnel?	3-54
3.7.11	How to modify the SSID of the wireless network?.....	3-54
3.7.12	How to configure the static AP IP address in fit AP mode?	3-54

3.7.13	How to disable a radio of the AP?	3-54
3.7.14	How to disable automatic adjustment for the RRM channel?	3-55
3.7.15	How to cancel AAA authentication for AC logon when AAA authentication is enabled on the AC? 3-55	
3.7.16	How to configure switchover of the AC/AP O/E multiplexing interface	3-55
3.7.17	How to synchronize the AC time to the AP.....	3-55
3.7.18	How to configure daily timed restart for the AP?	3-56
3.7.19	How to close the LED indicator of the AP?.....	3-56
3.7.20	How to check the number of APs that can be supported by a device?.....	3-56
3.7.21	How to view the MAC address of the AC?	3-57
3.7.22	How to fix when the AP management address is forgotten?	3-57
3.7.23	How to fix when the system can output information but cannot be operated during CRT-based logon through the Console port?.....	3-59
3.7.24	How many APs can different AC Model manage?	3-60
3.7.25	How to view the number of licenses occupied by different AP model on AC?	3-61
3.7.26	How to migrate a wireless AC license to another device (unbinding license).....	3-61
3.7.27	Can multiple temporary licenses be imported to the same device?.....	3-61
3.7.28	How to bind a license on VAC	3-62
3.7.29	Will APs go offline immediately if the license is unblind from AC?.....	3-62
3.7.30	Will online Aps be kicked offline when the licenses are insufficient after temporary authorization expires?.....	3-62
4	Basic Features	4-63
4.1	Fit AP Configuration	4-63
4.1.1	CAPWAP.....	4-63
4.1.2	Basic Configuration.....	4-68
4.1.3	AC Directly Connect to AP.....	4-75
4.1.4	Wall AP Front Port VLAN Assignment.....	4-78
4.1.5	CAPWAP tunnel is established via NAT.....	4-82
4.1.6	FAQ.....	4-87
4.2	Fat AP Configuration	4-99
4.2.1	FAT AP (General)	4-99
4.2.2	FAT AP (for wall AP).....	4-103
4.3	Rate Limit.....	4-110
4.3.1	Fit AP.....	4-110
4.3.2	Fat AP	4-112
4.3.3	FAQ.....	4-113
4.4	Wireless Security.....	4-116
4.4.1	Wireless Encryption (WPA/WPA2)	4-116
4.4.2	Blacklist&Whitelist.....	4-118
4.4.3	Association Control	4-123
4.4.4	DHCP Snooping + ARP-Check.....	4-127

4.4.5	Countermeasure against Rogue AP	4-130
4.4.6	User Isolation	4-134
4.4.7	Conceal SSID (Disable SSID Broadcast)	4-137
4.4.8	FAQ	4-138
4.5	WLAN Roaming.....	4-141
4.5.2	Layer-2 Inter-AC Roaming Configuration	4-141
5	Advanced Features	5-145
5.1	Band Select	5-145
5.1.1	Understanding Band Select	5-145
5.1.2	Configuring Band Select	5-147
5.1.3	FAQ	5-149
5.2	AC Virtualization (VAC)	5-150
5.2.1	Implementation Preparation.....	5-150
5.2.2	Fast Implementation	5-152
5.2.3	Fast Implementation in VSU Scenarios	5-156
5.2.4	Capacity Expansion Implementation	5-161
5.2.5	Service Deployment.....	5-163
5.2.6	Key Configuration Check	5-169
5.2.7	FAQ	5-170
5.2.8	Common Fault Locating.....	5-171
5.3	AC Hot-Backup.....	5-172
5.3.1	Understanding AC Hot-Backup.....	5-172
5.3.2	Configuring AC Hot-Backup.....	5-175
5.4	AC-Cluster	5-181
5.4.1	Understanding AC Cluster	5-181
5.4.2	Configuring AC Cluster	5-182
5.5	Time Schedule.....	5-183
5.5.1	Turn off LED in Fixed Time	5-183
5.5.2	Turn off Radio in Fixed Time.....	5-185
5.6	Wireless Multicast.....	5-188
5.6.1	FAQ	5-190
5.7	Local Forwarding.....	5-191
5.8	Wireless Authentication	5-193
5.8.1	802.1X Authentication	5-193
5.8.2	MAC Authentication Bypass (MAB)	5-202
5.9	Web Authentication	5-209
5.9.1	Understanding Web Authentication	5-209
5.9.2	Built-in Web Portal & Local Authentication	5-215
5.9.3	Built-in Web Portal & Radius Authentication	5-219
5.9.4	Ruijie Web Authentication V2 & Radius Authentication	5-222
5.9.5	Ruijie Web Portal Customization	5-226

5.9.6	FAQ.....	5-233
5.10	WDS	5-241
5.10.1	FIT AP	5-241
5.10.2	FAT AP	5-247
5.10.3	FAQ	5-254
5.11	Load Balance.....	5-256
5.11.1	FAQ	5-258
5.12	RIPT.....	5-260
5.13	NAT.....	5-262
5.14	URL Audit	5-263
5.15	PPSK	5-265
5.15.1	Overview	5-265
5.15.2	Scenario	5-265
5.15.3	Implementation Steps	5-265
5.15.4	PPSK Configuration and Verification Under the Command Line	5-269
5.15.5	PPSK Verification.....	5-270
5.16	Bonjour Gateway	5-275
5.16.1	Overview	5-275
5.16.2	Applications.....	5-275
5.16.3	Features	5-277
5.16.4	Configuration.....	5-278
5.16.5	Monitoring	5-284
5.17	Hierachical AC.....	5-286
5.17.1	Overview	5-286
5.17.2	Preparation for Deployment.....	5-289
5.17.3	Deployment Guide	5-293
5.18	Smart AP	5-355
5.18.1	Overview	5-355
5.18.2	Preparation for Deployment.....	5-356
5.18.3	Deployment Guide	5-356
6	Solutions.....	6-394
6.1	Bring Your Own Device (BYOD)	6-394
6.1.1	Understanding BYOD	6-394
6.1.2	Configuring BYOD.....	6-395
7	Appendix	7-425
7.1	Ruijie Fit AP&AC EWeb Configuration Guide for RGOS 11.x V1.2.....	7-425
7.2	Ruijie Fat AP EWeb Configuration Guide For RGOS 11.x V1.1.....	7-425
7.3	Import license to AC by CLI or WEB.....	7-425
7.4	Common Verification Commands	7-427

3 Device Management

3.1 System Management

Default Settings

AC: No default IP address.

AP: Default IP address is 192.168.110.1(or 192.168.1.1), and both console & telnet password are "admin", default enable password is "apdebug"

Following wall AP have different default settings

AP120-W

In Fit mode, IP address of both LAN port and Uplink port IP are 192.168.110.1/24

In Fat mode, IP address of LAN port is 192.168.111.1/24; IP address of Uplink port is 192.168.110.1/24

AP110-W

IP address of Rear panel is 192.168.110.1/24

IP address of Front panel is 192.168.111.1/24

3.1.1 Console Management

Connect cables as below diagram

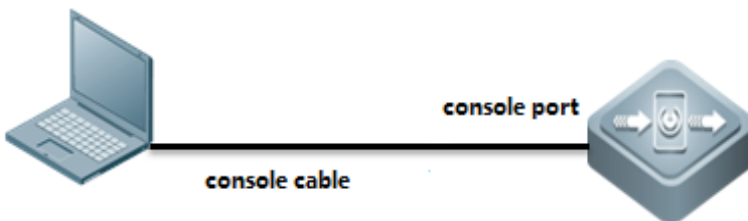

Cables

console cable, USB to RS232 cable



Putty

Open software Putty, set baud rate to 9600

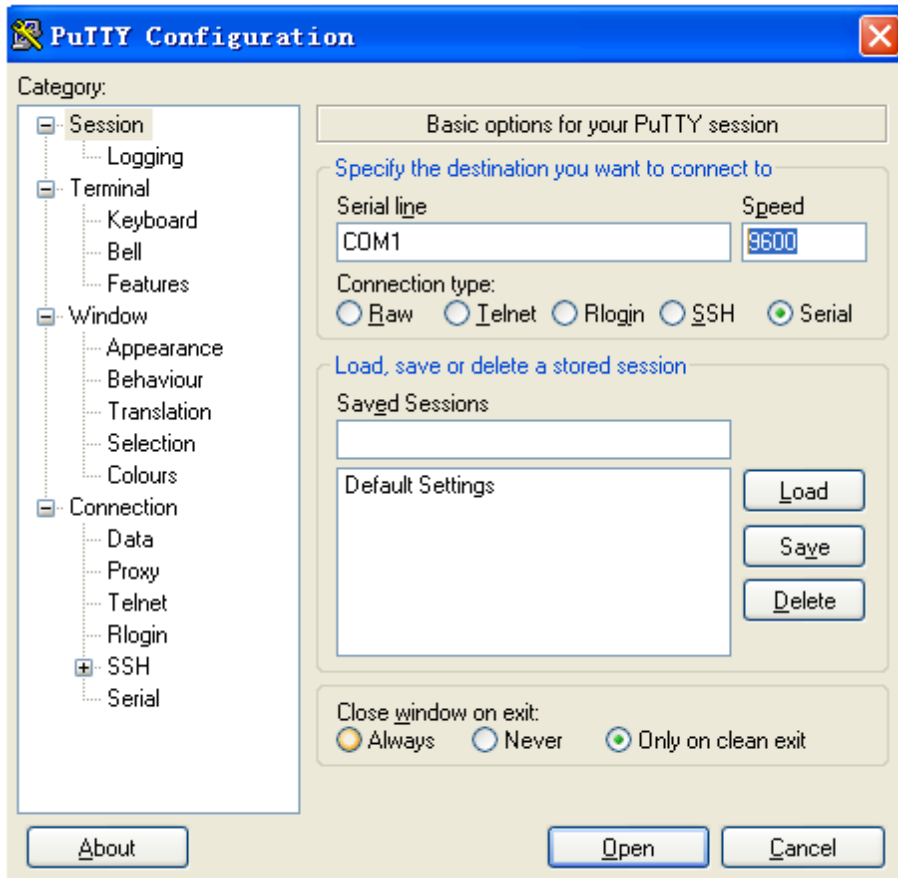

3.1.2 Telnet Management

I. Network Topology

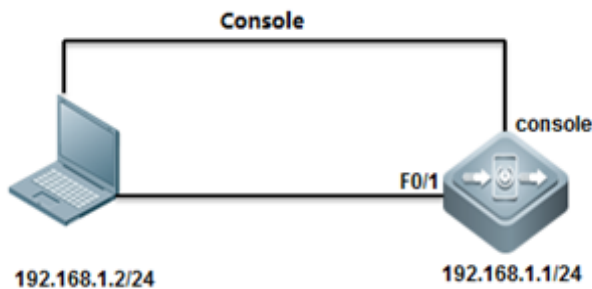

II. Configuration Steps

Configuring Telnet& enable password on AC

```
Ruijie>enable
Ruijie#configure terminal
Ruijie(config)#interface vlan 1
Ruijie(config-if-vlan 1)#ip address 192.168.1.1 255.255.255.0
Ruijie(config)#ip route 0.0.0.0 0.0.0.0 192.168.1.2
Ruijie(config)#line vty 0 4
Ruijie(config-line)#password ruijie
Ruijie(config-line)#login
Ruijie(config)#enable password ruijie
```

Configuring Telnet & Enable password on AP

Console connect to device and set passwords, default ap-mode is fit.

```
User Access Verification
Password: default password is "ruijie"
Ruijie>
Ruijie>enable
Password: default password is "apdebug"
Ruijie#configure terminal
Ruijie(config)#interface bvi 1
Ruijie(config-if-bvi 1)#ip address 192.168.1.1 255.255.255.0
Ruijie(config-if-bvi 1)#interface gigabitEthernet 0/1
Ruijie(config-if-GigabitEthernet 0/1)#encapsulation dot1Q 1
%Warning: Remove all IP address.
Ruijie(config-if-GigabitEthernet 0/1)#exit
Ruijie(config)#ip route 0.0.0.0 0.0.0.0 192.168.1.2
Ruijie(config)#line vty 0 4
Ruijie(config-line)#password ruijie
Ruijie(config-line)#login
Ruijie(config)#enable password ruijie
```

Note: when ap-mode change from fit to fat, the default password changes as follow:

```
User Access Verification
Password: default password is "admin"
Ruijie>
Ruijie>enable
Password: no default password
Ruijie#configure terminal
```

III. Verification

```
C:\Documents and Settings\Administrator>telnet 192.168.1.1
```

```
C:\ Telnet 192.168.1.1
```

```
User Access Verification
```

```
Password:
```

```
Ruijie>
```

```
Ruijie>_
```

```
ruijie>enable
```

```
Password:
```

```
ruijie#
```

```
ruijie#_
```

Save configuration

```
Ruijie(config)#end
```

```
Ruijie#write
```

Note:

windows7&8 telnet client function is not enabled by default, you need to enable the telnet functionality.

Taking Windows 7 as an example:

Control panel - procedures and functions - to open or close the windows function - check the telnet client - select "to determine"

3.1.3 SSH Management

I. Network Topology

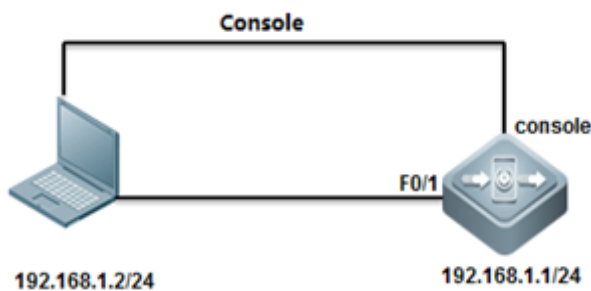

II. Configuration Steps

Configuring SSH on AC

```
Ruijie>enable
Password:
Ruijie#configure terminal
Ruijie(config)#enable service ssh-server
Ruijie(config)#crypto key generate dsa
Choose the size of the key modulus in the range of 360 to 2048 for your
Signature Keys. Choosing a key modulus greater than 512 may take
a few minutes.
How many bits in the modulus [512]:
% Generating 512 bit DSA keys. ..[ok]
Ruijie(config)#interface vlan 1
Ruijie(config-if-VLAN 1)#ip address 192.168.1.1 255.255.255.0
Ruijie(config)#ip route 0.0.0.0 0.0.0.0 192.168.1.2
Ruijie(config)#enable password ruijie
```

Method 1: Login with password

```
Ruijie(config)#line vty 0 4
Ruijie(config-line)#password ruijie
Ruijie(config-line)#login
Ruijie(config-line)#end
Ruijie#write
Building configuration...
[OK]
Ruijie#
```

Method 2: Login with username & password

```
Ruijie(config)#line vty 0 4
Ruijie(config-line)#login local
Ruijie(config-line)#exit
Ruijie(config)#username admin password ruijie
Ruijie(config)#end
Ruijie#write
Building configuration...
[OK]
Ruijie#
```

III. Verification

Open Putty, choose Connection type "SSH", input IP address.

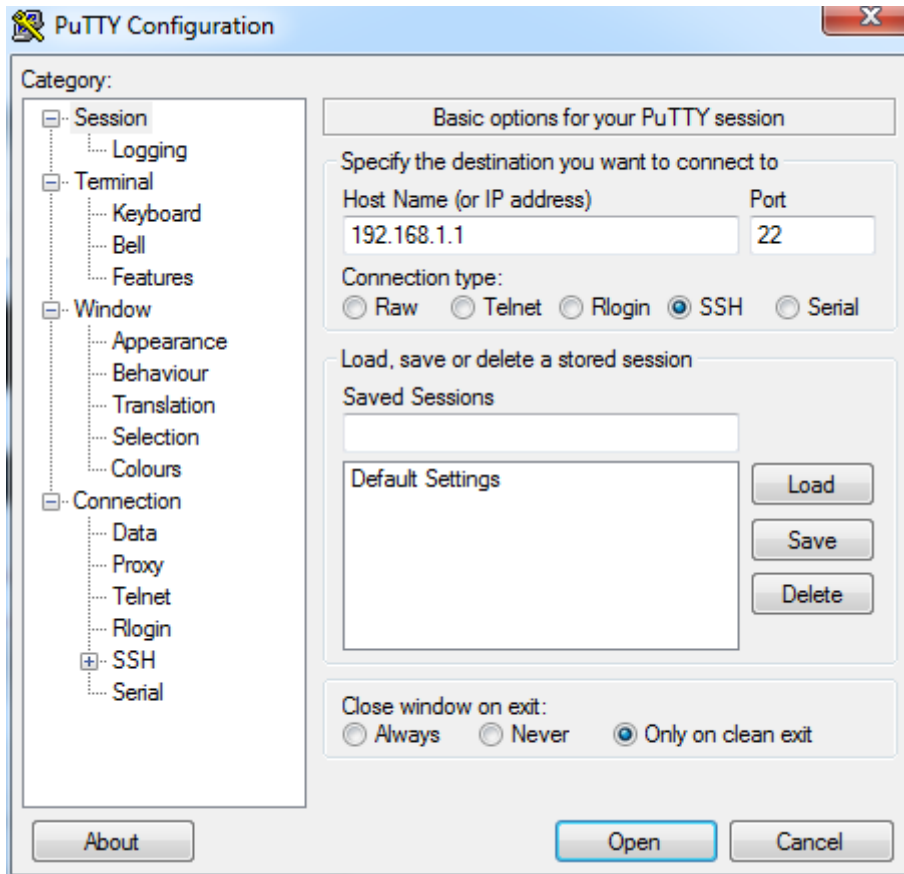

To display SSH service status, execute following commands

```
Ruijie#show service
ssh-server      : enabled
telnet-server   : enabled
web-server      : enabled
snmp-agent      : enabled
Ruijie#
```

```
Ruijie#show ssh
Connection Version Encryption      Hmac      State      Username
0          2.0 aes256-cbc      hmac-shal Session started admin
Ruijie#
```

```
Ruijie#show users
Line      User      Host(s)      Idle      Location
0 con 0
* 1 vty 0   admin     idle        00:00:00  192.168.1.2
Ruijie#
```

3.1.4 Web Management

I. Network Topology

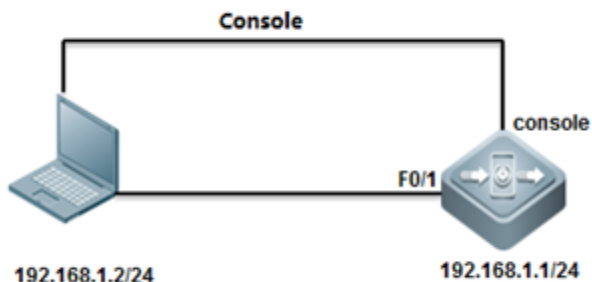

II. Configuration Steps

Configuring WEB GUI on AC

```
Ruijie#configure terminal
Ruijie(config)#enable service web-server
Ruijie(config)#vlan 1
Ruijie(config-vlan)#interface vlan 1
Ruijie(config-if-VLAN 1)#ip address 192.168.1.1 255.255.255.0
Ruijie(config-if-VLAN 1)#exit
Ruijie(config)#webmaster level ?
<0-2> Web auth privilege level (0 is the highest level)
Ruijie(config)#webmaster level 0 username ruijie password ruijie
Ruijie(config)#ip route 0.0.0.0 0.0.0.0 192.168.1.254
```

Note:

1. **AM5528 does not support web management.**
2. **Only user “admin” and “ruijie” could be created on cli page, for other account, if you have the web management requirements, please create it on web interface, relative err prompt are shown as follow:**

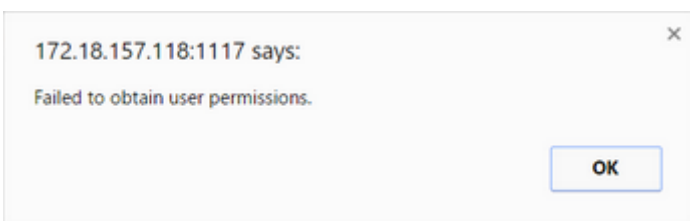

III. Verification

Visit web GUI at <http://192.168.1.1>, it is recommended that access WEB GUI with IE 8.0 and above version in compatible mode.



Access Control

Wireless Control, Communication
Everywhere

[Forget your password?](#)[简体中文 ▶](#)

 | ©2000-2015Ruijie Networks Co., Ltd. | [BBS](#) | [Mail](#) | [FAQs](#) | Tel: 4008 111 000

3.1.5 Forget IP Address of Wall AP

If administrator forgot IP address of Wall-AP, and do not want to recover factory setting, follow below steps:

1. Power on AP, and connect AP as below diagram:

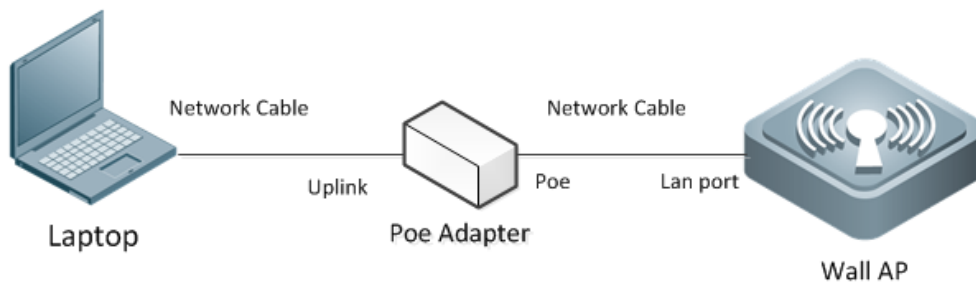

2. Open packet capture tool, here take Wireshark as example:

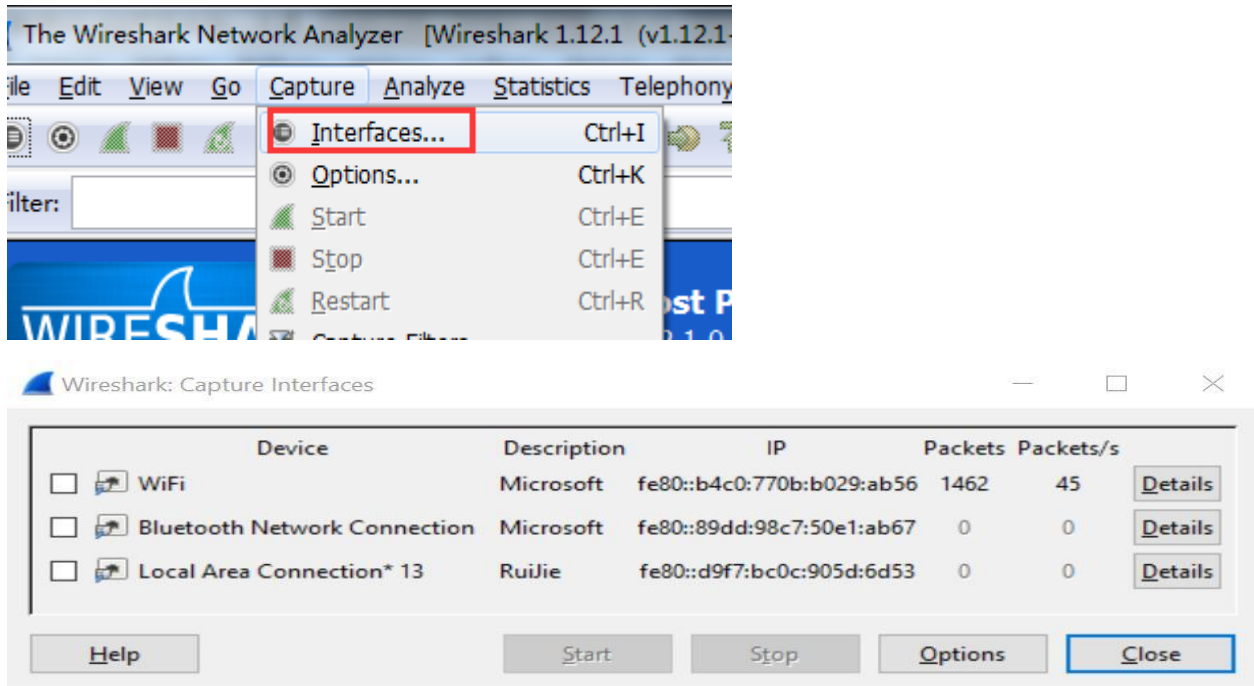

3. Check ARP packets, and 192.168.51.54 is correct IP

Destination	Protocol	Length	Info
d:6b:9e Broadcast	ARP	42	who has 192.168.51.1? Tell 192.168.51.54

4. Try to telnet AP
5. If above method doesn't work, suggest to restore factory default.

3.2 Firmware Upgrade

3.2.1 Upgrade for RGOS 11.x

3.2.1.1 Upgrade AC & Fit AP (for 11.X)

I. Network Topology

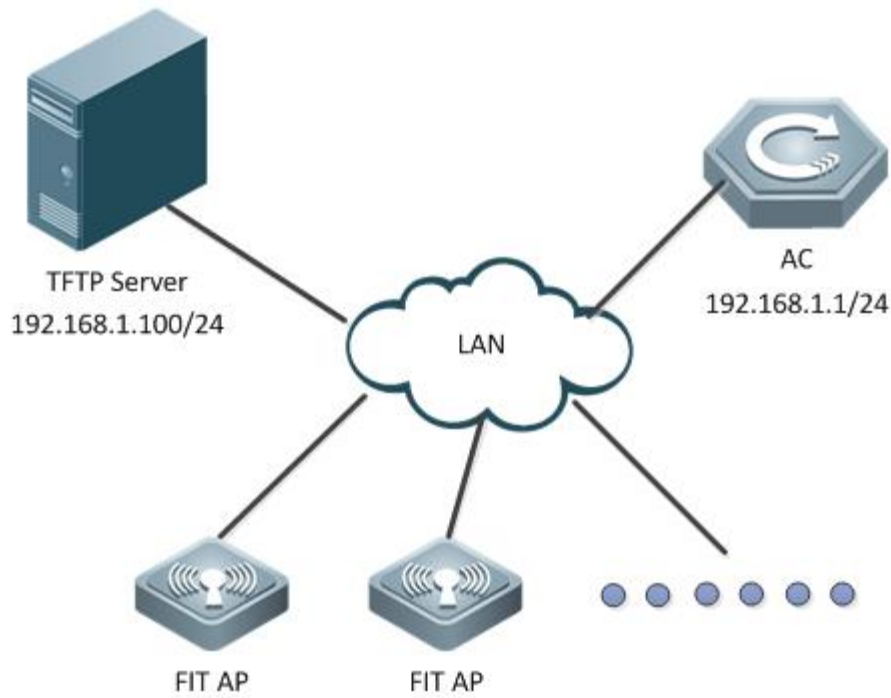

II. Requirements

1. Visit official website at www.ruijienetworks.com to request firmware.

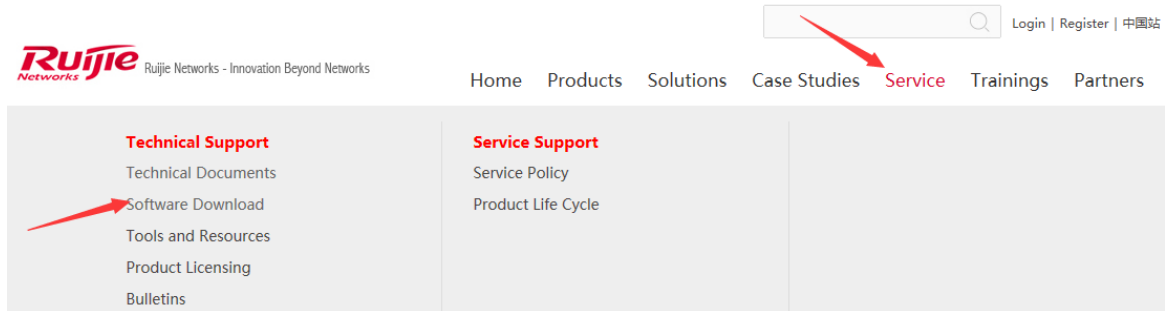

2. Run TFTP Server, and put AP&AC firmware in the same folder. Here take Ruijie TFTPServer as example.

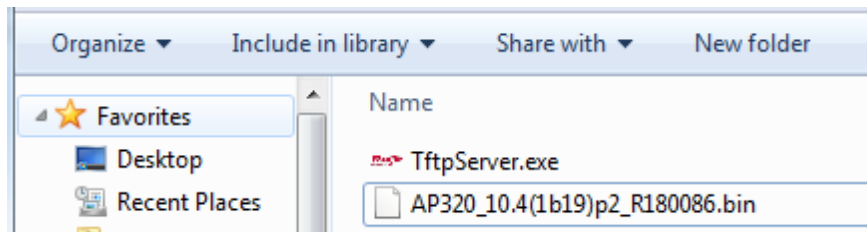

TFTP Server should be able to communicate with AC.

3. AC has built CAPWAP tunnel with APs
4. Read Release Note carefully, pay attention to the "upgrade file"
5. DO NOT restart or POWER OFF AC&AP during upgrades.
6. Login AC CLI via console, telnet or SSH.

III. Configuration Steps

Upgrading AC

Attention: In hot-backup scenario, please remove all networks cables on ACs in case of synchronization issue caused by inconsistent firmware.

1. Display current firmware version and backup relative configuration files.

```
Ruijie# copy flash:config.text tftp://192.168.1.100/config.text --->backup the configuration files of AC to TFTP Server.
```

```
Ruijie# copy flash:ap-config.text tftp://192.168.1.100/ap-config.text ---> backup the configuration of AP to TFTP Server.
```

```
Ruijie#show version detail
```

```
System description      : Ruijie 10G Wireless Switch(WS6008) By Ruijie Networks.
System uptime           : 0:02:15:24
System hardware version: 1.0
System software version: AC_RGOS 11.1(5)B80P3, Release(04131820)
System patch number     : NA
System software number  : M20361001182017
System serial number    : 1234942570002
System boot version     : 2.0.19.97cfa98(161210)
System core version     : 2.6.32.355270930a6bde
System cpu partition    : 4-11
```

2. Transfer new firmware to AC, execute below commands:

```
Ruijie#upgrade download tftp://192.168.1.100/rgos.bin
```

III. Verification

After reloading, execute command "show version" to verify firmware version.

```
Ruijie#show version detail
```

```
System description      : Ruijie 10G Wireless Switch(WS6008) By Ruijie Networks.
System uptime           : 0:02:15:24
System hardware version: 1.0
System software version: AC_RGOS 11.1(5)B80P3, Release(04131820)
System patch number     : NA
System software number  : M20361001182017
System serial number    : 1234942570002
System boot version     : 2.0.19.97cfa98(161210)
```

```
System core version   : 2.6.32.355270930a6bde
System cpu partition  : 4-11
```

Upgrading Fit APs

Attention: Generally, the fit ap and ac can work normally only when the versions of them are consistent

1. Display current ap firmware version on AC, execute commands "show version all"

```
Ruijie#show version detail
System description    : Ruijie Indoor AP330-I (802.11a/n and 802.11b/g/n) By Ruijie Networks.
System start time     : 1969-12-31 23:59:59
System uptime: 0:00:01:09
System hardware version: 1.10      ----->hardware version
System software version: AP_RGOS 11.1(5)B3, Release(02160403)----->software version
System patch number   : NA
System software number : M03112104042015
System serial number: G1GDB16019485
System boot version   : 1.1.1.6822c2a(140920)
System core version   : 2.6.32.ab930e7d22374b
```

2. To transfer AP new firmware to AC, execute below commands:

```
Ruijie#copy tftp://192.168.1.100/330.bin flash:330.bin
Press Ctrl+C to quit
!!!!!!!!!!!!!!!!!!!!!!!!!!!!!!!!!!!!!!
Copy success
```

3. To configure ap-serial, execute below commands:

```
Ruijie(config)#ac-controller
Ruijie(config-ac)#active-bin-file flash:330.bin
Ruijie(config-ac)#ap-image auto upgrade
```

4. After AP reloading, APs will establish CAPWAP tunnel with AC.

III. Verification

1. Display AP upgrading progress, execute commands "show ap-config updating-list"

```
Ruijie#show ap-config updating-list
AP NAME                AP PID          File Tx          Time
AP Reset Ready
-----
AP330-I                AP330-I        20 %            00:00:06      N
```

2. Display current ap firmware version on AC, execute commands "show version all"

```
Ruijie>show version
```

```
System description      : Ruijie Indoor AP330-I (802.11a/n and 802.11b/g/n) By Ruijie Networks.
System start time      : 1970-01-01 00:00:01
System uptime: 0:00:01:52
System hardware version: 1.10
System software version: AP_RGOS 11.1(5)B5, Release(02182520)
System patch number    : NA
System serial number: G1GDB16019485
System boot version    : 1.1.1
```

3.2.1.2 Upgrade Fat AP (for 11.X)

I. Network Topology

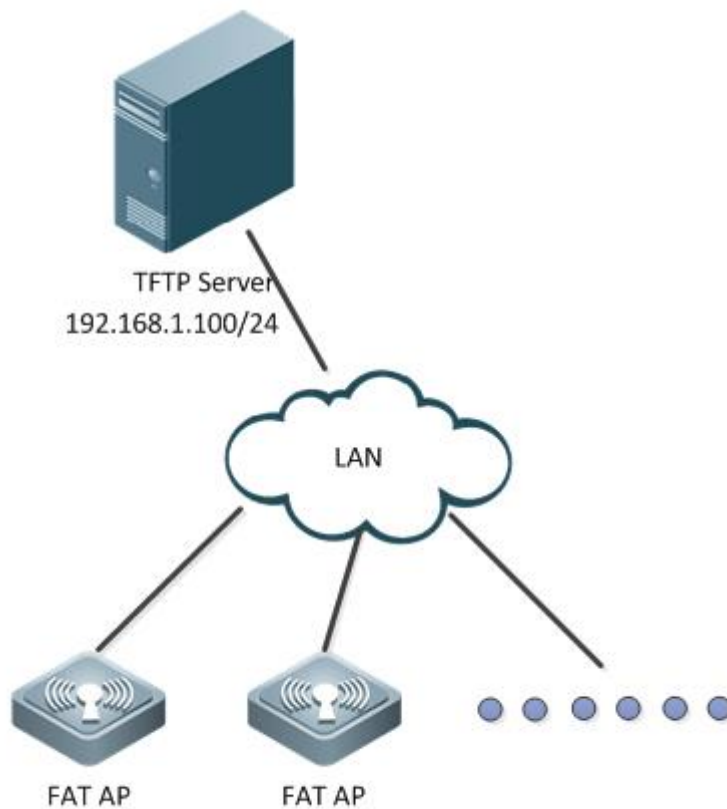

II. Requirements

1. Visit official website at www.ruijienetworks.com to request firmware.

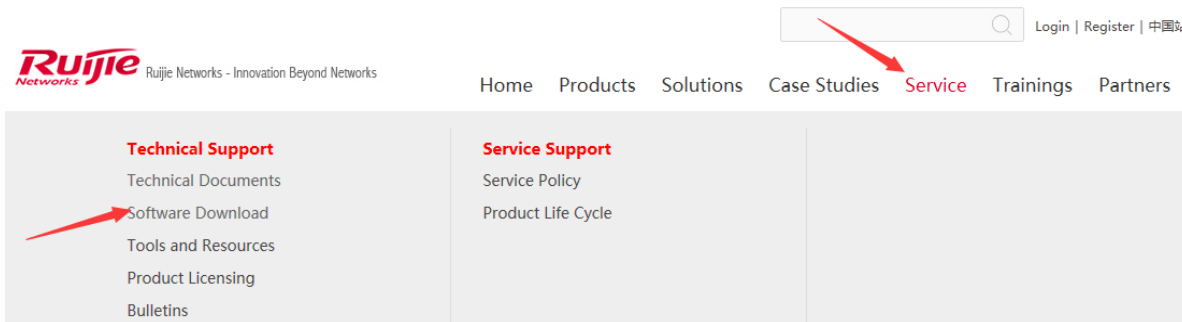

2. Run TFTP Server, and put AP firmware in the same folder. Here take Ruijie TFTPServer as example.

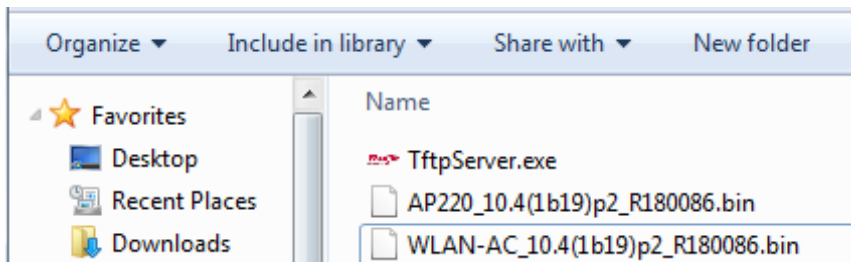

TFTP Server should be able to communicate with AP.

- 3. Read Release Note carefully, pay attention to the "upgrade file"
- 4. DO NOT restart or POWER OFF AP during upgrades.
- 5. Login AP CLI via console, telnet or SSH.

Attention: Wall APs, like AP130 (W2) & AP130L, do not have console port. See [Device Management -->Conventions](#) to learn the default IP address.

III. Configuration Steps

Upgrading FAT APs

1. Backup configuration files to TFTP Server, and display current firmware version

```
Ruijie#copy flash:config.text tftp://192.168.1.100/config.text --->backup configuration files of AP to TFTP Server

Ruijie#show version detail ---> check version
System description      : Ruijie Indoor AP330-I (802.11a/n and 802.11b/g/n) By Ruijie Networks.
System start time       : 1969-12-31 23:59:59
System uptime: 0:00:01:09
System hardware version: 1.10
System software version: AP_RGOS 11.1(5)B3, Release(02160403)
System patch number     : NA
```

```
System software number : M03112104042015
System serial number   : G1GDB16019485
System boot version    : 1.1.1.6822c2a(140920)
System core version    : 2.6.32.ab930e7d22374b
```

2. Display current ap mode

```
AP320#show ap-mode
current mode: fat
AP320#
```

3. Transfer new firmware to AP, execute below commands:

```
Ruijie#upgrade download tftp://192.168.1.100/330-b5.bin
Upgrade the device must be auto-reset after finish, are you sure upgrading now?[Y/n]y
Running this command may take some time, please wait.
Please wait for a moment.....
Press Ctrl+C to quit
!!!!!!!!!!!!!!!!!!!!!!!!!!!!!!!!!!!!!!!!!!!!

Begin to upgrade the install package 330-b5.bin... --->reload automatically
*Jan  1 00:03:52: %7: Upgrade processing is 10%
Uncompress file 330-b5.bin. ....
```

IV. Verification

After reloading, execute command "show version" to verify firmware version.

```
Ruijie#show version detail
System description      : Ruijie Indoor AP330-I (802.11a/n and 802.11b/g/n) By Ruijie Networks.
System start time      : 1970-01-01 00:00:01
System uptime: 0:00:01:09
System hardware version: 1.10
System software version: AP_RGOS 11.1(5)B5, Release(02182520)
System patch number    : NA
System software number : M20085306252015
System serial number   : G1GDB16019485
System boot version    : 1.1.1.6822c2a(140920)
System core version    : 2.6.32.720c78d1a03d63
```

3.2.2 Upgrade from RGOS 10.x to 11.x

3.2.2.1 Upgrade AC & Fit AP from 10.X to 11.X

I. Network Topology

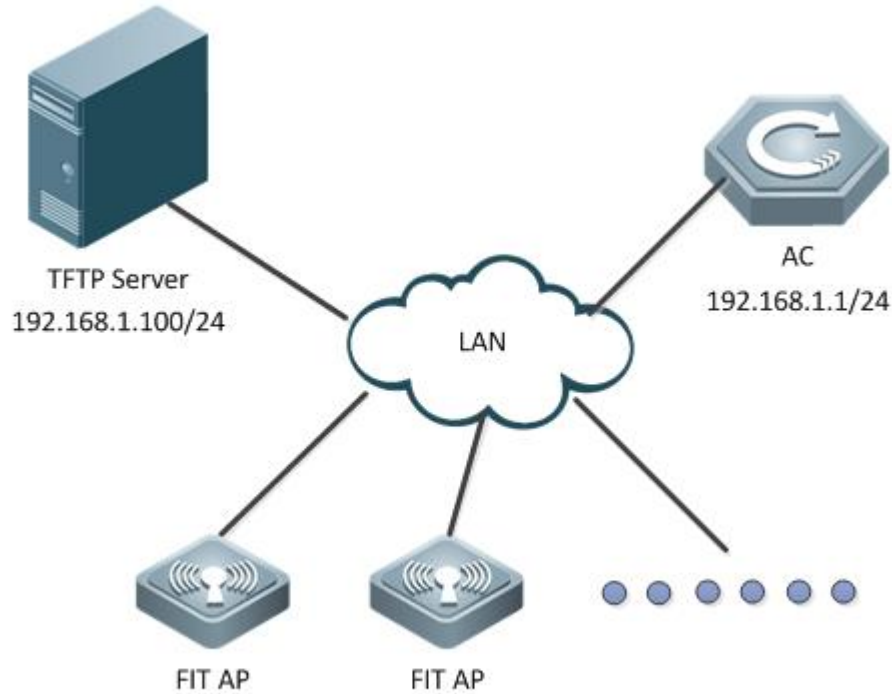

II. Requirements

1. Visit official website at www.ruijienetworks.com to request firmware..

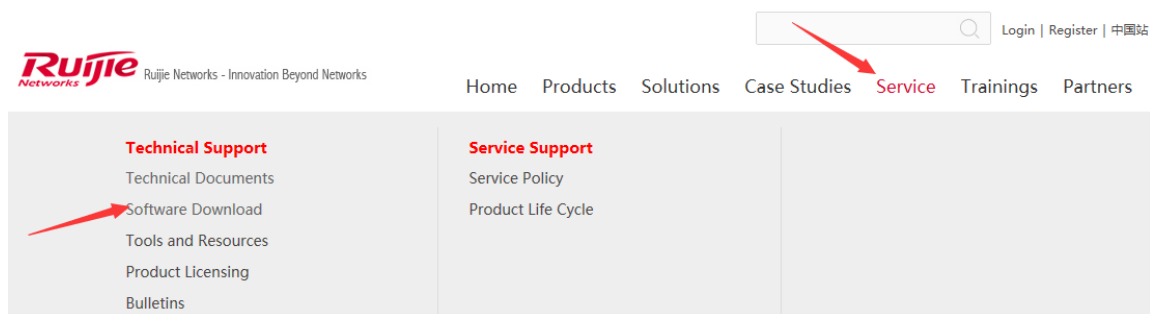

2. Run TFTP Server, and put AP&AC firmware in the same folder. Here take Ruijie TFTPServer as example.

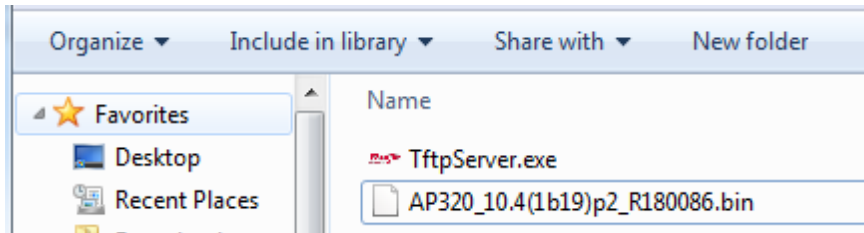

TFTP Server should be able to communicate with AC.

3. AC has built CAPWAP tunnel with APs
4. Read Release Note carefully, pay attention to the "upgrade file"
5. DO NOT restart or POWER OFF AC&AP during upgrades.
6. Login AC CLI via console, telnet or SSH.

III. Configuration Steps

Upgrading AC

Attention: In hot-backup scenario, please remove all networks cables on ACs in case of synchronization issue caused by inconsistent firmware.

1. Display current firmware version and backup relative configuration files.

```
Ruijie#copy flash:config.text tftp://172.18.158.204/config.text --->backup the configuration files of AC to TFTP Server.
```

```
Ruijie#copy flash:ap-config.text tftp://172.18.158.204/ap-config.text ---> backup the configuration of AP to TFTP Server.
```

```
WS5302#sh version
System description      : Ruijie Gigabit Wireless Switch(WS5302) By Ruijie Networks.
System start time      : 2016-07-20 10:30:11
System uptime         : 0:0:40:0
System hardware version : 1.10
System software version : RGOS 10.4(1b19)p2, Release(179742)
System boot version    : 10.4.184919
System serial number   : G1G40KL001209
```

2. Transfer new firmware to AC, execute below commands:

```
Ruijie#copy tftp://172.18.158.204/AC_RGOS10.x_TO_11.x(Mid)_G1C5-01_02172111.bin flash:rgos.bin
```

After reloading, execute command "show version" to verify firmware

```
Ruijie#sh version
System description      : Ruijie Gigabit Wireless Switch(WS5302) By Ruijie Networks.
System start time      : 2016-07-20 11:19:21
System uptime         : 0:00:01:16
System hardware version : 1.10
System software version : AC_RGOS 10.x_TO_11.x(Mid), Release(02172111)
System patch number    : NA
System serial number   : G1G40KL001209
System boot version    : 2.0.1
```

3. Because the configuration files will lost when upgrade to mid version, need to import the config.text, and test the

connection between AC and terminal, then Downgrade AC to target version 11.x

```
Ruijie#upgrade download tftp://192.168.1.100/AC_RGOS11.1(5)B8_G1C5-01_03151003_install.bin
```

IV. Verification

After reloading, execute command "show version" to verify firmware version

```
WS5302#sh version
System description      : Ruijie Gigabit Wireless Switch(WS5302) By Ruijie Networks.
System uptime          : 0:00:00:56
System hardware version : 1.10
System software version : AC_RGOS 11.1(5)B8, Release(03151003)
System patch number    : NA
System serial number    : G1G40KL001209
System boot version     : 2.0.1
```

Upgrading Fit APs

1. Transfer 11.x and mid version of AP to AC, execute below commands:

```
Ruijie#copy tftp://172.18.158.204/AP_RGOS10.x_TO_11.x(Mid)_S2C3-01_02201910.bin flash:ap530-mid.bin
Ruijie#copy tftp://172.18.158.204/AP_RGOS11.1(5)B8_S2C3-01_03151007_install.bin flash:ap530.bin
```

2. To configure ap-serial, execute below commands:

```
Ruijie(config)#ac-controller
Ruijie(config-ac)#active-bin-file ap530-mid.bin rgos10
Ruijie(config-ac)#active-bin-file ap530.bin
Ruijie(config-ac)#ap-serial ap530 AP530-I hw-ver 1.x
Ruijie(config-ac)#ap-image ap530-mid.bin ap530
Ruijie(config-ac)#ap-image ap530.bin ap530
```

IV. Verification

1. After reloading, execute command "show version" to verify firmware version

```
ap530-i#sh version
System description      : Ruijie Indoor AP530-I (802.11a/n/ac and 802.11b/g/n/ac) By Ruijie Networks.
System uptime          : 0:00:36:48
System hardware version : 1.50
System software version : AP_RGOS 11.1(5)B8, Release(03151007)
System patch number    : NA
System serial number    : G1KD11L044265
System boot version     : 3.0.0
```

2. After AP reloading, APs will build CAPWAP tunnel with AC.

```
WS5302#sh capwap sta
CAPWAP tunnel state, 1 peers, 1 is run:
Index      Peer IP      Port      State      Mac Address
1          192.168.10.2 10000     Run        5869.6c5b.de0f
```

3.2.2.2 Upgrade Fat AP from 10.X to 11.X

I. Network Topology

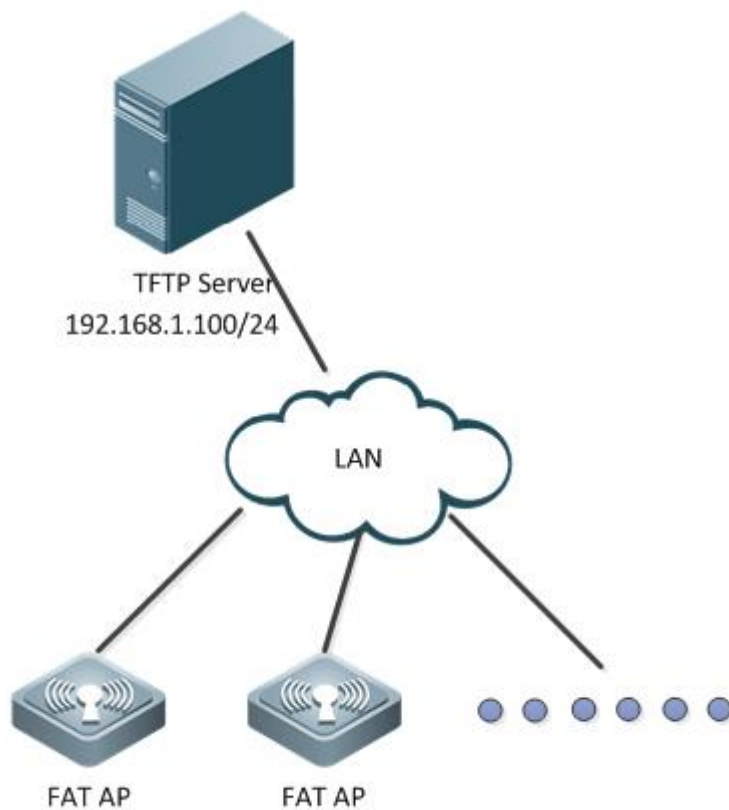

II. Requirements

1. Visit official website at www.ruijienetworks.com to request firmware.

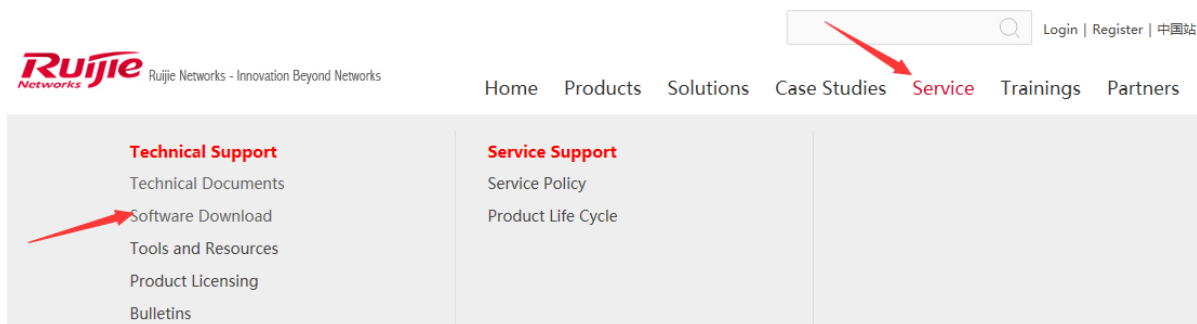

2. Run TFTP Server, and put AP firmware in the same folder. Here take Ruijie TFTPServer as example.

AP_RGOS11.1(5)B8_S2C3-01_0315100...	2016/3/31 16:24	BIN 文件	19,915 KB
AP_RGOS11.x_TO_10.x(Mid)_S2C3-01_...	2015/7/17 9:23	BIN 文件	20,071 KB
AP530-PPC_10.4(1b19)p2_R179742.bin	2015/5/5 15:49	BIN 文件	8,508 KB
TftpServer.exe	2016/6/13 21:06	应用程序	1,703 KB

5. reload and verification

```

Ruijie#sh version
System description      : Ruijie Indoor AP530-I (802.11a/n/ac and 802.11b/g/n/ac) By Ruijie Networks.
System uptime          : 0:00:00:56
System hardware version : 1.50
System software version : AP_RGOS 11.1(5)B8, Release(03151007)
System patch number    : NA
System serial number   : G1kD11L044265
System boot version    : 3.0.0

```

3.2.3 Downgrade from RGOS 11.x to 10.x

3.2.3.1 Downgrade the AC & Fit AP from 11.X to the 10.X

I. Network Topology

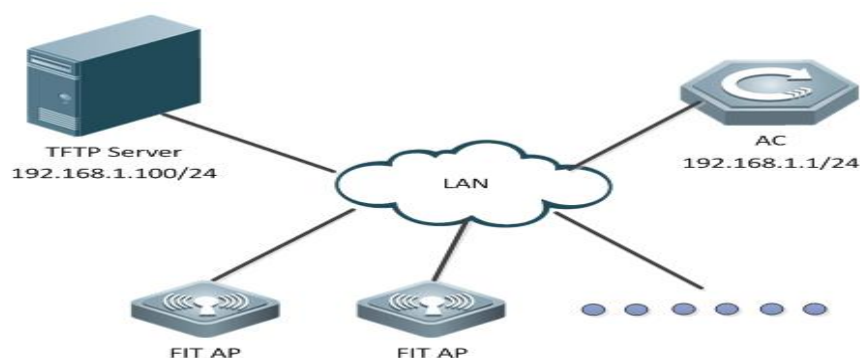





II. Requirements

1. Visit official website at www.ruijienetworks.com to request firmware.

The screenshot shows the Ruijie Networks website. The 'Service' menu item is highlighted in red. The 'Service' menu is expanded, showing the following options:

- Technical Support**
 - Technical Documents
 - Software Download
 - Tools and Resources
 - Product Licensing
 - Bulletins
- Service Support**
 - Service Policy
 - Product Life Cycle

2. Run TFTP Server, and put AP firmware in the same folder. Here take Ruijie TFTPServer as example.

 AP_RGOS11.1(5)B8_S2C3-01_0315100...	2016/3/31 16:24	BIN 文件	19,915 KB
 AP_RGOS11.x_TO_10.x(Mid)_S2C3-01_...	2015/7/17 9:23	BIN 文件	20,071 KB
 AP530-PPC_10.4(1b19)p2_R179742.bin	2015/5/5 15:49	BIN 文件	8,508 KB
 TftpServer.exe	2016/6/13 21:06	应用程序	1,703 KB

TFTP Server should be able to communicate with AP.

3. Read Release Note carefully, pay attention to the "upgrade file"
4. DO NOT restart or POWER OFF AP during upgrades.
5. Login AP CLI via console, telnet or SSH.

Attention: Downgrade from 11.X to 10.X, configuration will lost, backup the configuration before downgrading; need to downgrade to mid version first.

III. Configuration Tips

Downgrading FIT APs

1. Backup configuration files on ac
2. Transfer mid version of AP to AC

TFTP Server should be able to communicate with AC.

3. Active version of AP
4. Read Release Note carefully, pay attention to the "downgrade file"
5. DO NOT restart or POWER OFF AC&AP during upgrades.
6. Login AC CLI via console, telnet or SSH.

IV. Configuration Steps

Downgrading AC

Attention: In hot-backup scenario, please remove all networks cables on ACs in case of synchronization issue caused by inconsistent firmware.

1. Display current firmware version

```
WS5302#sh version
System description      : Ruijie Gigabit Wireless Switch(WS5302) By Ruijie Networks.
System uptime          : 0:00:31:53
System hardware version : 1.10
System software version : AC_RGOS 11.1(5)B8, Release(03151003)
System patch number    : NA
System serial number   : GLG40KL001209
System boot version    : 2.0.1
```

Downgrading Fit APs

1. To transfer AP new firmware to AC, execute below commands:

```
Ruijie#copy tftp://192.168.1.100/AP_RGOS11.1(2)B1_AP320_v2.0_degrade.bin flash:320-mid.bin
```

- 2 To configure ap-serial, execute below commands:

```
Ruijie#config terminal
Ruijie(config)#ac-controller
Ruijie(config-ac)#active-bin-file 320-mid.bin
Ruijie(config-ac)#ap-serial ap320 AP320-I hw-ver 1.x
Ruijie(config-ac)#ap-image ap320-mid.bin ap320
Ruijie(config-ac)#end
Ruijie#wr
```

2. telnet APs and verify the current version

```
Ruijie#show version
System description      : Ruijie Indoor AP320-I (802.11a/n and 802.11b/g/n) By Ruijie Networks.
System start time      : 1970-01-01 0:0:0
System uptime: 0:0:0:44
System hardware version: 1.10
System software version: RGOS 10.4(1b19)p2, Release(175879)
System boot version    : 10.4.155446(Master), 10.4.155446(Slave) ->mid version of AP
System serial number   : G1GDC13025434
```

3. Downgrade AC from 11.X to 11.X_to_10.X(Mid), execute below commands:

```
Ruijie#upgrade download tftp://172.18.158.204/AC_RGOS11.x_TO_10.x(Mid)_G1C5-02_02172016.bin force
```

Verification

After reloading, execute command "show version" to verify firmware

```
Ruijie#sh version
System description      : Ruijie Gigabit Wireless Switch(WS5302) By Ruijie Networks.
System start time      : 2016-07-20 10:15:47
System uptime         : 0:0:0:29
System hardware version: 1.10
System software version: AC_RGOS 11.x_TO_10.x(Mid), Release(02172016)
System boot version    : 10.4.184919
System serial number   : G1G40KL001209
```

4. Because the configuration files will lost when downgrade to mid version, need to import the config.text, and test the connection between AC and terminal, then Downgrade AC to target version 10.x

```
Ruijie#copy tftp://172.18.158.205/WLAN-AC-50XX_10.4(1b19)p2_R179742.bin flash:rgos.bin
Ruijie#reload
```

Verification

```
Ruijie#sh version
System description      : Ruijie Gigabit Wireless Switch(WS5302) By Ruijie Networks.
System start time      : 2016-07-20 10:30:11
System uptime         : 0:0:0:36
System hardware version: 1.10
System software version: RGOS 10.4(1b19)p2, Release(179742)
System boot version    : 10.4.184919
System serial number   : G1G40KL001209
```

5. After downgrading the AC, the configuration will loss, need to import the ac configuration.

```
Ruijie#copy tftp://192.168.1.100/config.text flash:config.text
Ruijie#copy tftp://192.168.1.100/ap-config.text flash:ap-config.text
Ruijie#reload
```

6. Downgrade AP to target version 10.x

```
Ruijie#copy tftp://192.168.1.100/AP320_10.4(1b19)p2_R179742.bin flash 320I.bin
Ruijie#configure terminal
Ruijie(config)#ac-controller
Ruijie(config-ac)#active-bin-file 320I.bin
Ruijie(config-ac)#ap-serial ap320 AP320-I hw-ver 1.x
Ruijie(config-ac)#ap-image 320I.bin ap320
Ruijie(config-ac)#end
Ruijie#wr
```

V. Verification

```
Ruijie#show version
System description      : Ruijie Indoor AP320-I (802.11a/n and 802.11b/g/n) By Ruijie Networks.
System start time      : 2015-01-05 12:37:41
System uptime: 4:0:24:8
System hardware version: 1.10
System software version: RGOS 10.4(1b19)p2, Release(179742)
System boot version    : 10.4.155446(Master), 10.4.155446(Slave)
System serial number   : G1GD91300419A
```

3.2.3.2 Downgrade the Fat AP from 11.X to the 10.X

I. Network Topology

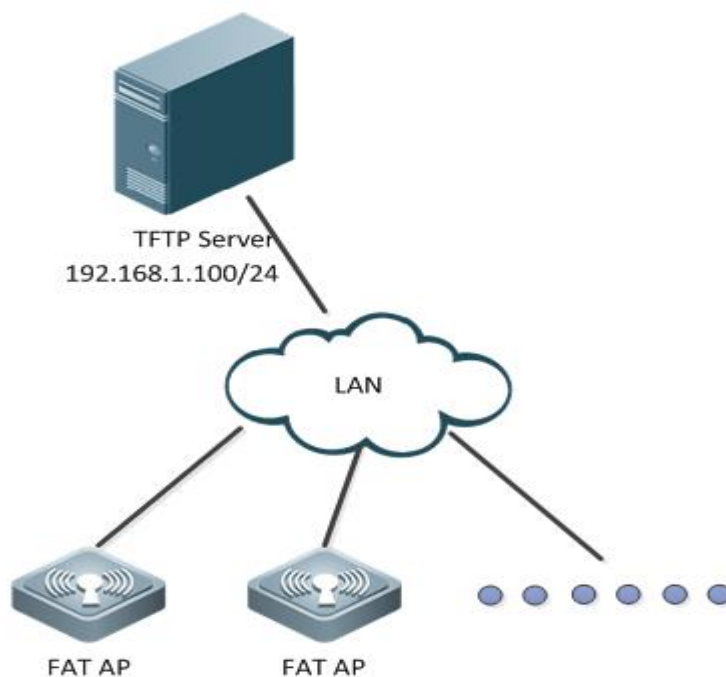

II. Requirements

1. Visit official website at www.ruijienetworks.com to request firmware.

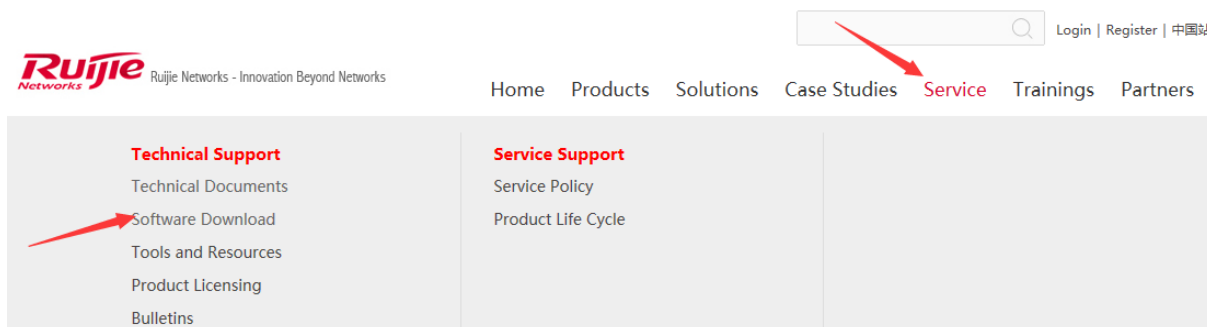

2. Run TFTP Server, and put AP firmware in the same folder. Here take Ruijie TFTPServer as example.

AP_RGOS11.1(5)B8_S2C3-01_0315100...	2016/3/31 16:24	BIN 文件	19,915 KB
AP_RGOS11.x_TO_10.x(Mid)_S2C3-01_...	2015/7/17 9:23	BIN 文件	20,071 KB
AP530-PPC_10.4(1b19)p2_R179742.bin	2015/5/5 15:49	BIN 文件	8,508 KB
TftpServer.exe	2016/6/13 21:06	应用程序	1,703 KB

TFTP Server should be able to communicate with AP.

3. Read Release Note carefully, pay attention to the "upgrade file"
4. DO NOT restart or POWER OFF AP during upgrades.
5. Login AP CLI via console, telnet or SSH.

Attention: Downgrade from 11.X to 10.X, configuration will lost, backup the configuration before downgrading; need to downgrade to mid version first.

III. Configuration Steps

Downgrading FAT APs

1. Backup configuration files to TFTP Server, and display current firmware version

```
Ruijie#copy flash:config.text tftp://192.168.111.2/config.text --->backup configuration files of AP to TFTP Server
```

```
Ruijie#sh version
System description      : Ruijie Indoor AP530-I (802.11a/n/ac and 802.11b/g/n/ac) By Ruijie Networks.
System uptime          : 0:00:05:32
System hardware version : 1.50
System software version : AP_RGOS 11.1(5)B8, Release(03162915)
System patch number    : NA
System serial number    : G1KD11L044265
System boot version     : 3.0.0
```

2. Display current ap mode

```
Ruijie#show ap-mode
current mode: fat
```

3. Transfer new firmware to AP, execute below commands:

```
Ruijie#upgrade download tftp://192.168.111.2/AP_RGOS11.x_TO_10.x(Mid)_S2C3-01_02180712.bin
Upgrade the device must be auto-reset after finish, are you sure upgrading now?[Y/n]y
Running this command may take some time, please wait.
Please wait for a moment.....
Press Ctrl+C to quit
!!!!!!!!!!!!!!!!!!!!!!!!!!!!!!!!!!!!!!!!!!!!!!
*Jan  1 00:04:27: %7:
*Jan  1 00:04:27: %7: Begin to upgrade the install package
AP_RGOS11.x_TO_10.x(Mid)_S2C3-01_02180712.bin...
*Jan  1 00:04:27: %7: Upgrade processing is 10%
RG-UPGRADE:package.c:621]Old md5 value(/rootfs.ubi):
[RG-UPGRADE:rpm_opt.c:374]:e2d4e747428247db1ca518ade88d0bb1
```

Verification

```
Ruijie#sh version
System description      : Ruijie Indoor AP530-I (802.11a/n/ac and 802.11b/g/n) By Ruijie Networks.
System start time      : 1970-01-01 0:0:0
System uptime          : 0:0:0:53
System hardware version : 1.50
System software version : AP_RGOS 11.x_TO_10.x(Mid), Release(02180109)
System boot version    : 10.4.166620(Master), 10.4.166620(Slave)
System serial number    : G1KD11L044265
```

4. downgrade to target version 10.x

```
Ruijie#copy tftp://192.168.111.2/AP530-PPC_10.4(1b19)p2_R179742.bin flash:rgos.bin
```

5. reload and verification

```
Ruijie#sh version
System description      : Ruijie Indoor AP530-I (802.11a/n/ac and 802.11b/g/n) By Ruijie Networks.
System start time      : 1970-01-01 0:0:0
System uptime          : 0:0:9:8
System hardware version : 1.50
System software version : RGOS 10.4(1b19)p2, Release(179742)
System boot version    : 10.4.166620(Master), 10.4.166620(Slave)
System serial number   : G1KD11L044265
```

3.2.4 Recover Firmware under BOOT

3.2.4.1 AC & AP with Console Port

I. Network Topology

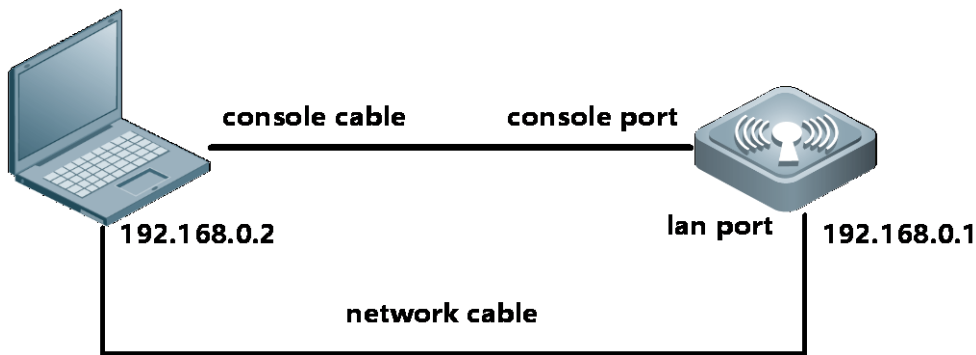

II. Requirements

1. Generally, we recover firmware under BOOT mode if we delete firmware on Main Mode by mistake, firmware broken or any other unknown reasons that devices cannot boot up and enter Main Mode.
2. Finish reading [Device Management --> System Management --> Firmware Upgrade](#), have knowledge of how to transfer firmware with TFTP server.
3. It's applicable for both AC and APs with console port. Not applicable for Wall APs without console port.

Note: remember to turn off Windows Defender protection and system firewall.

III. Configuration Steps

1. Restart devices, press "CTRL + C" when system prompts, enter BOOT Mode, Input 0

```

Press Ctrl+C to enter Boot Menu  0
Net:  eth0
Entering simple UI...

===== BootLoader Menu("Ctrl+Z" to upper level) =====
TOP menu items.
*****
0. Tftp utilities.
1. XModem utilities.
2. Run main.
3. SetMac utilities.
4. Scattered utilities.
*****
Press a key to run the command: 0
    
```

2. Input 1, then upgrade firmware with the following steps.

```

===== BootLoader Menu("Ctrl+Z" to upper level) =====
Tftp utilities.
*****
0. Upgrade bootloader.
1. Upgrade kernel and rootfs by install package.
2. Down to memory and jump to run.
*****
Press a key to run the command: 1
Plz enter the Local IP: [192.168.110.1]:
Plz enter the Remote IP: [192.168.110.2]:
Plz enter the Filename: [AP530-PPC_10.4(1b19)p2_R179742.bin]: AP_RGOS11.1(5)B8_s2c3-01_03151007_install.bi
Erasing SPI flash...Writing to SPI flash...done
Auto-update from TFTP: trying update file 'AP_RGOS11.1(5)B8_s2c3-01_03151007_install.bin'
Speed: 1000, full duplex
Using eTSEC1 device
TFTP from server 192.168.110.2; our IP address is 192.168.110.1
Filename 'AP_RGOS11.1(5)B8_s2c3-01_03151007_install.bin'.
Load address: 0x1000000
Loading: #####
          #####
          #####
    
```

3. Input "yes"

```

done
Bytes transferred = 20392244 (1372934 hex)
Uncompressing 0x137211d@0x1000817 to 0x195b6e4@0x2372934
Uncompressed 0x195b6e4 bytes
Get boot addr 0x0,len 0x0; kernel addr 0x0,len 0x0; rootfs addr 0x
Package information:
  rootfs version:1.0.0.40442fb4
  rootfs target :ap530-ppc
Determined to upgrade? [Y/N]: y
Upgrading, keep power on and wait please ...
Erasing SPI flash...Writing to SPI flash...done
    
```

4. Press "CTRL+Z" return to upper level, then choose "2" to run main

```

===== BootLoader Menu("Ctrl+Z" to upper level) =====
TOP menu items.
*****
0. Tftp utilities.
1. XModem utilities.
2. Run main.
3. SetMac utilities.
4. Scattered utilities.
*****
Press a key to run the command: 2
Unmounting UBIFS volume rootfs!
UBI: mtd1 is detached from ubi0
Creating 1 MTD partitions on "nor0":

```

IV. Verification

Devices succeed to enter Main mode, execute command "show version", check the firmware version.

Ruijie#show version

```

Ruijie#sh version
System description      : Ruijie Indoor AP530-I (802.11a/n/ac and 802.11b/g/n/ac) By Ruijie Networks.
System uptime          : 0:00:00:56
System hardware version : 1.50
System software version : AP_RGOS 11.1(5)B8, Release(03151007)
System patch number     : NA
System serial number    : G1KD11L044265
System boot version     : 3.0.0

```

3.2.4.2 Wall AP without Console Port

I. Network Topology

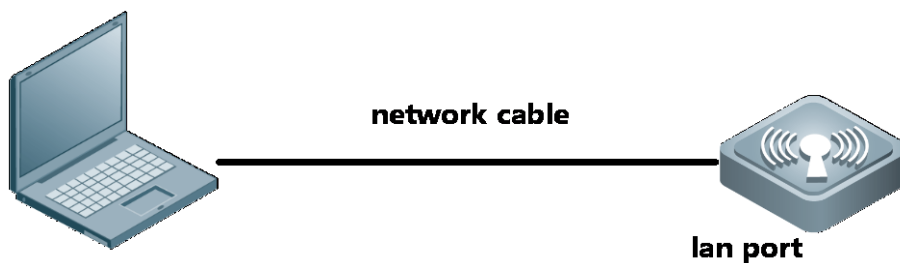

II. Requirements

1. Generally, we recover firmware under BOOT mode if we deletes firmware on Main Mode by mistake, firmware broken or any other unknown reasons that devices cannot boot up and enter Main Mode.
2. Finish reading [Device Management --> System Management & --> Firmware Upgrade](#), have knowledge of how to transfer firmware with TFTP server.

III. Configuration Steps

1. Open Wireshark, load a packet capture process as below. AP 192.168.64.163 lost firmware and is requesting 192.168.64.1 for firmware.

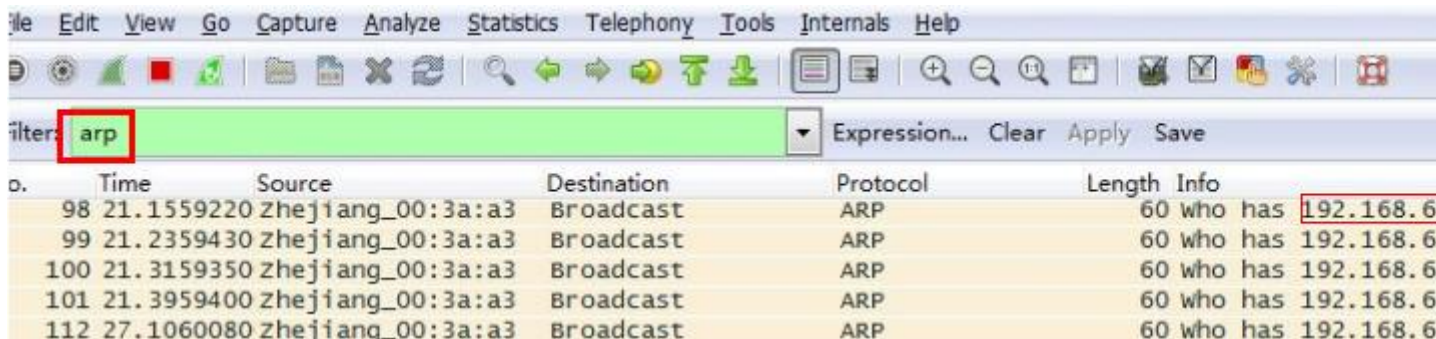

2. Assign IP address 192.168.64.1 to laptop, enable TFTP Server and also prepare the firmware.

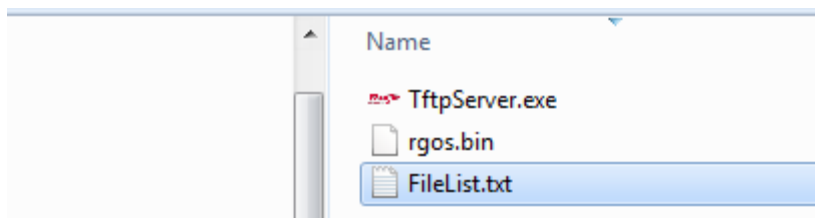

2. Edit a notepad name as "FileList.txt", put it in the same folder as shown above, the content is the firmware name you're going to transfer

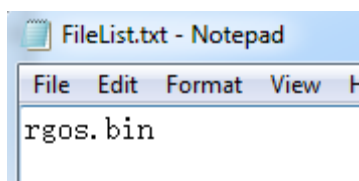

4. AP will begin downloading firmware soon, verify by viewing TFTP Server connection status.
5. AP will reload when finish recovering firmware

IV. Verification

Login AP via telnet and AP is recovered.

3.3 Password Recovery

3.3.1 Recover AC & Fat AP password

I. Network Topology

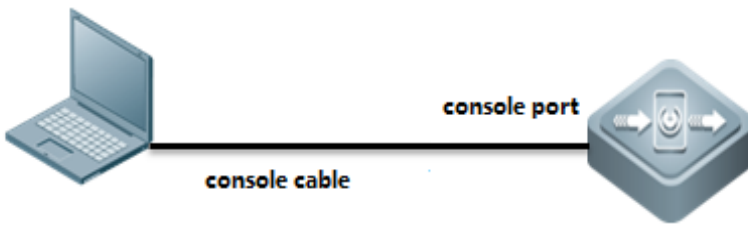

II. Requirements

1. Finish reading [System Management --> Console Management](#).
2. Login AC CLI via Console.

III. Configuration Steps

Recovering AC password (configuration file remains)

1. Power off AC, then power up.
2. Press CTRL + C, enter CTRL mode.

```
*Dec 22 11:06:40: %LINK-3-UPDOWN: Interface GigabitEthernet 0/1, changed state to up.
*Dec 22 11:06:40: %LINEPROTO-5-UPDOWN: Line protocol on Interface GigabitEthernet 0/1, changed s

Boot 1.1.6-00475-gae7d9d6 (Development build) (Build time: Sep  4 2014 - 18:35:35)

Press Ctrl+C to enter Boot Menu
DRAM: 2 GiB
Clearing DRAM..... done
Flash: 2 MiB
NAND: 512 MiB
In: serial
Out: serial
Err: serial
SETMAC: Setmac operation was performed at 1970-01-01 00:00:00 (version: 11.0)
BIST check passed.
PAL rev: 0.00, MCU rev: 0.00, CPU voltage: 0.00
WS5708 board revision major:1, minor:0, serial #: unknown
OCTEON CNS6500 NSP pass 2.1, Core clock: 750 MHz, DDR clock: 400 MHz (800 Mhz data rate)
Net: octmgm0, octeth0, octeth1, octeth2, octeth3
Entering simple UI...

----- BootLoader Menu("Ctrl+Z" to upper level) -----
  TOP menu items.
*****
  0. Tftp utilities.
  1. XModem utilities.
  2. Run main.
  3. SetMac utilities.
  4. Scattered utilities.
*****
Press a key to run the command:
```

3. Input CTRL+Q, enter uboot mode. And then input "main_config_password_clear"

```

===== BootLoader Menu("Ctrl+Z" to upper level) =====
TOP menu items.
*****
 0. Tftp utilities.
 1. XModem utilities.
 2. Run main.
 3. SetMac utilities.
 4. Scattered utilities.
*****
Press a key to run the command:
Oxteon ws5708# main_config_password_clear

```

4. Device will reload automatically.

```

Sep 12 00:41:12: %LINK-3-UPDOWN: Interface Loopback 0, changed state to up.
Sep 12 00:41:12: %LINEPROTO-5-UPDOWN: Line protocol on Interface Loopback 0, changed state to up.
Sep 12 00:41:14: %LINK-3-UPDOWN: Interface GigabitEthernet 0/1, changed state to up.
Sep 12 00:41:14: %LINEPROTO-5-UPDOWN: Line protocol on Interface GigabitEthernet 0/1, changed state to up.
Sep 12 00:41:14: %LINEPROTO-5-UPDOWN: Line protocol on Interface VLAN 1, changed state to up.
Sep 12 00:41:14: %LINEPROTO-5-UPDOWN: Line protocol on Interface VLAN 2, changed state to up.
Sep 12 00:41:14: %LINEPROTO-5-UPDOWN: Line protocol on Interface VLAN 555, changed state to up.
Sep 12 00:41:14: %LINEPROTO-5-UPDOWN: Line protocol on Interface VLAN 1401, changed state to up.
Sep 12 00:41:14: %APMG-6-INTF_MAP_CLI_ADD: ADD wlan-vlan-radio(1 - 2 - all) mapping to group(Default).
Sep 12 00:41:14: %APMG-6-INTF_MAP_CLI_ADD: ADD wlan-vlan-radio(2 - 2 - all) mapping to group(Default).
Sep 12 00:41:14: %APMG-6-INTF_MAP_CLI_ADD: ADD wlan-vlan-radio(1 - 2 - all) mapping to group(Test).
Sep 12 00:41:15: %CARMAP-6-ADDRESS_CHANGE: Get new address [11.11.11.11] with Interface [Loopback 0] now.
Lower slot #1 pull out!
Sep 12 00:41:16: %LOCALEAP-6-PKIMANAGE: Self-signed PKI is activated
Sep 12 00:41:16: %LOCALEAP-6-PKIMANAGE: Self-signed PKI is currently used

Press RETURN to get started
Sep 12 00:41:23: %SNFPP_ARP_GUARD-4-SCAN: Host<IP=172.18.200.2,MAC=001a.a97d.9b7, port=GI0/1,VLAN=2> was detected.(2008-9-12 0:41:23)
Sep 12 00:41:47: %SNFPP_ARP_GUARD-4-SCAN: Host<IP=N/A,MAC=001a.a9c2.4609,port=GI1/1,VLAN=2> was detected.(2008-9-12 0:41:47)

```

3. When finish reloading, enter CLI without input password.

```

Ruijie>
Ruijie>en
Ruijie#

```

Note: The default timeout period is 10min. Please change your password before time out.

4. Change password, and then use the command “wr” to save your configuration.

```

Ruijie#conf
Enter configuration commands, one per line. End with CTRL-Z
Ruijie(config)#enable secret ruijie
Ruijie(config)#line vty 0 4
Ruijie(config-line)#password ruijie
Ruijie(config-line)#login
Ruijie(config-line)#end

```

5. save configuration

```

Ruijie#wr
Building configuration...
[OK]

```

Re-login AC, execute commands "show running-config" to check configurations.

3.4 Restore Factory Default

3.4.1 Restoring AC & FAT AP

I. Requirements

1. Finish reading Device Management --> System Management
2. Login CLI via console, telnet or SSH

II. Configuration Steps

Execute command "dir" to check file system

```
Ruijie#dir
  Mode Link      Size           MTime Name
-----
      1      1600 1970-01-02 01:31:10 config.text
      1     11729 2015-06-18 02:03:26 cw_tearardown_info.txt
<DIR>  1           0 1970-01-01 00:00:00 dev/
      1          33 2015-06-03 00:04:25 dhcp_bind.dat
<DIR>  4           0 1970-01-01 00:00:18 pkistore/
<DIR>  5           0 1970-01-01 00:00:11 portal/
<DIR>  0           0 1970-01-01 00:00:00 proc/
<DIR>  1           0 1970-01-01 00:00:01 ram/
      1     1529 2015-03-09 16:31:28 reset.txt
      1   8359680 2015-03-09 16:31:26 rgos.bin
<DIR>  2           0 1970-01-01 00:00:08 tmp/
      1    150740 1970-01-01 00:00:12 ucs_big5.db
      1    239708 1970-01-01 00:00:12 ucs_gb.db
<DIR>  4           0 1970-01-01 00:00:12 web/
      1   2766752 1970-01-01 00:00:10 web_management_pack.upd
-----
12 Files (Total size 12243866 Bytes), 7 Directories.
Total 132120576 bytes (126MB) in this device, 115515392 bytes (110MB) available.
```

"config.text" is configuration file, execute commands "del config.text" to set factory default

```
Ruijie#del config.text
Are you sure you want to delete "config.text"?[Yes/No]y
Ruijie#reload
```

```
Processed with reload? [no]y
```

After reloading, execute commands "show running-config" to check configuration.

3.4.2 Restoring FIT AP

I. Requirements

1. Finish reading Device Management --> System Management
2. Login CLI via console, telnet or SSH

II. Configuration Steps

Restore Factory Default

```
AC#conf t
AC(config)#ac-controller
AC(config-ac)#reset ?
all      Reset the all APs in this AC.
single   Reset the single ap.
```

Then the fit ap will restart automatically.

III. Verification

After reloading, execute commands "show running-config" to check configuration.

3.4.3 Restoring WALL AP

Especially, for Wall AP including AP110W, AP120W, AP130W

Long press "reset" button more than 8 seconds to set factory default.

3.5 Backup Configuration

3.5.1 Backup to Flash

I. Requirements

1. Finish reading [System Management](#)
2. Login device CLI via Console, telnet or SSH.

II. Configuration Steps

Execute command "dir" to check file system

```

WS6008#dir
Directory of flash:/
Number  Properties   Size           Time                               Name
-----  -
 1      drwx         160B          Mon Oct 10 19:27:37 2016 dev
 2      drwx         160B          Mon Mar 21 17:32:15 2016 rep
 3      drwx         224B          Mon Mar 21 17:32:16 2016 var
 4      drwx         160B          Mon Oct 10 19:27:40 2016 addr
 5      -r--        4.1k          Wed Nov  2 16:27:00 2016 tmp_env.txt
 6      -rwx         5.0k          Mon Mar 21 17:32:36 2016 hwd.db
 7      -rw-        2.9k          Tue Oct 11 12:39:39 2016 virtual_switch.text
 8      drwx         304B          Mon Mar 21 17:32:42 2016 security
 9      -rwx         180B          Fri Nov  4 16:48:45 2016 config_vac.dat
10      -rw-       14.8k          Fri Nov  4 16:48:46 2016 config.text
11      -rwx         384B          Thu Sep 29 10:21:54 2016 LIC-WLAN-AP-3200000003956646.lic
12      -rwx         18B           Mon Sep 26 17:35:26 2016 test.txt
13      -rw-        718B          Tue Oct 11 09:14:18 2016 ap-standalone.text
14      -rwx         696B          Mon Mar 21 17:32:30 2016 httpd_cert.crt
15      -rwx         21B           Fri Nov  4 16:48:45 2016 syslog_rfc5424_flag.txt
16      drwx         424B          Tue Mar 29 16:50:43 2016 portal
17      -rwx       44.4M          Mon Oct 31 18:20:17 2016
AM_RGOS11.1(5)B9_G1B5-01_03211300_install.bin
18      -rwx         620B          Tue Oct 11 12:39:27 2016 rsa_private.bin
19      -rwx         336B          Sun Oct 30 15:32:36 2016 dsa_private.bin
20      -rw-         5.8k          Thu Jun 30 14:35:03 2016 text.bak
21      -rwx         384B          Wed Oct 12 17:17:05 2016 LIC-WLAN-AP-3200000003466646.lic
22      drwx         296B          Thu Oct 13 13:45:02 2016 upgrade
23      drwx         160B          Fri Nov  4 09:36:26 2016 tech_vsd0
24      drwx         448B          Thu Sep 29 11:24:06 2016 rg_licns
25      drwx         312B          Mon Oct 10 19:57:36 2016 syslog
26      -rw-        147B          Tue Oct 11 12:39:39 2016 ap-virtual_switch.text
27      -rw-       723B          Fri Nov  4 16:48:46 2016 ap-config.text
28      -rwx        187.1k          Fri Nov  4 18:27:03 2016 log-13-may-5.txt
29      -rwx        77.8M          Mon Oct 31 20:23:11 2016
AC_RGOS11.1(5)B9_G2C6-01_03201812_install.bin.up.tmp
30      -rwx         887B          Mon Mar 21 17:32:30 2016 httpd_key.pem
31      -rw-         8.9k          Tue Oct 11 09:14:18 2016 standalone.text
21 files, 10 directories

```

```
281,903,104 bytes data total (155,267,072 bytes free)
```

```
536,870,912 bytes flash total (155,267,072 bytes free)
```

"config.text" is configuration file, execute commands "copy flash:config.text flash:config.bak" to backup configuration file
"ap-config.text" is ap configuration file, execute commands "copy flash:ap-config.text flash:ap-config.bak" to backup ap configuration file

```
Ruijie#
Ruijie#copy flash:config.text flash:config.bak
Ruijie#copy flash:ap-config.text flash:ap-config.bak
```

III. Verification

To view backup file, execute command "dir" to display filesystem. The file size should match.

```
WS6008#dir
Directory of flash:/
Number  Properties   Size           Time                               Name
-----  -
 1      drwx         160B          Mon Oct 10 19:27:37 2016  dev
 2      drwx         160B          Mon Mar 21 17:32:15 2016  rep
 3      drwx         224B          Mon Mar 21 17:32:16 2016  var
 4      drwx         160B          Mon Oct 10 19:27:40 2016  addr
 5      -r--        4.1k          Wed Nov  2 16:27:00 2016  tmp_env.txt
 6      -rwx         5.0k          Mon Mar 21 17:32:36 2016  hwd.db
 7      -rw-         2.9k          Tue Oct 11 12:39:39 2016  virtual_switch.text
 8      drwx         304B          Mon Mar 21 17:32:42 2016  security
 9      -rwx         180B          Fri Nov  4 16:48:45 2016  config_vac.dat
10     -rw-        14.8k          Fri Nov  4 16:48:46 2016  config.text
11     -rwx         384B          Thu Sep 29 10:21:54 2016  LIC-WLAN-AP-3200000003956646.lic
12     -rwx         18B           Mon Sep 26 17:35:26 2016  test.txt
13     -rw-         718B          Tue Oct 11 09:14:18 2016  ap-standalone.text
14     -rwx         696B          Mon Mar 21 17:32:30 2016  httpd_cert.crt
15     -rwx         21B           Fri Nov  4 16:48:45 2016  syslog_rfc5424_flag.txt
16     drwx         424B          Tue Mar 29 16:50:43 2016  portal
17     -rwx        44.4M          Mon Oct 31 18:20:17 2016
AM_RGOS11.1(5)B9_G1B5-01_03211300_install.bin
18     -rwx         620B          Tue Oct 11 12:39:27 2016  rsa_private.bin
19     -rwx         336B          Sun Oct 30 15:32:36 2016  dsa_private.bin
20     -rw-        14.8k          Fri Nov  4 19:08:10 2016  config.bak
21     -rw-         5.8k          Thu Jun 30 14:35:03 2016  text.bak
22     -rwx         384B          Wed Oct 12 17:17:05 2016  LIC-WLAN-AP-3200000003466646.lic
23     drwx         296B          Thu Oct 13 13:45:02 2016  upgrade
24     drwx         160B          Fri Nov  4 09:36:26 2016  tech_vsd0
```

```
25      drwx      448B      Thu Sep 29 11:24:06 2016  rg_licns
26      -rw-      723B      Fri Nov  4 19:08:21 2016  ap-config.bak
27      drwx      312B      Mon Oct 10 19:57:36 2016  syslog
28      -rw-      147B      Tue Oct 11 12:39:39 2016  ap-virtual_switch.text
29      -rw-      723B      Fri Nov  4 16:48:46 2016  ap-config.text
30      -rwx      187.1k    Fri Nov  4 18:27:03 2016  log-13-may-5.txt
31      -rwx      77.8M      Mon Oct 31 20:23:11 2016
AC_RGOS11.1(5)B9_G2C6-01_03201812_install.bin.up.tmp
32      -rwx      887B      Mon Mar 21 17:32:30 2016  httpd_key.pem
33      -rw-      8.9k      Tue Oct 11 09:14:18 2016  standalone.text
23 files, 10 directories
281,903,104 bytes data total (155,394,048 bytes free)
536,870,912 bytes flash total (155,394,048 bytes free)
```

Tips: To read text file in CLI, exeute command "more config.bak"

```
WS6008#more config.bak
version AC_RGOS 11.1(5)B9, Release(03201812)
hostname WS6008
!
wlan-config 1 cmcp
  ssid-code utf-8
!
wlan-config 2 Eweb_BA832
  ssid-code utf-8
  band-select enable
  schedule session 2
!
wlan-config 3 Eweb_BA833
  ssid-code utf-8
!
wlan-config 4 oversea123
  ssid-code utf-8
!
wlan-config 5 Eweb_BA835
  ssid-code utf-8
!
wlan-config 13 test-for-sec
!
wlan-config 55 AM5528
  band-select enable
```

3.5.2 Backup to TFTP Server

I. Network Topology

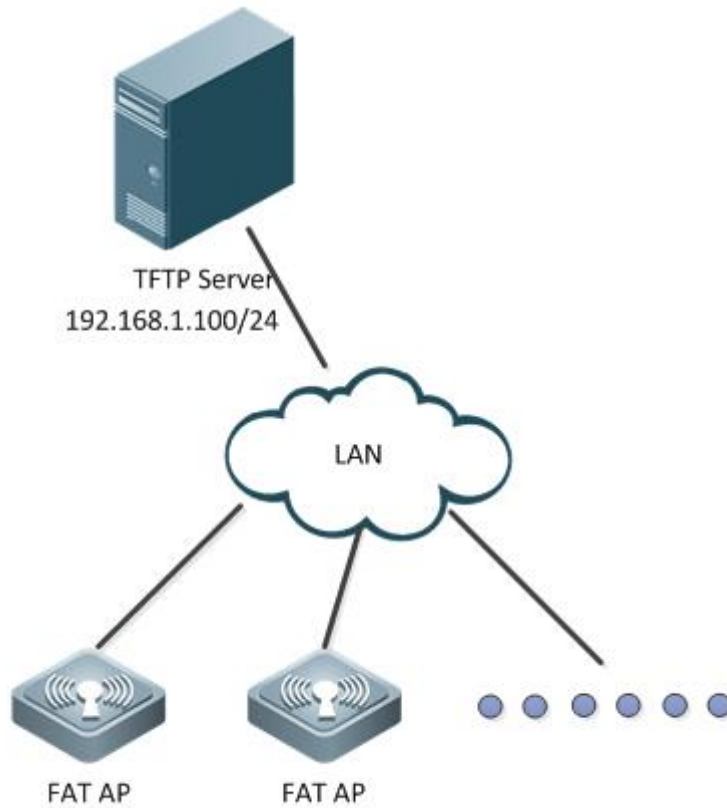

II. Requirements

1. Finish reading [System Management](#)
2. Login device CLI via Console, telnet or SSH.
3. Run TFTP software in the PCs
3. TFTP Server is able to communicate with device

III. Configuration Steps

To copy files in flash to TFTP Server, execute commands "copy flash:config.text tftp:"

```
Ruijie#copy flash:config.text tftp://192.168.1.100/config.text
```

IV. Verification

The backup configuration file will be copied to TFTP Server.

3.6 License Application

Problem: Wireless license import failed.

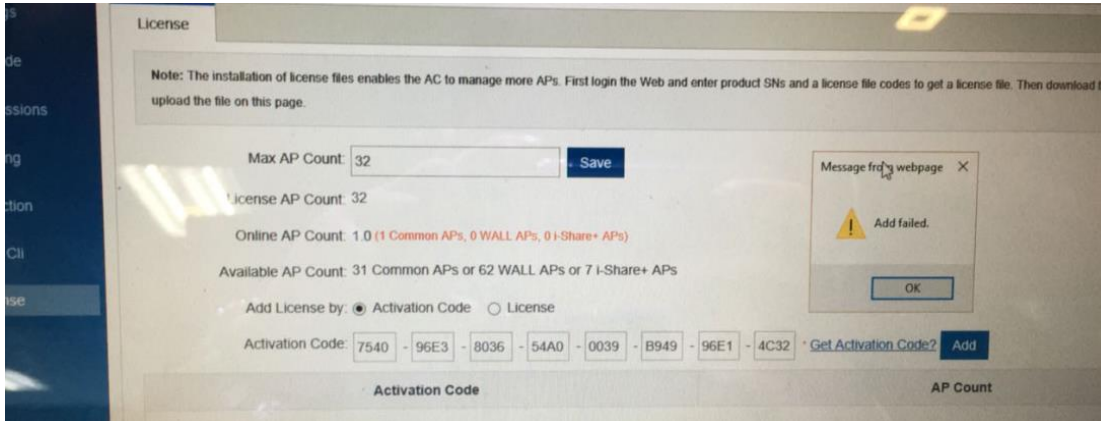

Solution:

1. Confirm whether the SN is correct via the official website.

[Home](#) > [Support](#) > [Product Licensing](#)

Product Licensing



After login successfully, input authorization code, and then click "search" to check whether the relative device SN is consistent with the practical SN.

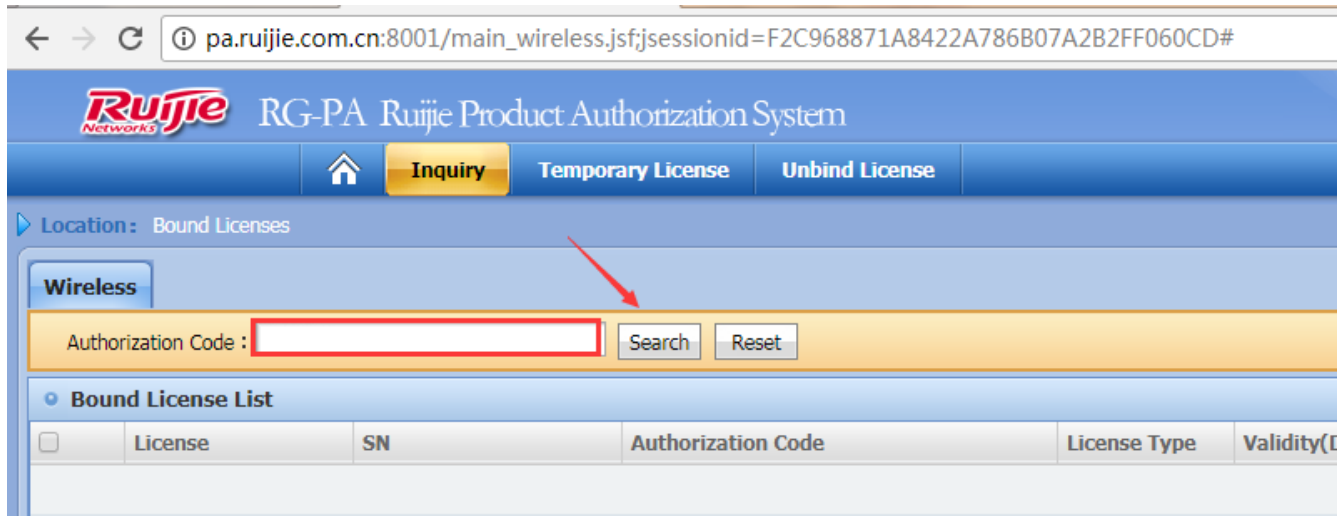

2. If the root case is the incorrect SN, unbind the License first

Step1:

Visit official website (<http://www.ruijienetworks.com/service/License.aspx>), unbind License files.

Click "Service" ->"Support" ->"Product Licensing" ->choose "WLAN" for wireless license unbinding. Choose "Unbind License"-> choose "Wireless"-> click "Unbind License", then click "Complete" after filling in product info.

Note: Before unbinding the license files, you should register first if you do not have an account for login.

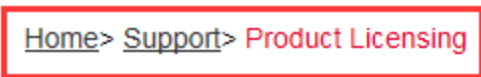

Product Licensing



Then in the pop-up dialog box, click "finish" to submit an application.

The screenshot shows a web browser window with the URL `pa.ruijie.com.cn:8001/main_wireless.jsfjsessionid=F2C968871A8422A786B07A2B2FF060CD#`. The page title is "RG-PA Ruijie Product Authorization System" and the support email is `service_rj@ruijienetworks.com`. The navigation menu includes "Inquiry", "Temporary License", and "Unbind License" (which is highlighted). The main content area is titled "Location: Unbind License" and contains a form with the following fields and instructions:

- * Email :** [Text Input] *Please make sure your Email is correct, receive license files.*
- * Customer :** [Text Input]
- Contact Number :** [Text Input] *Before you unbind your license, we need to contact you for verification. Please make sure your contact number is correct*
- CD Authorization :**
- * SN :** [Text Input]
- * Authorization Code :** [Text Input]
- Validation Code :** [Text Area] *Validation codes must match authorization codes one-to-one in order to succeed. In case of failure Fill out the return order for the 'Application Reason'.*
- * Application Reason :** [Text Area]

Tips : *Please enter your application reason for our reference. We will respond within 48 hours after receiving the application. If you want to use the license again, please apply for a temporary license.*

Buttons: "Complete" and "Cancel".

Step2: After completing the application, submitted it to TAC for application via e-mail account: `service_rj@ruijienetworks.com`. And then waiting for approval.

Click "**Service**" -> "**Support**" -> "**Product Licensing**" -> choose "**WLAN**" for wireless license unbinding. Choose "**Unbind License**" -> choose "**Wireless**" -> Check the approval status, if approved, customer can apply for a new license with the original S/N.

Warm prompt:

After unbind the license successfully, if you have the requirement of Wireless License Registration, please follow the following steps to apply for new license.

Step1: Obtain the license register number.

Open the attachment in the Authorization Letter to obtain the Authentication Code..



Or obtain the authentication code from the CD. There is a pdf file in the CD which is shown as follow:

Ruijie Network
www.ruijie.com.cn

License Certification

Date Issue : 01/09/2013
Purchase Product : Mobility Exchange Licnese Upgrade
Quantity : One
Description : 16 managed MP license upgrade for wlan-ac

Ruijie model : RG_WS_LIC_16

License : 18980



Step2: Visit the official website, bind License files.

Click "**Service**" ->"**Support**" ->"**Product Licensing**" ->choose "**WLAN**" for wireless license binding, after filling in the information, click "Complete", it will jump to the download page of .lic file.

Step3: Install the authorization document

Note: If the license obtained by user is a .lic file, install the license with the following way

i) Upload the local license file to the wlc.

Configuration Example:

```
Ruijie#copy tftp://192.168.64.2/LIC-WLAN-AP-800000015692434.lic flash:/LIC-WLAN-AP- 800000015692434.lic
Press Ctrl+C to quit
!
Copy success.
```

ii) Install license file

Configuration Example:

```
Ruijie# license install flash:LIC-WLAN-AP-800000015692434.lic
Are you sure to install this license[y/n]:y
Success to install license file, service name: LIC-WLAN-AP-8.
```

Step3: Install the authorization document

Note: If the license obtained by user is a license key, install the license with the following way

i) The following shows the similar format of the license obtained by the user

XXXX-XXXX-XXXX-XXXX-XXXX-XXXX-XXXX-XXXX

Record the generated license key, connect to the wlan-ac device, and use the set license license command. If it prompts it is correct, the register application is successful. If it prompts the error, contact the Ruijie Customer Service center for the related consultation.

ii) Configure the License Basic Features

Configuration Example:

```
Ruijie# configure terminal
Enter configuration commands, one per line. End with CNTL/Z.
Ruijie(config)# set license AAAA-BBBB-CCCC-DDDD-EEEE-FFFF-GGGG-HHHH
```

Verification

Showing the License Configuration, you could find you have add new license successfully.

```
Ruijie# show license
```

3.7 FAQ

3.7.1 what traffic is need to be allowed to pass the firewall between the AC and the RADIUS server?

Interaction between the AC and the RADIUS server is generally based on the RADIUS protocol and SNMP. The ports to be opened are:

RADIUS port: Based on UDP. The default authentication port is 1812 and the default accounting port is 1813, which are both on the RADIUS server.

SNMP port: Based on UDP. The port is 161, which is on the AC.

3.7.2 How to kick a user offline

Check the user's MAC address:

```
WS#show ac-con client by-ap-name
```

```
Total Sta Num : 4
```

```
Cnt   STA MACAP NAMEWlan Id   Radio Id   Vlan Id   Valid
```

```
-----  
10021.6a99.6c5aBF2_AP_031122091
```

```
2701a.04a9.a1b2BF2_AP_062123091
```

```
3   0026.c690.0a06   BF7_AP_011122091
```

```
4001f.3b3b.b435BF7_AP_011122091
```

Kick the user offline:

```
WS(config)#ac-controller
```

```
WS(config-ac)#client-kick H.H.H----->H.H.H is the user's MAC address.
```

Because the client will be automatically reconnected, when the show ac-con client by-ap-name command is run after the user is forced offline, the offline STA is still displayed.

3.7.3 Where is the ap-config file saved on the AC?

It's saved in the ap-config.text file in AC flash.

3.7.4 Does the wireless network support VLAN-Group?

A VLAN-Group contains multiple VLANs. By associating with a VLAN-Group, a WLAN can map to multiple VLANs and VLANs can be flexibly allocated to STAs connected to the WLAN. The VLANs are allocated mainly in the following two modes:

After the STA passes the 802.1x authentication, the authentication server assigns a VLAN for the STA. The STA must be deployed in the 802.1x authentication mode and the authentication mode must be supported by the authentication server.

The server assigns the VLAN for the STA according to the idle status of the address pool.

3.7.5 How to view the wireless terminal type and operating system information on the AC?

Enable ip dhcp snooping and run the following command on AC:

```
ruijie#sh terminal-identify user
```

```
User entry list: 3
```

mac-address	aging-time	terminal-type
68df.ddc7.de5a	--:--	XIAOMI Phone Android 4.2
3859.f98b.658b	--:--	PC Windows 7
a844.8130.c304	--:--	Nokia Phone Windows 8

Note: Due to terminal restrictions, the terminal may not be identified completely correct. When the terminal is connected to the wireless network, a DHCP packet is sent. The device reads the option 60 field in the packet. The field carries the terminal type information. However, not the DHCP packet of all the terminals carries the field, and thus the read success rate is not 100%.

3.7.6 Which of “ap-conf all” and “ap-config name” takes effect first?

The AP configuration under ap-config name takes effect first. If the AP under ap-config name is not configured, the ap-config all configuration takes effect.

3.7.7 How to fix when the device cannot ping the domain name?

Supplement the configuration AC(config)#ip name-server 8.8.8.8, which is used to set the DNS domain name for the device. You can modify the configuration based on the actual environment. Ensure that the AC normally communicates with the extranet.

3.7.8 How to delete an offline AP?

Perform the following operation:

```
Ruijie(config)#no ap-config ap-name1
```

```
Ruijie(config)#no ap-config all ----Delete the ap-config of all the offline APs.
```

Only configurations of offline APs can be deleted.

3.7.9 How to configure the location of a fit AP?

Refer to the following configuration:

```
Ruijie(config)#ap-config 001a.a9bf.ffdc
```

```
Ruijie(config-ap)#location meeting room
```

3.7.10 How to modify the address used by the AC to create the CAPWAP tunnel?

```
Ruijie(config)#ac-controller
```

```
Ruijie(config-ac)#capwap ctrl-ip 2.2.2.2
```

3.7.11 How to modify the SSID of the wireless network?

Go to the WLAN configuration mode:

```
Ruijie(config)#wlan-config 1 ( "1" is the wlan sequence)
```

```
Ruijie(config-wlan)#ssid yy (yy is the new SSID)
```

3.7.12 How to configure the static AP IP address in fit AP mode?

Refer to the command: (when this parameter is modified, a tunnel is re-created.)

(1) Log on to the AP through the Console or Telnet port, and enter the global mode (the password is *apdebug*) to configure the static AP IP address, default route, and AC IP address:

```
Ruijie(config)#acip ipv4 1.1.1.1 // Configure the IP address for the AC.
```

```
Ruijie(config)#apip ipv4 172.16.1.34 255.255.255.0 172.16.1.109
```

(2) After the tunnel between the AP and the AC is created, log on to the AC to configure a static IP address for the AP:

```
Ruijie(config)#ap-config 220e
```

```
Ruijie(config-ap)#acip ipv4 1.1.1.1 ---->Configure the IP address of the AC.
```

```
Ruijie(config-ap)#ip address 172.16.1.34 255.255.255.0 172.16.1.109 ---->Configure the IP address, mask, and gateway for the AP. After configuration, the capwap tunnel will be re-created.
```

The configurations retain even the AP is restarted.

3.7.13 How to disable a radio of the AP?

In fat mode, directly go to this radio and shut it down.

```
Ruijie(config)#interface dot11radio 1/0
```

```
Ruijie(config-if-dot11radio 1/0)#shutdown
```

In fit mode:

```
Ruijie(config)#ap-config ap-name ---->Go to the AP configuration mode
```

```
Ruijie(config-ap)#no enable-radio 1 ---->Disable the radio 1.
```

3.7.14 How to disable automatic adjustment for the RRM channel?

```
Ruijie(config)#advanced 802.11a channel global off
```

```
Ruijie(config)#advanced 802.11b channel global off
```

3.7.15 How to cancel AAA authentication for AC logon when AAA authentication is enabled on the AC?

You can cancel AAA authentication for AC logon by modifying the configurations.

```
Ruijie(config)#aaa new-model
```

```
Ruijie(config)#aaa authentication login no-login none ---->Create an AAA logon authentication list named "no-login" and set the configuration to none (no authentication).
```

```
Ruijie(config)#line con 0
```

```
Ruijie(config-line)#login authentication no-login ---->Apply the no-login to the console line, which indicates that the AAA authentication is not used.
```

```
Ruijie(config-line)#line vty 0 35
```

```
Ruijie(config-line)#login authentication no-login ---->No password is needed for logon through the Telnet port.
```

3.7.16 How to configure switchover of the AC/AP O/E multiplexing interface

1. On AP:

```
Ruijie(config)#interface gigabitEthernet0/1
```

```
Ruijie(config-if-GigabitEthernet 0/1)# media-type baset ---->Enable the electrical interface.
```

```
Ruijie(config-if-GigabitEthernet 0/1)#media-type basex ---->Enable the optical interface.
```

2. On AC:

```
Ruijie(config)#interface gigabitEthernet 0/1
```

```
Ruijie(config-if-GigabitEthernet 0/1)#medium-type copper
```

```
Ruijie(config-if-GigabitEthernet 0/1)#medium-type fiber
```

```
Ruijie(config-if-GigabitEthernet 0/1)#end
```

```
Ruijie#write
```

3.7.17 How to synchronize the AC time to the AP

```
Ruijie(config)# ap-config AP0001 //Enter the specified AP configuration mode.
```

```
Ruijie(config-ap)# timestamp /Configure AP0001 to synchronize the time of the local AC to the AP.
```

3.7.18 How to configure daily timed restart for the AP?

To prevent that the network connection is affected by too large load caused by long-time running of the AP, the daily timed restart can be set for the AP to ensure the network connection quality.

Configure Ruijie-AP1 to restart the AP at 1:00:00 each day on AC:

```
Ruijie(config)#ap-config Ruijie-AP1
```

```
Ruijie(config-ap)#reload at 1:00:00
```

3.7.19 How to close the LED indicator of the AP?

(1) Define a schedule session.

```
AC(config)#schedule session 1
```

```
AC(config)#schedule session 1 time-range 1 period Sun to Sat time 00:00 to 23:59
```

(2) Apply the schedule session on the AP

```
AC(config)#ap-config ap-name
```

```
AC(config-ap)#quiet-mode session 1
```

3.7.20 How to check the number of APs that can be supported by a device?

```
ruijie#sh ac-config
```

```
AC Configuration info:
```

```
max_wtp:32
```

```
sta_limit:1024
```

```
license wtp max:32
```

```
license sta max:1024
```

```
serial auth      :Disable
```

```
password auth    :Disable
```

```
certificate auth :Disable
```

```
Bind AP MAC      :Disable
```

```
AP Priority       :Disable
```

```
supp_psk_cer     :Disable
```

```
ac_name:end
```

```
ac location      :Ruijie_COM
```

3.7.21 How to view the MAC address of the AC?

```
WS6108#sh ac-config
```

AC State info:

```
sta_num          :0
act_wtp          :6
localIpAddr      :1.1.1.1
localIpAddr6     :::
used wtp         :6.0(6 normal 0 half 0 zero)
remain wtp       :42 normal 84 half 634 zero
HW Ver           :1.01
SW Ver           :AC_RGOS 11.1(5)B7, Release(02231014)
Mac address      :5869.6c20.726a
Product ID       :WS6108
NET ID           :9876543210012345
NAS ID           :5869.6c20.726a
```

For VAC:

```
WS6108#show member
```

```
System description      : WS6108
System Mac Address      : 58:69:6C:20:72:6A
```

3.7.22 How to fix when the AP management address is forgotten?

1. Networking Requirements

The administrator forgets the management address of WALL-AP but does not want to modify the device configurations or the factory settings of the device cannot be restored. **This method is also applicable for devices with a Console port but cannot be logged onto through the Console port.**

2. Configuration Tips

1. Execute the packet capture software on a PC to capture packets from the interface of the wired network.
2. Connect the WALL-AP cable to the PC and power on the AP.

3. Configuration Steps

1. Execute the packet capture software (using Wireshark for an example) to capture packets from the wired interface.

(1) Select the interface.

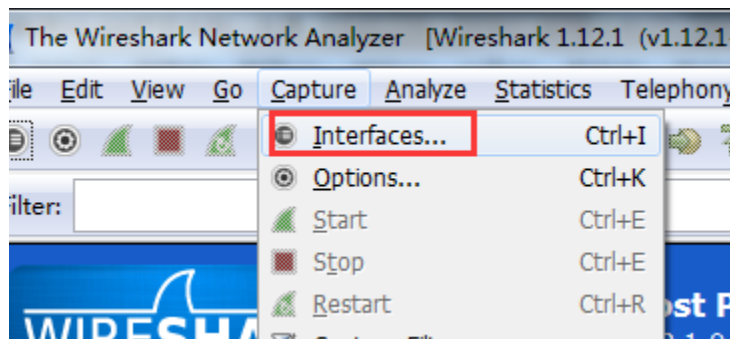

(2) Select the wired interface of the AP and click **Start** to capture the packets.

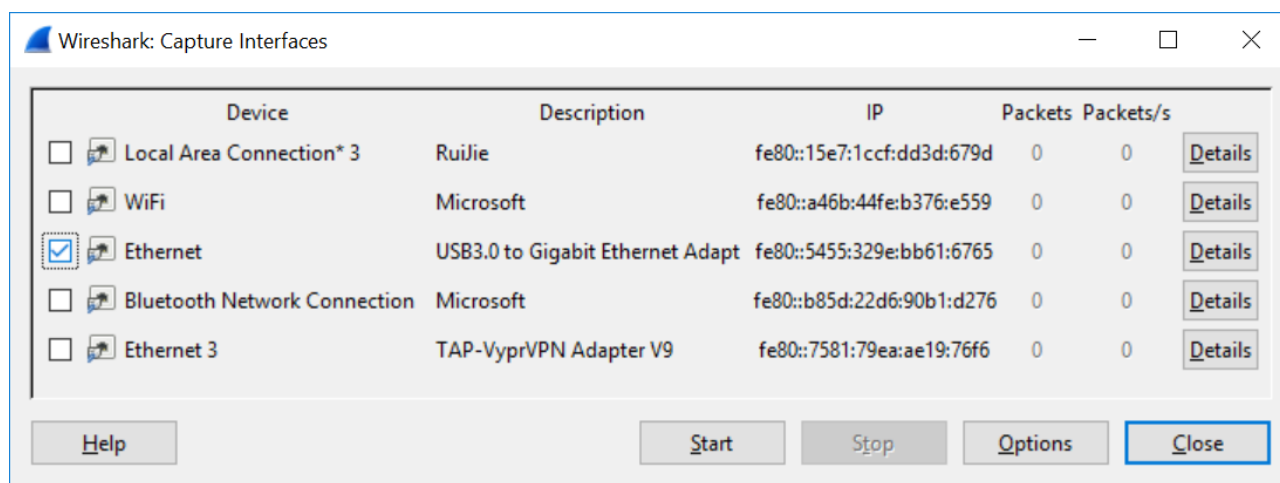

(3) Connect the wired interface of the PC to the AP Ethernet port that is not powered on.

(4) Power on the AP to view packets output by the packet capture software on the PC. Pay attention to the ARP packets.

Because the PC is directly connected to the AP, all the ARP packets except those sent by the PC are ARP packets sent by the AP.

Destination	Protocol	Length	Info
d:6b:9e: Broadcast	ARP	42	who has 192.168.51.1? Tell 192.168.51.54
d:6b:9e: Broadcast	ARP	42	who has 192.168.51.1? Tell 192.168.51.54
00:3a:a4: Broadcast	ARP	64	Gratuitous ARP for 192.168.1.1 (Request) [ETHERNE
00:3a:a4: Broadcast	ARP	64	Gratuitous ARP for 192.168.1.1 (Request) [ETHERNE
d:6b:9e: Broadcast	ARP	42	who has 192.168.51.1? Tell 192.168.51.54
d:6b:9e: Broadcast	ARP	42	who has 192.168.51.1? Tell 192.168.51.54

(5) After getting the AP IP address from the ARP packets, try to log on to the AP through the Telnet port.

(6) The AP may not send the ARP resolution packets. In this case, you can use the LLDP packets to obtain the AP management address. The Management Address in the LLDP packets is the management address of the AP.

(7) If you still cannot log on to the AP, restore the factory settings of WALL-AP, which results in loss of all configurations. You can try to log on to APs with the Console port from a serial port.

It is found that during actual packet capture, the AP often does not send the ARP resolution packets. In this case, you can use the LLDP packets to obtain the AP management address.

1. The following is a packet capture screenshot:

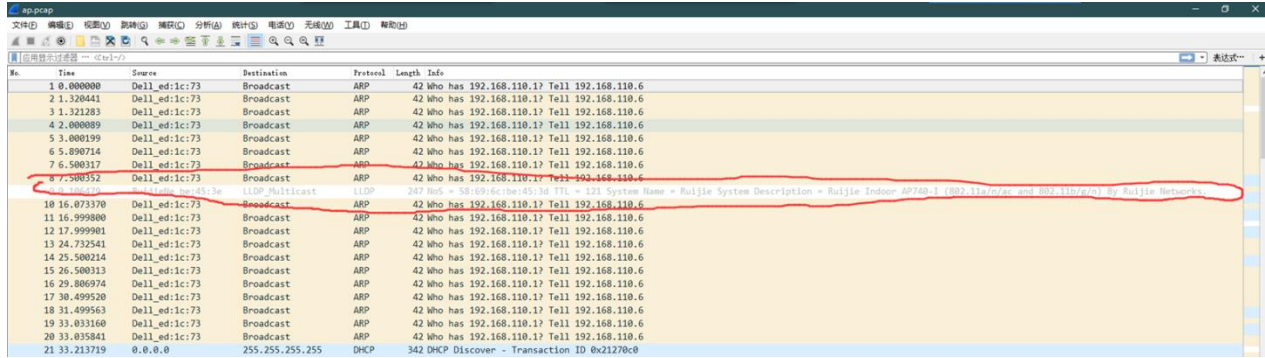

2. Click to open the LLDP packet. The part in the red frame below is the management address of the AP:

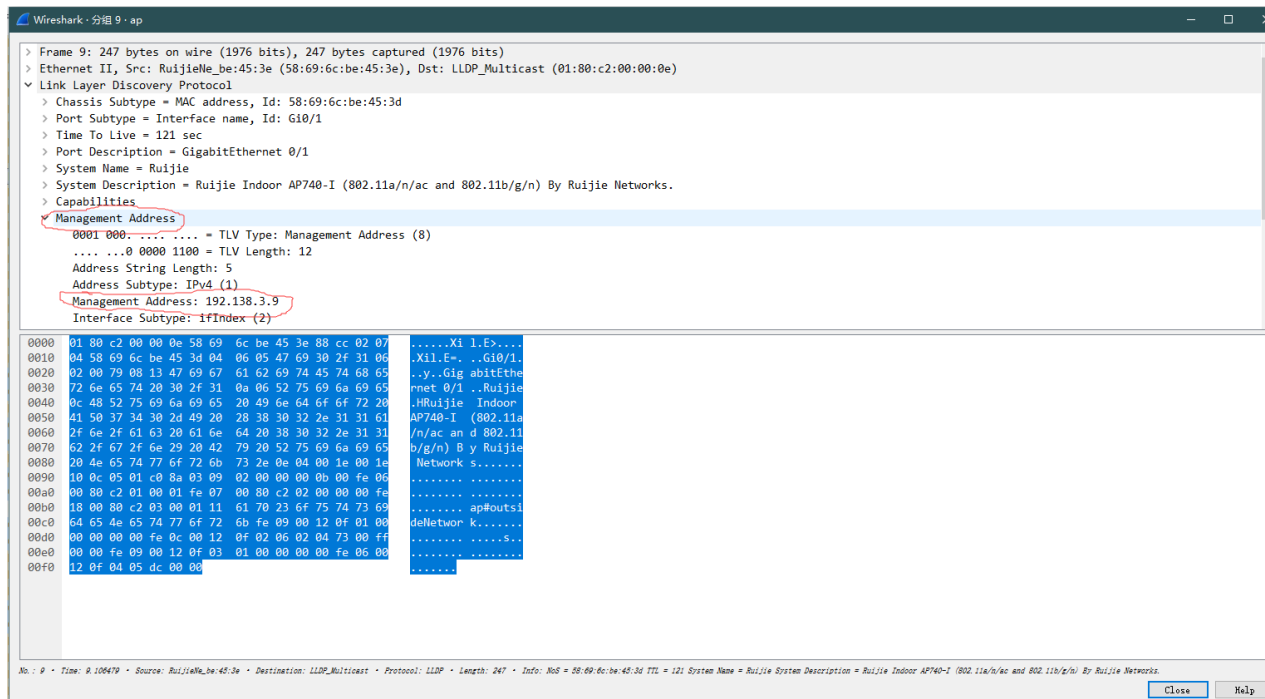

3.7.23 How to fix when the system can output information but cannot be operated during CRT-based logon through the Console port?

1. Symptom

According to the AP320-I users, in case of logon through the Console port, there is information prompted, but no response is returned after Enter is pressed. Besides, no command can be entered.

2. Network Environment

The AP is new and just installed. It is logged onto through CRT.

3. Troubleshooting Steps

- (1) Check whether the CRT or the HyperTerminal is used. If CRT is used, uncheck CTS/RTS.
- (2) If an additional cable is used, confirm whether the driver is installed correctly.
- (3) Change the baud rate. The baud rate for the version 1T8 is 115200 bps.
- (4) Change the console cable and the PC.

4. Solution

Uncheck CTS/RTS.

5. Summary and Precautions

Summary: Other faults caused by the CRT traffic control function.

- (1) You cannot use CRT to log on to the console.
- (2) After CRT-based logon, the operation window is blank, the system outputs no information but the cursor flashes. The system has no response after you press Enter.
- (3) After CRT-based logon, the operation window is blank, the system outputs no information but the cursor flashes. After you press Enter, the cursor moves but the system still outputs no information.
- (4) After CRT-based logon, the system outputs information, but has no response after your press Enter and does not allow you to perform any operation.
- (5) **After HyperTerminal-based logon, the Data Traffic Control in COM attribute settings must be set to None.**

3.7.24 How many APs can different AC Model manage?

Model	Default	Maximum
WS6008	32	224
WS6108	32	320
WS6024	24	24
WS6812	128	1024
WS6816	128	2560 (WALL AP <=4000)
RG-M8600E-WS-ED	128	2560 (WALL AP <=4000)
RG-M18000-WS-ED	128	2560 (WALL AP <=4000)
M6000-WS	32	128

A WALL-AP occupies only 0.5 license. "<=4000" means up to 4,000 WALL-APs are supported.

Run the **show ac-c** command in AC to display license occupation information. The meaning of four, normal, half, and zero is described below.

four: The AP occupies four licenses. Currently, only APs of the model AM5528 and AM5528(ES) occupy four licenses each. APs of the model AM5514 only occupy two licenses each.

normal: An ordinary AP occupies only one license, including AP220-E, AP320-I, and AP520.

half: A WALL-AP occupies only 0.5 license.

zero: The AP occupies no license. The AP is AP(MAP552(SR)) and APD-M.

3.7.25 How to view the number of licenses occupied by different AP model on AC?

AC#show ap-config product

Product ID	Hardware Version	Count	Used Wtp
AM5528	1.00	245	980.0
AP520	1.00	906	906.0
AP630(IDA)	1.50	33	33.0
AP630(IODA)	1.00	83	83.0

3.7.26 How to migrate a wireless AC license to another device (unbinding license)

(1) Upgrade the device version to RGOS 11.1(5)B9 or a later version.

For authentication code:

Run the **AC(config)#no set license activation-key** command to unbind the authorized code. (The activation-key is a 32-bit activation code.)

For authentication file:

Run the **AC#license unbind authorized file name** command to unbind the authorized file to get the verification code.

You can run the **show license unbind-code** or **show apmg debug unbind** command to display the verification code.

Note: after activation code of the unbound license is deleted, the license cannot be installed on the device again.

(2) Submit the device serial number, the license activation code, and verification code on Ruijie authentication system(http://pa.ruijie.com.cn:8001/main_wireless.jsf) to unbind the license on the authorization system. Contact Ruijie TAC to approve the unbinding.

(3) To bind the license again, submit the serial number of the new device and authorization code to register the license. A new activation code is obtained.

(4) Install the new activation code to the new AC.

For More details, please refer to [WLAN License Activation Guide](#):

3.7.27 Can multiple temporary licenses be imported to the same device?

You can apply for a temporary license for an AC three times. The application is automatically reviewed and approved. Only one temporary license of the same specifications can be imported into an AC. The second license overwrites the first.

Multiple temporary licenses of different specifications can coexist in one AC. For example, when two temporary licenses can manage 32 APs are applied for the same AC, only one license can be imported to the AC. When a license can manage 32 APs and a license can management 128 APs are applied for the same AC, both licenses can be imported to the AC.

3.7.28 How to bind a license on VAC

(1) When VAC deployment is not finished yet, the procedure is same to that of normal AC

(2) When VAC deployment is finished, the procedure is basically the same. Bind the corresponding license authorization code to the device according to its serial number.

For authentication code, use **set license** command to bind the authentication code on main AC.

For authentication files, all the authorization files must be imported to the main AC and operated by running the following commands.

AC#license auto-install flash: LIC-WLAN-AP-5120000001765223.lic

The authorization files can be automatically uploaded.

If the authorization file is operated on the standby AC, the message "% Can't execute this command in redundancy slave" is prompted.

(3) **AC#license install** means that the authorization file is only installed in this host.

3.7.29 Will APs go offline immediately if the license is unblind from AC?

No. The AP will not go offline unless it goes offline actively or the AC is restarted. As long as the current AP does not actively go offline and the AC is not restarted, the AP will always be online.

3.7.30 Will online Aps be kicked offline when the licenses are insufficient after temporary authorization expires?

No. APs will not be kicked offline due to deletion of temporary or formal authorization. The system judges whether the licenses are sufficient only when the AP is getting online. APs that go offline after authorization expire cannot go online again.

4 Basic Features

4.1 Fit AP Configuration

4.1.1 CAPWAP

Summarize

With the development of wireless LAN, WLAN technology has been widely used in various fields such as family, enterprise and public places etc. The transmission of wireless frame between access point and wireless terminations in the form of electromagnetic wave instead of wired medium, which makes the wireless terminals movable freely. WLAN technology is the integration of Ethernet and wireless technology and makes wireless terminals easy to access to the wireless local area network. Access point is the middle-transfer-device between wireless terminals and Access Controller in WLAN. When there are plenty of access points in WLAN, how to manage these Aps is key problem in operation.

FAT AP Architecture

In the traditional network architecture, the WTPs completely implement and terminate the 802.11 function so that frames on the wired LAN are 802.3 frames. Each WTP can be independently managed as a separate network entity on the network. The access point in such a network is often called a "Fat AP".

FIT AP Architecture

The thin AP architecture is a hierarchical architecture that involves a WLAN controller that is responsible for configuration, control, and management of several WTPs. The WLAN controller is also known as the Access Controller (AC). The 802.11 function is split between the WTP and the AC. Because the WTPs in this model have a reduced function as compared to the fat AP architecture, they are called "Fit APs."

Fit AP Architecture Advantages

Centralized management

Automatic software upgrade

High security and low interference

Since the distinct advantages of fit AP architecture, it's generally adopted especially in large networks with many APs. The CAPWAP framework is used to define the interface and protocol between an AC and its controlled APs.

Currently, each manufacturer adopts their own private tunnel protocols to exchange messages between AC and AP and this leads to the problem that the AC and AP from different manufacturers cannot communicate with each other.

To solve this problem, IETFCAPWAP working group is set up in 2005 to standardize the tunnel protocols between AC and AP (RFC5415).

2 Terms Explanation

CAPWAP	Control and Provisioning of Wireless Access Points
Local MAC	Local Medium Access Control
Split MAC	Split Medium Access Control
DTLS	Datagram Transport Layer Security

WTP	Wireless Terminal Point
AC	Access Control
AP	Access Point

3 CAPWAP Overview

CAPWAP (Control and Provisioning of Wireless Access Points) is a generic protocol that enables a controller to manage a collection of Wireless Terminal Point (WTP). The CAPWAP protocol is described in RFC 5415 which does not include specific wireless technologies; instead, it relies on a binding specification to extend the technology to a particular wireless technology. The binding specifications for the IEEE 802.11 wireless protocol are defined in RFC5416.

CAPWAP is an application layer protocol over UDP. It uses the Datagram Transport Layer Security (DTLS) encryption mechanism which is standard IETF protocol based on TLS.

CAPWAP Main Functions

To centralize the authentication and policy enforcement functions for a wireless network. The AC may also provide centralized bridging, forwarding and encryption of user traffic.

To enable shifting of the higher-level protocol processing from the WTP. This leaves the time-critical applications of wireless control and access in the WTPs, which are subject to severe cost pressure.

To provide an extensible protocol that is not bound to a specific wireless technology.

The CAPWAP tunnel is divided into:

Control tunnel: to transport the CAPWAP control messages

Data tunnel: to transport the CAPWAP data messages

See the figure below for CAPWAP tunnel:

3.1 Local MAC and Split MAC

In the split MAC mode, all the layer 2 wireless data and management frames will be encapsulated by CAPWAP protocol and exchanged between AC and WTP.

As shown in figure 1, the wireless frames received from the station will be directly encapsulated and forwarded to AC.

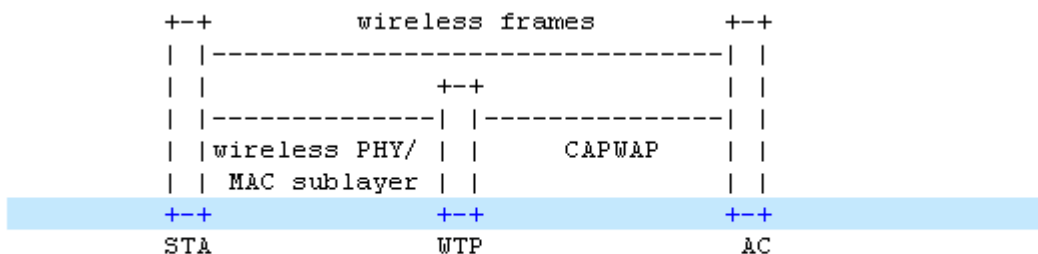

Figure 1: Representative CAPWAP Architecture for Split MAC

In the local MAC mode, the data frames can be forwarded through local bridge or 802.3 frames as shown in figure 2. In this mode, layer 2 management frames is encapsulated to 802.3 frames on WTP and then forwarded to AC.

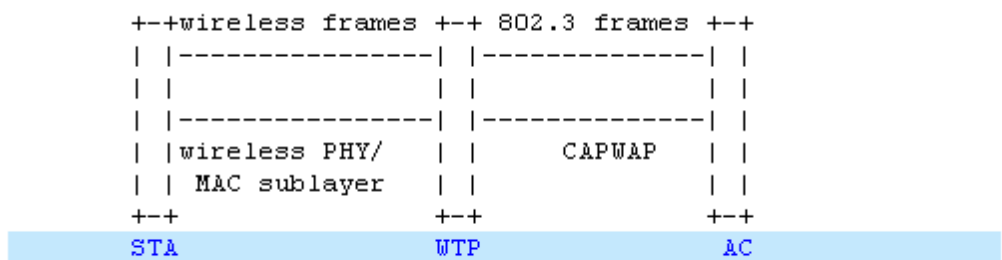

Figure 2: Representative CAPWAP Architecture for Local MAC

The function assignment of Local MAC and Split MAC in CAPWAP protocol is listed in the table below:

Function Description		Local MAC	Split MAC
Function	Distribution Service	AP/AC	AC
	Integration Service	AP	AC
	Beacon Generation	AP	AP
	Probe Response Generation	AP	AP
	Power Mgmt/Packet Buffering	AP	AP
	Fragmentation/Defragmentation	AP	AP/AC
	Assoc/Disassoc/Reassoc	AP/AC	AC
IEEE 802.11 QoS	Classifying	AP	AC
	Scheduling	AP	AP/AC
	Queuing	AP	AP
IEEE 802.11 RSN(WPA2)	IEEE 802.1X/EAP	AC	AC
	RSNA Key Management	AC	AC
	IEEE 802.11	AP	AP/AC
	Encryption/Decryption	AP	AP/AC

3.2 CAPWAP Working Process

Once one WTP is connected to the network, it will enter the state of AC discovery. WTP sends “discovery request” by means of broadcast, multicast or unicast. When unicast is used, WTP needs to obtain the IP address table of AC through DHCP or DNS. The ACs that receive “discovery request” will send “discovery response” to WTP. WTP will then select one among all responding ACs to establish DTLS connection. After DTLS is established successfully, WTP will send “join request” and AC will reply “join response” to confirm. If the firmware’s version on the WTP is overdue, the firmware update process is started and the WTP will download the latest firmware from AC. After firmware updating successfully, the WTP will restart and enter

the discovery process again. If the firmware is the latest, the WTP will download the configuration parameters from AC and then enter the “run” process.

The whole process is illustrated in the figure below:

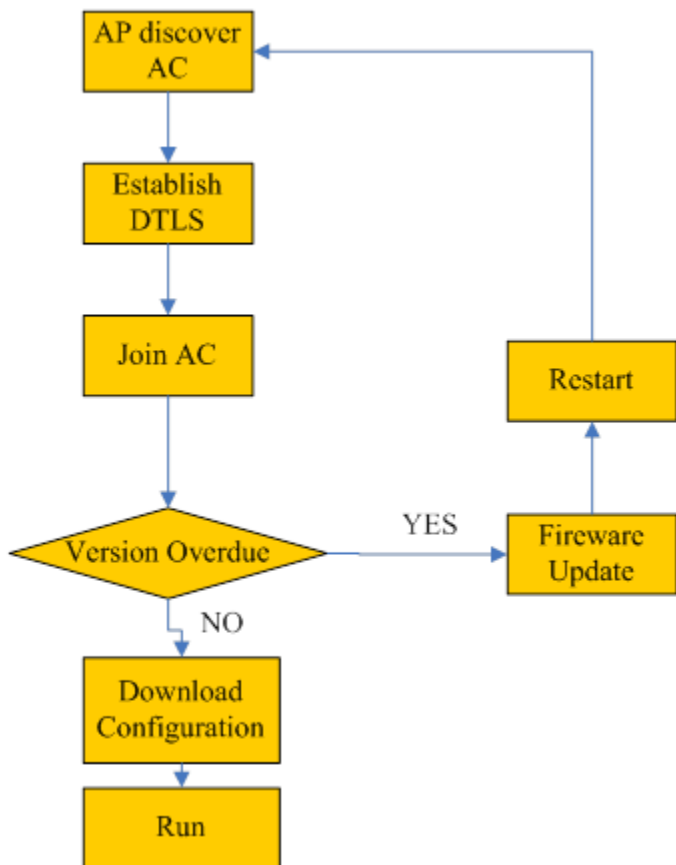

3.3 CAPWAP Session Establishment Process

The ladder diagram below illustrates the CAPWAP session establishment and message exchanges process between a WTP and AC.



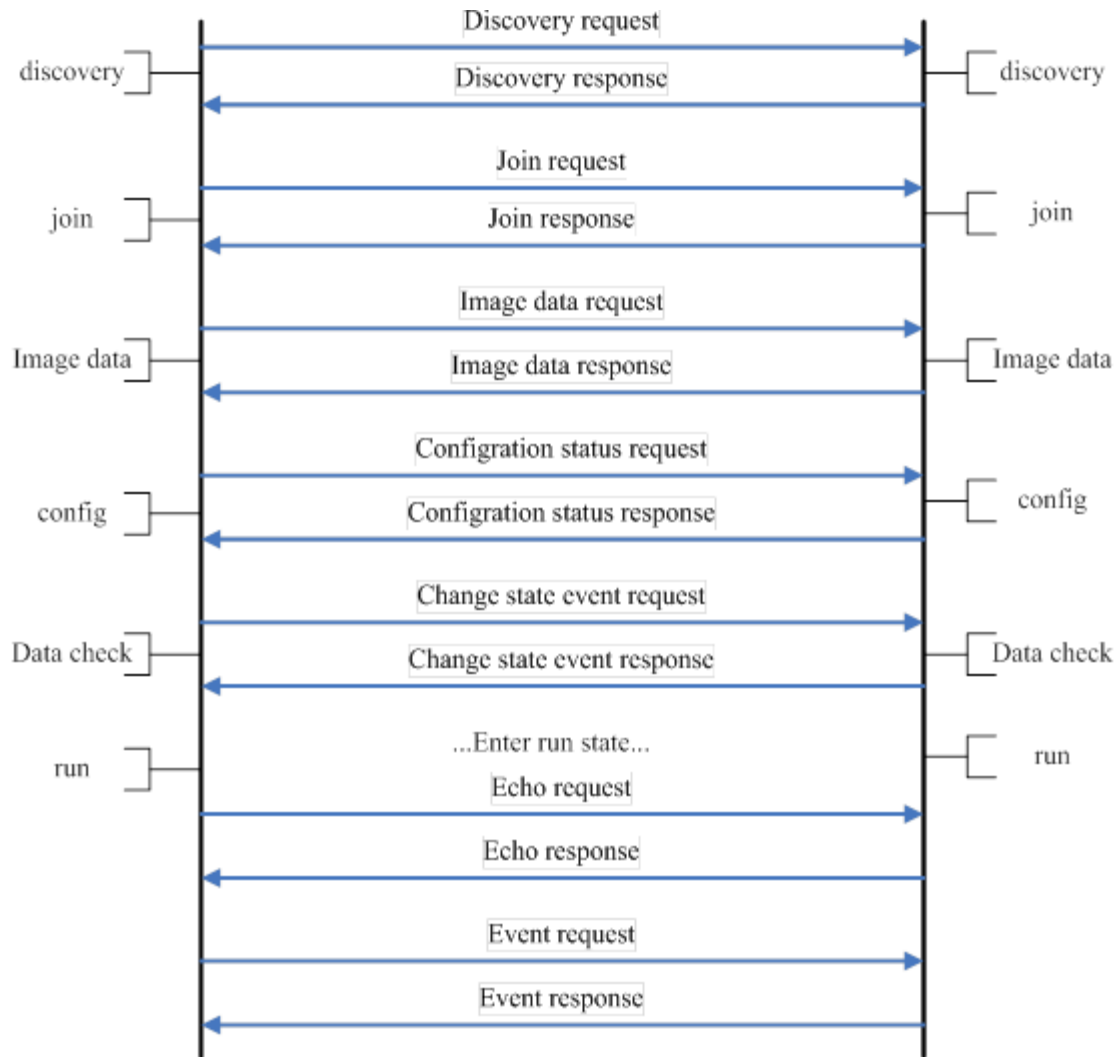

1. WTP sends “discovery request” by means of broadcast, multicast or unicast to discover the available ACs in the network.
2. After receiving the “discovery request” from WTP, AC responds a “Discovery Response” message to WTP to tell the supported service.
3. When the DTLS connection is established, WTP sends the “Join Request” to the AC to request service.
4. AC responds “Join Response” message to inform the WTP that AC can provide service to it.
5. WTP sends “Image data request” message to AC.
6. AC responds “Image data response” message to WTP and WTP can download firmware from AC.
7. WTP sends the current configuration information in “Configuration Status Request” message to AC.
8. AC provides the configuration parameters by responding “Configuration Status Response” message to WTP and WTP request configuration is covered.
9. WTP informs AC that WTP radio state is changed by sending “Change State Event Request” message to AC.
10. AC responds “Change State Event Response” message to WTP.
11. WTP sends “Echo Request” to keep the connection alive when other messages are not exchanged.
12. AC responds “Echo Response” to WTP.

3.4 FIT AP Network Topology

In this topology, SKG1000 (AC) is responsible to manage a number of APs and the communication between AC and AP is realized through CAPWAP tunnels.

As a powerful and high performance AC developed by SKSpurce, SKG1000 can support up to 20000APs and 220K users.

4.1.2 Basic Configuration

Scenario

With fit APs, a network consists of a wired switch, access controllers (ACs) and fit APs. APs are simple wireless access points without management and control functions. The AC manages all APs and sends control policies, which are not configured on each AP, to specified APs, as shown in the following figure. The AC is connected with multiple APs via the wired network, and users only need to configure and manage associated APs with the AC.

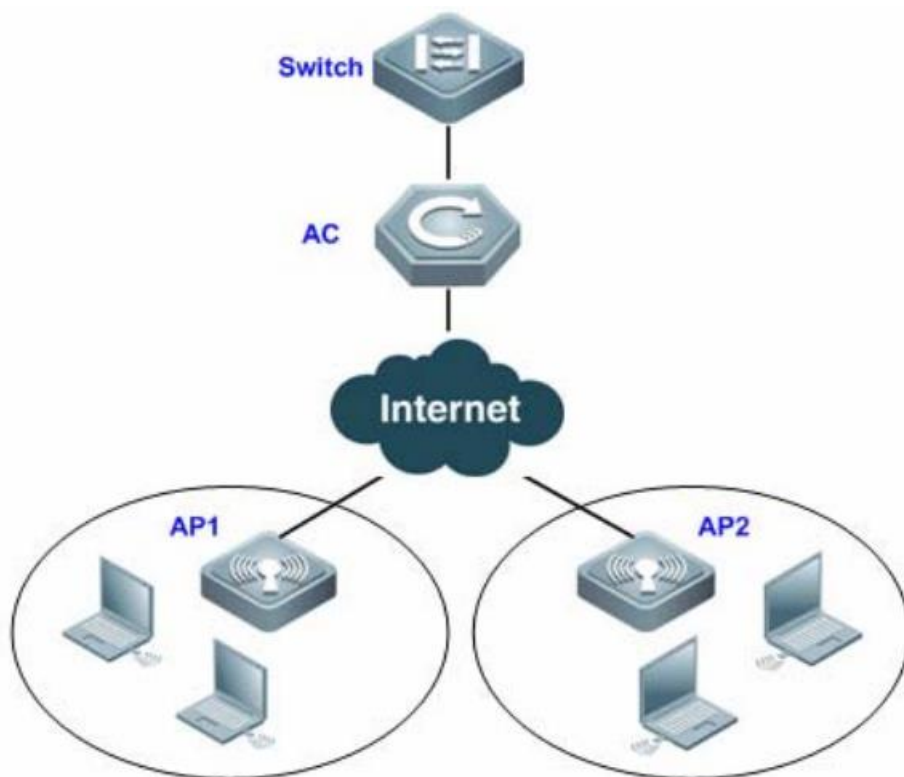

I. Requirements

- AC distribute the configuration to all APs, and manage all Aps
- All APs emit radio signals and connect STA

II. Network Topology

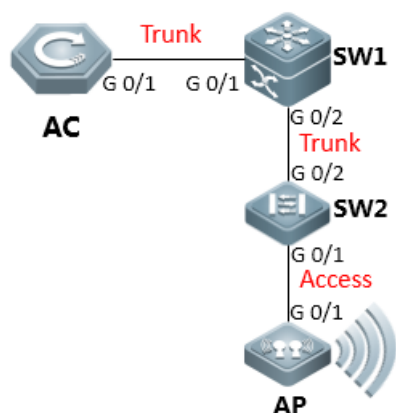

AP	vlan10	192.168.10.0/24
wireless user	vlan 20	192.168.20.0/24
	vlan 30	192.168.30.0/24
AC Connected to SW1	vlan 40	192.168.40.0/24

1. SW1 is configured as ap and wireless user's dhcp server.
2. SW1 is configured as ap and wireless user's gateway.

III. Configuration Tips

- 1) Make sure that AC and AP's firmware should be consistent, using command in CLI "Ruijie>show version"
- 2) Make sure AP is working on fit mode, using command in CLI "Ruijie>show ap-mode " to check. If it shows fat mode, please modify as follow step:

```
Ruijie>enable ----->enter the privilege mode
Ruijie#configure terminal ----->enter the config mode
Ruijie(config)#ap-mode fit ----->modify to fit-mode
Ruijie(config)#end ----->exit the config mode
Ruijie#write ----->save the config
```

IV. Configuration Steps

- 1) Configure AC

Step1: config Vlan, include user vlan and interconnect vlan.

```
Ruijie>enable
Ruijie#configure terminal
Ruijie(config)#vlan 20 ----->user vlan
Ruijie(config-vlan)#name sta
Ruijie(config-vlan)#exit
Ruijie(config)#vlan 30 ----->user vlan
Ruijie(config-vlan)#name sta
Ruijie(config-vlan)#exit
Ruijie(config)#vlan 40 ----->interconnect vlan for ac and sw1
Ruijie(config-vlan)#exit
Ruijie(config)#interface vlan 20 ----->user interface vlan(must config)
Ruijie(config-int-vlan)#ip add 192.168.20.2 255.255.255.0 ----->(optional config), in this case, user gateway is
configured on sw1, so ip address for this
interface can be configured or not.
Ruijie(config)#interface vlan 30 ----->user interface vlan(must config)
```

```
Ruijie(config-int-vlan)#ip add 192.168.30.2 255.255.255.0 ----->(optional config), in this case, user gateway is
configured on sw1, so ip address for this
interface can be configured or not.
Ruijie(config-int-vlan)#exit
```

Step2: Config ssid (multi ssid)

```
Ruijie(config)#wlan-config 1 Ruijie1
Ruijie(config-wlan)#enable-broad-ssid ----->enable broadcast ssid
Ruijie(config-wlan)#exit
Ruijie(config)#wlan-config 2 Ruijie2
Ruijie(config-wlan)#enable-broad-ssid ----->enable broadcast ssid
Ruijie(config-wlan)#exit
```

Step3: Config ap-group

```
Ruijie(config)#ap-group default
Ruijie(config-ap-group)#interface-mapping 1 20 ----->associate wlan-config 1 with user vlan 30
Ruijie(config-ap-group)#interface-mapping 2 30 ----->associate wlan-config 2 with user vlan 30
Ruijie(config-ap-group)#exit
```

Note: If config ap-goup default, then all AP will associate to " ap-group default" group

Step4: Config svi and routing

```
Ruijie(config)#ip route 0.0.0.0 0.0.0.0 192.168.40.1 ----->default routing to sw1
Ruijie(config)#interface vlan 40 ----->interconnect vlan with sw1
Ruijie(config-int-vlan)#ip address 192.168.40.2 255.255.255.0
Ruijie(config-int-vlan)#exit
Ruijie(config)#interface loopback 0
Ruijie(config-int-loopback)#ip address 1.1.1.1 255.255.255.0 ----->AC initialize CAPWAP tunnel setup from loopback
0 interface
Ruijie(config-int-loopback)#exit
Ruijie(config)#interface GigabitEthernet 0/1
Ruijie(config-int-GigabitEthernet 0/1)#switchport mode trunk ----->connect to sw1, trunk port, allow user vlan,
AP vlan, AC-to-SW1 vlan
```

Step5: Save config

```
Ruijie(config-int-GigabitEthernet 0/1)#end
Ruijie#write
```

2) Configure core switch(SW1)

Step1: Vlan config, config user vlan, ap vlan and interconnect vlan

```
Ruijie>enable
Ruijie#configure terminal
```



```

Ruijie(config)#vlan 10 ----->ap vlan
Ruijie(config-vlan)#exit
Ruijie(config)#vlan 20 ----->user vlan
Ruijie(config-vlan)#exit
Ruijie(config)#vlan 30 ----->user vlan
Ruijie(config-vlan)#exit
Ruijie(config)#vlan 40 ----->interconnect vlan with AC
Ruijie(config-vlan)#exit

```

Step2: Config interface and svi

```

Ruijie(config)# interface GigabitEthernet 0/1
Ruijie(config-int-GigabitEthernet 0/1)#switchport mode trunk ----->uplink port, connect to AC, trunk port,allow
user vlan, AP vlan, AC-to-SW1 vlan
Ruijie(config-int-GigabitEthernet 0/1)#exit
Ruijie(config)#interface GigabitEthernet 0/2
Ruijie(config-int-GigabitEthernet 0/2)#switchport mode trunk ----->downlink port, connect to SW2,trunk
port,allow user vlan, AP vlan
Ruijie(config-int-GigabitEthernet 0/2)#exit
Ruijie(config)#interface vlan 10 ----->ap gateway
Ruijie(config-int-vlan)#ip address 192.168.10.1 255.255.255.0
Ruijie(config-int-vlan)#interface vlan 20 ----->sta gateway
Ruijie(config-int-vlan)#ip address 192.168.20.1 255.255.255.0
Ruijie(config-int-vlan)#interface vlan 30 ----->sta gateway
Ruijie(config-int-vlan)#ip address 192.168.30.1 255.255.255.0
Ruijie(config-int-vlan)#interface vlan 40 ----->interconnect with ac
Ruijie(config-int-vlan)#ip address 192.168.40.1 255.255.255.0
Ruijie(config-int-vlan)#exit

```

Step3: Config ip dhcp server

```

Ruijie(config)#service dhcp
Ruijie(config)#ip dhcp pool ap_ruijie ----->create dhcp pool for ap,pool name is ap_ruijie
Ruijie(config-dhcp)#option 138 ip 1.1.1.1 ----->config option 138, assign ac loopback 0 ip address
Ruijie(config-dhcp)#network 192.168.10.0 255.255.255.0 ----->assign these address to ap
Ruijie(config-dhcp)#default-route 192.168.10.1 ----->assign the gateway to ap
Ruijie(config-dhcp)#exit
Ruijie(config)#ip dhcp pool user_ruijie1 ----->create dhcp pool for sta,pool name is user_ruijie
Ruijie(config-dhcp)#network 192.168.20.0 255.255.255.0 ----->assign these address to sta
Ruijie(config-dhcp)#default-route 192.168.20.1 ----->assign the gateway to sta
Ruijie(config-dhcp)#dns-server 8.8.8.8 ----->assign the dns to sta
Ruijie(config-dhcp)#exit
Ruijie(config)#ip dhcp pool user_ruijie2 ----->create dhcp pool for sta,pool name is user_ruijie

```

```
Ruijie(config-dhcp)#network 192.168.30.0 255.255.255.0 ----->assign these address to sta
Ruijie(config-dhcp)#default-route 192.168.30.1 ----->assign the gateway to sta
Ruijie(config-dhcp)#dns-server 8.8.8.8 ----->assign the dns to sta
Ruijie(config-dhcp)#exit
```

//Note: when there is no dhcp pool for AP, You could also excute command to assign acip and apip for ap. configuration example is as follow:

```
Ruijie(config)#acip ipv4 x.x.x.x
Ruijie(config)#apip ipv4 x.x.x.x
```

Step4: Config static routing

```
Ruijie(config)#ip route 1.1.1.1 255.255.255.255 192.168.40.2 ----->config static route, route to AC loopback0
```

Step5: Save configuration

```
Ruijie(config)#exit
Ruijie#write
```

3) Configure access switch (SW2)

Step1: Config vlan, create ap vlan

```
Ruijie>enable
Ruijie#configure terminal
Ruijie(config)#vlan 10
Ruijie(config-vlan)#exit
```

Step2: Config interface

```
Ruijie(config)#interface GigabitEthernet 0/1
Ruijie(config-int-GigabitEthernet 0/1)#switchport access vlan 10 ----->connect to AC, access port, allow ap vlan
Ruijie(config-int-GigabitEthernet 0/1)#exit
Ruijie(config)#interface GigabitEthernet 0/2
Ruijie(config-int-GigabitEthernet 0/2)#switchport mode trunk ----->connect to SW1, trunk port
```

Step3: Save configuration

```
Ruijie(config-int-GigabitEthernet 0/2)#end
Ruijie#write
```

V. Verification

- 1) STA connect to the ssid
- 2) Check ap config on AC

```
Ruijie#show ap-config summary
===== show ap status =====
Radio: E = enabled, D = disabled, N = Not exist
```

```

Current Sta number
Channel: * = Global
Power Level = Percent
Online AP number: 1
Offline AP number: 0
AP Name                IP Address      Mac Address     Radio 1         Radio 2
Up/Off time   State
-----
1414.4b13.c248        192.168.10.2   1414.4b13.c248 E   1       6* 100 E   0       153*
100   0:09:04:28 Run

```

3) Check sta information on AC

```

Ruijie#show ac-config client by-ap-name
===== show sta status =====
AP   : ap name/radio id
Status: Speed/Power Save/Work Mode, E = enable power save, D = disable power save

Total Sta Num: 1
STA MAC      IPV4 Address   AP                               Wlan Vlan Status   Asso Auth
Net Auth   Up time
-----
6809.27b0.169f 192.168.20.2  1414.4b13.c248/1              1   20  58.0M/D/bn   WPA2_PSK
0:00:11:21
8ca9.829a.b1ea 192.168.30.2  1414.4b13.c248/1              2   30  58.0M/D/bn   WPA2_PSK
0:03:22:31

```

What if it don't work?

Use the following steps while aps cannot go online:

- 1) Confirm whether the versions of AC and AP are consistent, if not, recommend to upgrade first, the latest firmware could be download from our official website: <http://www.ruijienetworks.com/service/download.aspx>

- 2) Confirm whether the AP obtain ip address and ACIP successfully or not with command below:

```

AP# Show ip int br
AP#show capwap client sta

```

- 3) Confirm the connectivity between AP and ACIP, if disconnected, check the ip routes on AP:

```

AP# show ip route

```

If there is not ip route pointing to ACIP, add an ip route,examples are as follows

```
AP(config)# ip route 1.1.1.1 255.255.255.0 192.168.1.2
```

4) Confirm whether the license is not enough.

Examples are as follows:

```
WS5302#sh ac-config
AC Configuration info:
max_wtp          :32 // configure wtp limit on ac-con mode to limit the AP number.
sta_limit        :1024
license wtp max :32 //ap numbers can be supported on ac.
license sta max :1024
serial auth      :Disable
password auth    :Disable
certificate auth :Disable
supp_psk_cer     :Disable
r_mac            :Enable
da_dtls          :Disable
ac_name          :Ac_001aa917151c
udp_lite         :UDP
ECN_Sup          :Disable
mtu              :1500
ap_sw_ver        :
ac location      :Ac_COM
ac_ipv4_num      :0
ac_namewp_num    :0

AC State info:
sta_num          :0
act_wtp          :1

WS5302#show license //check the license
Serial Number    : 9071FH4280024

No. Activation Key          AP Number
-----
-----

Total 32 access points are supported.
WS5302#show ap-config summary
===== show ap status =====
Radio: E = enabled, D = disabled, N = Not exist
      Current Sta number
      Channel: * = Global
```

Power Level = Percent

Online AP number: 1 //online AP number

Offline AP number: 0

AP Name	IP Address	Mac Address	Radio 1	Radio 2
Up/Off time	State			
001a.a94e.d529	192.168.100.3	001a.a94e.d529 E	0	11* 100 E 0 157*
100	0:03:09:17 Run			

- 5) If the AP still could not go online successfully after checking the information above, collect the info with the following command list and submit a case to our case portal http://case.ruijienetworks.com/login_page.php for further checking:

1) collect info on AC:

```
show version
show running
show ac-config
show license
show ap-config summary
show capwap sta
show cpu
show memory
show ip route
show ip interface brief
```

2)Collect info on AP:

```
show version
show ap-mode
show capwap sta
show ip route
show log
show ap-statistic aclist (confirm whether ap obtains option 138 address)
show capwap client state (11.x)
```

4.1.3 AC Directly Connect to AP

I. Requirements

- 1) AC connect to AP directly
- 2) This scene is usually used in the lab in usual.

II. Network Topology

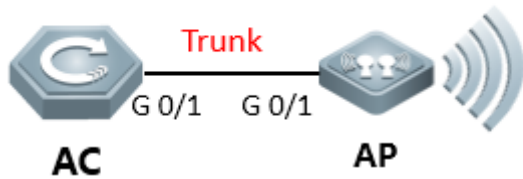

AC loopback 0 : 1.1.1.1
 AP vlan : vlan1 172.16.1.0/24 gateway 172.16.1.1
 STA vlan : vlan2 172.16.2.0/24 gateway 172.16.2.1

III. Configuration Tips

- 1) Make sure that AC and AP's firmware should be consistent, using command in CLI "Ruijie>show version"
- 2) Make sure AP is working on fit mode, using command in CLI "Ruijie>show ap-mode " to check. If it shows fat mode, please modify as follow step:

```
Ruijie>enable          ----->enter the privilege mode
Ruijie#configure terminal ----->enter the config mode
Ruijie(config)#ap-mode fit ----->modify to fit-mode
Ruijie(config)#end    ----->exit the config mode
Ruijie#write          ----->save the config
```

IV. Configuration Steps

Step1: config vlan, create user vlan and ap vlan

```
Ruijie>enable
Ruijie#configure terminal
Ruijie(config)#vlan 1
Ruijie(config-vlan)#exit
Ruijie(config)#vlan 2
Ruijie(config-vlan)#exit
```

Step2: config AP, STA gateway and loopback 0

```
Ruijie(config)#interface vlan 1 ----->ap gateway
Ruijie(config-int-vlan)#ip address 172.16.1.1 255.255.255.0
Ruijie(config-int-vlan)#exit
Ruijie(config)#interface vlan 2 ----->sta gateway
Ruijie(config-int-vlan)#ip address 172.16.2.1 255.255.255.0
Ruijie(config-int-vlan)#exit
Ruijie(config)#interface loopback 0
Ruijie(config-int-loopback)#ip address 1.1.1.1 255.255.255.0
Ruijie(config-int-loopback)#exit
```

Step3: config SSID

```

config wlan-config
Ruijie(config)#wlan-config 1 Ruijie-test ----->config ssid named Ruijie-test
Ruijie(config-wlan)#enable-broad-ssid ----->enable broadcast ssid
Ruijie(config-wlan)#exit
config ap-group
Ruijie(config)#ap-group default
Ruijie(config-ap-group)#interface-mapping 1 2 ----->associate with wlan-config 1 and vlan2
Ruijie(config-ap-group)#exit

```

Step4: config AC interface

```

Ruijie(config-int-loopback)#interface GigabitEthernet 0/1
Ruijie(config-int-GigabitEthernet 0/1)#switchport access vlan 1 ----->connect to ap, allow ap vlan

```

Step5: config ip dhcp server for AP

```

Ruijie(config)#service dhcp
Ruijie(config)#ip dhcp pool ap_ruijie ----->config dhcp pool, named ap_ruijie
Ruijie(config-dhcp)#option 138 ip 1.1.1.1
Ruijie(config-dhcp)#network 172.16.1.0 255.255.255.0 ----->assign the address to ap
Ruijie(config-dhcp)#default-route 172.16.1.1 ----->assign the gateway to ap
Ruijie(config-dhcp)#exit

```

Note: When there is no dhcp for AP, you could also excute command to assign acip and apip for ap. configuration example is as follow:

```

Ruijie(config)#acip ipv4 x.x.x.x
Ruijie(config)#apip ipv4 x.x.x.x

```

Step6: config ip dhcp server for STA

```

Ruijie(config)#ip dhcp pool user_ruijie ----->config dhcp pool, named user_ruijie
Ruijie(config-dhcp)#network 172.16.2.0 255.255.255.0 ----->assign the address to STA
Ruijie(config-dhcp)#default-route 172.16.2.1 ----->assign the gateway to STA
Ruijie(config-dhcp)#dns-server 8.8.8.8 ----->assign the dns to STA
Ruijie(config-dhcp)#exit

```

Step7: save configuration

```

Ruijie(config)#exit
Ruijie#write

```

V. Verification

- 1) STA connect to the ssid.

2) Check ap config on AC

```
Ruijie#show ap-config summary
===== show ap status =====
Radio: E = enabled, D = disabled, N = Not exist
  Current Sta number
  Channel: * = Global
  Power Level = Percent
Online AP number: 1
Offline AP number: 0

AP Name                               IP Address   Mac Address   Radio 1      Radio 2
Up/Off time   State
-----
  1414.4b13.c248           172.16.1.2   1414.4b13.c248 E    1      6* 100 E    0
153* 100   0:06:03:00 Run
```

3) Check sta information on AC

```
Ruijie#show ac-config client by-ap-name
===== show sta status =====
AP   : ap name/radio id
Status: Speed/Power Save/Work Mode, E = enable power save, D = disable power save

Total Sta Num: 1
STA MAC      IPV4 Address   AP                               Wlan Vlan Status   Asso
Auth Net Auth  Up time
-----
6809.27b0.169f 172.16.2.2    1414.4b13.c248/1              1      2   30  0.0M/D/bn
WPA2_PSK      0:00:01:01
```

Note: Recommend upgrade the AP&AC to the latest and more stable version, to avoid the compatibility issues

4.1.4 Wall AP Front Port VLAN Assignment

I. Requirements

Assign the front ports of AP110-W & AP120-W to different vlan

II. Network Topology

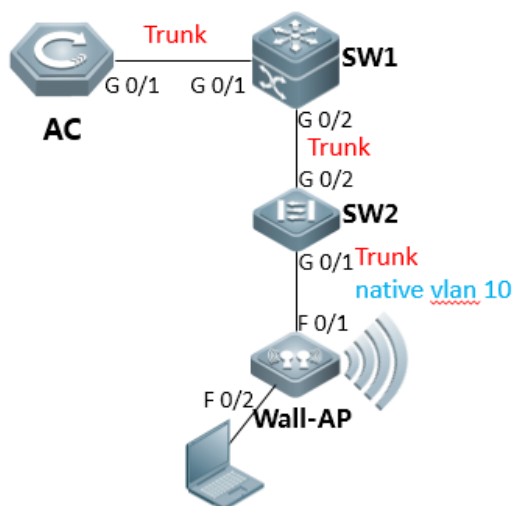

Wall-AP	vlan10	192.168.10.0/24
wireless user	vlan 20	192.168.20.0/24
AC connect to sw1	vlan 30	192.168.30.0/24
Wall-AP fa0/2	vlan100	

1.SW1 is configured as ap and wireless user's dhcp server
 2.SW1 is configured as user and ac gateway

III. Configuration Tips

- 1) Make sure that AC and AP's firmware should be consistent, using command in CLI "Ruijie>show version"
- 2) Make sure AP is working on fit mode, using command in CLI "Ruijie>show ap-mode " to check. If it shows fat mode, please modify as follow step:

```
Ruijie>enable ----->enter the privilege mode
Ruijie#configure terminal ----->enter the config mode
Ruijie(config)#ap-mode fit ----->modify to fit-mode
Ruijie(config)#end ----->exit the config mode
Ruijie#write ----->save the config
```

Note: If the version of AP is earlier than B8, you should execute command "no bridge-l2-isolation" on global mode in case the PC can not access to the network

```
Ruijie(config)#no bridge-l2-isolation
```

IV. Configuration Steps

- 1) AC configuration

Step1: configuring Vlan, include user vlan and interconnect vlan.

```
Ruijie>enable
Ruijie#configure terminal
Ruijie(config)#vlan 20 ----->user vlan
Ruijie(config-vlan)#name sta
Ruijie(config-vlan)#exit
Ruijie(config)#vlan 30 ----->interconnect vlan for ac and sw1
Ruijie(config-vlan)#exit
Ruijie(config)#interface vlan 20 ----->user interface vlan(must config)
```

```
Ruijie(config-int-vlan)#ip add 192.168.20.2 255.255.255.0 ----->(optional config), in this case, user gateway is
configured on sw1, so ip address for this interface can be configured or not.
Ruijie(config-int-vlan)#exit
```

Step2: Configuring ssid

```
Ruijie(config)#wlan-config 1 Ruijie
Ruijie(config-wlan)#enable-broad-ssid ----->enable broadcast ssid
Ruijie(config-wlan)#exit
```

Step3: Configuring ag-group

```
Ruijie(config)#ap-group b8fd.3200.3aa3 ----->enter ap-group with ap's mac-address
Ruijie(config-ap-group)#interface-mapping 1 20 ----->associate wlan-config id with vlan
Ruijie(config)#ap-config ap120-w
Ruijie(config-ap)#ap-group b8fd.3200.3aa3
Ruijie(config-ap)#wired-vlan 100 port 1 ----->assign fa0/2 to vlan 100
Ruijie(config-ap)#exit
```

Note: If config ag-goup default, then all AP will associate to "ap-group default" group

Step4: Configuring svi and routing

```
Ruijie(config)#ip route 0.0.0.0 0.0.0.0 192.168.30.1 ----->default routing to sw1
Ruijie(config)#interface vlan 30 ----->interconnect vlan with sw1
Ruijie(config-int-vlan)#ip address 192.168.30.2 255.255.255.0
Ruijie(config-int-vlan)#exit
Ruijie(config)#interface loopback 0
Ruijie(config-int-loopback)#ip address 1.1.1.1 255.255.255.0 ----->AC initialize CAPWAP tunnel setup from
loopback 0 interface
Ruijie(config-int-loopback)#exit
Ruijie(config)#interface GigabitEthernet 0/1
Ruijie(config-int-GigabitEthernet 0/1)#switchport mode trunk ----->connect to sw1, trunk port, allow user
vlan, AP vlan, AC-to-SW1 vlan
```

Step5: Save configurations

```
Ruijie(config-int-GigabitEthernet 0/1)#end
Ruijie#write
```

2) Config core switch (SW1)

Step1: Configuring user vlan, ap vlan and interconnect vlan

```
Ruijie>enable
Ruijie#configure terminal
Ruijie(config)#vlan 10 ----->ap vlan
Ruijie(config-vlan)#exit
```

```
Ruijie(config)#vlan 20      ----->user vlan
Ruijie(config-vlan)#exit
Ruijie(config)#vlan 30    ----->interconnect vlan with AC
Ruijie(config-vlan)#exit
```

Step2: Configuring interfaces and svi

```
Ruijie(config)# interface GigabitEthernet 0/1
Ruijie(config-int-GigabitEthernet 0/1)#switchport mode trunk      ----->uplink port, connect to AC, trunk
port,allow user vlan、 AP vlan、 AC-to-SW1 vlan
Ruijie(config-int-GigabitEthernet 0/1)#exit
Ruijie(config)#interface GigabitEthernet 0/2
Ruijie(config-int-GigabitEthernet 0/2)#switchport mode trunk      ----->downlink port, connect to SW2,trunk
port,allow user vlan、 AP vlan
Ruijie(config-int-GigabitEthernet 0/2)#exit
Ruijie(config)#interface vlan 10  ----->ap gateway
Ruijie(config-int-vlan)#ip address 192.168.10.1 255.255.255.0
Ruijie(config-int-vlan)#interface vlan 20      ----->wireless user gateway
Ruijie(config-int-vlan)#ip address 192.168.20.1 255.255.255.0
Ruijie(config-int-vlan)#interface vlan 30      ----->interconnect with ac
Ruijie(config-int-vlan)#ip address 192.168.30.1 255.255.255.0
Ruijie(config-int-vlan)#interface vlan 100     ----->gateway for ap120-w front port fa0/2
Ruijie(config-int-vlan)#ip address 192.168.100.1 255.255.255.0
Ruijie(config-int-vlan)#exit
```

Step3: Conifguring ip dhcp server

```
Ruijie(config)#service dhcp
Ruijie(config)#ip dhcp pool ap_ruijie  ----->create dhcp pool for ap,pool name is ap_ruijie
Ruijie(config-dhcp)#option 138 ip 1.1.1.1  ----->config option 138, assign ac loopaback 0 ip address
Ruijie(config-dhcp)#network 192.168.10.0 255.255.255.0  ----->assign these address to ap
Ruijie(config-dhcp)#default-route 192.168.10.1  ----->assign the gateway to ap
Ruijie(config-dhcp)#exit
Ruijie(config)#ip dhcp pool user_ruijie  ----->create dhcp pool for sta,pool name is user_ruijie
Ruijie(config-dhcp)#network 192.168.20.0 255.255.255.0  ----->assign these address to sta
Ruijie(config-dhcp)#default-route 192.168.20.1  ----->assign the gateway to sta
Ruijie(config-dhcp)#dns-server 8.8.8.8  ----->assign the dns to sta
Ruijie(config-dhcp)#exit
```

Step4: Configuring static routing

```
Ruijie(config)#ip route 1.1.1.1 255.255.255.255 192.168.30.2  ----->config static route, route to AC loopback0
```

Step5: Save configuration

```
Ruijie(config)#exit
Ruijie#write
```

3) Configuring access switch (SW2)

Step1: Configuring vlan, create ap vlan

```
Ruijie>enable
Ruijie#configure terminal
Ruijie(config)#vlan 10
Ruijie(config-vlan)#exit
```

Step2: Configuring interface

```
Ruijie(config)#interface GigabitEthernet 0/1          ----->connect to AP120-W
Ruijie(config-int-GigabitEthernet 0/1)#switchport mode trunk
Ruijie(config-int-GigabitEthernet 0/1)#switchport trunk native vlan 10    ---->config ap vlan as native vlan
Ruijie(config-int-GigabitEthernet 0/1)#exit
Ruijie(config)#interface GigabitEthernet 0/2
Ruijie(config-int-GigabitEthernet 0/2)#switchport mode trunk          ----->connect to SW1, trunk port
```

Step3: Save configuration

```
Ruijie(config-int-GigabitEthernet 0/2)#end
Ruijie#write
```

V. Verification

1) login ap120-w, look into the interface configuration, it shows as follow:

```
interface FastEthernet 0/1.100
  encapsulation dot1Q 100
!
interface FastEthernet 0/2
  encapsulation dot1Q 100
```

4.1.5 CAPWAP tunnel is established via NAT

I. Requirements

- 1) AC and AP located in different site
- 2) The CAPWAP tunnel is established through NAT

II. Network Topology

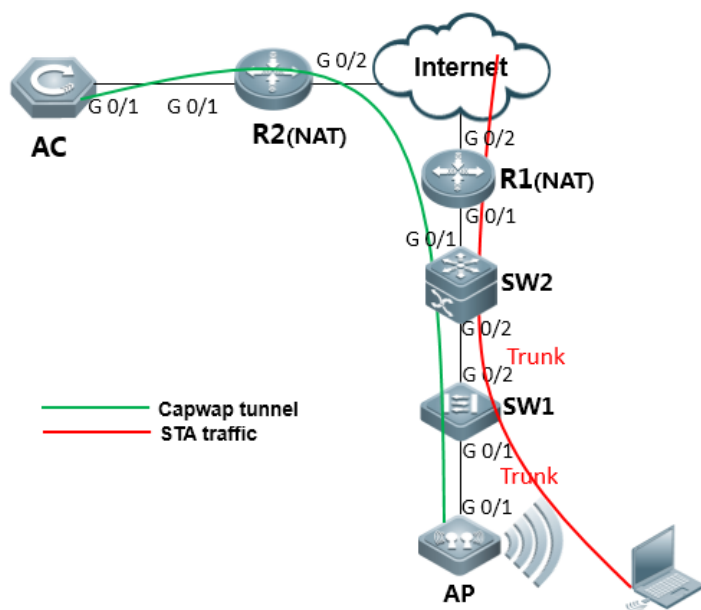

Vlan1 : AC interconnect vlan with R2
svi1 ip address : 192.168.1.0/24

Vlan 10 : interconnect vlan with R1
svi10 ip address : 192.168.10.0/24

Vlan 100 : AP vlan, gateway is configured in SW2
svi100 ip address : 192.168.100.0/24

Vlan 200 : STA vlan, gateway is configured in SW2
svi200 ip address : 192.168.200.0/24

R2 gi0/2 ip address : 192.168.51.97

III. Configuration Tips

- 1) Make sure that AC and AP's firmware should be consistent, using command in CLI "Ruijie>show version"
- 2) Make sure AP is working on fit mode, using command in CLI "Ruijie>show ap-mode " to check. If it shows fat mode, please modify as follow step:

```
Ruijie>enable          ----->enter the privilege mode
Ruijie#configure terminal ----->enter the config mode
Ruijie(config)#ap-mode fit ----->change to fit-mode
Ruijie(config)#end     ----->exit the config mode
Ruijie#write           ----->save the config
```

- 3) configuration guide summarize:

- a. On AC site, configure AC to make sure it can connect to Internet;
- b. Map AC's loopback0 ip into public ip, so that AP could establish capwap tunnel with AC by using public ip;
- c. On AP site, translate the AP IP and User IP into public ip, so that AP could establish capwap tunnel with AC by using public ip, also user could access to internet resource.

IV. Configuration Steps

1) AC

Step1: configure vlan

```
Ruijie>enable
Ruijie#configure terminal
Ruijie(config)#vlan 1 ----->the vlan using for AC interconnect with uplink device
Ruijie(config-vlan)#exit
Ruijie(config)#vlan 200 ----->wireless user vlan
```

```
Ruijie(config-vlan)#
```

Step2: configure svi.

```
Ruijie(config)#interface vlan 200 ----->sta svi ( must config)
Ruijie(config-int-vlan)#exit
```

Step3: configure wlan-config, create ssid.

```
Ruijie(config)#wlan-config 1 NAT ----->wlan-config, id=1,SSID named NAT
Ruijie(config-wlan)#enable-broad-ssid ----->enable broadcast ssid
Ruijie(config-wlan)#tunnel local ----->enable local forwarding,recommend config under NAT scene
Ruijie(config-wlan)#exit
```

Step4: configure ap-group, associate wlan-config id with vlan.

```
Ruijie(config)#ap-group default
Ruijie(config-ap-group)#interface-mapping 1 200 ----->"1"implied wlan-config,"200"implied sta vlan
Ruijie(config-ap-group)#exit
```

Step5: configure ip address of ac uplink port and loopback 0

```
Ruijie(config)#ip route 0.0.0.0 0.0.0.0 192.168.1.254 ----->default route,192.168.1.254 is address of uplink
device
Ruijie(config)#interface vlan 1 ----->config svi, layer3 communicate with uplink device
Ruijie(config-int-vlan)#ip address 192.168.1.253 255.255.255.0
Ruijie(config-int-vlan)#interface loopback 0 ----->config loopback0, using for capwap tunnel establish
Ruijie(config-int-loopback)#ip address 1.1.1.1 255.255.255.255 ----->1.1.1.1 should be translate to a public ip
address on egress router
Ruijie(config-int-loopback)#interface GigabitEthernet 0/1
Ruijie(config-int-GigabitEthernet 0/1)#switchport mode trunk ----->connect to uplink device
```

Step6: Save changes

```
Ruijie(config-int-GigabitEthernet 0/1)#end
Ruijie#write
```

Other equipment of AC site

Configure the route to make sure AC can communicate with internet. AC loopback0 address could be forwarded (using NAT) on egress router.

Configuration guide:

- a. Correctly config routing、vlan、 interface and so on, each equipment could communicate with each other;
- b. Egress router config NAT, translate udp port 5246 & 5247 of ac loopback 0 address (capwap address) into public port, so that AP can establish capwap tunnel with AC successfully

2) SW1 (access switch, on AP site)

```

Ruijie>enable
Ruijie#configure terminal
Ruijie(config)#vlan 100 ----->config AP vlan
Ruijie(config-vlan)#vlan 200 ----->config sta vlan
Ruijie(config)#interface gigabitEthernet 0/1 ----->connect to ap
Ruijie(config-int-GigabitEthernet 0/1)#poe enable ----->enable poe (optional config, should be poe switch)
Ruijie(config-GigabitEthernet 0/1)#switchport mode trunk ----->trunk port,transmit ap vlan and sta vlan
Ruijie(config-GigabitEthernet 0/1)#switchport trunk native vlan 100 ----->config ap vlan as native vlan
Ruijie(config-GigabitEthernet 0/1)#interface gigabitEthernet 0/2 ----->connect to core-switch
Ruijie(config-GigabitEthernet 0/2)#switchport mode trunk ----->trunk port,transmit ap vlan and sta vlan
Ruijie(config-int-GigabitEthernet 0/2)#end
Ruijie#write

```

3) SW2 (core switch, on AP site)

Step1: config vlan, include sta vlan, interconnect vlan with egress router, ap vlan

```

Ruijie>enable
Ruijie#configure terminal
Ruijie(config)#vlan 10
Ruijie(config-vlan)#exit
Ruijie(config)#vlan 100 ----->ap vlan
Ruijie(config-vlan)#exit
Ruijie(config)#vlan 200 ----->sta vlan
Ruijie(config-vlan)#exit

```

Step2: config svi

```

Ruijie(config)#interface VLAN 10 ----->interconnect address with egress router
Ruijie(config-int-vlan)#ip address 192.168.10.254 255.255.255.0
Ruijie(config-int-vlan)#exit
Ruijie(config)#interface vlan 100 ----->AP gateway
Ruijie(config-int-vlan)#ip address 192.168.100.254 255.255.255.0
Ruijie(config-int-vlan)#exit
Ruijie(config)#interface vlan 200 ----->user gateway
Ruijie(config-int-vlan)#ip address 192.168.200.254 255.255.255.0
Ruijie(config-int-vlan)#exit

```

Step3: config interface

```

Ruijie(config)# interface GigabitEthernet 0/1 ----->connect to egress router
Ruijie(config-int-GigabitEthernet 0/1)#switchport access vlan 10
Ruijie(config-int-GigabitEthernet 0/1)#interface GigabitEthernet 0/2

```

```
Ruijie(config-int-GigabitEthernet 0/2)#switchport mode trunk ----->connect to sw1,transmit ap vlan and sta
vlan
Ruijie(config-int-GigabitEthernet 0/2)#exit
```

Step4: config dhcp service, assign ip address to AP

```
Ruijie(config)#service dhcp ----->enable dhcp service
Ruijie(config)#ip dhcp pool AP_vlan ----->enable dhcp pool with name AP_vlan
Ruijie(dhcp-config)# option 138 ip 192.168.51.97 ----assign the capwap tunnel address, which is public address
of AC loopback0
Ruijie(dhcp-config)# network 192.168.100.0 255.255.255.0 ----->assign the ip address to AP
Ruijie(dhcp-config)# default-router 192.168.100.254 ----->assign the gateway to AP
Ruijie(dhcp-config)#exit
```

Step5: config dhcp service, assign ip address to STA

```
Ruijie(config)#ip dhcp pool user_ruijie ----->enable dhcp pool with name user_ruijie
Ruijie(config-dhcp)#network 192.168.200.0 255.255.255.0 ----->assign the ip address to STA
Ruijie(config-dhcp)#default-route 192.168.200.254 ----->assign the gateway to STA
Ruijie(config-dhcp)#dns-server 218.85.157.99 218.85.152.99 ----->assign the dns to STA
Ruijie(config-dhcp)#exit
```

Step6: config routing

```
Ruijie(config)#ip route 0.0.0.0 0.0.0.0 192.168.10.1 ----->config static routing,route to egress router.
```

Step7: save routing

```
Ruijie(config)#exit
Ruijie#write
```

4) Configure R1 (Egress router on AP site)

- configure routing, include default routing、static routing for AP and STA.
- configure NAT, translate AP address into public address and route to R2 (egress router on AC site);translate STA address into public address and could connect to internet.

V. Verification

1) STA connect to AP:

```
Ruijie#sh ac-config client by-ap-name
===== show sta status =====
AP   : ap name/radio id
Status: Speed/Power Save/Work Mode, E = enable power save, D = disable power save

Total Sta Num: 1
```

STA MAC	IPV4 Address	AP	Wlan	Vlan
Status	Asso Auth Net Auth	Up time		
6809.27b0.169f	192.168.200.1	1414.4b13.c248/1	1	200
65.0M/D/bn	WPA2_PSK	0:00:02:06		

2) Check AP config on AC:

```
Ruijie#sh ap-config summary
===== show ap status =====
Radio: E = enabled, D = disabled, N = Not exist
      Current Sta number
      Channel: * = Global
      Power Level = Percent
Online AP number: 1
Offline AP number: 0
AP Name          IP Address      Mac Address      Radio 1          Radio 2
Up/Off time      State
AP name          AP address      AP mac-address    2.4G             5.8G
AP connect time  AP running state

-----
      1414.4b13.c248  192.168.100.1  1414.4b13.c248 E      1      1* 100 E  0  149* 100
0:01:05:50      Run
```

4.1.6 FAQ

4.1.6.1 Does the CAPWAP tunnel support cross-NAT networking?

Yes, it supports.

If the AP is on the NAT intranet,

You do not need to configure the static IP address mapping or port mapping for the AP. You just need to configure the source IP address conversion to ensure the connectivity between the AP and the AC.

If the AC is on the NAT intranet,

1. On the egress router, configure mapping for UDP ports 5246 (control channel) and 5247 (data channel) with an AC address indicated by option 138.
2. The IP address of the AC (optional 138 IP address) on the AP is the public network address of the AC after mapping.

If the AP and the AC are on its own NAT intranet, the above three configurations must be met.

4.1.6.2 The CAPWAP tunnel cannot be created.

(1) Communication between the AP and the AC is abnormal.

The AP fails to get the IP address.

The AP fails to get the Option 138 field.

The AP fails to ping the AC to create the tunnel.

The CAPWAP UDP ports 5246 and 5247 are discarded or filtered out by an intermediate device.

(2) The AC and AP are in abnormal status.

The AP cannot go online due to a high AC CPU usage.

```
show cpu
```

The AC license is insufficient.

```
show ac-config
```

```
show license
```

```
show ap-config summary
```

The AC and AP version span is large (recommend to use same version for AP and AC).

The AP name is not unique.

```
19 16:37:19: CD-AC4 %APMG-6-AP_ADD: Add AP(1414.4b5d.03af) fail. Online-AP(1414.4b5d.097f) with same name(XS10A4-1) has exist in this AC
```

Modifies name of online AP.

Collect the following information and contact Ruijie TAC.

(1) Collect the following information on the AC:

```
show version
```

```
show running
```

```
show ac-config
```

```
show license
```

```
show ap-config summary
```

```
show capwap sta
```

```
show cpu
show memory
show ip route
show ip interface brief
```

(2) Collect the following information on the AP:

```
show version
show ap-mode
show capwap sta
show ip route
show log
show capwap client state
```

4.1.6.3 How to check the reason why the AP is rejected from going online.

When the link is normal and the AC has received the packet from the AP but the capwap tunnel cannot be established between the AP and the AC, run the ***show ap-config summary deny-ap*** command to display the specific cause or in combination with the logs displayed on the AC.

```
Ruijie#show ap-config summary deny-ap
```

```
Deny ap num: 1
```

```
Mac Address    AP Name                Reason
```

```
-----
1414.4b71.98a1                By conflict
```

By bind-ap-mac //The AP-MAC binding is rejected. The MAC whitelist bind-ap-mac is enabled on the AC but the MAC of this AP does not exist in ap-config.

By wtp-limit //Indicates that the maximum number of online APs has reached. A common cause is that the license is insufficient or the maximum number of online APs has reached. It is rarely caused by the wtp-limit configuration.

By conflict //Indicates that the AP name conflicts with the MAC name. It is because the AP name has already existed on the AC or other APs of this MAC are online or configured.

By deny-flag //The AC denies the AP to join it. A common cause is that deny-join is configured during networking and debugging.

By ap-auth //Indicates that the AP certification is restricted. Certification by the certificate, serial number or password is enabled on the AC but the AP does not carry any certification information.

By user-class //Indicates the APs belong to different classes. For example, SMB-AP can only access SMB-AC but cannot access ordinary ACs.

By overdue-ap //Indicates the AC has an expired AP. This problem is temporary generally. The AC will automatically clear expired APs and then the expired APs can join the AC again.

By master-ap-mac //Indicates that the satellite AP does not carry the master AP MAC. This problem is temporary generally and is caused by quick AP join during startup of the satellite AP.

By unknown //Indicates an unknown cause.

By radio num //Indicates that interconnection is not supported because the AP has too many RF interfaces. For example, the B7-version AC does not support AM5528.

By vendor id //Indicates that the interconnection is not supported because the AP of another vendor is used.

By new-ap-limit //Indicates that the number of the new APs reaches the upper limit. For example, WS5708 supports up to 100 B9-version APs of wave 2.

By local-limit //Indicates that the number of APs connected to the AC is limited due to the AC protection in VAC scenario. It is possibly because the switch load is unbalanced or the working ACs are insufficient.

By hot-backup //Indicates a hot-backup limit. For example, the AP uses the AP virtualization technology which does not support the hot-backup function. But hot-backup is enabled for this AP in the configuration.

By total-ap-num //The total number of APs (online + offline) and AP tunnels has reached the upper limit. Delete unwanted offline APs.

By none-radio //The AP is rejected because it does not carry radio. This problem is temporary generally and is caused by quick AP join during startup.

When the packet interaction between the AP and the AC is abnormal, capture packets from the intermediate line to locate the packet loss point and troubleshoot the wired network.

4.1.6.4 The AC cannot distribute the configuration to the AP.

[Symptom]

The AC cannot distribute the configuration to the AP.

[Environment]

The AP goes online to the AC across the public network.

[Possible Causes]

- (1) The AP does not go online.
- (2) The software version conflicts.
- (3) The extranet is restricted.
- (4) The software has a fault (due to causes such as large version span).

[troubleshooting Steps]

- (1) Remotely view whether the AP version is consistent with the AC version and whether the AP has gone online successfully.

(2) Run the **show ap-conf run** command to check whether the AP has joined the group and whether the active/standby configurations are consistent.

(3) Ping the AP to the AC. If the package size is 1500 bytes, the AC cannot be pinged. The dichotomic test result shows that the maximum package size that can be pinged is 1410 bytes. Modify the control tunnel MTU to 1410 to solve the problem:

```
ac-controller
```

```
capwap ctrl-mtu 1410
```

[Summary and Precautions]

In the cross-NAT go-online environment, the following problems may occur: the AC configuration cannot be issued, the tunnel cannot be established or is repeatedly established, and the terminal cannot be accessed. After troubleshooting, check whether the large-package communication between the AP and the AC is normal. For repeated tunnel establishment, check whether the NAT entry aging time of the egress is too short by testing the tunnel keepalive time.

4.1.6.5 In the cross-public-network scenario, only part of APs can go online on the AC.

[Symptom]

In cross-public-network mode, only part of APs can go online on the AC.

[Troubleshooting Steps]

(1) Check the network topology, wireless configuration and version.

A. Deploy the APs and the AC (a single AC, no active-standby ACs) across the public network. In hot-backup mode, check whether configurations of the active and standby ACs are the same. Configurations of normal APs and failed APs are exactly the same and the **bind-ap-mac** configuration is not set.

B. Requests of local users are locally forwarded, and gateway of APs and wireless users and the DHCP address pool are on the local aggregation switch. Troubleshoot the local device.

C. The AC, normal APs and abnormal APs are all of the latest version, and online APs are of the same model. It means that the problem is not caused by the version and public network line of the carrier.

(2) Log on to the failed AP to check the AP mode and confirm whether any IP address is obtained. Check whether the large packet can be communicated on the tunnel used for the AP to ping the AC.

Onsite check finds that the failed APs are in fit mode, the IP address can be obtained, and the large packet can be communicated on the tunnel.

(3) After check, we do not find any configuration difference between the access switch and the normal and failed AP interfaces, and the switch is in normal status.

(4) Collect logs and debugs on the failed APs and the AC.

The failed APs are always sending discovery request packets. However, after the **show capwap statistics** command is run on the AC, the number of received discovery request packets does not increase. It is suspected that the discovery request packets are discarded by intermediate link. Since the APs go online cross the public network and there are normal and failed APs, the problem is not caused by the public network line. It may be caused by the local device.

(5) Check the local device topology, egress EG, aggregation switch, access AC, and APs and capture packets at the uplink interface of the aggregation switch. Discovery request packets of failed APs are found. It is suspected that the packets are discarded at the egress EG device. Because we cannot directly capture packets for analysis at the egress, it is suspected that the application cannot identify the packets or the packets are discarded because traffic of packets from the APs to the AC is too large, and thus some tunnels between APs and the AC cannot be created.

(6) Add the AP network segment to the egress device free of auditing and flow control, and place resources of users at this segment to the EG key channel for preferential forwarding. The test result shows that the failed APs can go online normally. After the resources are moved out of the key channel, the APs go offline after a period of time and cannot go online again.

[Cause]

Traffic on the key channel of the egress traffic control device is too large and thus the interaction packet for creating a tunnel between the AP and the AC is discarded.

[Solution]

Add traffic in the AP IP address segment to the key channel of EG egress, to ensure that the AP packets are preferentially forwarded.

[Other Operation Commands]

Ø On the AC, run the **debug apmg join** command to check whether the discovery request packet is received.

Ø On the AP, run the **debug capwap client fsm** command to check whether the packet is successfully sent.

Ø On the AP, run the **debug capwap packet** command to check whether the discover response packet is received. The prompt is displayed later.

If no response packet is received, run the following command on the AC:

```
debug efmp packet filter ipv4_sport range 5246 5247 counter 30
```

Ø If the AP tunnel cannot be created, run the following command on the AC to see whether a prompt is displayed:

```
debug efmp packet filter ipv4_sip host AP IP address ipv4_sport eq
```

```
10000 counter 10
```

```
run-system-shell
```

```
dmesg
```

Ø On the AC, run the **show capwap ap tunnel id detail** command to see the following information:

```

WS#show capwap 1 detail
CAPWAP process "capwap 1" with state [ Run ]
Process uptime is 0 days 16 hours 20 minutes 0 seconds
Echo interval is 5 secs, Dead interval is 15 secs Expire 11 secs
Current timers EchoInterval
Peer address 192.168.253.251
The MAC of AP is 5869.6c1b.0ae7
The Session ID of AP is 58696c1b.0ae7dc04.672dfe2e.195a9aac
Capwap fragment is enable
The Path MTU is 1400
Recent received request's sequence number 137
Recent received response's sequence number 117
Recent send request's sequence number 117
Retransmit Count 0, Failed DTLS Session Count 0
Max Retransmit Count 5
Config maxretransmit 5
Sending queue length 0, Receive queue length 0
Peer control port is 10000, data port is 10001
My address is 1.1.1.1
CTI ifx is 12.
IPv4 control socket 4, data socket 5
IPv6 control socket 6, data socket 7
Local IPv4 address is 192.168.253.251
UDP checksum is disable
Peer notify in NAT: NO
Data crypt capacity plain
Am I AP :NO
DTLS is Not connect
Am I sw ap: NO

```

If the data port changes frequently, the traffic table is aging. You are recommended to adjust the channel keepalive time to a smaller value.

ap-config xxx

echo-interval xx (default: 30s; minimum: 5s; maximum: 255s)

4.1.6.6 The AC and AP versions are the same but the AP cannot go online on the AC and the progress stops at Join.

[Symptom]

The AC and AP versions are the same but the AP cannot go online on the AC.

[Analysis]

1. View the log to check the CAPWAP tunnel status of the AP. The result shows the AP has communicated with the AC and its status after the join status is:

DTLS Teardown;

```
*Jan1 00:01:10: %CAPWAP-6-STATE_CHANGE: (peer - 1) [1.1.1.1] capwap state changed, from <DTLS Setup> to <Join>
```

```
*Jan1 00:01:10: %CAPWAP-6-STATE_CHANGE: (peer - 1) [1.1.1.1] capwap state changed, from <Join> to <DTLS TearDown>
```

2. After confirming the link between the AC and the AP is normal, run the **show ap-config summary deny-ap** command. The result shows that the fault reason is "By conflict", which means the AP name is not unique in the system and thus the AP cannot join the AC.

```
JH_M8600WS_Master#show ap-c summary deny-ap
Deny ap num: 5
Mac Address      AP Name          Reason
-----
5869.6c89.61f0  yk_rsyl_ap2     By conflict
5869.6c5d.2739  yk_rsykzb_3fap2 By conflict
5869.6c89.61a0  yk_rsyz_ap1     By conflict
5869.6c89.5b8c  yk_rsyl_ap1     By conflict
5869.6c88.e996  yk_rsykzb_2fap2 By conflict
```

3. After you restore the default settings of the AP or change its name, the AP goes online successfully.

[Summary]

During the go-online process of the AP, the CAPWAP tunnel status is idle-->discover-->DTLS Setup-->Join-->config-->Data Check-->Run respectively. When the CAPWAP tunnel reaches the Run status, the AP has gone online successfully.

If the progress stops when the CAPWAP tunnel reaches the Join status, run the **show ap-config summary deny-ap** command to display the reason for access denying (the reason is not displayed when the AC version is 11.x and the AP version is 10.x due to a large version span).

The following are common causes for that the progress stops when the CAPWAP tunnel reaches the Join status:

- (1) The AP name conflicts.
- (2) The versions are inconsistent.
- (3) The license is incorrect.
- (4) The line has a fault.
- (5) The AC has security restrictions, for example, bind-ap-mac.

4.1.6.7 An offline AP is still displayed as "Online" on the AC.

[Symptom]

An offline AP is still displayed as "Online" on the AC.

[Analysis]

(1) Run the **show run** and **show ap-configrun** commands to display the configuration and check whether echo-interval is changed. (The default value is 30s.)

2. The result shows that the parameter value is still the default value. On the AC, run the **show capwap index detail** command several times. The keepalive value remains unchanged. It is suspected that the AP status is not updated on the AC because the keepalive function is disabled. Run the **show capwap [ip addr] detail | inc Echo** command. The result shows that the echo-interval is 0s.

```
AC-branch(config-ap)#show capwap 10.121.121.129 detail | in Echo
```

```
Echo interval is 0 secs, Dead interval is 0 secs Expire 4294967237 secs
```

3. Run the **show cli record** command to display the AC historical command records. The result shows that echo-interval disable is set for the AP-Group of the AP. Delete the configuration, the problem is solved.

[Summary]

This fault is caused by incorrect configuration of the hidden command. `echo-interval disable` is used to disable the echo function of the CAPWAP tunnel. After configuration, the AP echo function is disabled and the status of the AP is still displayed as "Run" after the AP goes offline. Besides, `echo-interval disable` is not displayed in the **show run** command.

The default echo interval between an AP and an AC is 30s. If the AC does not receive any echo packet from the AP within 30s, the AP goes offline.

The AP keeps alive the tunnel by sending an echo request every 30s. After receiving the echo request, the AC sends an echo response. If receiving no echo response within a certain period of time, the AP resends the echo request. The first retransmit starts at the 3rd second. When the time reaches the half of the echo interval, the AP deems that the tunnel is disconnected. The AP performs five retransmits within the 30s echo interval, that is, the 3rd second, 6th second, 12th second, 15th second, and 15th second.

Even if the echo interval is changed to another value, the calculation method for the retransmit time and count is still the same. The echo interval range is 5-255s, which is configured by the **echo-interval** *command in AP or AP group configuration mode.

4.1.6.8 Most APs cannot go online, online APs often go offline and the tunnel status frequently changes.**I. Symptom**

Most APs cannot go online, online APs often go offline and the tunnel status frequently changes.

II. Troubleshooting Steps

(1) Check the network topology, wireless configuration, version, and log.

The version configurations are consistent.

```
Oct 16 00:24:27: %CAPWAP-5-RETRANS_MAX: (*2) (peer - 47) [172.17.6.30 : 10000] reach maximum retransmit count [5],  
msg is [configuration update request], seq is [1], elem length is [34].
```

```
Oct 16 00:24:27: %CAPWAP-6-PEER_NOTIFY_DOWN: (*2) Peer <172.17.6.30 : 10000 : 5869.6cea.d18d> DOWN, reason  
<Retransmit MAX>.
```

The intermediate line may have a fault.

(2) Log on to the failed AP to check the AP mode and confirm whether any IP address is obtained. Check whether the large packet can be communicated on the tunnel used for the AP to ping the AC.

Packet loss is rare during AC ping on the AP. **The intermediate line may have a loop or the broadcast traffic is too large.**

(3) Log on to the AC and run the **clear counters** command to clear the interface traffic statistics. After **show int counters summary** is collected for three consecutive times, the broadcast packets at the interconnected interface increases quickly, as shown in the following figure:

```

RG-WS6816-VAC#show int counters summary
Interface      InOctets      InUcastPkts      InMulticastPkts      InBroadcastPkts
-----
G11/0/5        0              0                0                    0
G11/0/6        0              0                0                    0
G11/0/7        0              0                0                    0
G11/0/8        0              0                0                    0
G12/0/5        0              0                0                    0
G12/0/6        0              0                0                    0
G12/0/7        0              0                0                    0
G12/0/8        0              0                0                    0
Te1/0/1        0              0                0                    0
Te1/0/2        906285203     42787            952920               11748863
Te1/0/3        185309        439              45                   0
Te2/0/1        0              0                0                    0
Te2/0/2        101346945    510              95136                9905
Te2/0/3        312825       576              46                   0
Ag1            1007632148   43297            1048056              11758768
Interface      OutOctets      OutUcastPkts      OutMulticastPkts      OutBroadcastPkts
-----

```

(4) Log on to the interconnected core devices and run the **clear counters** command to clear the interface traffic statistics. After **show int counters summary** is collected for three consecutive times, the following figures are displayed:

```

VSU-RG18014#clear counters
VSU-RG18014#show int counters summary
Interface      InOctets      InUcastPkts      InMulticastPkts      InBroadcastPkts
-----
Te1/1/48      0              0                0                    0
Te1/3/1       0              0                0                    0
Te1/3/2       0              0                0                    0
Te1/3/3       0              0                0                    0
Te1/3/4       0              0                0                    0
Te1/3/5       0              0                0                    0
Te1/3/6       0              0                0                    0
Te1/3/7       0              0                0                    0
Te1/3/8       0              0                0                    0
Te1/3/9       0              0                0                    0
Te1/3/10      0              0                0                    0
Te1/3/11      0              0                0                    0
Te1/3/12      0              0                0                    0
Te1/3/13      0              0                0                    0
Te1/3/14      0              0                0                    0
Te1/3/15      0              0                0                    0
Te1/3/16      0              0                0                    0
Te1/3/17      0              0                0                    0
Te1/3/18      0              0                0                    0
Te1/3/19      0              0                0                    0
Te1/3/20      0              0                0                    0

```

```

VSU-RG18014#show int counters summary
Interface      InOctets      InUcastPkts      InMulticastPkts      InBroadcastPkts
-----
Te1/1/48      0              0                0                    0
Te1/3/1       4390           2                3                    44
Te1/3/2       0              0                0                    0
Te1/3/3       6245           1                3                    55
Te1/3/4       0              0                0                    0
Te1/3/5       4133           3                4                    30
Te1/3/6       0              0                0                    0
Te1/3/7       5313           4                2                    39
Te1/3/8       956            1                0                    12
Te1/3/9       0              0                0                    0
Te1/3/10      9938           5                2                    53
Te1/3/11      5636           3                4                    47
Te1/3/12      2166           0                2                    18
Te1/3/13      1071           3                1                    8
Te1/3/14      6301           1                4                    56
Te1/3/15      4412           5                2                    38
Te1/3/16      4496           3                3                    41
Te1/3/17      4664           2                3                    38
Te1/3/18      12609         3                16                   77
Te1/3/19      5716           3                4                    54
Te1/3/20      593079485     6366             167837               3226569
Te1/3/21      0              0                0                    0
Te1/3/22      5051           0                6                    44

```

A great amount of broadcast packets increase at the Te1/3/20, indicating that a loop may exist.

(5) After confirming that the device connected to the Te1/3/20 interface is the AP of the access switch, down the Te1/3/20 interface to check whether all the APs under the Te1/3/20 interface go online one after another and the network is recovered.

(6) Log on to the access switch and enable RLDP. It is found that one interface is in down state. Check connection status of the associated device. The result shows that the switch is a private switch and has a loop.

III. Cause

The switch connected to the access switch has a loop at a single port.

IV. Solution

shutdown the loop interface.

V. Summary

(1) When a tunnel cannot be established or is established repeatedly for some APs, a loop may exist. Even if no loop exists, packet loss is impossible when you ping the AC on the AP.

(2) After a similar fault occurs, check the fault scope and active-standby configuration consistency.

(3) If the load balancing policy is incorrectly configured in VAC, the AP may often go online and offline frequently or cannot go online.

(4) In case a loop exists, enable the tree generation or RLDP function and query the switch logs to check the information of the failed port having the loop.

4.1.6.9 Troubleshooting Method and Fault Information Collection for Tunnel Establishment Failure Due to the AP Fault

Troubleshooting Method and Fault Information Collection for Tunnel Establishment Failure Due to the AP Fault

(1) Check the module and version of the AP and AC, and networking topology and solution.

(2) Run the following command to check whether the communication on loopback0 (or capwap ctrl-ip x.x.x.x) between the AP and the AC is normal:

(3) Check the logs on the AP and AC and collect the debug information about the AP and AC.

Log on to the AP:

```
show log //Collects the AP logs.
```

```
more ap_down.txt //Displays the cause for AP offline.
```

```
show capwap statistic //Collects the AP tunnel establishment status information. The information can be collected for multiple times, up to consecutive three times.
```

```
show capwap client state
```

```
//When the AP does not identify efmp, enable debug efmp for the run-system-shell configuration.
```

```
run-system-shell cd sbin
```

```
./efmp_demo &
```

```
exit
```

Collect the Debug Information

```
terminal monitor
```

```
debug capwap client fsm
```

```
debug capwap packet
```

```
debug efmp packet filter ipv4_sport range 5246 5247 count 30
```

Log on to the AC:

```
show log
```

```
show ap-config summary deny-ap
```

```
terminal monitor
```

```
debug capwap [apip] packet
```

```
debug apmg join
```

```
debug efmp packet filter ipv4_sport eq 5247 ipv4_sip host [apip] count 10
```

(4) If no log or debug information is returned from the device end, troubleshoot the intermediate line. Run the **tracert ip tunnel ip source [apip]** command to trace the tunnel IP address record route on the AP to view which devices the AP packet has passed.

(5) Perform segmented packet capturing in the dichotomic method to check the sending and receiving of the packet that is used for establishing a tunnel between the AP and the AC and locate the packet loss point.

4.1.6.10 Can the AP and the user be in the same VLAN in the fit AP local forwarding mode?

Yes. The following configurations must be set:

```
Ruijie(config)# ap-config ap-name
```

```
Ruijie(config-ap)# ap-vlan vlan-id
```

 (The vlan-id must be the ID of VLAN of the AP and wireless user and must be configured; otherwise, the wireless user cannot obtain the IP address.)

ap-vlan command parsing: In local forwarding mode, the vlan-id configured by this command must be same to that allocated by STA. The actual VLAN of STA is assigned by the access switch of the AP instead of the VLAN configured by this command or assigned by the vlan-group. If the ap-vlan command is not configured, VLAN 1 is used by default.

Note: In local forwarding mode, even when the wireless user resides on VLAN 1, ap-vlan id must be configured on the AP. Otherwise, the wireless user can obtain the IP address of the AP network segment but cannot obtain the IP address of VLAN 1.

4.1.6.11 How to check whether the forwarding mode is local forwarding on the AP?

Run the following command on AP 11.x:

```
Ruijie#debug fwd dump-mode
```

wlan 1 tunnel local

Besides, you can query the MAC address table of the connected AP interface on the access switch of the AP. In local forwarding mode, the MAC address table of the wireless user is displayed.

4.1.6.12 When the wireless user resides on VLAN 1 while the AP resides on another VLAN in local forwarding mode, the IP address of the AP VLAN is obtained by the wireless user?

When the wireless user resides on VLAN 1 in local forwarding mode, the ap-vlan of the AP must be configured on the AC.

```
Ruijie(config)#ap-config 5869.6c84.b278      ---5869.6c84.b278 is the AP name.
```

```
Ruijie(config-ap)#ap-vlan 11      ---11 is the AP VLAN ID.
```

4.2 Fat AP Configuration

4.2.1 FAT AP (General)

Scenario

The APs independently complete the conversation between 802.11 frames and 802.3 frames for communication between the wired and the wireless networks.

Advantage: No need to change the current wired network architecture, simple configuration

Disadvantage: Non-unified management and configuration

I. Requirements

Add a new AP to amplify the coverage of wireless network.

Fat AP brocast 2 ssids, STA can connect to each ssid

II. Network Topology

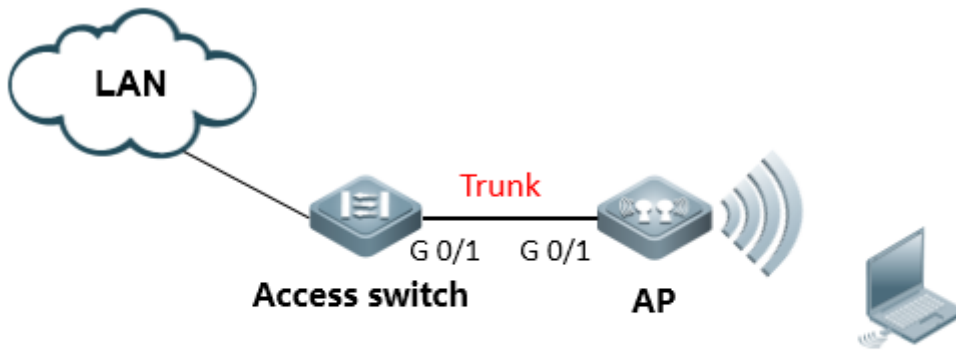

SSID	vlan	IP subnet
ruijie1	vlan10	172.16.10.0/24
ruijie2	vlan20	172.16.20.0/24

III. Configuration Tips

- 3.1 Connect console
- 3.2 Set AP mode fat
- 3.3 Create Vlan
- 3.4 Configure Dot1Q
- 3.5 Configure SSID
- 3.6 Configure Radio interface
- 3.7 Associate SSID
- 3.8 Configure MGMT IP and routing
- 3.9 Enable Broadcast
- 3.10 Configure Telnet
- 3.11 Configure switches
- 3.12 Other features of AP, like dhcp server、 authentication of wireless and encapsulation method, and so on.

IV. Configuration Steps

Step1: Connect console

```
Default password: ruijie
```

Step2: Set AP mode fat

```
Default mode: fit
Ruijie>ap-mode fat
```

Step3: Create VLAN and dhcp server (ignore dhcp configuration when using other dhcp server)

```
Ruijie>enable
Ruijie#configure terminal
```

```

Ruijie(config)#vlan 1
Note: VLAN 1 is only of local meaning
Ruijie(config-vlan)#vlan 10 ----->create user vlan10
Ruijie(config-vlan)#vlan 20 ----->create user vlan20
Ruijie(config)#service dhcp ----->enable dhcp service
Ruijie(config)#ip dhcp excluded-address 172.16.10.253 172.16.10.254 ----->these address will not assign to user
Ruijie(config)#ip dhcp excluded-address 172.16.20.253 172.16.20.254
Ruijie(config)#ip dhcp pool test_10 ----->config dhcp pool named with test_10
Ruijie(dhcp-config)#network 172.16.10.0 255.255.255.0
Ruijie(dhcp-config)#dns-server 218.85.157.99
Ruijie(dhcp-config)#default-router 172.16.10.254
Ruijie(dhcp-config)#exit
Ruijie(config)#ip dhcp pool test_20 ----->config dhcp pool named with test_20
Ruijie(dhcp-config)#network 172.16.20.0 255.255.255.0
Ruijie(dhcp-config)#dns-server 218.85.157.99
Ruijie(dhcp-config)#default-router 172.16.20.254

```

Step4: Configure dot1q

```

Ruijie(config)#interface GigabitEthernet 0/1
Ruijie(config-if)#encapsulation dot1Q 1
Ruijie(config)#interface GigabitEthernet 0/1.10
Ruijie(config-if)#encapsulation dot1Q 10
Ruijie(config)#interface GigabitEthernet 0/1.20
Ruijie(config-if)#encapsulation dot1Q 20

```

Step5: Configure SSID

```

Ruijie(config)#dot11 wlan 10
Ruijie(dot11-wlan-config)#broadcast-ssid
Ruijie(dot11-wlan-config)#ssid ruijie1
Ruijie(config)#dot11 wlan 20
Ruijie(dot11-wlan-config)#broadcast-ssid
Ruijie(dot11-wlan-config)#ssid ruijie2

```

Step6: Configure Radio interface

```

Ruijie(config)#interface Dot11radio 1/0.1
Ruijie(config-if-Dot11radio 1/0.1)#encapsulation dot1Q 1
Ruijie(config)#interface Dot11radio 1/0.10
Ruijie(config-if-Dot11radio 1/0.10)#encapsulation dot1Q 10 ----->encapsulation vlan 10
Ruijie(config)#interface Dot11radio 1/0.20
Ruijie(config-if-Dot11radio 1/0.20)#encapsulation dot1Q 20 ----->encapsulation vlan 20
Ruijie(config)#interface Dot11radio 2/0.10

```

```
Ruijie(config-if-Dot11radio 2/0.10)#encapsulation dot1Q 10 ----->encapsulation vlan 10
Ruijie(config)#interface Dot11radio 2/0.20
Ruijie(config-if-Dot11radio 2/0.20)#encapsulation dot1Q 20 ----->encapsulation vlan 20
```

Step7: Associate SSID

```
Ruijie(config)#interface Dot11radio 1/0
Ruijie(config-if-Dot11radio 1/0)#channel 1
Ruijie(config-if-Dot11radio 1/0)#power local 100
Ruijie(config-if-Dot11radio 1/0)#wlan-id 10
Config interface wlan id:10, SSID:ruijie1 // success log
Ruijie(config)#interface Dot11radio 1/0.1
Ruijie(config-if-Dot11radio 1/0.1)#wlan-id 20
Config interface wlan id:20, SSID:ruijie2 // success log
Ruijie(config)#interface Dot11radio 2/0
Ruijie(config-if-Dot11radio 2/0)#channel 149
Ruijie(config-if-Dot11radio 2/0)#power local 100
Ruijie(config-if-Dot11radio 2/0)#wlan-id 10
Config interface wlan id:10, SSID:ruijie1 // success log
Ruijie(config)#interface Dot11radio 2/0.1
Ruijie(config-if-Dot11radio 2/0.1)#wlan-id 20
Config interface wlan id:20, SSID:ruijie2 // success log
```

Note: Must follow up step 5、6、7 sequences exactly,check wifi signal after step 7

Step8: Configure MGMT IP and routing

```
Ruijie(config)#interface BVI 1 ----->configure MGMT IP address,vlan 1 map bvi 1
Ruijie(config-if)#ip address 172.16.1.253 255.255.255.0
Ruijie(config)#interface bvi 10
Ruijie(config-if-BVI 10)#ip address 172.16.10.253 255.255.255.0
Ruijie(config)#interface bvi 20
Ruijie(config-if-BVI 20)#ip address 172.16.20.253 255.255.255.0
Ruijie(config)#ip route 0.0.0.0 0.0.0.0 172.16.1.254
Ruijie(config)#end
Ruijie#write
```

Step9: Enable Broadcast

```
Ruijie(config)#data-plane wireless-broadcast enable
```

Note: If dhcp server is configured on uplink equipment, please enable wireless brocast function on AP, otherwise, STA obtain dhcp address in unstable situation.

Step10: Config telnet

```
Ruijie(config)#line vty 0 4
```



```
Ruijie(config-line)#password ruijie
Ruijie(config-line)#exit
Ruijie(config)#enable password ruijie
```

Step11: Config switch

```
Access_switch:
Aggregate_switch(config)#vlan 1
Aggregate_switch(config-vlan)#exit
Aggregate_switch(config)#interface vlan 1
Aggregate_switch(config-VLAN 1)#ip address 172.16.1.254 255.255.255.0
Aggregate_switch(config)#interface vlan 10
Aggregate_switch(config-VLAN 10)#ip address 172.16.10.254 255.255.255.0
Aggregate_switch(config)#interface vlan 20
Aggregate_switch(config-VLAN 20)#ip address 172.16.20.254 255.255.255.0
Aggregate_switch(config-VLAN 20)#exit
Aggregate_switch(config)#interface gigabitEthernet 0/1 // downlink to AP
Aggregate_switch(config-GigabitEthernet 0/1)#switchport mode trunk
Access_switch(config)#interface gigabitEthernet 0/2 //access switch uplink
Access_switch(config-GigabitEthernet 0/2)#switchport mode trunk
```

Tip:

Vlan 10, "10"represent vlan-id 10; dot11 wlan 10, "10"represent wlan-id 10.

Vlan 20, "20"represent vlan-id 20; dot11 wlan 20, "20"represent wlan-id 20.

V. Verification

- 1) Check whether WIFI signal has been broadcasted or not with command "show dot mb" on AP.
- 2) Check WIFI signal strength with command "show dot a a" on AP.
- 3) Check ip address and ping gateway

4.2.2 FAT AP (for wall AP)

Scenario

The APs independently complete the conversation between 802.11 frames and 802.3 frames for communication between the wired and the wireless networks.

Advantage: No need to change the current wired network architecture, simple configuration

Disadvantage: Non-unified management and configuration

I. Requirements

Add a new AP to amplify the coverage of wireless network.

Tip: Only applicable for AP110-W and AP120-W

II. Network Topology

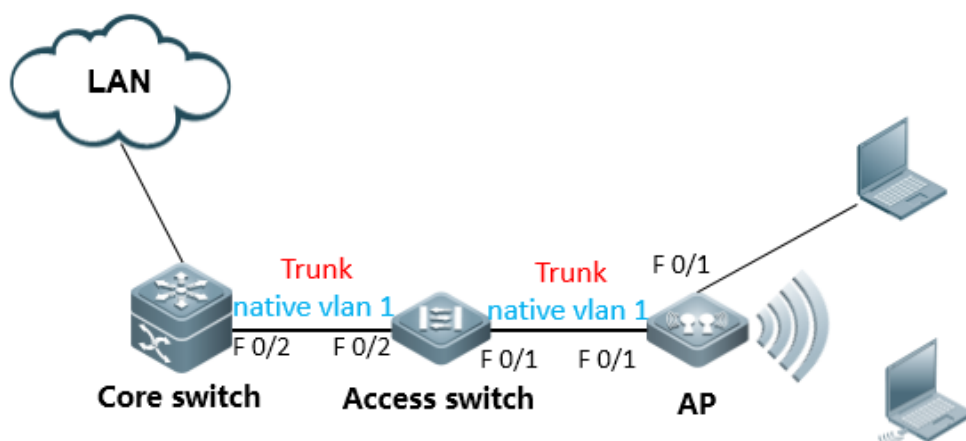

User	SSID	vlan	IP subnet
wireless user1	ruijie1	vlan10	172.16.10.0/24
wireless user2	ruijie2	vlan20	172.16.20.0/24
wired user(F0/2)		vlan30	172.16.30.0/24

Tip: Access switch should support to set trunk port and native vlan

III. Configuration Tips

1. AP telnet management
2. Enter privileged mode
3. Set AP to fit mode
4. Set enable pwd
5. Save config file
6. Reconnect telnet
7. Create Vlan
8. Config Wan interface Dot1Q
9. Create SSID
10. Create radio sub-interface
11. Associate SSID
12. Enable wireless Broadcast
13. IP setting and routing
14. Configure switches

IV. Configuration Steps

AP configure

Port indexing:



- ① Power
- ② (WAN) FA0/1
- ③ (LAN) FA0/2
- ④ LINE
- ⑤ PHONE

Note: AP130-W default mode: Fit.

Default IP: 192.168.110.1

Default PWD: ruijie

Firmware version: From 10.4(1b19)p2 173487 to the latest version

Fa0/1(locate in the back of panel) default IP: 192.168.110.1/24

Fa0/2(locate in the front of panel) default IP: 192.168.111.1/24

Firmware version: prior to 10.4(1b19)p2 173487

Fa0/1(locate in the back of panel) default IP: 192.168.1.1/24

Fa0/2(locate in the front of panel) default IP: 192.168.2.1/24

IV. Configuration Steps

Step1. AP telnet management (take the latest firmware for example)

- 1) Power on AP, connect PC to FA0/1(in the back)
 - : PC---POE---(FA0/1)AP
- 2) PC IP address: 192.168.110.2

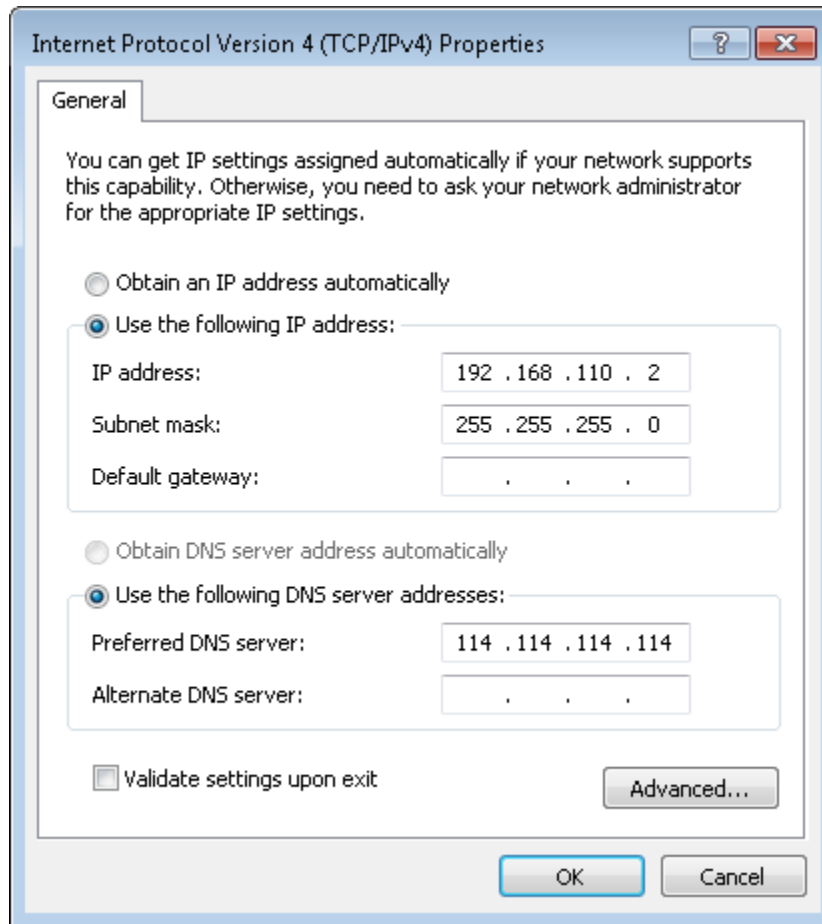

3) Telnet to AP

```
telnet 192.168.110.1
User Access Verification
Password:ruijie
```

2. Enter privilege mode

```
Ruijie>enable
Password:apdebug
Ruijie#
```

3. Set ap to fat mode

```
Ruijie#ap-mode fat
apmode will change to FAT.
```

Note: after mode change, FA0/1、FA0/2 change to layer 3 port, FA0/1 IP address: 192.168.110.1/24, FA0/2 IP address: 192.168.111.1/24

4. Set enable password

```
Ruijie(config)#enable password ruijie
```

5. Save config file

```
Ruijie#write
```

6. Create vlan

```
Ruijie(config)#vlan 10 ----->wireless user1 vlan
Ruijie(config-vlan)#vlan 20 ----->wireless user2 vlan
Ruijie(config-vlan)#vlan 30 ----->wired user vlan
Note: VID 10 is only of local meaning
Ruijie(config-vlan)#exit
```

7. IP setting

```
Ruijie(config)#interface BVI 30 ----->bvi 30 map to vlan 30
Ruijie(config-if-bvi)#ip address 172.16.30.100 255.255.255.0
Ruijie(config-if-bvi)#interface FastEthernet 0/2
Ruijie(config-if-FastEthernet)#encapsulation dot1Q 30 ----->port 1 (in the front of panel) encapsulation
vlan30
Ruijie(config-if-FastEthernet)#line vty 0 4 ----->configure telnet password
Ruijie(config-line)#password ruijie
Ruijie(config-line)#login
```

8. Reconnect

- 1) PC connect to FA0/2 (front panel)
PC-(FA0/2) AP
- 2) PC IP address 172.16.30.10
- 3) Telnet AP

```
telnet 172.16.30.100
User Access Verification
Password:ruijie
Ruijie>enable
Password:Ruijie
```

9. Configure interface fa0/1

```
Ruijie(config)#interface fastEthernet 0/1
Ruijie(config-if-FastEthernet 0/1)#encapsulation dot1Q 30 ----->should be consistent with fa0/2 vlan
Ruijie(config-if-FastEthernet 0/1)#interface fastEthernet 0/1.10
Ruijie(config-if-FastEthernet 0/1.2)#encapsulation dot1Q 10 -----> encapsulate sub-interface
Ruijie(config-if-FastEthernet 0/1.2)#interface fastEthernet 0/1.20
Ruijie(config-if-FastEthernet 0/1.3)#encapsulation dot1Q 20
```

10. Define SSID

```
Ruijie(config)#dot11 wlan 1
Ruijie(dot11-wlan-config)#ssid ruijie1 ----->SSID "ruijie1"
Ruijie(dot11-wlan-config)#vlan 10 ----->wireless user1 vlan
Ruijie(config)#dot11 wlan 2
Ruijie(dot11-wlan-config)#ssid ruijie2
Ruijie(dot11-wlan-config)#vlan 20
```

11. Create radio sub-interface

```
Ruijie(config)#interface dot11radio 1/0.10
Ruijie(config-subif)#encapsulation dot1Q 10 // encapsulte radio sub-interface
Ruijie(config-subif)#mac-mode fat
Ruijie(config-subif)#interface dot11radio 1/0.20
Ruijie(config-subif)#encapsulation dot1Q 20 // encapsulte radio sub-interface
Ruijie(config-subif)#mac-mode fat
```

12. Associate SSID

```
Ruijie(config)#interface dot11radio 1/0
Ruijie(config-if-Dot11radio 1/0)#wlan-id 1
Ruijie(config)#interface dot11radio 1/0.1
Ruijie(config-if-Dot11radio 1/0.1)#wlan-id 2
```

Note: MUST follow step 9,10,11,12 sequences exactly. check wifi signal after step 12

13. Enable wireless broadcast

```
Ruijie(config)#data-plane wireless-broadcast enable
```

14. Configure routing

```
Ruijie(config)#ip route 0.0.0.0 0.0.0.0 172.16.30.1
```

15. Configure DHCP service (optional feature)

```
Ruijie(config)#service dhcp ----->enable dhcp service
Ruijie(config)#ip dhcp excluded-address 172.16.10.1
Ruijie(config)#ip dhcp excluded-address 172.16.20.1
Ruijie(config)#ip dhcp excluded-address 172.16.30.1
Ruijie(config)#ip dhcp excluded-address 172.16.30.100
Ruijie(config)#ip dhcp pool ruijie1
Ruijie(dhcp-config)#network 172.16.10.0 255.255.255.0
Ruijie(dhcp-config)#dns-server 218.85.157.99
Ruijie(dhcp-config)#default-router 172.16.10.1
Ruijie(dhcp-config)#exit
Ruijie(config)#ip dhcp pool ruijie2
Ruijie(dhcp-config)#network 172.16.20.0 255.255.255.0
```

```
Ruijie(dhcp-config)#dns-server 218.85.157.99
Ruijie(dhcp-config)#default-router 172.16.20.1
Ruijie(dhcp-config)#exit
Ruijie(config)#ip dhcp pool ruijie3
Ruijie(dhcp-config)#network 172.16.30.0 255.255.255.0
Ruijie(dhcp-config)#dns-server 218.85.157.99
Ruijie(dhcp-config)#default-router 172.16.30.1
Ruijie(config)#interface bvi 10
Ruijie(config-if-BVI 1)#ip address 172.16.10.253 255.255.255.0
Ruijie(config-if-BVI 1)#interface bvi 20
Ruijie(config-if-BVI 2)#ip address 172.16.20.253 255.255.255.0
```

16. Save config file

```
Ruijie(dhcp-config)#end
Ruijie#write
```

Access switch:

1. configure interface

```
Ruijie>enable
Ruijie#configure terminal
Ruijie(config)#interface fastEthernet 0/1
Ruijie(config-if-FastEthernet 0/1)#switchport mode trunk
Ruijie(config-if-FastEthernet 0/1)#interface fastEthernet 0/2
Ruijie(config-if-FastEthernet 0/2)#switchport mode trunk
```

2. Create vlan

```
Ruijie(config)#vlan 10
Ruijie(config-vlan)#vlan 20
Ruijie(config-vlan)#vlan 30
Ruijie(config-vlan)#exit
```

3. Save config file

```
Ruijie(config)#end
Ruijie#write
```

Core switch:

1. Configure interface

```
Ruijie>enable
Ruijie#configure terminal
Ruijie(config)#interface fastEthernet 0/2
Ruijie(config-if-FastEthernet 0/2)#switchport mode trunk
```

```
Ruijie(config-if-FastEthernet 0/2)#exit
```

2. Create vlan

```
Ruijie(config)#vlan 10
Ruijie(config-vlan)#vlan 20
Ruijie(config-vlan)#vlan 30
Ruijie(config-vlan)#exit
```

3. Configure gateway

```
Ruijie(config)#interface vlan 10
Ruijie(config-if-vlan 10)#ip address 172.16.10.1 255.255.255.0
Ruijie(config-if-vlan 10)#interface vlan 20
Ruijie(config-if-vlan 20)#ip address 172.16.20.1 255.255.255.0
Ruijie(config-if-vlan 20)#interface vlan 30
Ruijie(config-if-vlan 30)#ip address 172.16.30.1 255.255.255.0
Ruijie(config-if-vlan 30)#exit
```

4. DHCP service (optional feature)

Note: dhcp service can be configured in ap or core switch, reference to ap config in step 15

4. save config file

```
Ruijie(config)#end
Ruijie#write
```

V. Verification

- 1) Check WIFI signal strength
- 2) Check ip address and ping gateway

4.3 Rate Limit

4.3.1 Fit AP

I. Requirements

To make limited network resources serve more users, ensure that the device supports the traffic rate limit function. When the data traffic accords with the committed rate, data packets are allowed to pass. When the data traffic does not accord with the committed rate, data packets are discarded.

II. Configuration Steps

Configuring Rate Limit on AC for Fit AP

AP based Rate Limit

```
Ruijie(config)#ap-config ap-name
Ruijie(config-ap)#ap-based { per-user-limit | total-user-limit } {down-streams | up-streams }
average-data-rate average-data-rate burst-data-rate burst-data-rate
```

Assign 800KBps average data rate and 1600KBps burst data rate to each wireless user **connected** to AP RJAP.

```
Ruijie(config)#ap-config RJAP
Ruijie(config-ap)#ap-based per-user-l
imit down-streams average-data-rate 800 burst-data-rate 1600
```

Attention: The unit is 8K Bit = 1K Byte.

Wlan based Rate Limit

```
AC(config)#wlan-config wlan-id
AC(config-wlan)#wlan-based { per-user-limit | total-user-limit | per-ap-limit } {down-streams | up-streams }
average-data-rate average-data-rate burst-data-rate burst-data-rate
```

Assign 800KBps average data rate and 1600KBps burst data rate to each wireless user **connected to WLAN "1"**.

```
AC(config)#wlan-config 1 RL
AC(config-wlan)#wlan-based per-user-limit down-streams average-data-rate 800 burst-data-rate 1600
```

MAC based Rate Limit

```
AC(config)#ac-controller
AC(config-ac)#netuser mac-address { inbound | outbound } average-data-rate average-data-rate
burst-data-rate burst-data-rate
```

Assign 800KBps average data rate and 1600KBps burst data rate to a single wireless user whose MAC address is 0001-0001-0001.

```
AC(config)#ac-controller
AC(config-ac)#netuser 0001.0001.0001 inbound average-data-rate 800 burst-data-rate 1600
```

Notes

The priority of Rate Limit

- (1) Netuser
- (2) wlan-based peruser
- (3) ap-based peruser

III. Verification

1. Connect to wlan and have speed test
2. Display QOS status on AC, execute commands "show dot11 ratelimit"

```

AC#show dot11 ratelimit wlan
Wlan Id TT_up-a-rt TT_up-b-rt TT_dw-a-rt TT_dw-b-rt PU-up-a-rt PU-up-b-rt PU-dw-a-rt PU-dw-b-rt PA_up-a-rt
PA_up-b-rt PA_dw-a-rt PA_dw-b-rt
-----
1      0      0      0      0      0      0      0      800      1600
0      0      0      0      0
AC#show dot11 ratelimit user
MAC Address      up-a-rate      up-b-rate      down-a-rate      down-b-rate
-----
0001.0001.0001 800            1600          0                0
AC#show dot11 ratelimit ap
AP name:test123, ratelimit info(unit:8kbps):
  Upstream : average rate - 0,  burst rate - 0
  Downstream: average rate - 800,  burst rate - 1600
Total-user-limit:
  Upstream : average rate - 0,  burst rate - 0
  Downstream: average rate - 0,  burst rate - 0

```

3. Total speed limit will be divided equally among all online users when configuring "wlan-based perap" or "ap total-user" on ap.

4.3.2 Fat AP

I. Requirements

To make limited network resources serve more users, ensure that the device supports the traffic rate limit function. When the data traffic accords with the committed rate, data packets are allowed to pass. When the data traffic does not accord with the committed rate, data packets are discarded.

II. Configuration Steps

Configuring Rate Limit on Fat AP

AP based Rate Limit

```

Format: FatAP(config)#wlan-qos ap-based { per-user-limit | total-user-limit } { down-streams | up-streams }
average-data-rate average-data-rate burst-data-rate burst-data-rate

```

Assign **800KBps** average data rate and **1600KBps** burst data rate to each wireless user **connected to this AP**.

```

FatAP(config)#wlan-qos ap-based per-user-limit down-streams average-data-rate 800 burst-data-rate 1600
Attention: The unit is 8K Bit = 1K Byte.

```

Wlan based Rate Limit

```
Format: FatAP(config)#wlan-qos wlan-based {wlan-id |ssid } { per-user-limit | total-user-limit } {down-streams |
up-streams } average-data-rate average-data-rate burst-data-rate burst-data-rate
```

Assign **800KBps** average data rate and **1600KBps** burst data rate to each STA **connected to Wlan ID 1**.

```
FatAP(config)#wlan-qos wlan-based 1 per-user-limit down-streams average-data-rate 800 burst-data-rate
1600
```

MAC based Rate Limit

```
Format: FatAP(config)#wlan-qos netuser mac-address { inbound | outbound } average-data-rate
average-data-rate burst-data-rate burst-data-rate
```

Assign **800KBps** average data rate and **1600KBps** burst data rate **to a certain wireless user whose MAC address is 0001-0001-0001**

```
Ruijie(config)#wlan-qos netuser 0001.0001.0001 inbound average-data-rate 800 burst-data-rate 1600
```

III. Verification

1. Connect to wlan and have speed test.
2. Display QOS status on Fat AP, execute commands "show dot11 ratelimit"

```
FatAP#show dot11 ratelimit wlan
Wlan Id TT_up-a-rt TT_up-b-rt TT_dw-a-rt TT_dw-b-rt PU-up-a-rt PU-up-b-rt PU-dw-a-rt PU-dw-b-rt PA_up-a-rt
PA_up-b-rt PA_dw-a-rt PA_dw-b-rt
-----
1      0      0      0      0      0      0      0      800      1600
0      0      0      0
FatAP#show dot11 ratelimit user
MAC Address up-a-rate up-b-rate down-a-rate down-b-rate
-----
0001.0001.0001 800      1600      0      0
FatAP#show dot11 ratelimit ap
AP name: test123, ratelimit info (unit:8kbps):
  Upstream: average rate - 0, burst rate - 0
  Downstream: average rate - 800, burst rate - 1600
Total-user-limit:
  Upstream: average rate - 0, burst rate - 0
  Downstream: average rate - 0, burst rate - 0
```

4.3.3 FAQ

4.3.3.1 How to display the rate limit configuration

If the AC configuration is as follows:

```
wlan-config 1 ruijie
```

```
wlan-based per-user-limit down-streams average-data-rate 10 burst-data-rate 10
```

Method is shown as follow: (same for the AC and the AP)

Command description:

```
show dot11 ratelimit {wlan | ap | user }
```

wlan: Indicates displaying all rate limit information of all WLANs.

ap: Indicates displaying all rate limit information of all APs.

user: Indicates displaying all rate limit information of all users.

4.3.3.2 What is the unit of the rate limit parameter in the rate limit command?

8 kbps.

For example, to set the download rate to 80 kbps, the command is

```
Ruijie(config-wlan)#wlan-based per-user-limit down-streams average-data-rate 10 burst-data-rate 10.
```

4.3.3.3 Precautions for Rate Limit in Local Forwarding Mode

In local forwarding mode, you can only limit the download traffic but cannot limit the upload traffic from STA to STA, because the traffic from STA to STA passes through the express forwarding path only once.

4.3.3.4 Can rate limit be set for WLAN-based users in local forwarding mode?

No. Because rate limit configured by the **wlan-based total-user-limit** command is realized on the AC, the configuration is only applicable for WLAN-based users in centralized forwarding mode.

4.3.3.5 Does the AP support multiple rate limits?

AP supports multiple rate limits.

When wlan-based per-ap, ap-based total-user, and netuser are configured simultaneously, the final rate limit is the effect when these three configurations take effect at the same time.

4.3.3.6 Which rate limit mode has a higher priority on the AC?

The AC supports AP-based, STA-based, and WLAN-based rate limit modes. The modes are described as follows:

(1) The rate limit modes wlan-based per-user-limit, wlan-based per-ap-limit intelligent, ap-based per-user-limit, ap-based total-limit intelligent, and netuser all function on STA but only one of them can work on STA at a time. The priority is

wlan-based per-user-limit > wlan-based per-ap-limit intelligent > wlan-based per-user-limit > ap-based total-limit intelligent > ap-based per-user-limit.

(2) The rate limit modes wlan-based total-limit, wlan-based per-ap-limit, and ap-based total-limit and the STA-based rate limit modes function on different objects and thus can take effect simultaneously,

4.3.3.7 What's intelligent rate limit?

AP in 11.x version supports intelligent rate limit. When wlan-based per-ap or ap-based total-user intelligent rate limit is configured, the AP intelligently assigns the total rate to all online users on average.

Command:

```
wlan-based per-ap-limit { down-streams | up-streams } intelligent
```

```
ap-based total-user-limit{ down-streams | up-streams } intelligent
```

Configuration Method:

Before configuring intelligent rate limit of a certain range, you need to configure the total rate limit in the range. Currently, the following two intelligent rate limit modes are supported:

In **wlan-based per-ap-limit** mode, the wlan-based total rate limit is configured for the WLAN of all the APs in the AC. If wlan-based per-ap-limit is configured and intelligent rate limit is enabled, all the APs intelligently allocate the total bandwidth to all the STAs in the WLAN on average.

In **ap-based total-user-limit** mode, a total rate limit is configured to the specified AP. If ap-based total-user-limit is configured and intelligent rate limit is enabled, this AP intelligently allocates the total bandwidth to all the STAs in this AP.

Example:

(1) When the per-ap-limit downlink rate limit of WLAN 1 on the AC is set to 1000 kbps and the intelligent rate limit is enabled, all the APs associated with WLAN 1 allocate 1000 kbps to all STAs of WLAN 1 on average. If five STAs are associated with WLAN 1, then the downlink rate limit is 200 kbps.

```
Ruijie(config)#wlan-config 1
```

```
Ruijie(config-wlan)#wlan-based per-ap-limit down-streams average-data-rate 1000 burst-data-rate 1000
```

```
Ruijie(config-wlan)#wlan-based per-ap-limit down-streams intelligent
```

(2) When the ap-based total-user-limit upload rate limit of AP 320 is set to 500 kbps on the AC and the intelligent rate limit is enabled, AP 320 allocates the 500 kbps to all STAs of AP 320. If five users are associated with AP 320, the upload rate limit of each user is 100 kbps.

```
Ruijie(config)#ap-config ap320
```

```
Ruijie(config-ap)#ap-based total-user-limit up-streams average-data-rate 500 burst-data-rate 500
```

```
Ruijie(config-ap)#ap-based total-user-limit up-streams intelligent
```

4.4 Wireless Security

4.4.1 Wireless Encryption (WPA/WPA2)

I. Requirements

Wireless user need to input password when connect to wireless network.

II. Network Topology

AC loopback0:1.1.1.1/32

AP:192.168.20.0/24

STA:172.16.1.0/24

AC:192.168.1.0/24

STA vlan 10

AP vlan 20

AC vlan 30

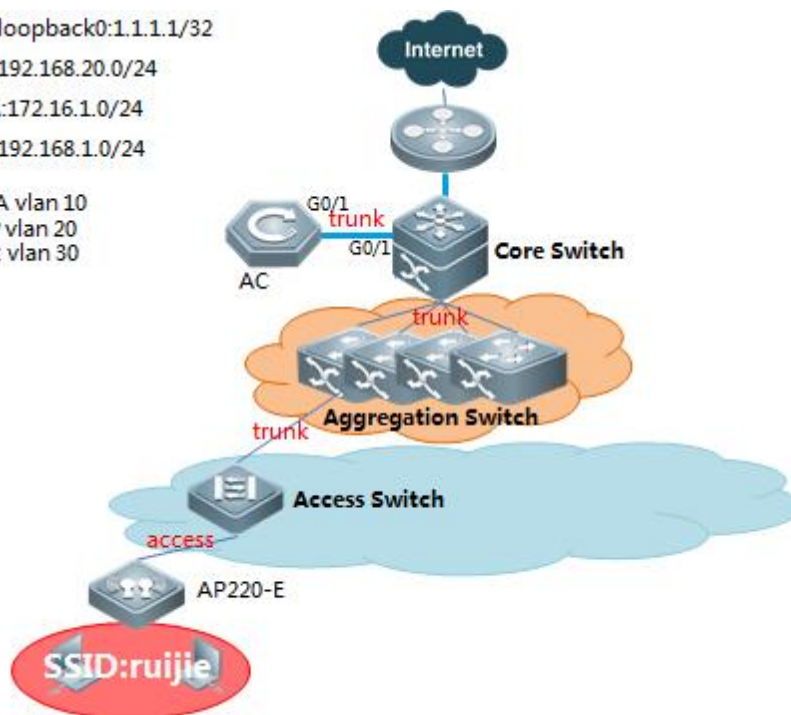

III. Configuration Tips

1. Configure wireless encryption
2. Configure wireless encryption type
3. Configure wireless password

IV. Configuration Steps

1. WPA configuration

```
WS5708(config)#wlansec 1
WS5708(config-wlansec)#security wpa enable ---->enable wpa
WS5708(config-wlansec)#security wpa ciphers aes enable ---->enable aes encryption
WS5708(config-wlansec)#security wpa akm psk enable ---->psk key management
```

```
WS5708(config-wlansec)#security wpa akm psk set-key ascii 1234567890 ---->wifi password, no less than 8 digits
```

2. WPA2 configuration **【recommand】**

```
WS5708(config)#wlansec 1
WS5708(config-wlansec)#security rsn enable ---->enable wpa2
WS5708(config-wlansec)#security rsn ciphers aes enable ---->enable aes encryption
WS5708(config-wlansec)#security rsn akm psk enable ---->psk key management
WS5708(config-wlansec)#security rsn akm psk set-key ascii 1234567890 ---->wifi password, no less than 8 digits
```

Note: One SSID can support both WPA and WPA2, but two passwords MUST match.

V. Verification

1. Connect to ssid

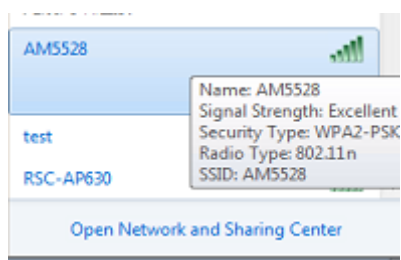

2. Type the key

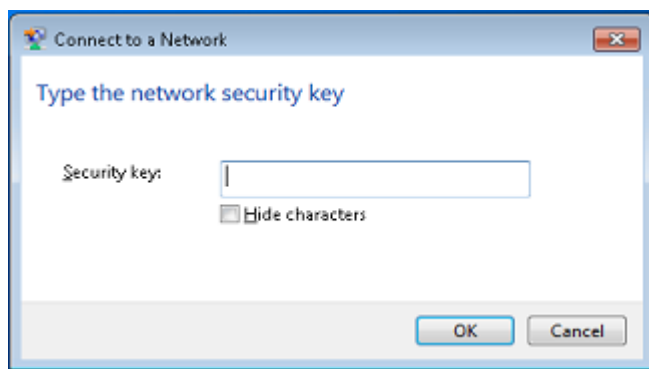

3. Check Wi-Fi association

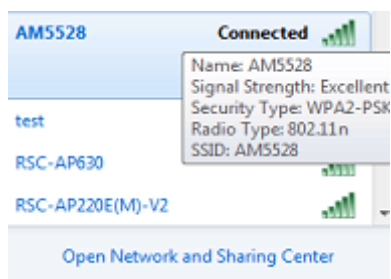

```

WS6008#sh ac-config client
***** show sta status *****
AP : ap name/radio id
Status: Speed/power Save/work Mode/roaming state, E = enable power save, D = disable power save

Total Sta Num : 1
-----
STA MAC      IPv4 Address      AP              wlan vlan status      Asso Auth      Net Auth      up time
-----
ec26.cae1.1999 172.29.6.138     AM5528/48      55 6      1/4.0M/D/an      WPA2_PSK      OPEN          0:00:04:59
WS6008#
    
```

4.4.2 Blacklist&Whitelist

4.4.2.1 STA Whitelist

Scenario

Frame filtering involves the configuration of white list, static blacklist and dynamic blacklist. When AP receives a data frame. It will check the MAC address of this data frame. The process of frame filtering is shown below:

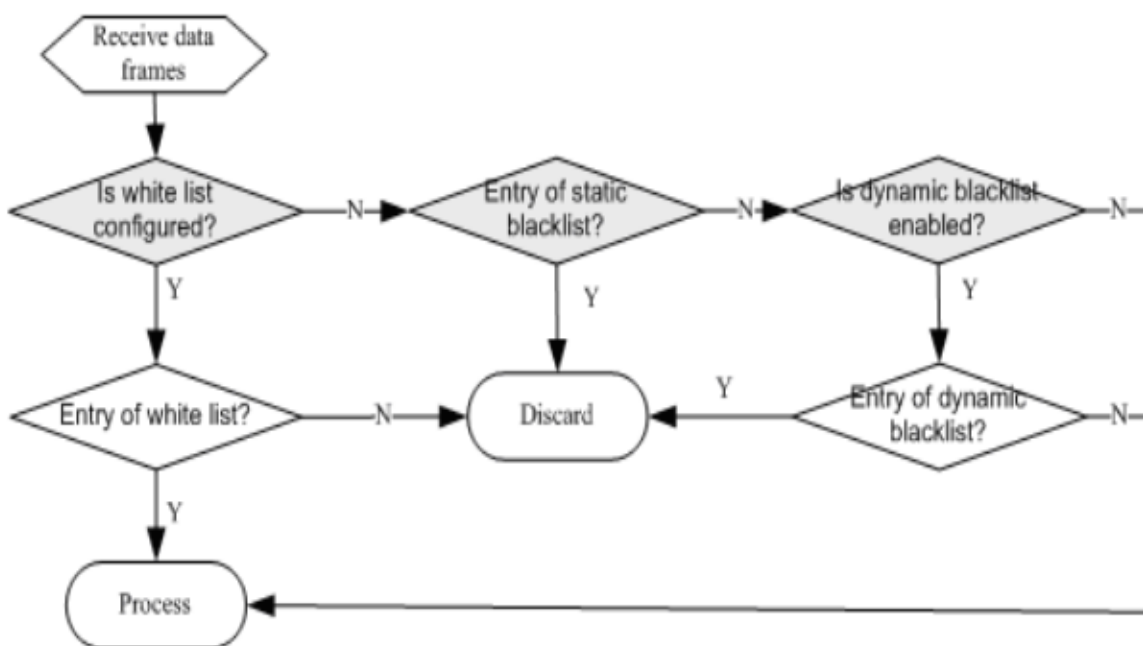

Figure flow of frame filtering

I. Requirements

Configure white list in WIDS configuration mode. When an entry exists in the white list, the corresponding client will pass frame filtering.

II. Network Topology

AC loopback0:1.1.1.1/32

AP:192.168.20.0/24

STA:172.16.1.0/24

AC:192.168.1.0/24

STA vlan 10

AP vlan 20

AC vlan 30

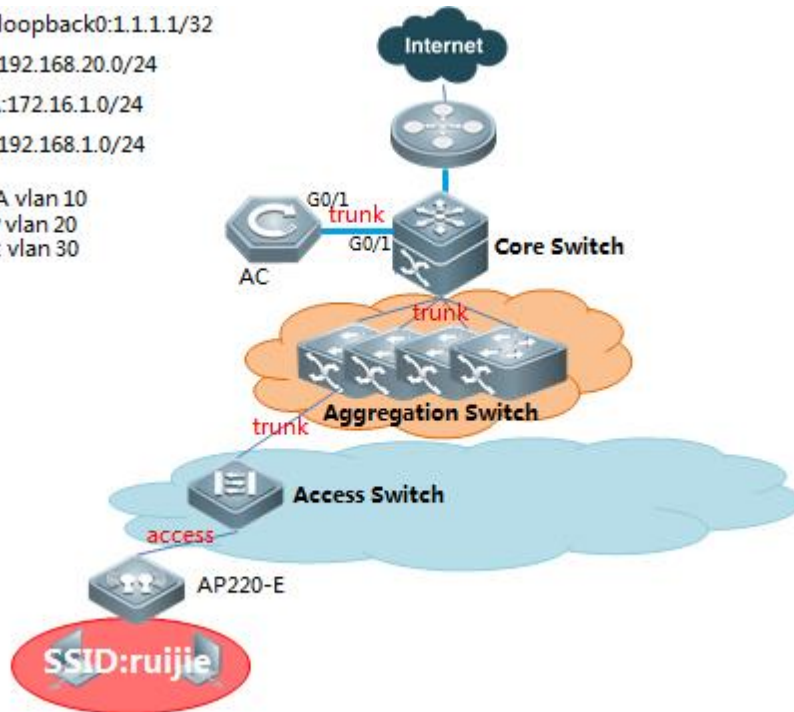

III. Configuration Tips

Configure whitelist (When an entry exists in the white list, the corresponding client will pass frame filtering)

Configure blacklist (When an entry exists in the black list, the corresponding client will be denied to pass)

IV. Configuration Steps

configure whitelist, sta mac-address: 6809.27b0.169f, 8ca9.829a.b1ea

```
WS5302(config)#wids
```

```
WS5302(config-wids)#whitelist mac-address 6809.27b0.169f -----> 6809.27b0.169f is allowed to access
```

```
WS5302(config-wids)#whitelist max 1024 ----->adjust whitelist capacity (range from 1-1024, optional config)
```

configure blacklist, sta mac-address: 6809.27b0.169f, 8ca9.829a.b1ea

```
WS5302(config)#wids
```

```
WS5302(config-wids)#static-blacklist mac-address 6809.27b0.169f ----->6809.27b0.169f is denied to pass
```

```
WS5302(config-wids)#static-blacklist max 1024 ----->adjust blacklist capacity (range from 1-1024, optional config)
```

V. Verification

1. When an entry exists in the white list, the corresponding client will pass frame filtering, STA MAC: 6809.27b0.169f, 8ca9.829a.b1ea

```
WS5302#show wids whitelist
```

```

-----      Whitelist Information      -----
num      Mac-address
1        6809.27b0.169f
WS5302#show ac-config client by-ap-name
===== show sta status =====
AP      : ap name/radio id
Status: Speed/Power Save/Work Mode, E = enable power save, D = disable power save
Total Sta Num: 1
STA MAC      IPV4 Address      AP                               Wlan Vlan Status
Asso Auth Net Auth  Up time
-----
6809.27b0.169f 192.168.20.1      1414.4b13.c248/1                1    20    52.0M/E/bn
WPA2_PSK      0:00:10:02

```

2. When an entry exists in the black list, the corresponding client will be denied to pass, STA MAC: (6809.27b0.169f, 8ca9.829a.b1ea)

```

WS5302#show wids blacklist static
-----      Static Blacklist Information      -----
num      Mac-address
1        6809.27b0.169f
WS5302#show ac-config client by-ap-name
===== show sta status =====
AP      : ap name/radio id
Status: Speed/Power Save/Work Mode, E = enable power save, D = disable power save

Total Sta Num: 1
STA MAC      IPV4 Address      AP                               Wlan Vlan Status
Asso Auth Net Auth  Up time
-----
8ca9.829a.b1ea 192.168.20.2      1414.4b13.c248/1                1    20
58.5M/D/bn      WPA2_PSK      0:00:00:24

```

4.4.2.2 SSID Whitelist

Scenario

Frame filtering involves the configuration of white list, static blacklist and dynamic blacklist. When AP receives a data frame, it will check the MAC address of this data frame. The process of frame filtering is shown below:

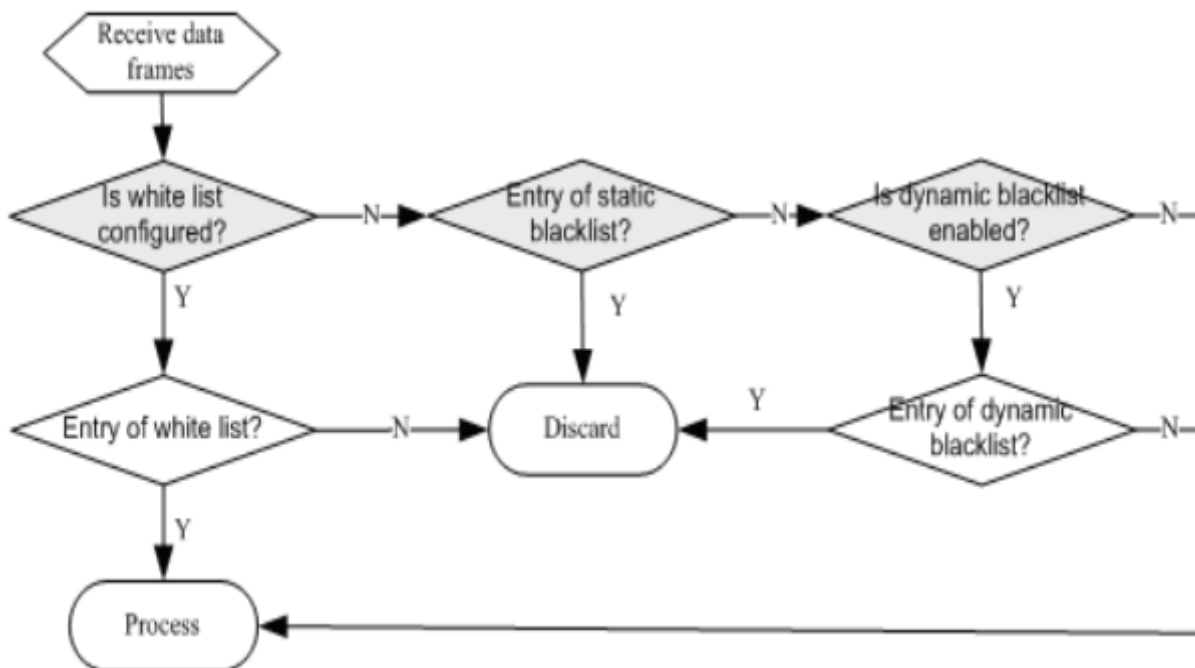

Figure flow of frame filtering

I. Requirements

Configure white list in WIDS configuration mode. When an entry exists in the white list, the corresponding client will pass frame filtering.

II. Configuration Tips

Configure whitelist based on SSID (When an entry exists in the white list, the corresponding client will access to ssid)
 Configure blacklist based on SSID (When an entry exists in the black list, the corresponding client will be denied to access to ssid)

IV. Configuration Steps

Configure whitelist based on ssid:

```

WS5302(config)#wids
WS5302(config-wids)#ssid-filter whitelist mac-address 6809.27b0.169f in ruijie ----->6809.27b0.169f is
allowed to access to SSID: ruijie
WS5302(config-wids)#ssid-filter whitelist max 256----->adjust whitelist capacity (range from 1-256, optional
config)
  
```

Configure blacklist based on ssid:

```

WS5302(config)#wids
  
```

```
WS5302(config-wids)#static-blacklist ssid-mac 6809.27b0.169f in ruijie ----->6809.27b0.169f is denied to
access to SSID: ruijie
WS5302(config-wids)#ssid-filter blacklist max 256 ----->adjust blacklist capacity (range from 1-256, optional
config)
```

V. Verification

SSID: ruijie

1. When an entry exists in the white list, the corresponding client will access to ssid, STA MAC: (6809.27b0.169f, 8ca9.829a.b1ea)

```
WS5302#show wids ssid-filter whitelist in-ssid wireless ---check whitelist
----- filter white-mac List Information -----
num      mac          SSID
1        6809.27b0.169f wireless
WS5302#show ac-config client by-ap-name
===== show sta status =====
AP       : ap name/radio id
Status: Speed/Power Save/Work Mode, E = enable power save, D = disable power save

Total Sta Num: 1
STA MAC      IPV4 Address  AP                               Wlan  Vlan Status
Asso Auth Net Auth  Up time
-----
6809.27b0.169f 192.168.20.1 1414.4b13.c248/1                1     20 58.5M/E/bn  WPA2_PSK
0:01:42:11
```

2. When an entry exists in the black list, the corresponding client will be denied to access to ssid, STA MAC: (6809.27b0.169f, 8ca9.829a.b1ea)

```
WS5302#show wids ssid-filter blacklist in-ssid wireless ---check blacklist
----- filter black-mac List Information -----
num      mac          SSID
1        6809.27b0.169f wireless
WS5302#show ac-config client by-ap-name
===== show sta status =====
AP       : ap name/radio id
Status: Speed/Power Save/Work Mode, E = enable power save, D = disable power save

Total Sta Num: 1
STA MAC      IPV4 Address  AP                               Wlan Vlan Status
Asso Auth Net Auth  Up time
-----
```

```
8ca9.829a.b1ea 192.168.20.2    1414.4b13.c248/1    1    20    58.5M/D/bn
WPA2_PSK          0:00:10:24
```

4.4.3 Association Control

4.4.3.1 Association Control Working Principle

Overview

The association control is a method of controlling wireless STA's association behaviors. By grouping STAs, define one of the STAs as the master STA and others as secondary-STAs which must follow the master STA's method, and make the associated wireless network of secondary-STAs be the same as that of the master STA. Therefore, the associated behaviors of wireless terminals can be controlled.

Association control is usually used in the e-bag scenario.

Basic Concept

- 1) The association control zone: it can be understood as the wireless network made up of one or one group of APs. For a STA group, it can only successfully associate with a certain AP in an association control zone at one time.
- 2) The terminal package: it's made up of a group of STAs, including the master STA and secondary-STAs. Secondary-STAs cannot be separated from the master STA, associating with certain AP in the control zone alone. It can only follow the master STA; it can only associate with certain AP in the control zone with which the master STA associate.

Working Principle

Divide the scope of the wireless network into several association control zones, and arrange one or several APs in every association control zone, then group the wireless terminal to strictly control the control zones that the terminal can associate with. Take the application of the school e-bag for instance, a school has many classrooms in which wireless APs are installed and the wireless signal travels in the space. When two neighboring classrooms are using the e-bag, the ideal situation is that teachers' and students' computers all associate with local APs, therefore, every class can proceed without interruption. This requires each classroom to be an association control zone, and students' and teachers' computers all associate with local wireless APs.

I. Network Topology

The figure below shows the fit AP framework of the association control application.

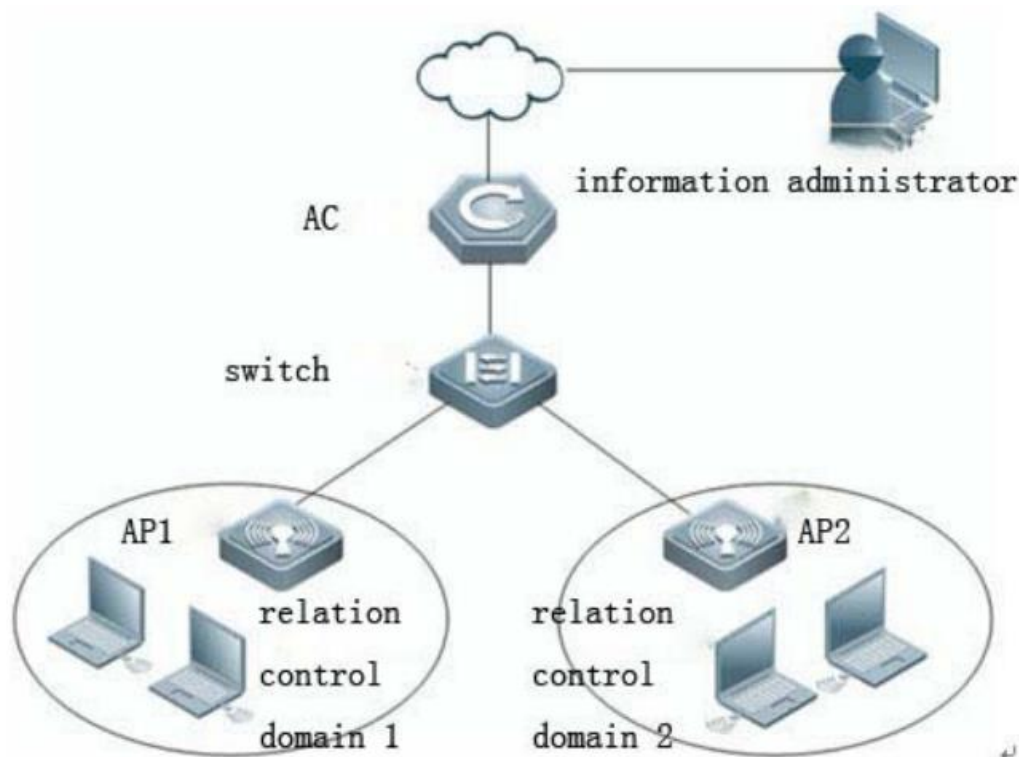

Fit AP networking topology

Premise

The purpose of the association control is to prevent the terminal to perform random associations when there are many wireless networks. The premise of the network configuration is as below:

- Set each association control zone as a WLAN subnet and allocate a VLAN for each subnet. By this measure, the broadcast or the multicast report is limited in the local control zone,.Thus, the application fluency of the association control zone is ensured.
- Use different SSIDs for all WLAN subnets. For example, use the association control zone's name as SSID for easier differentiation. It's easier for the master STA and secondary-STAs in the terminal to associate with designate APs in the association control zone.

Working Principle

- The AC sends all information of the master STA in the terminal package to all APs in the association control zone as per the pre-configured information of the association control zone and the terminal package.
- Since all the information of the master STA in the terminal package is on the AP's white list, when applying the association control function, the master STA needs to associate with corresponding SSIDs in the control zone first; after the master STA completes the association, the AC will send all secondary-STAs to all APs in the association control zone as per the configuration of the terminal package where the master STA stays, and create the white list, thus, secondary-STAs are allowed to be associated with the local control zone.
- When the master STA releases association and log off, all corresponding secondary-STAs will be offline and be deleted from the APs'white list in the association control zone.
- **The above process can be briefly summarized as that secondary-STAs follow the master STA; With whichever APs**

the master STA associates, secondary-STAs must follow and associate with the APs in the association control zone. The corresponding white list is only on the APs of the association zone, and since the list doesn't exist on APs in other association control zones. It ensures that STAs will not perform random associations.

Note: In the fit AP framework, the master STA and secondary-STAs might be distributed to several APs in certain control zones.

4.4.3.2 Association Control Configuration

Overview

The association control is a method of controlling wireless STA's association behaviors. By grouping STAs, define one of the STAs as the master STA and others as secondary-STAs which must follow the master STA's method, and make the associated wireless network of secondary-STAs be the same as that of the master STA. Therefore, the associated behaviors of wireless terminals can be controlled.

Association control is usually used in the e-bag scenario.

Only a wireless client access to the wireless network, and other wireless terminals can access the radio. Generally used in school teaching environment, such as students can access the wireless client only after a teacher connect to the wireless

Advantages: increase wireless security, ensure the use of the wireless network.

Disadvantages: a waste of radio resources, the need for additional configuration, can only be used in Fit mode.

I. Requirements

Secondary-sta will connect to wireless network if primary-sta is connected.

II. Network Topology

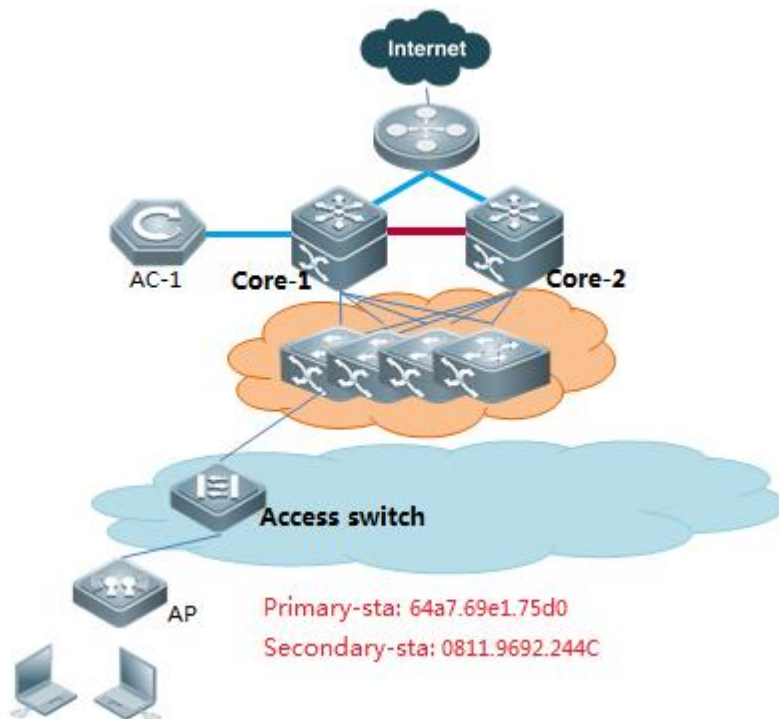

III. Configuration Tips

1. Configure the termination package
2. Configure the control zone
3. Enable the association control

IV. Configuration Steps

1. Configure termination package

```
AC-1(config)#package 5-2
```

```
AC-1(config-package)#primary-sta 64a7.69e1.75d0 ----->configure primary-STA
```

```
AC-1(config-package)#secondary-sta 0811.9692.244c ----->configure secondary-STA,add all secondary sta.
```

2. Configure control zone

```
AC-1(config)#control-zone js1----->control zone name is js1
```

```
AC-1(config-czone)#ap ap220-e ----->add relevant ap to the control zone
```

```
AC-1(config-czone)#ap ap220-i ----->add relevant ap to the control zone
```

```
AC-1(config)#control-zone js2
```

```
AC-1(config-czone)#ap ap320-1
```

```
AC-1(config-czone)#ap ap320-2
```

3. Enable associating control

```
AC-1(config)#assoc-control
```

4. Save config file

```
AC-1(config)#end
AC-1#write
```

V. Verification

1. Secondary-sta will connect to the wireless network if Primary-sta is connected.
2. AC show ac-config client, check sta online or not.

```
AC-1#show ac-config client
===== show sta status =====
AP : ap name/radio id
Status: Speed/Power Save/work Mode, E = enable power save, D = disable power save

Total Sta Num : 2
-----
STA MAC          IP Address      AP              wlan Vlan Status      Asso Auth Link Auth up time
-----
0811.9692.244c 172.16.10.2     ap220-e/1      1    10    117.0M/E/bn  Open    Open    0:00:00:17
64a7.69e1.75d0 172.16.10.7     ap220-e/1      1    10    13.0M/E/bn   Open    Open    0:00:01:04
```

3. Use command "show run" on AP, check the whitelist

```
wids
whitelist mac-address ffff.ffff.ffff
whitelist mac-address 64a7.69e1.75d0
whitelist mac-address 0811.9692.244c
```

4.4.4 DHCP Snooping + ARP-Check**Overview**

ARP check function filters all ARP packets on the logic interface and drops all illegal ARP packets, avoiding the ARP spoofing in the network and improving the network stability.

Ruijie switches support multiple IP security application (such as IP Source Guard, global IP+MAC binding, port security) which effectively filter the user IP packets and avoid the illegal user to use the network resources. The ARP check function generates the corresponding ARP filtering information according to the legal user information (IP or IP+MAC), implementing the illegal ARP packet filtering in the network.

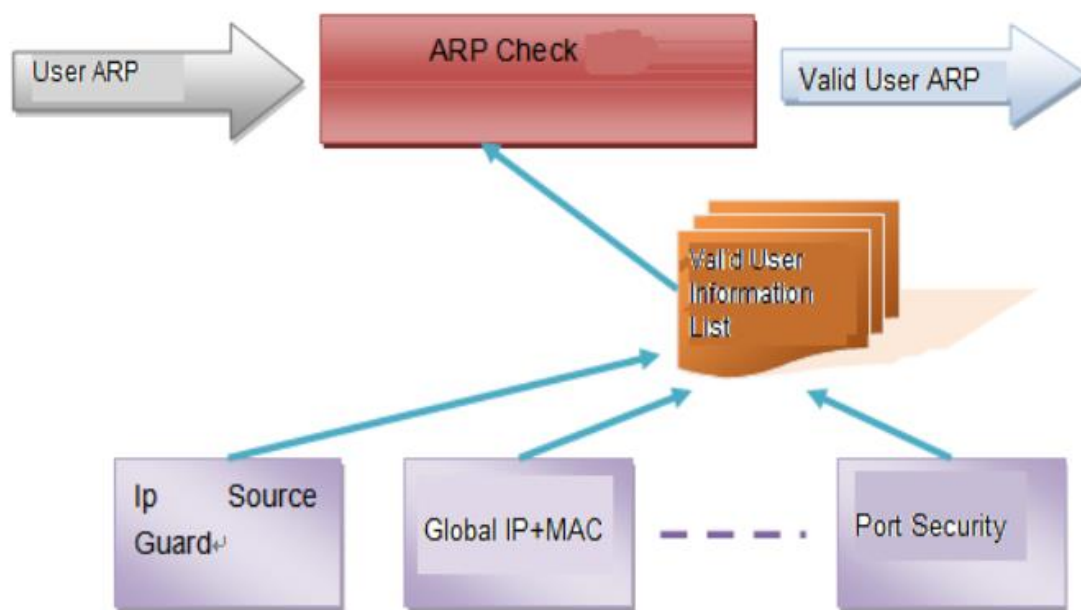

ARP check and other security function

ARP check function is enabled or disabled according to the current security function running state on the switch.

Enabling/disabling the following functions may trigger to enable/disable the ARP Check function:

- Global IP+MAC binding
- 802.1X IP authorization
- IP Source Guard
- GSN binding

Adding the legal user for the first time or removing the last legal user may trigger to enable/disable the ARP check function:

- IP+MAC binding mode for the port security
- IP-only mode for the port security

Note: ARP check is enabled no matter whether there is security configuration. If there is no legal user on the port, all the ARP packets from this port will be discarded.

DHCP Snooping and ARP Check

As with ARP Inspection, ARP Check checks all the ARP messages travelling through the switch. DHCP Snooping needs to offer the database information for ARP Check to use. After receiving an ARP message, the ARP Check-enabled switch queries the database bound by the DHCP Snooping. The ARP message is learned and forwarded only when its source MAC, source IP and port are matched or otherwise it is dropped.

II. Network Topology

AC loopback0:1.1.1.1/32

AP:192.168.20.0/24

STA:172.16.1.0/24

AC:192.168.1.0/24

STA vlan 10

AP vlan 20

AC vlan 30

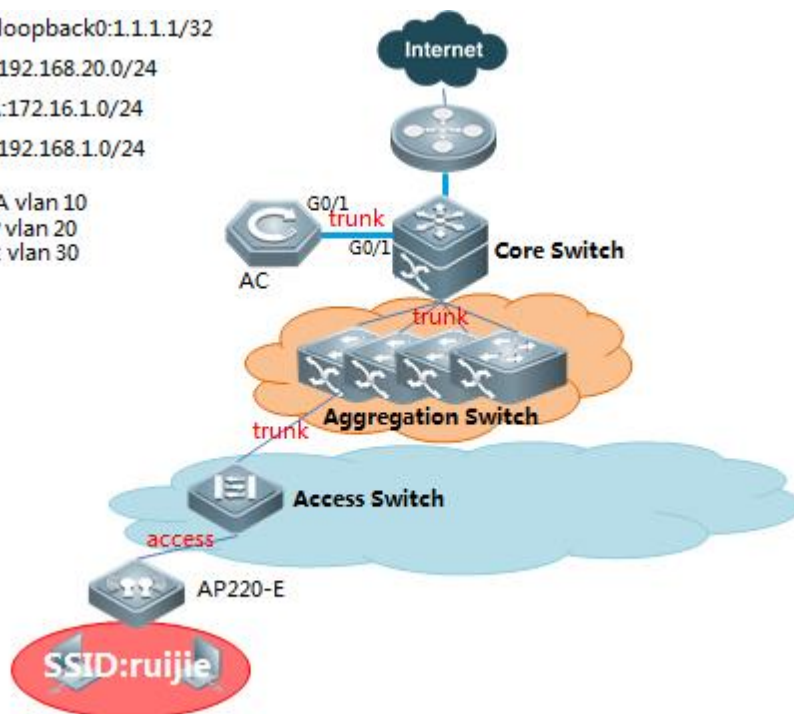

III. Configuration Tips

1. AC-1 enable dhcp snooping, configure uplink port as trust port
2. Configure arp-check
3. Clear arp and proxy arp table

IV. Configuration Steps

1. AC-1 enable dhcp snooping and configure trust port

```
AC-1(config)#ip dhcp snooping ----->enable dhcp snooping on config mode
```

```
AC-1(config)#interface gigabitEthernet 0/1
```

```
AC-1(config-if-GigabitEthernet 0/1)#ip dhcp snooping trust ----->set trust port
```

2. Configure arp-check (**note: sta reconnect to ap when arp-check enable**)

1) Scene1: **Without web-auth**

```
AC-1(config)#wlansec 1
```

```
AC-1(config-wlansec)#ip verify source port-security ----->enable ip source-guard
```

```
AC-1(config-wlansec)#arp-check ----->enable arp-check
```

2) Scene2: enable **web-auth**

```
AC-1(config)#web-auth dhcp-check ----->enable dhcp-check when enable web-auth
```

```
AC-1(config)#http redirect direct-arp 192.168.51.1 ----->must exclude STA's gateway arp packets
```

```
AC-1(config)#wlansec 1
```

```
AC-1(config-wlansec)#arp-check ----->enable arp-check
```

Note: when enable web-auth, configure anti-arp gateway spoofing to filter gateway arp spoofing:

1. Upgrade to RGOS11.x;
2. Config anti-arp gateway spoofing in wlansec mode.

```
AC-1(config)#wlansec 1
```

```
AC-1(config-wlansec)#anti-arp-spoofing ip 172.29.6.254 (172.29.6.254 represent user's gateway)
```

note: anti-arp-spoofing capacity is 64

3. Clear arp and proxy_arp table

```
AC-1#clear arp-cache
```

```
AC-1#clear proxy_arp
```

V. Verification

1. Wireless user ARP hardware binding info.

```
w56008#sh ip dhcp snooping binding
Total number of bindings: 2
-----
NO.      MACADDRESS      IPADDRESS      LEASE (SEC)    TYPE           VLAN  INTERFACE
-----
1        ec26.cae1.1999  172.29.6.138   86336          DHCP-Snooping  6     wlan 520
2        1475.90f9.42bd  172.29.6.141   86197          DHCP-Snooping  6     wlan 55
w56008#
```

2. Try manually ip setting, fails to ping gateway.

```
Administrator: Command Prompt - ping 172.29.6.254
Microsoft Windows [Version 6.1.7601]
Copyright (c) 2009 Microsoft Corporation. All rights reserved.

C:\Users\Administrator>ping 172.29.6.254

Pinging 172.29.6.254 with 32 bytes of data:

-
```

4.4.5 Countermeasure against Rogue AP

Overview

Compared with wired network, WLAN is convenient to deploy, flexible to use, cost-efficient and easy to expand, and is thus applied more and more widely. However, due to the openness of WLAN channel, the wireless networks are susceptible to a wide array of threats such as unauthorized APs, ad-hoc networks and different kinds of protocol attacks.

Therefore, security has become an important factor inhibiting the development of WLAN.

WIDS (Wireless Intrusion Detection System) provides early detection of malicious attacks and intrusions and helps the network administrator to proactively discover the hidden defects of network and take necessary countermeasures.

Currently, WIDS mainly provides the following features:

- Rogue device detection, countermeasure
- IDS attack detection
- Frame filtering (black list and white list)

User isolation

Basic concept of rogue device countermeasure:

Rogue device: Unauthorized or malicious device on the network. It can be an illegal AP, illegal bridge or unauthorized Ad-hoc device.

Rogue AP: An unauthorized or malicious AP on the network, such as an unauthorized AP, misconfigured AP or an attacker operated AP.

Rogue AP Countermeasure is used to attack fake authentication release frame sent by rogue AP address in the list to countermeasure rogue AP.

I. Requirements

Monitor Rogue AP and configure countermeasures.

II. Network Topology

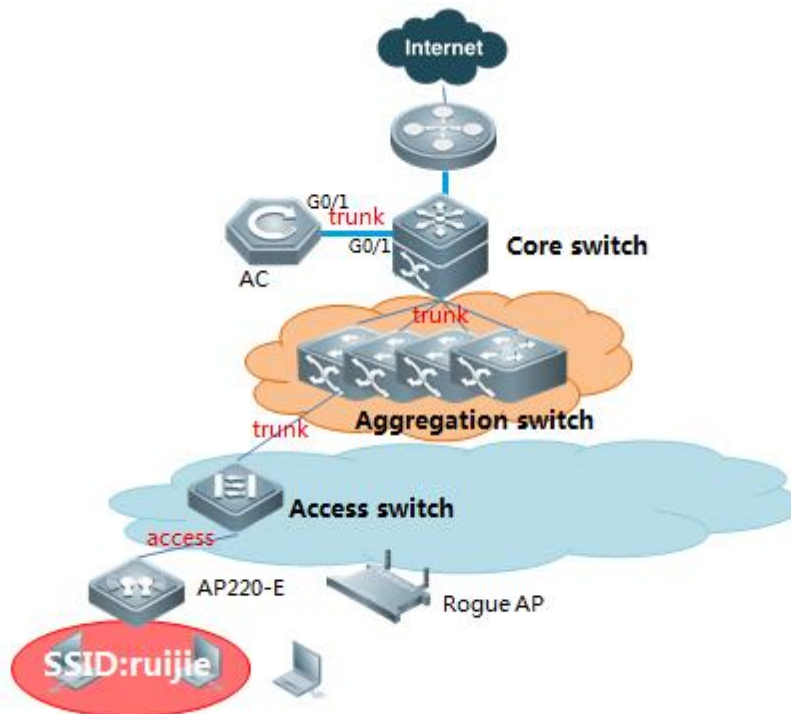

III. Configuration Tips

1. Configure device mode
2. Configure countermeasure

IV. Configuration Steps

1. Configure AP as monitor or hybrid mode

```
AC(config)# ap-config ap220-e
AC(ap-config)# device mode monitor    or    AC(ap-config)# device mode hybrid
```

Note:

Monitore mode: monitor/attack rogue AP only

Hybrid mode: monitor/attack rogue AP and forward user date as normal AP (less monitor performance)

2. Configure countermeasure rogue ap static list

Firmware version 11.X:

```
AC (config)#ap-config AP220-I ----->enter ap-config mode
AC(config-ap)#device mode monitor
AC(config-ap)#scan-channels 802.11b channels 1 2 3 4 5 6 7 8 9 10 11 12 13 --->configure the scanning
channel of 2.4G
AC(config-ap)#scan-channels 802.11a channels 149 153 157 161 165 --->configure the scanning channel of
5G
AC(config)#wids ----->enter wids mode
AC(config-wids)#countermeasure enable ----->enable countermeasure
AC(config-wids)#countermeasures channel-match ----->enable channel-based containment
AC(config-wids)#countermeasures mode config ----->choose the countermeasures mode
AC(config-wids)#device attack mac-address 061b.b120.700c ----->add static list of attack, add rogue AP
bssid:061b.b120.700c. you can scan rogue AP with wirelessmon to confirm the bssid.
```

Appendix:

Base on the circumstance that AP740-I has three RF cards, we can use radio 1 and radio 2 for wifi service, and use radio 3 to countermeasure other rouge aps. The graphic configurations are shown below:

```
AC (config)#ap-config AP740-I ----->entwe into the specific ap
AC (config-ap)#radio-type 3 802.11b ----->config the third RF card to be 2.4g
AC (config)#ap-config AP740-I ----->enter ap-config mode
AC(config-ap)#device mode monitor radio 3 ----->choose the radio 3 to be the countermeasure role
AC(config-ap)#scan-channels 802.11b channels 1 2 3 4 5 6 7 8 9 10 11 12 13 --->configure the scanning
channel of 2.4G
AC(config-ap)#scan-channels 802.11a channels 149 153 157 161 165 --->configure the scanning channel of
5G
AC(config)#wids ----->enter wids mode
AC(config-wids)#countermeasure enable ----->enable countermeasure
AC(config-wids)#countermeasures channel-match ----->enable channel-based containment
AC(config-wids)#countermeasures mode config ----->choose the countermeasures mode
AC(config-wids)#device attack mac-address 061b.b120.700c ----->add static list of attack, add rogue AP
bssid:061b.b120.700c. you can scan rogue AP with wirelessmon to confirm the bssid.
```

Countermeasure mode concept:

Use this command to configure the device countermeasures mode. Use the no form of this command to restore the default setting.

```
countermeasures mode { all | adhoc | config | rogue | ssid }
```

```
no countermeasures mode { all | adhoc | config | rogue | ssid }
```

Parameter	Description
all	Indicates all countermeasures are enabled.
ssid	Indicates the devices with the same SSID on the AP are subjected to the countermeasures.
rogue	Indicates only detected rogue devices are subjected to the countermeasures.
adhoc	Indicates only detected adhoc devices are subjected to the countermeasures.
config	Indicates only the devices configured in the static attack list are subjected to the countermeasures.

Optional configuration: (You can use below commands when countermeasure is inefficient)

1. Unknown STA Detection (unicast countermeasure).

```
Ruijie#configure terminal
Ruijie(config)#wids
Ruijie(config-wids)#device unknown-sta dynamic-enable ----->enable the unknown STA detection and
containment function
Ruijie(config-wids)#device unknown-sta mac-address 1234.1234.1234----->configure the unknown STA list
entry
```

2. Add an entry to the permissible list

```
Ruijie#configure terminal
Ruijie(config)#wids
Ruijie(config-wids)# device permit mac-address 1234.1234.1236----->configure the permissible MAC list
1234.1234.1236
Ruijie(config-wids)# device permit ssid test----->configure the permissible SSID list test
Ruijie(config-wids)# device permit vendor bssid 1234.1234.1236----->configure the permissible vendor list
```

3. Configure countermeasure parameters

```
Ruijie#configure terminal
Ruijie(config)#wids
Ruijie(config-wids)#countermeasures interval 2000-----> configure countermeasures interval 2000ms
Ruijie(config-wids)#countermeasures ap-max 256---> configure the maximum number of contained devices
once,ranging from 1 to 256. The default maximum number of countered devices is 30.
Ruijie(config-wids)#countermeasures rssi-min 5 --->configure the minimum containment RSSI,ranging from
0 to 75(This value is not recommended to set too small)
```

```
Ruijie(config-wids)#device detected-ap-max 100 --->configure the maximum number of detected APs,ranging from 1 to 4096.
Ruijie(config-wids)#device aging duration 1000 --->configure the aging duration of the detected devices,ranging from 500 to 5000 seconds.
```

V. Verification

Wireless users can not connect to rogue APs or packets loss.

4.4.6 User Isolation

Overview

Enable the isolation function in the wireless device (the AP or the AC). When the device receives a certain user's report, it will judge if it's the same device according to the resource port and the destination port in the information it forwards. If the resource port and the destination port are on the same device, then discard the report; Otherwise, normally forward the report. The user can also add the permitted interflow user table entry through configuring isolation permit list. If the MAC address of two users on the same AP or AC is added into the user isolation permit list, then these two users can visit each other.

The process of enabling the user isolation function is showed in the picture below:

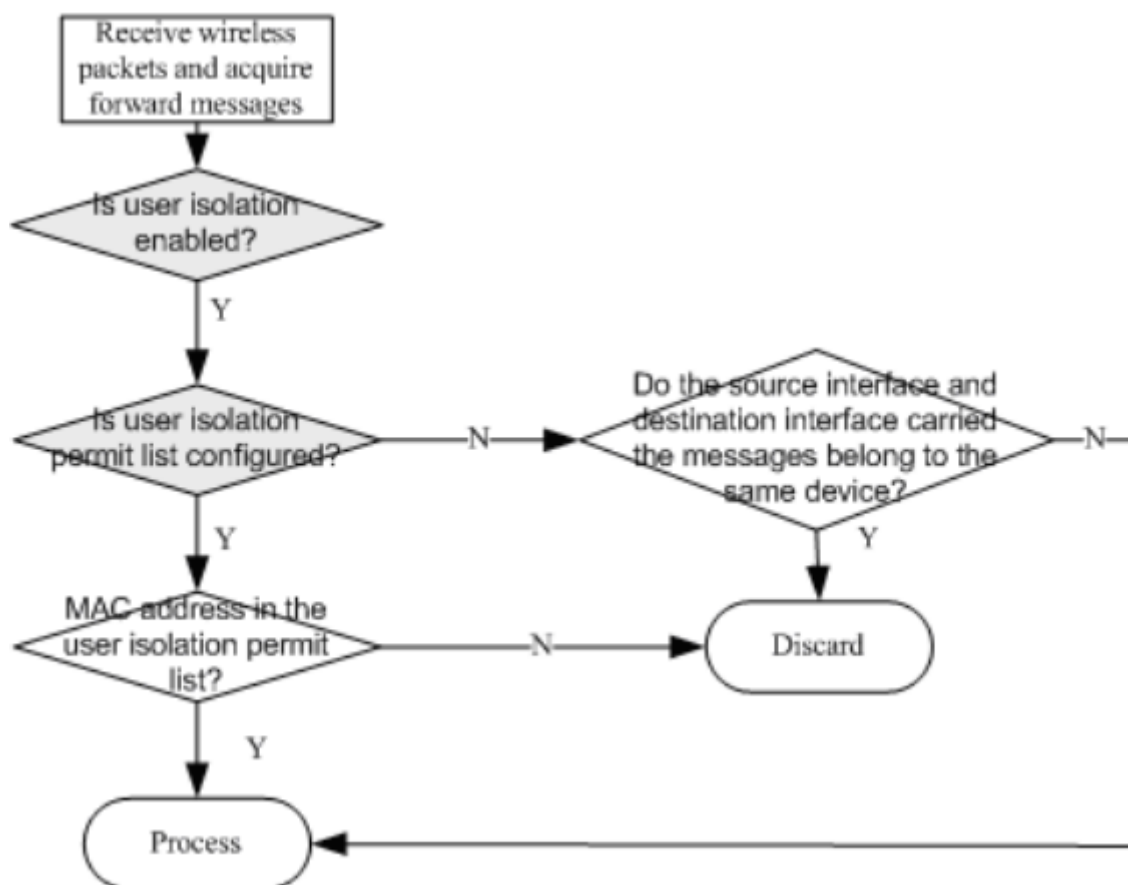

I. Requirements

To protect user data, network administrator usually isolate traffic between STA connected to the same AP/AC/SSID

II. Network Topology

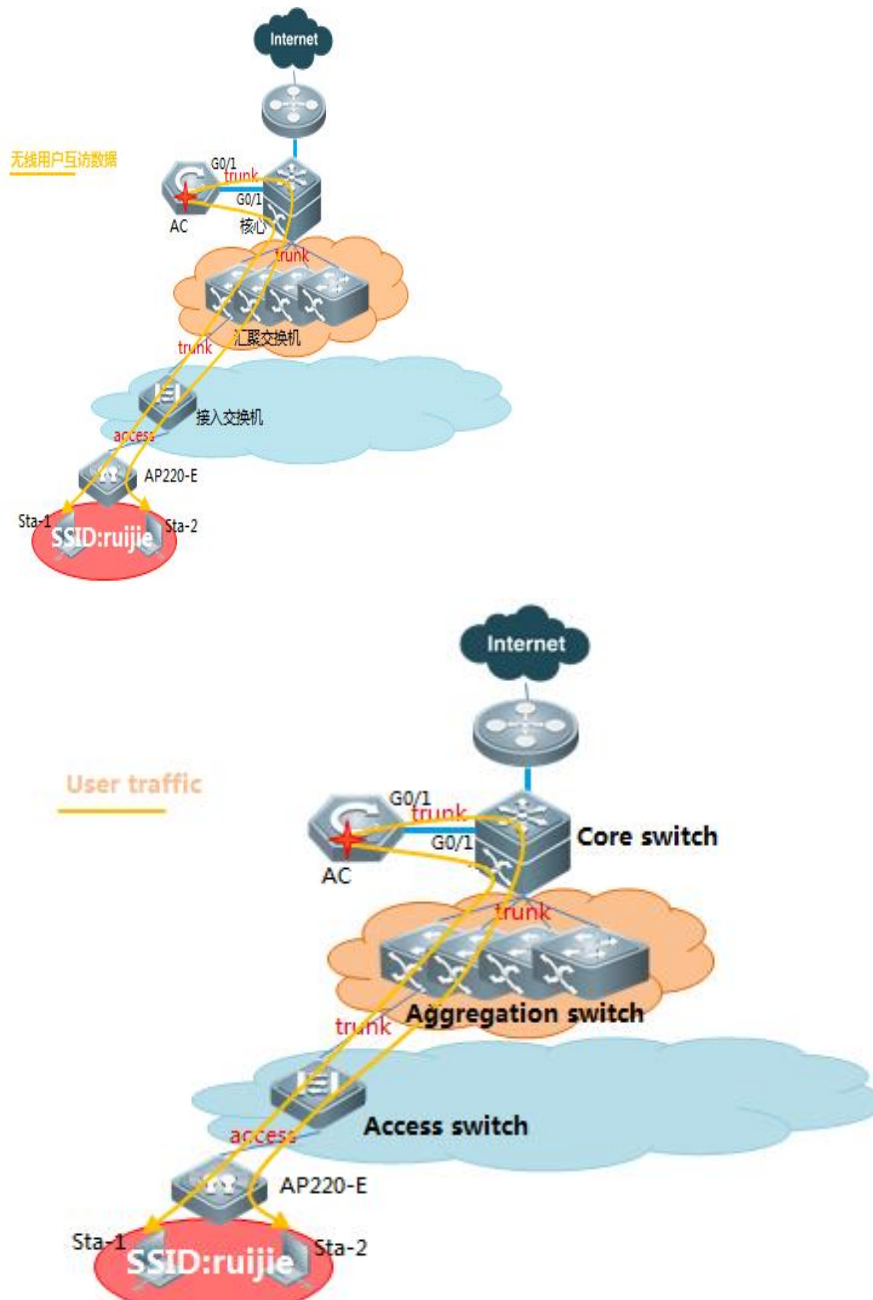

III. Configuration Tips

- 1) Enable user isolation

- 2) Define isolation mode
- 3) Define permit-mac

IV. Configuration Steps

Fit AP configuration

1. Isolation types: per-AC isolation, per-AP isolation, per AC-SSID isolation, per AP-SSID isolation:

- 1) Isolate user associated to the same AC

```
AC(config)#wids
```

```
AC(config-wids)#user-isolation ac enable
```

- 2) Isolate user associated to the same AP

```
AC(config)#wids
```

```
AC(config-wids)#user-isolation ap enable
```

- 3) isolate user associated to the same AC+SSID

```
AC(config)#wids
```

```
AC(config-wids)#user-isolation ssid-ac enable
```

- 4) isolate user associated to the same AP+SSID

```
AC(config)#wids
```

```
AC(config-wids)#user-isolation ssid-ap enable
```

2. Configure permit mac, user in permit-mac list, will be unrestricted.

```
AC(config)#wids
```

```
AC(config-wids)#user-isolation permit-mac 0811.9692.244c
```

Note: User Isolation feature is only for L2 user isolation

Fat AP configuration

1. Isolation types: per-AP isolation, per AP-SSID isolation

- 1) Isolate user associated to the same AP

```
Ruijie(config)#wids
```

```
Ruijie (config-wids)#user-isolation ap enable
```

- 2) Isolate user associated to the same AP+SSID

```
Ruijie (config)#wids
```

```
Ruijie (config-wids)#user-isolation ssid-ap enable
```

2. Configure permit mac, user in permit-mac list, will be unrestricted.

```
AP(config)#wids
```

```
AP(config-wids)#user-isolation permit-mac 0811.9692.244c
```

Note: User Isolation feature is only for L2 user isolation

V. Verification

1. WIFI users are isolated from other local STA
2. User in permit-MAC list is allowed to communicate with others.

4.4.7 Conceal SSID (Disable SSID Broadcast)

Overview

On the WLAN, the AP periodically broadcasts the SSID information to notify other entities of the existence of the wireless network. Wireless users use the wireless network interface cards (NICs) to search SSIDs and detect the wireless network. The SSID broadcasting function can be enabled to prevent the wireless network from being searched and connected by unauthorized users based on the SSID.

Configure Conceal SSID:

For Fit AP, configuring on AC

```
AC(config)#wlan-config 1 conceal
AC(config-wlan)#no enable-broad-ssid      ---> disable SSID broadcast
AC(config)#ap-group default
AC(config-group)#no interface-mapping 1 1  --->online user will be forced offline
AC(config-group)#interface-mapping 1 1    ---> map wlan-id to vlan-id again
AC(config-group)#end
AC#write
```

For Fat AP, configuring on AP

```
FatAP(config)#dot11 wlan 1
FatAP(dot11-wlan-config)#no broadcast-ssid ---> disable SSID broadcast
FatAP(config)#interface dot11radio 1/0
FatAP(config-if-Dot11radio 1/0)#no wlan-id 1 --->online user will be forced offline
FatAP(config-if-Dot11radio 1/0)#wlan-id 1 ---> map wlan-id to vlan-id again
```

Verification:

Your wireless client should be unable to search this wlan, and you need to join this wlan manually.

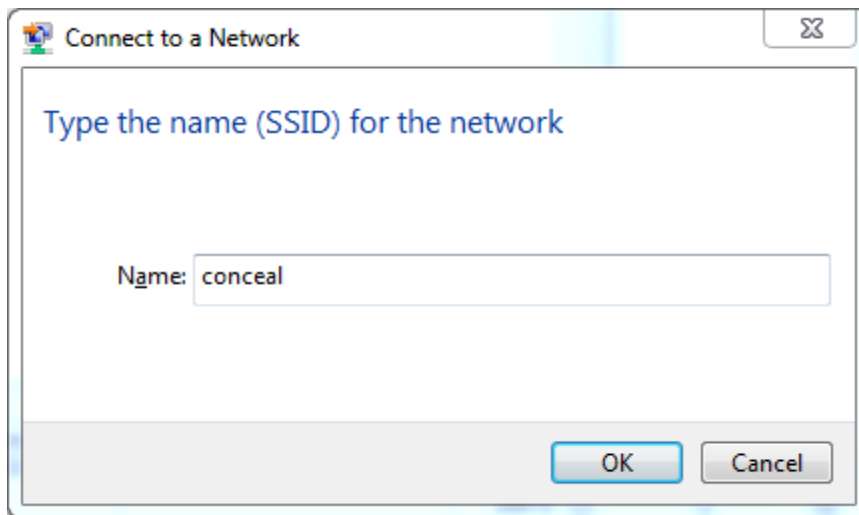
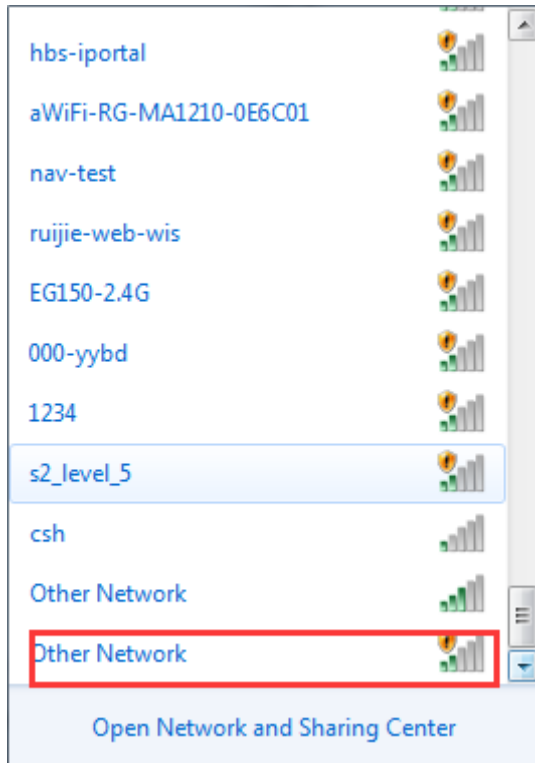

4.4.8 FAQ

4.4.8.1 Will own Ruijie APs be countered if the wireless AP countering is enabled?

No in fit mode but yes in fat mode.

The beacon frame contains a friendly flag which is used to judge whether the AP is a friendly AP. **If the APs are all associated with the Ruijie AC, the friendly flags are the same by default, and Ruijie APs are not countered. When the friendly flags are modified to be different, countering is enabled for APs on Ruijie AC.** By default, the friendly flag for all Ruijie APs is the same and thus Ruijie APs are not deemed as rogue APs. The configuration method of the friendly flag is as follows:

```
Ruijie(config-wids)#device friendly-flags ?
<1-4294967295> 1 ~ 4294967295
```

4.4.8.2 How to display rogue APs?

Run the **show wids detected rogue ap** command.

```
WuLiu-WS5708#sh wids detected rogue ap
----- Rogue AP Information -----
SSID          BSSID          CHAN    RATE    S:N
RGWLAN_IT13_wireless  021a.a9c5.8931  157    54.0M   15:0
```

4.4.8.3 How to display all SSID in the environment?

Run the **show wids detected all** command.

```
WuLiu-WS5708#sh wids detected all
----- DETECTED ADHOC Information -----
SSID          BSSID          CHAN    RATE    S:N
----- DETECTED AP Information -----
SSID          BSSID          CHAN    RATE    S:N
vlan41        0627.1d05.2680  1       18.0M   37:0
chenfang_cf668_ssid50  061b.b18e.394b  1       18.0M   35:0
2b15-mib      061b.b120.58e0  1       18.0M   57:0
2b15-mib      d21a.a9c1.ec9e  1       54.0M   63:0
RGWLAN_IT13_wireless  061b.b120.6916  1       54.0M   26:0
RGWLAN_IT13_wireless_1X  0a1b.b120.6916  1       54.0M   26:0
wcy1234567    5c63.bf3e.c8a2  1       18.0M   19:0
LO1           001a.a9c1.eae4  1       54.0M   52:0
fanqx-fat-ap2.0  321a.a9c1.e7c4  1       54.0M   83:0
wxw_cmcc_612  42d0.f822.33b0  1       54.0M   18:0
wxw_cmcc_601  42d0.f822.33b5  1       54.0M   20:0
lulihua_2t106  8614.f822.33bb  1       54.0M   22:0
icbc_ruijie   061b.b122.364e  1       18.0M   15:0
RGWLAN_2B15_iphone  061b.b120.67b8  1       36.0M   33:0
```

4.4.8.4 How to judge whether an AP is under countering?

1. Symptom

Users in Building 12 in old campus cannot be associated with China UNICOM-WLAN SSID. Users associated with this SSID are often disconnected and cannot visit the Internet.

Onsite Problem Locating:

In the dormitory with poor user experience, we found that after the computer is connected to China UNICOM-WLAN SSID, the SSID signal often disappears, the ping packet loss rate is high, and the computer is often disconnected from the Internet.

2. Possible Cause

The AP countering function is configured.

3. Troubleshooting Steps

We used a professional tool (Ominpeek) to capture packets in the corridor on the second floor. A great amount of deauthentication (Death) packets were found, as shown in Figure 1. We located the AP (MAC address: 9614 4B1B 34FA) of the broadcast Death packet and found that it is an AP of China Unicom. After searching on the AC, we found that the i-Share AP was deployed here, covering the surrounding six rooms. But the log shows that the AP does not send any Death packet. Then it is confirmed that it is not this AP that sends the invalid Death packet.

After analysis, we suspected that there was a rogue AP. The rogue AP sent dissociated Death packets to the associated users in the name of China UNICOM AP, as shown in Figure 2. According to signal strength comparison, the signal strength of normal packet was about 26%, while that of the Death packet sent by the rogue AP was 100%, as shown in Figure 3. Therefore, we confirmed the existence of the rogue AP and knew that the rogue AP was close to the test place, resulting in frequent disconnection of users within the coverage of this rogue AP from the WLAN.

Figure 1: Too many Death packets

Protocol	Percentage	Bytes	Packets
802.11 Ack	.607%	86,158	6,145
802.11 RTS	.749%	106,280	5,314
UDP	9.279%	1,317,282	2,243
802.11 Beacon	2.275%	322,894	2,031
802.11 Deauth	.239%	33,928	1,131
802.11 CTS	.069%	9,793	687
802.11 Probe Rsp	.617%	87,550	555

Figure 2: The rogue AP broadcasting Death packets in the name of China UNICOM MAC

6053	96:14:4B:1B:34:FA	Ethernet Broadcast	96:14:4B:1B:34:FA	*	11	100%	1.0	30	0.774114	3.956366	802.11 Deauth
6999	96:14:4B:1B:34:FA	Ethernet Broadcast	96:14:4B:1B:34:FA	*	11	100%	1.0	30	0.803632	4.759998	802.11 Deauth
9038	96:14:4B:1B:34:FA	Ethernet Broadcast	96:14:4B:1B:34:FA	*	11	100%	1.0	30	1.591501	6.351499	802.11 Deauth
11447	96:14:4B:1B:34:FA	Ethernet Broadcast	96:14:4B:1B:34:FA	*	11	100%	1.0	30	1.560242	7.911741	802.11 Deauth
13899	96:14:4B:1B:34:FA	Ethernet Broadcast	96:14:4B:1B:34:FA	*	11	100%	1.0	30	1.536886	9.448627	802.11 Deauth
15367	96:14:4B:1B:34:FA	Ethernet Broadcast	96:14:4B:1B:34:FA	*	11	100%	1.0	30	0.835872	10.284499	802.11 Deauth
16365	96:14:4B:1B:34:FA	Ethernet Broadcast	96:14:4B:1B:34:FA	*	11	100%	1.0	30	0.815100	11.099599	802.11 Deauth
17712	96:14:4B:1B:34:FA	Ethernet Broadcast	96:14:4B:1B:34:FA	*	11	100%	1.0	30	0.799638	11.899237	802.11 Deauth
18986	96:14:4B:1B:34:FA	Ethernet Broadcast	96:14:4B:1B:34:FA	*	11	100%	1.0	30	0.770739	12.669976	802.11 Deauth
19028	96:14:4B:1B:34:FA	Ethernet Broadcast	96:14:4B:1B:34:FA	*	11	100%	1.0	30	0.024885	12.694861	802.11 Deauth
20098	96:14:4B:1B:34:FA	Ethernet Broadcast	96:14:4B:1B:34:FA	*	11	100%	1.0	30	0.755135	13.449996	802.11 Deauth

Figure 3: Signal length of normal packets lower than that of Death packets

122	96:14:4B:1B:34:FA	Ethernet Broadcast	96:14:4B:1B:34:FA	*	11	13%	24.0	162	0.100250	0.100250	802.11 Beacon
139	96:14:4B:1B:34:FA	Ethernet Broadcast	B8:46:96:6B:67:64	CW	11	0%	24.0	34	0.032784	0.133034	802.11
429	96:14:4B:1B:34:FA	Ethernet Broadcast	96:14:4B:1B:34:FA	*	11	23%	24.0	162	0.274487	0.407521	802.11 Beacon
585	96:14:4B:1B:34:FA	Ethernet Broadcast	96:14:4B:1B:34:FA	*	11	26%	24.0	162	0.102387	0.509908	802.11 Beacon
598	96:14:4B:1B:34:FA	Ethernet Broadcast	96:14:4B:1B:34:FA	*	11	100%	1.0	30	0.009490	0.519398	802.11 Deauth
703	96:14:4B:1B:34:FA	Ethernet Broadcast	96:14:4B:1B:34:FA	*	11	26%	24.0	162	0.092876	0.612274	802.11 Beacon
716	96:14:4B:1B:34:FA	Ethernet Broadcast	00:1E:4C:8D:93:55	*	11	26%	1.0	156	0.011125	0.623399	802.11 Probe Rsp
717	96:14:4B:1B:34:FA	Ethernet Broadcast	96:14:4B:1B:34:FA	**	11	26%	1.0	156	0.001753	0.625152	802.11 Probe Rsp
722	96:14:4B:1B:34:FA	Ethernet Broadcast	00:1E:4C:8D:93:55	**	11	26%	1.0	156	0.003485	0.628637	802.11 Probe Rsp

4. Collecting the Fault Information

Locating the Rogue AP

During onsite survey, we found an AP of another carrier near the test place and the data light of this AP flashed very fast, indicating transmission of a great amount of data. This AP was suspected to be a rogue AP.

To confirm it, we powered off this AP and captured packets at the air interface on site. The result showed that the percentage of death packets decreased immediately from 0.239% to 0.031%, as shown in Figure 4.

Figure 4: Decreasing of death packets after the rogue AP is powered off

Protocol	Percentage	Bytes	Packets
802.11 Ack	.371%	56,644	4,046
UDP	17.039%	2,600,100	3,177
HTTP	18.050%	2,754,428	2,434
802.11 CTS	.139%	21,168	1,512
802.11 Beacon	1.156%	176,443	1,059
802.11 BA	.182%	27,778	817
802.11 RTS	.099%	15,100	755
HTTPS	.609%	92,858	343
Null SAP	.370%	56,411	335
802.11 Probe Rsp	.208%	31,742	187
ICP	.939%	143,217	182
802.11 Deauth	.031%	4,800	160
802.11 Null Data	.013%	2,044	73
DNS	.057%	8,700	65

Then, the users can be associated with the AP and access the WLAN. No ping packet is lost.

After the carrier's AP is restored, the problem occurs again. Therefore, it can be confirmed that the carrier's AP is a rogue AP and the AP countering function is enabled.

4.5 WLAN Roaming

4.5.2 Layer-2 Inter-AC Roaming Configuration

Scenario

When a STA (station, wireless workstation) roams to the coverage edge of two adjacent APs, STA will associate with the new AP and disconnect from the original AP, and uninterrupted network connection is maintained during this process. Inter-AC Roaming need to establish mobility group between two AC in order to interaction data and ensure that users roam without perception.

I. Requirements

AP1 and AP2 establish CAPWAP with different AC in fit mode. STA need roaming from

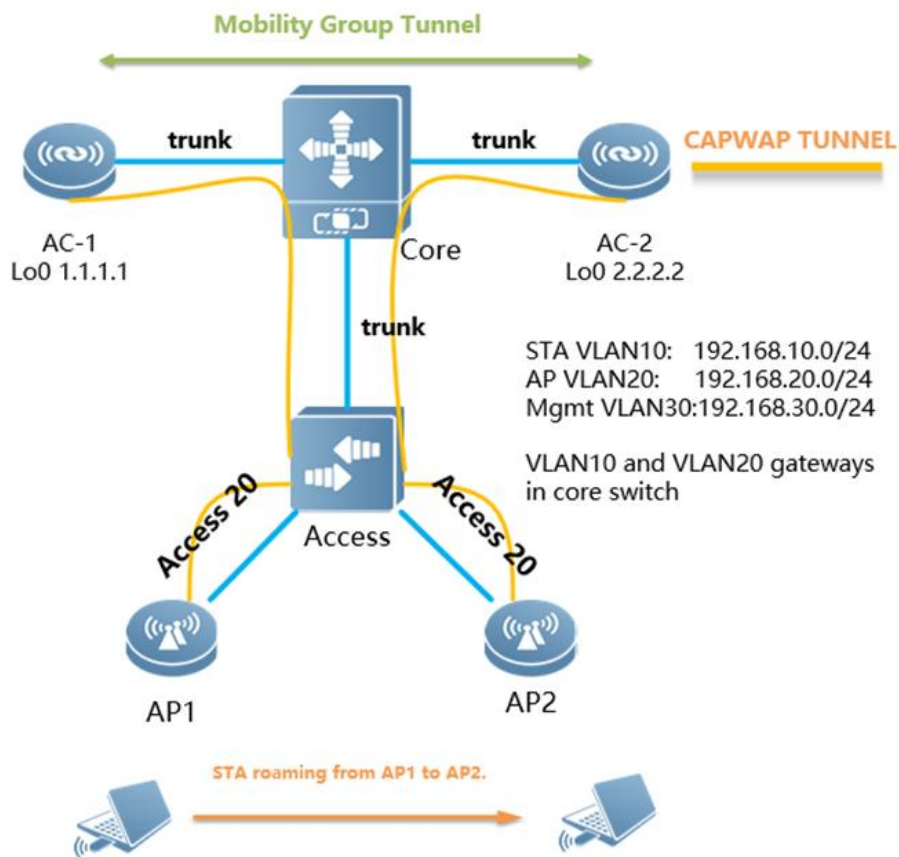

AP1 to AP2.

II. Configuration Steps

Before configure roaming, please make sure that the network deployment has been completed, the data communication is normal.

1. Configure ip route and make AC-1 and AC-2 are reachable

Core Switch:

```
core(config)#ip route 1.1.1.1 255.255.255.255 192.168.30.2
core(config)#ip route 2.2.2.2 255.255.255.255 192.168.30.3
```

AC-1:

```
AC-1(config)#ip route 0.0.0.0 0.0.0.0 192.168.30.1 ---->192.168.30.1 is the address of core switch
```

AC-2:

```
AC-2(config)#ip route 0.0.0.0 0.0.0.0 192.168.30.1
```

2. Configure mobility group

AC-1:

```
AC-1(config)#mobility-group mgroup_name ---->configure mobility group,named mgroup_name
```



```
AC-1(config-mobility)#member 2.2.2.2 ---->configure mobility group members(Peer AC's loopback0)
```

AC-2:

```
AC-2(config)#mobility-group mgroup_name
AC-2(config-mobility)#member 1.1.1.1
```

3. Log shows tunnel built successfully

AC-2#*Feb 25 19:59:35: %LINEPROTO-5-UPDOWN: Line protocol on Interface Mobile-Tunnel 1, changed state to up

III. Verification

1. Use "show mobility summary" to check mobility state on AC

```
AC-1#show mobility summary
Mobility Group mgroup_name
Mobility Keepalive Interval..... 10
Mobility Keepalive Count..... 4
Mobility Group Status..... Normal

Mobility Members:
IP Address      Client/Server  Data Tunnel   Ctrl Tunnel
2.2.2.2        Client         OK            OK
```

2. Use ping to confirm the roaming process when STA connects to AP1 and moves to AP2

1) Use "show ac-config client detail" on AC-1 to check STA state before roaming (local means non-roaming).

```
AC1#show ac-config client detail 54ae.2781.d498
Mac Address      :54ae.2781.d498
IP Address       :192.168.10.2
Wlan Id         :1
Vlan Id         :10
Roam State       :Local ---->non-roaming user
Security Attribute :Normal

Associated Ap Information:
AP Name         :b8fd.3200.3aa3
AP IP           :192.168.20.3
```

2) Use ping to confirm the roaming process when STA connects to AP1 and moves to AP2

```
C:\Users\Administrator>ping 172.29.6.254 -t

Pinging 172.29.6.254 with 32 bytes of data:
Reply from 172.29.6.254: bytes=32 time=7ms TTL=64
Reply from 172.29.6.254: bytes=32 time=4ms TTL=64
Reply from 172.29.6.254: bytes=32 time=2ms TTL=64
Reply from 172.29.6.254: bytes=32 time=8ms TTL=64
Reply from 172.29.6.254: bytes=32 time=4ms TTL=64
Reply from 172.29.6.254: bytes=32 time=14ms TTL=64
Reply from 172.29.6.254: bytes=32 time=4ms TTL=64
Reply from 172.29.6.254: bytes=32 time=2ms TTL=64
Reply from 172.29.6.254: bytes=32 time=1ms TTL=64
Reply from 172.29.6.254: bytes=32 time=3ms TTL=64
Reply from 172.29.6.254: bytes=32 time=3ms TTL=64
Reply from 172.29.6.254: bytes=32 time=9ms TTL=64
Reply from 172.29.6.254: bytes=32 time=1ms TTL=64
Request timed out.
Reply from 172.29.6.254: bytes=32 time=30ms TTL=64
Reply from 172.29.6.254: bytes=32 time=1ms TTL=64
Reply from 172.29.6.254: bytes=32 time=3ms TTL=64
Reply from 172.29.6.254: bytes=32 time=2ms TTL=64
Reply from 172.29.6.254: bytes=32 time=1ms TTL=64
Reply from 172.29.6.254: bytes=32 time=1ms TTL=64
```

(only one packet loss during roaming)

- 3) Use "show ac-config client detail" on AC-2 after roaming to confirm roaming state.(Roam means roaming successfully)

```
AC2#show ac-config client detail 54ae.2781.d498
Mac Address      :54ae.2781.d498
IP Address       :192.168.10.2
Wlan Id         :1
Vlan Id         :10
Roam State      :Roam ---->roaming user
Security Attribute :Normal

Associated Ap Information:
AP Name         :1414.4b65.3cf0
AP IP           :192.168.20.2
```

5 Advanced Features

5.1 Band Select

5.1.1 Understanding Band Select

Overview

The major communication band of IEEE802.11 is divided into two parts:

2.4GHz (2.4 to 2.4835 GHz), where the 802.11b/g/n band is at;

5GHz (5.15 to 5.35 and 5.725 to 5.825 GHz), where the 802.11a/n band is at.

With the popularity of WLAN, there come more and more wireless users, many of whom use dual-band STAs which can simultaneously support the 2.4G band and the 5G band. However, 802.11b/g enjoys more popularity than 802.11a so that many dual-band STAs unanimously use the 2.4 G band, resulting in a crowded 2.4 G band and a wasted 5G band. In fact, the 5G band has a higher access capacity while the 2.4G band can only have a maximum of three non-overlapping communication channels; moreover, the 5G band is able to provide more non-overlapping communication channels, five in China, and up to 24 in North America.

Band Select uses technical means to guide the dual-band STAs to be connected to the 5G band which has higher access capacity so as to reduce the pressure on the 2.4G band and enhance the user experience.

Band Select workflow

Commonly, without Band Select, STAs send probe frames (broadcast) on all the communication channels of all its supporting bands, and the probe frame contains the information such as the wireless access speed that STAs support and etc.; once APs which provide WLAN access services received the probe frame, APs will send out probe responses, providing some information of the WLAN that they provide to STAs; STAs usually aggregate all responses they receive and present a list of accessible WLANs to the users so that they could choose which WLAN to access.

The following figure shows the process of an STA detecting the accessible WLANs that provided by a dual-band AP. After the process is finished, the STA would detect two BSSIDs with two bands belonging to the same WLAN, but the user is unable to discern between them since their SSIDs are the same. If the user selects this WLAN for access, then the choice of two bands depends on the user's wireless driver and it is an uncontrollable factor for both the user and the AP.

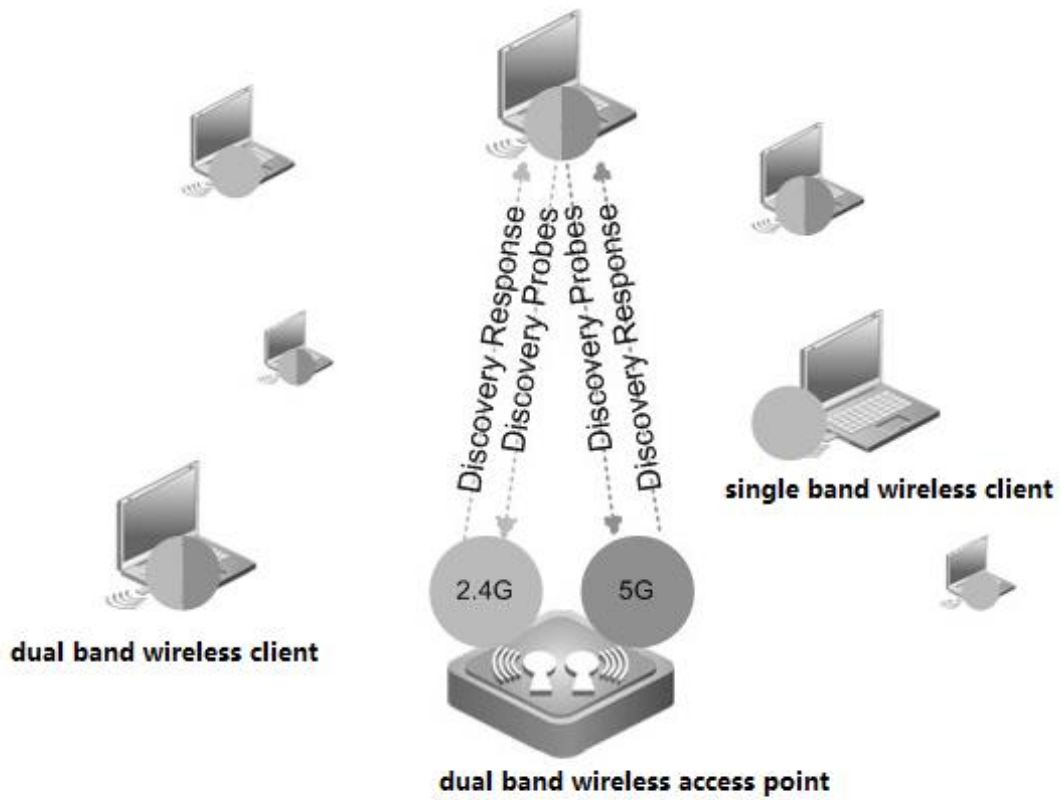

With Band Select, it guides STAs to select the 5G band in priority. As shown in below diagram, in comparison with above diagram, AP doesn't response to the 2.4G band.

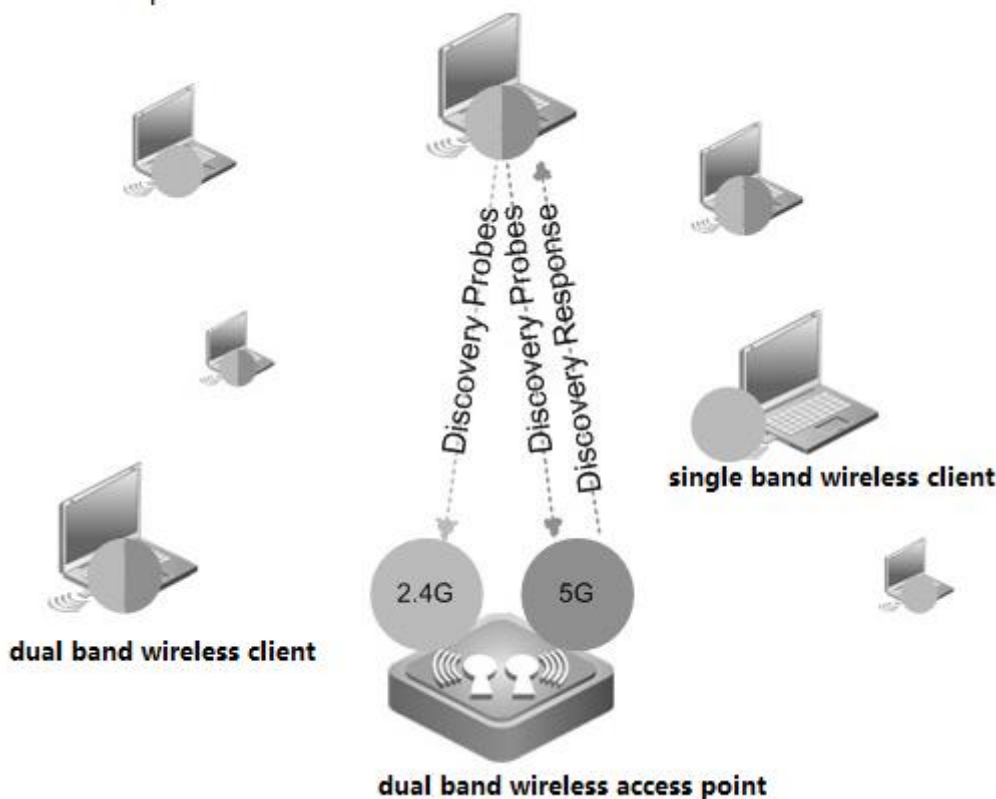

Attention: The Band Select can only work on dual-band APs; it is meaningless to use it on single-band APs.

Band Select Side Effect

Because APs do not respond to the probe request on the 2.4G band before recognizing STAs, this will lead to the fact that STAs with single-band 2.4G are unable to detect WLAN before being recognized by APs. This period of time is 20 seconds, which means that STAs with single-band 2.4G STA may not detect the accessible WLAN within 20 seconds.

Assuming the time it takes to refresh a WLAN list is 7 seconds, then the worst case is that users of STAs with single-band 2.4G are unable to see the accessible WLAN until the third time of refreshing the WLAN list; generally, if a user of STAs with single-band 2.4G STA will be able to see the WLAN after trying for a second time if the first time of refreshing the WLAN list fails to achieve that result.

5.1.2 Configuring Band Select

I. Requirements

All Ruijie AP supports "Band Select" feature except for AP110-W、AP220-E v2.x、AP220-E(C) v3.0、AP220-E(M) v2.x、AP220-I 1.x、AP220-SI v1.x、AP220-SH v 2.x、AP220-SH (C)v3.0、AP220-SH(C) v2.99、AP220-E(C) v2.99、AP620-H(C) v2.x

II. Network Topology

None

III. Configuration Steps

1. Enabling Band Select

Method 1. Enabling Band Select in all WLAN

```
Ruijie>enable
Ruijie#configure terminal
Ruijie(config)#band-select enable
```

Method 2. Enabling Band Select in a specified WLAN

```
Ruijie>enable
Ruijie#configure terminal
Ruijie(config)#wlan-config 520
Ruijie(config-wlan)#band-select enable
```

Configuring Band Select on Fat AP

```
Ruijie(config)#dot11 wlan 520
Ruijie(dot11-wlan-config)#band-select enable
```

2. For additional optional parameters, see AC& AP configuration guide, you may download it at <http://www.ruijienetworks.com>

IV. Verification

1. Display Band Select status, execute commands "show wlan-config cb 520". 520 is the WLAN-ID

```
WS6008#show wlan-config cb 520
WLAN ID..... 520
SSID..... TAC-OVERSEA
Profile.....
MAC Mode..... Local
Tunnel Mode..... 802.3 Tunnel
Suppress SSID..... Disable
sta-limit..... 12
NAS ID.....
Band Select..... Enable
SSID Code..... utf-8
```

2. Display wireless clients status, execute commands "show ac-config client",

```
WS6008#show ac-config client
***** show sta status *****
AP : ap name/radio id
Status: Speed/Power Save/work Mode/roaming State, E = enable power save, D = disable power save

Total Sta Num : 1
STA MAC      IPV4 Address  AP              wlan Vlan Status  Asso Auth  Net Auth  up time
-----
ec26.cae1.1999 172.29.6.138  ap130/2        520 6      6.0M/D an OPEN      WEB      0:00:00:25
WS6008#
WS6008#
```

5.1.3 FAQ

5.1.3.1 How to check whether the band-select function is enabled

Run the **show band-select configuration** command to see whether 5G preferential access is enabled.

```
Ruijie#show band-select configuration

Band Select Configuration
Access denial..... 2
Probe Cycle Count..... 2
Scan Cycle Period Threshold (milliseconds)..... 200
Age Out Suppression (seconds)..... 20
Age Out Dual Band (seconds)..... 60
Acceptable Client RSSI (dBm)..... -80
```

5.1.3.2 What are the influences when band-select is configured for AP?

AP does not respond to request from 2.4G frequency band before identifying STA. Thus, single-band 2.4G STA cannot detect WLAN in two second.

After AP identifies STA, dual-band STA does not respond to request of 2.4G frequency band but STA can still detect WLAN passively. In other words, some dual-band STAs can detect WLAN of 2.4G frequency band.

After AP identifies STA, dual-band STA responds to only one of N (which can be configured) authentication requests of 2.4G frequency band. Generally, if a dual-band STA detects that WLAN has the BSSID at both the 2.4G frequency band and 5G frequency band, when re-authentication request at one frequency band is not responded, it will try another frequency band. However, some dual-band STAs may always send authentication request to the same frequency band. Assuming that a dual-band STA sends M authentication requests to 2.4G frequency band before trying 5G frequency band, when N is larger than M, the STA can connect to 5G frequency band; otherwise, the STA connects to 2.4G frequency band. Whichever frequency band is used, if the dual-band STA try the 2.4G frequency band first, there is always min (M,N) requests are neglected, resulting in prolonged STA connection time. The prolonged STA connection time depend on the STA driver. For example, if STA sends authentication requests at an interval of 00 ms and four authentication requests are neglected, the STA connection time is prolonged by 400 ms.

5.1.3.3 What is the AP action when Band Select (5G preferential access) is enabled?

Before STA is identified:

AP does not respond to request of 2.4G frequency band.

AP responds to request of 5G frequency band.

After STA is identified:

Single-band 2.4G STA responds to only one of multiple requests and can connect to the WLAN.

Single-band 5G STA responds to all requests and can connect to the WLAN.

Dual-band STA does not respond to request of 2.4G frequency band but responds to 5G frequency band. It can connect to WLAN of 5G frequency band. It responds to only one of multiple requests from 2.4G frequency band and can connect to the WLAN.

5.1.3.4 Default 5G Preferential Access Parameters

Parameter	Default Value
Band Select	Disabled
Acceptable lower limit of STA RSSI	-80 dBm
Count of denies request of associating dual-band STA with 2.4G frequency band	4
Count of restrained STA	2
Aging scanning period of STA information	500 ms
Aging time of dual-band STA information	60s
Aging time of restrained STA information	20s

5.1.3.5 How to adjust 5G Preferential Access Parameters

Ruijie(config)# band-select acceptable-rssi value //Indicates acceptable lower limit of STA RSSI.

Ruijie(config)# band-select probe-count value //Indicates count of restrained STA.

Ruijie(config)# band-select scan-cycle period //Indicates aging scanning period of STA information.

Ruijie(config)# band-select age-out dual-band value //Indicates aging time of dual-band STA information.

Ruijie(config)# band-select age-out suppression value //Indicates aging time of restrained STA information.

5.2 AC Virtualization (VAC)

5.2.1 Implementation Preparation

5.2.1.1 Outline

The following figure shows the VAC network topology. Spare ports on the core switch (or an extra switch) can be used to establish VSL links to ACs.

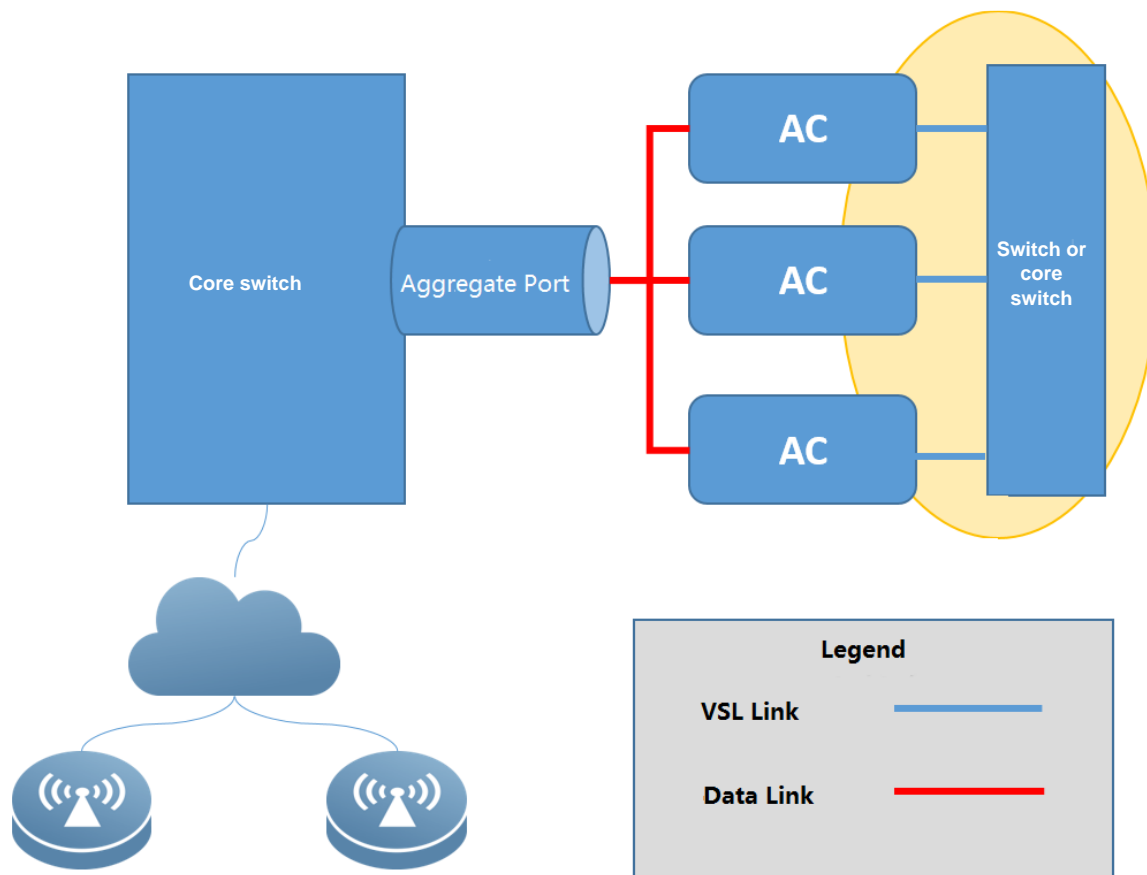

5.2.1.2 Prerequisites

- The device types of all member ACs must be the same. For example, multiple WS6108 devices can form a VAC and multiple N18K-WS devices can form a VAC. In contrast, WS6108 devices and WS6816 devices cannot form a VAC, and WS6108 devices and WS6008 devices cannot form a VAC.
 - If more than two box-type ACs form a VAC, spare ports on the uplink switch (core switch in the preceding figure) or an extra switch is required to establish VSL links to ACs. The number of ports is determined based on the number of VSL links planned for each AC. If the number of ports is sufficient, it is recommended that two VSL links be planned for each AC.
-
- ❗ If two box-type ACs form a VAC, direct connections between ACs can be used as VSL links. Multiple VSL links can be planned for each AC (including box-type and card-type ACs) and serve as backups for each other.
-
- The ports on the switch used to establish VSL links must support giant frame forwarding, and the layer-2 MTU is set to 9216.
 - The ports used to connect to data links on the switch must support port aggregation. In addition, the load-sharing of the aggregation port is based on the source IP address or source and destination IP addresses.
-
- ❗ Currently, most low-end, middle-range, and high-end switches support giant frame forwarding and load-sharing over the aggregation port.

- Service links of box-type ACs need to be connected to the same uplink switch (core switch in the preceding figure).
- Card-type ACs need to be configured in the same subrack or the VSU formed by different subracks.
- Check the functions required by the customer. For details about supported and unsupported functions in the current VAC version, see chapter 5.2.5 "Service Deployment."
- Check whether cross-WLAN roaming in centralized forwarding mode is required. This function is not supported currently. Communicate with the customer about this function in advance.

5.2.2 Fast Implementation

5.2.2.1 Preparations

Before implementation, make the following preparations:

1. Plan IP addresses of ACs. A VAC is regarded as an AC and only one CAPWAP control IP address is required.
2. Compared with a standalone AC, a VAC has VSL links. Plan the ports on the switch to connect VSL links and data links.
3. If the deployed environment is reconstructed, wireless configurations on multiple ACs, including WLAN, AP group, and AP configurations, need to be combined.
4. VAC configurations and standalone AC configurations cannot be multiplexed. It is recommended that after ACs be combined to form a VAC, perform configuration again. Upon mode switching, the VAC will store standalone AC configurations. It is recommended that the standalone AC configurations be manually backed up.

Note: If a wireless network is newly deployed or the live wireless network is reconstructed, it is recommended that the VAC be configured before cable connection or the shutdown operation on corresponding ports. In this case, loops occurring before VAC configuration can be prevented.

5.2.2.2 Configuration Implementation

This section describes how to deploy a VAC, excluding wireless service deployment. The deployment differences between box-type ACs and card-type ACs are described in corresponding steps.



VAC Configuration.txt

In the following configuration steps, ports 0/1 and 0/2 on the ACs are used as the service ports and ports 0/4 and 0/5 on the ACs are used as VSL ports.

5. Check the AC boot version.

M18000-WS-ED: The boot version needs to be upgraded to 1.2.10 or later.

- ❗ The boot version needs to be upgraded because the three rear ports on the M18000-WS-ED card are in the UP state during startup. As a result, when the M18000-WS-ED card connects to the uplink switch, traffic will be forwarded to this

AC at an earlier time, resulting in packet loss. By default, the two front ports on the M18000-WS-ED card are in the DOWN state. If the two front ports are used as the service ports, the boot version does not need to be upgraded.

6. Upgrade the AC version to B9.

Run the **upgrade download tftp** command to upgrade the AC versions to a version that supports VAC (that is, B9 or later).

7. Perform VAC configuration on the ACs.

Specify the ID of the device to which each AC belongs. The device ID starts from 1. Specify VSL ports. It is recommended that two ports on each AC be configured as VSL ports.

VAC configurations and standalone AC configurations are not multiplexed. Before VAC deployment, export and save standalone AC configurations. After the VAC is deployed, import the standalone AC configurations. (Before the import, modify port-related configurations. For example, the original te0/1 port is a service port, to cut configurations of the te0/1 port over to the aggregation port, add the te1/0/1 port to the aggregation port first. If the wireless-related configurations on each AC are different, the wireless-related configurations need to be integrated before being imported.)

Configurations on the first AC:

```
Ruijie>enable AC(config)#virtual-ac domain 100 # The domain ID is a digit. The same domain ID must be configured for each AC.
AC(config-vac-domain)#device 1 # Specify the device ID of the AC.
AC(config-vac-domain)#device 1 priority 200 # A higher priority indicates a higher probability of being selected as the active AC.
AC(config-vac-domain)#device 1 description switch1-slot3 # Define description to facilitate AC location query.
AC(config-vac-domain)#exit
AC(config)# vac-port
AC(config-vac-port)#port-member interface gigabitEthernet 0/4 # Specify VSL ports. On the WS card, specify TE ports as VSL ports.
AC(config-vac-port)#port-member interface gigabitEthernet 0/5
```

Configurations on the second AC:

```
AC(config)#virtual-ac domain 100
AC(config-vac-domain)#device 2 # Specify the device ID of the AC.
AC(config-vac-domain)#device 2 priority 100
AC(config-vac-domain)#device 2 description switch1-slot4
AC(config-vac-domain)#exit
AC(config)# vac-port
AC(config-vac-port)#port-member interface gigabitEthernet 0/4
AC(config-vac-port)#port-member interface gigabitEthernet 0/5
```

Configurations on other ACs are similar to the preceding ones. Specify the device ID and VSL ports.

-  The domain ID is used to identify a VAC, which ranges from 1 to 255. ACs within the same VAC must be specified with the same domain ID. The device ID is used to identify an AC within a VAC. The device IDs of ACs within one VAC are

numbered by 1, 2, 3, 4, and 5. The AC priority is used for active AC selection during VAC startup. The AC with the highest priority is selected as the active AC. In normal cases, for ease of identifying the active and standby ACs, device 1 is configured with the highest priority and device 2 is configured with the second highest priority.

8. Configure the aggregation port on the uplink switch.

Service ports on ACs used to connect to the uplink switch need to be added to the aggregation port, and the load-sharing of the aggregation port is based on the source and destination IP addresses.

The uplink switch may not be provided by Ruijie, and therefore, needs to be configured based on the actual commands.

```
ruijie (config)#interface aggregateport 1 # The aggregation port ID is configured based on the actual switch condition.
ruijie (config-if-AggregatePort 1) # switchport mode trunk # The aggregation port is configured based on the actual
network deployment requirements.
ruijie (config-if-AggregatePort 1) #exit
ruijie (config)#interface gigabitEthernet 0/1
ruijie(config-if- GigabitEthernet 0/1)#port-group 1 # Add service ports to the aggregation port.
ruijie (config-if- GigabitEthernet 0/1)#interface gigabitEthernet 0/2
ruijie(config-if- GigabitEthernet 0/2)#port-group 1
ruijie(config-if- GigabitEthernet 0/2)#exit # Add all service ports on the switch to the aggregation port using the same
method.
ruijie (config)#aggregateport load-balance src-dst-ip # (Mandatory) Configure the load-sharing policy.
```

❗ If a port on the M18000-WS-ED card is not used as the service port or VSL port, it is recommended that unused internal ports on the 18K are shut down.

9. Set the MTU value of the VSL port on the uplink switch to 9216 and configure an independent VLAN for the VSL ports. (The MTU does not need to be configured on ACs.)

```
ruijie(config-if-xxx)#mtu 9216
ruijie(config-if-xxx)#switchport access vlan 2024 # Obtain an unused VLAN based on actual conditions.
```

❗ The VSL ports of all member ACs must belong to the same layer-2 LAN and be configured with the same VLAN. It is recommended that non-VSL ports be removed from the VLAN, that is, an independent VLAN be planned only for VSL links.

10. Switch ACs to the VAC mode.

For box-type ACs, connect VSL ports on the ACs to VSL ports on the uplink switch. Then, switch the ACs to the VAC mode.

```
AC#write # Before restarting the VAC, save the VAC configurations.
AC#device convert mode virtual
Convert mode will backup and delete config file, and reload the switch. Are you sure to continue[yes/no]:yes
Do you want to recover config file from backup file in virtual mode (press 'ctrl + c' to cancel) [yes/no]:yes
```

- ❗ Configurations in independent mode and VAC mode cannot be multiplexed. After ACs are switched to the VAC mode, there is no AC configuration. The standalone AC configurations are backed up. The back files are **standalone.text** and **ap-standalone.text**. Wireless configurations of the VAC needs to be configured after the ACs are switched to the VAC mode.

11. Configure service ports on the active AC.

After the ACs are started, run the **show virtual-ac** command to query member ACs of the VAC. After the ACs form a VAC normally, service ports on the active AC can be configured and added to the aggregation port.

```
AC(config)#interface aggregateport 1
AC(config-if-AggregatePort 1)#switchport mode trunk # Configure the aggregation port based on actual conditions.
AC(config-if-AggregatePort 1)#exit
AC(config)#interface gigabitEthernet 1/0/1 # On the M18K-WS-ED card, the service ports are TE ports.
AC(config-if-GigabitEthernet 1/0/1)#port-group 1
AC(config-if-GigabitEthernet 1/0/1)# interface gigabitEthernet 1/0/2
AC(config-if-GigabitEthernet 1/0/2)# port-group 1 # 同样的方法将其他口加入聚合口# Add other ports to the aggregation port
using the same method.
```

After service ports are configured, connect service ports on box-type ACs to service ports on the uplink switch.

In this case, the VAC environment is set up.

5.2.2.3 Acceptance

```
show virtual-ac
```

Query the device ID, priority, and role information about each AC. If an AC is not displayed, the AC is not added to the VAC.

Device_id	Domain_id	Priority	Position	Status	Role	Description
1 (1)	90 (90)	100 (100)	LOCAL	OK	ACTIVE	switch1-slot3
2 (2)	90 (90)	90 (90)	REMOTE	OK	STANDBY	switch1-slot4
4 (4)	90 (90)	50 (50)	REMOTE	OK	CANDIDATE	switch1-slot5

```
show virtual-ac topology
```

Query the role and MAC address of each AC. (The MAC address is not the actually used MAC address.)

```
Switch[1]: ACTIVE, MAC: 5869.6c1c.43f7, Description:
Switch[2]: STANDBY, MAC: 5869.6c75.0002, Description:
Switch[4]: CANDIDATE, MAC: 003a.b64e.2500, Description:
```

```
show virtual resource
```

Query the CPU usage, memory usage, and flash usage of member ACs.

Device_id	CPU(5s)	CPU(1m)	CPU(5m)	Memory	Flash
1	2.80%	4.00%	3.10%	48%	87% (34963KB free)
2	2.40%	4.60%	3.70%	48%	95% (12111KB free)
4	10.40%	7.40%	6.00%	52%	81% (52776KB free)

show interface status

Query the port status. If the ports are normal, the VSL and service ports are in the UP state.

Interface	Status	Vlan	Duplex	Speed	Type
GigabitEthernet 1/0/5	up		Full	100M	copper
GigabitEthernet 1/0/8	up	201	Full	100M	copper
GigabitEthernet 2/0/5	up		Full	100M	copper
GigabitEthernet 2/0/8	up	201	Full	100M	copper
GigabitEthernet 4/0/5	up		Full	100M	copper
GigabitEthernet 4/0/8	up	201	Full	100M	copper
AggregatePort 2	up	201	Full	100M	copper

show virtual-ac balance-info

After APs go online, use this command to query APs and STA association on ACs.

Dev ID	AP Num	AP License	STA Num
1	1	1.0	0
2	3	6.0	1
4	0	0.0	0

show interface counters rate

After APs go online, use this command to query the traffic over each port. In normal cases, each service port has uplink and downlink traffic.

5.2.3 Fast Implementation in VSU Scenarios

5.2.3.1 Preparations

This section describes how to implement the VAC when multiple subracks form the VSU and WS cards in different subracks form a VAC. The following figure is used as an example. In this figure, there are two subracks and each subrack has two WS cards. The two subracks form a VSU, and the four WS cards form a VAC.

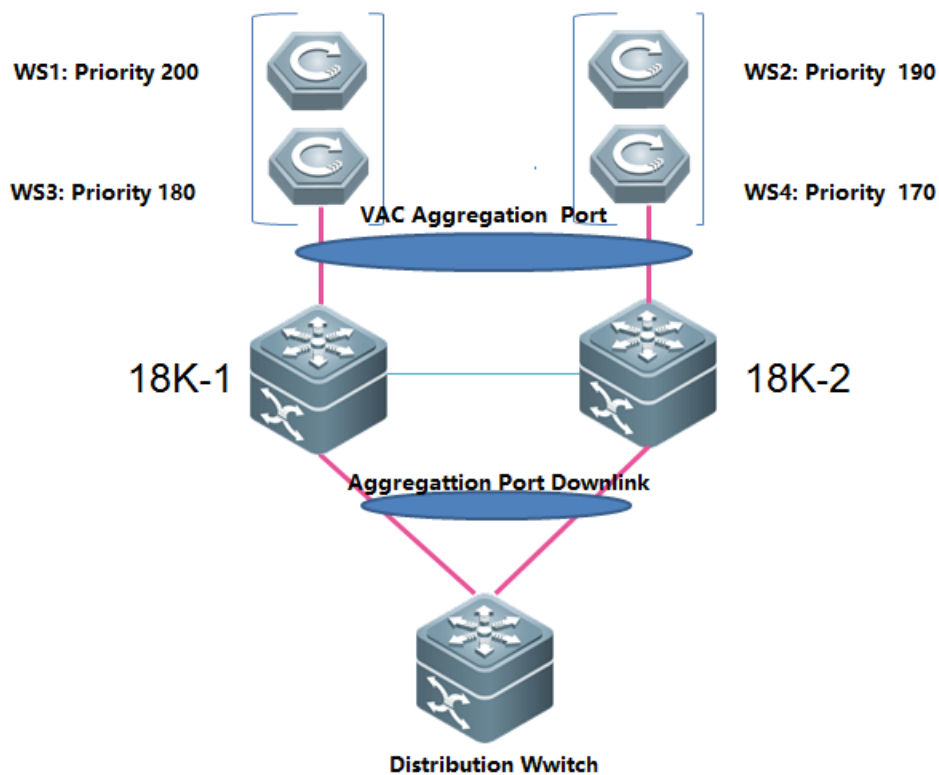

Plan the AC priorities. The ACs with the highest priority and third highest priority connect to the 18K-1 and ACs with the second highest priority and lowest priority connect to the 18K-2. This prevents the active and standby ACs connect to the same 18K.

The two internal ports in the front on the WS cards are used as service ports, and port 0/5 is used as the VSL port.

5.2.3.2 Configuration Implementation

This section describes how to deploy a VAC under the VSU, excluding wireless service deployment.

In the following configuration steps, ports 0/1 and 0/2 on the ACs are used as the service ports and port 0/5 on the ACs is used as the VSL port.

12. Check the AC boot version.

If ports 0/3, 0/4, and 0/5 are used as the service ports and the traffic interruption time during hot AC addition or removal is sensitive, perform this step. Otherwise, skip this step.

M18000-WS-ED: The boot version needs to be upgraded to 1.2.10 or later.

- ! The boot version needs to be upgraded because the three rear ports on the M18000-WS-ED card are in the UP state during startup. As a result, when the M18000-WS-ED card connects to the uplink switch, traffic will be forwarded to this AC at an earlier time, resulting in packet loss. By default, the two front ports on the M18000-WS-ED card are in the DOWN state. Therefore, it is recommended that the two front ports be used as service ports. Normal use is not affected if the boot version is not upgraded. However, packet loss of several seconds occurs during hot AC addition or removal.

13. Upgrade the AC version to B9.

Run the **upgrade download tftp** command to upgrade the AC versions to a version that supports VAC.

14. Perform VAC configuration on WS cards.

Specify the ID of the device to which each AC belongs. The device ID starts from 1. Specify VSL ports.

VAC configurations and standalone AC configurations are not multiplexed. Before VAC deployment, export and save standalone AC configurations. After the VAC is deployed, import the standalone AC configurations. (Before the import, modify port-related configurations. For example, the original te0/1 port is a service port, to cut configurations of the te0/1 port over to the aggregation port, add the te1/0/1 port to the aggregation port first. If the wireless-related configurations on each AC are different, the wireless-related configurations need to be integrated before being imported.)

Configurations on WS1:

```
AC(config)#virtual-ac domain 100 # The domain ID is a digit. The same domain ID must be configured for each AC.
AC(config-vac-domain)#device 1 # Specify the device ID of the AC.
AC(config-vac-domain)#device 1 priority 200 # A higher priority indicates a higher probability of being selected as the active AC.
AC(config-vac-domain)#device 1 description switch1-slot3
AC(config-vac-domain)#exit
AC(config)# vac-port
AC(config-vac-port)#port-member interface te 0/5
```

Configurations on the second AC:

```
AC(config)#virtual-ac domain 100
AC(config-vac-domain)#device 2 # Specify the device ID of the AC.
AC(config-vac-domain)#device 2 priority 190
AC(config-vac-domain)#device 2 description switch2-slot5
AC(config-vac-domain)#exit
AC(config)# vac-port
AC(config-vac-port)#port-member interface te 0/5
```

Configurations on other ACs are similar to the preceding ones. Specify the device ID and VSL ports.

-  The domain ID is used to identify a VAC, which ranges from 1 to 255. ACs within the same VAC must be specified with the same domain ID. The device ID is used to identify an AC within a VAC. The device IDs of ACs within one VAC are numbered by 1, 2, 3, 4, and 5. The AC priority is used for active AC selection during VAC startup. The AC with the highest priority is selected as the active AC. In normal cases, for ease of identifying the active and standby ACs, device 1 is configured with the highest priority and device 2 is configured with the second highest priority.

15. Configure the aggregation port on the 18K.

The 18K and WS card are connected through an internal port. Corresponding service ports on the 18K need to be added to the aggregation port, and the load-sharing of the aggregation port is based on the source and destination IP addresses. It is

recommended to use the enhanced load-sharing policy, that is, the **aggregateport load-balance enhanced** command below.

```
18K(config)# load-balance-profile vac-load-balance-profile
18K(config-load-balance-profile)# ipv4 field src-ip dst-ip
18K (config)#interface aggregateport 1 # The aggregation port ID is configured based on the actual switch condition.
18K(config-if-AggregatePort 1)# aggregateport load-balance enhanced profile vac-load-balance-profile # Configure the load-sharing policy.
18K (config-if-AggregatePort 1) # switchport mode trunk # The aggregation port is configured based on the actual network deployment requirements.
18K (config-if-AggregatePort 1) #exit
18K (config)# interface TenGigabitEthernet 1/9/3
18K(config-if-TenGigabitEthernet 1/9/3)#port-group 1 # Add service ports to the aggregation port.
18K (config-if-TenGigabitEthernet 1/9/3)# interface TenGigabitEthernet 1/9/4
18K(config-if-TenGigabitEthernet 1/9/4)#port-group 1
18K (config-if-TenGigabitEthernet 1/9/4)# interface TenGigabitEthernet 1/9/5
18K(config-if-TenGigabitEthernet 1/9/5)#shutdown # Shut down unused internal ports.
18K (config-if-TenGigabitEthernet 1/9/5)# interface TenGigabitEthernet 1/9/6
18K(config-if-TenGigabitEthernet 1/9/6)#shutdown # Shut down unused internal ports.
18K(config-if-TenGigabitEthernet 1/9/6)#exit # Add service ports on the 18K for connecting other ACs to the aggregation port using the same method.
```

! If a port on the M18000-WS-ED card is not used as the service port or VSL port, it is recommended that unused internal ports on the 18K are shut down.

16. Set the MTU value of the VSL ports on the 18K to 9216 and configure an independent VLAN for the VSL ports.

```
18K (config)# interface TenGigabitEthernet 1/9/7
18K(config-if-TenGigabitEthernet 1/9/7)#mtu 9216
18K(config-if-TenGigabitEthernet 1/9/7)#switchport access vlan 2024 # Obtain an unused VLAN based on actual conditions, and ensure that the obtained VLAN is different from the VLAN used by VSL ports on the 18K,.
```

! The VSL ports of all member ACs must belong to the same layer-2 LAN and be configured with the same VLAN. It is recommended that non-VSL ports be removed from the VLAN, that is, an independent VLAN be planned only for VSL links.

17. Switch ACs to the VAC mode.

```
AC#write # Before restarting the VAC, save the VAC configurations.
AC#device convert mode virtual
Convert mode will backup and delete config file, and reload the switch. Are you sure to continue[yes/no]:yes
Do you want to recover config file from backup file in virtual mode (press 'ctrl + c' to cancel) [yes/no]:yes
```

- ❗ Configurations in independent mode and VAC mode cannot be multiplexed. After ACs are switched to the VAC mode, there is no AC configuration. The standalone AC configurations are backed up. The back files are **standalone.text** and **ap-standalone.text**. Wireless configurations of the VAC needs to be configured after the ACs are switched to the VAC mode.

18. Configure service ports on the active AC.

After the ACs are started, run the **show virtual-ac** command to query member ACs of the VAC. After the ACs form a VAC normally, service ports on the active AC can be configured and added to the aggregation port.

```
AC(config)#interface aggregateport 1
AC(config-if-AggregatePort 1)#switchport mode trunk # Configure the aggregation port based on actual conditions.
AC(config-if-AggregatePort 1)#exit
AC(config)#interface TenGigabitEthernet 1/0/1
AC(config-if- TenGigabitEthernet 1/0/1)#port-group 1
AC(config-if- TenGigabitEthernet 1/0/1)# interface TenGigabitEthernet 1/0/2
AC(config-if- TenGigabitEthernet 1/0/2)# port-group 1 # Add other ports to the aggregation port using the same method.
```

- ❗ For M8600E-WS-ED model, need to configure dynamic aggregation port(LACP) to prevent the delay of aggregation port member failure in static mode.

```
AC
AC (config-if-GigabitEthernet 1/0/1)# port-group 1 mode active
AC (config-if-GigabitEthernet 1/0/1)# lacp short-timeout
AC (config-if-GigabitEthernet 2/0/1)# port-group 1 mode active
AC (config-if-GigabitEthernet 2/0/1)# lacp short-timeout

SWITCH
WS (config-if-GigabitEthernet 0/10)# port-group 1 mode active
WS (config-if-GigabitEthernet 0/10)# lacp short-timeout
WS (config-if-GigabitEthernet 0/10)# exit
WS (config)# interface gigabitEthernet 0/11
WS (config-if-GigabitEthernet 0/11)# port-group 1 mode active
WS (config-if-GigabitEthernet 0/11)# lacp short-timeout
```

19. Enable the standby AC preemption function on the active AC.

```
Ruijie>enable AC(config)#virtual-ac domain 100
AC(config-vac-domain)# slave preemptive enable # Enable the standby AC preemption function.
```

In this case, the VAC environment is set up. Read chapters 5.2.5 "Service Deployment" and **错误!未找到引用源。** "Key Configuration Check" to learn about wireless service deployment.

5.2.3.3 Acceptance

Same as that in section 5.2.2.3 "Acceptance."

5.2.4 Capacity Expansion Implementation

5.2.4.1 Preparations

Check the maximum number of member ACs supported in a VAC.

AC Model	Number of Member ACs
WS5708/M8600-WS/M12000-WS	VAC is not supported.
M18000-WS-ED/M8600E-WS-ED	8
WS6008	4
WS6108	4
WS6812	8
WS6816	8

Upgrade the version of new ACs to the same version as the current VAC.

5.2.4.2 Configuration Implementation

If WS cards are used, the switch in the following steps is the 18K. The following describes how to add an AC to a VAC.

1. Add service ports on the switch to the aggregation port.

```
ruijie (config)#interface gigabitEthernet 0/1 # Add service ports to the aggregation port based on actual conditions.
ruijie(config-if- GigabitEthernet 0/1)#port-group 1 # Configure the aggregation port ID based on actual conditions.
ruijie (config-if- GigabitEthernet 0/1)#interface gigabitEthernet 0/2
ruijie(config-if- GigabitEthernet 0/2)#port-group 1
```

2. Configure VSL ports on the switch to connect to ACs.

```
ruijie(config-if-xxx)#mtu 9216
ruijie(config-if-xxx)#switchport access vlan 2024 # Obtain an unused VLAN based on actual conditions.
```

3. Perform VAC configuration on ACs.

```
AC(config)#virtual-ac domain 100 # The domain ID must be the same as that of the current VAC.
AC(config-vac-domain)#device 3 # The device ID is an ID not used by the current VAC.
AC(config-vac-domain)#device 3 priority 80
AC(config-vac-domain)#exit
AC(config)# vac-port
AC(config-vac-port)#port-member interface gigabitEthernet 0/4 # Specify VSL ports. On the WS card, specify TE ports as
VSL ports.
AC(config-vac-port)#port-member interface gigabitEthernet 0/5
```

4. Switch the ACs to the VAC mode.

For box-type ACs, connect VSL ports on the ACs to VSL ports on the uplink switch. Then, switch the ACs to the VAC mode.

```
AC#write # Before restarting the VAC, save the VAC configurations.
```

```
AC#device convert mode virtual
```

```
Convert mode will backup and delete config file, and reload the switch. Are you sure to continue[yes/no]:yes
```

```
Do you want to recover config file from backup file in virtual mode (press 'ctrl + c' to cancel) [yes/no]:yes
```

In this case, the new AC is automatically added to the VAC after being restarted.

5.2.4.3 Acceptance

Run the **show virtual-ac** command on the active AC to check whether the new AC is added to the VAC. In normal case, when the new AC is started up, the active AC can view the new AC, and the corresponding device ID can be queried from the **show virtual-ac** command output.

```
show virtual-ac
```

Device_id	Domain_id	Priority	Position	Status	Role	Description
1(1)	90(90)	100(100)	LOCAL	OK	ACTIVE	
2(2)	90(90)	90(90)	REMOTE	OK	STANDBY	
4(4)	90(90)	50(50)	REMOTE	OK	CANDIDATE	

```
show interface status
```

Query the port status. In normal cases, the service port is DOWN and the VSL port is UP on the new AC. After all table entries are synchronized to the new AC, the service port is changed to the UP state and starts to work.

Interface	Status	Vlan	Duplex	Speed	Type
GigabitEthernet 1/0/1	up	1	Full	100M	copper
GigabitEthernet 1/0/2	up	1	Full	100M	copper
GigabitEthernet 1/0/3	down	1	Unknown	Unknown	copper
GigabitEthernet 1/0/4	down	1	Unknown	Unknown	copper
GigabitEthernet 1/0/5	up		Full	100M	copper
GigabitEthernet 1/0/6	down	1	Unknown	Unknown	copper
GigabitEthernet 1/0/7	down	1	Unknown	Unknown	copper
GigabitEthernet 1/0/8	down	1	Unknown	Unknown	copper
GigabitEthernet 2/0/1	up	1	Full	100M	copper
GigabitEthernet 2/0/2	up	1	Full	100M	copper
GigabitEthernet 2/0/3	down	1	Unknown	Unknown	copper
GigabitEthernet 2/0/4	down	1	Unknown	Unknown	copper
GigabitEthernet 2/0/5	up		Full	100M	copper
GigabitEthernet 2/0/6	down	1	Unknown	Unknown	copper
GigabitEthernet 2/0/7	down	1	Unknown	Unknown	copper
GigabitEthernet 2/0/8	down	1	Unknown	Unknown	copper

GigabitEthernet 4/0/1	up	1	Full	100M	copper
GigabitEthernet 4/0/2	up	1	Full	100M	copper
GigabitEthernet 4/0/3	down	1	Unknown	Unknown	copper
GigabitEthernet 4/0/4	down	1	Unknown	Unknown	copper
GigabitEthernet 4/0/5	up		Full	100M	copper
GigabitEthernet 4/0/6	down	1	Unknown	Unknown	copper
GigabitEthernet 4/0/7	down	1	Unknown	Unknown	copper
GigabitEthernet 4/0/8	down	1	Unknown	Unknown	copper

After the new AC starts and table entries are synchronized, the service port is changed to the UP state and a large number of APs are migrated to the AC, which can be confirmed through syslogs.

5.2.5 Service Deployment

5.2.5.1 Services Not Supporting VAC

Currently, AC virtualization does not support the following functions:

IPv6

NAT (NAT enabled on ACs)

Wi-Fi connection via WeChat

Web first-generation authentication and authentication for MCP/WMC interworking

GSN

Hot backup between VACs

Roaming between 2 or more VAC instances

Zone control function

Intra-frequency networking

RPCAP(Remote Packet Capture system)

RF ping

RRM

RIPT

Proactive AP load-sharing on ACs is not supported, and AP load-sharing depends on load-sharing of the aggregation port on the uplink switch. When the AC and AP are deployed across networks of different ISPs (through NAT), the source IP addresses of APs may be the same, and APs with the same source IP address will be connected to the same member AC, resulting in a poor AP load-sharing effect.

Port mirroring is not supported. If port mirroring is enabled, packets are transmitted over the VSL ports, which may result in VAC splitting.

5.2.5.2 Configuration Operations

AC virtualization can be configured only on the active AC. If the AC connected through the serial port is not the active AC, run the **session master** command to connect to the active AC for configuration. You can run the **show run** command on ACs to query the AC configurations.

On a non-active AC, the IP address configurations of ports cannot be queried by running the **show running-config** command.

Note AP offline configurations. For example, if the **11acsupport enable radio 2** command is configured for an AP in offline mode and the AP goes online through the standby AC, the AP configuration is changed to **no 11acsupport enable radio 2** on the standby AC as the AP does not support 802.11ac. On the active AC, the AP configuration is still **11acsupport enable radio 2**. A large number of other similar commands are changed when an AP goes online. Currently, the configuration change is presented only on the AC associated with the AP. This situation does not affect normal AP usage.

5.2.5.3 AP Management Operations

When a satellite AP is associated with a VAC, the satellite AP information possibly cannot be queried from the VAC by running the **show ap-sr summary** command.

When the **show ap-config** command is run on the VAC, only the license information about the local AC can be queried. The license information of the VAC cannot be queried.

 The preceding two points are known issues in the current version and will be rectified in the next version.

5.2.5.4 STA Management Operations

Currently, the VAC does not support the zone control function. The zone control function does not take effect to the whole VAC.

Currently, the VAC does not support cross-WLAN roaming in centralized forwarding mode. Cross-WLAN indicates that two WLANs are configured, and the two WLANs have the same SSID and encrypted authentication mode. Different APs map to different VLANs, and STAs roam between the two WLANs. Communicate with the customer in advance about this situation before network deployment or reconstruction.

5.2.5.5 AC/AP Upgrade Operations

5.2.5.5.1 AC Upgrade

When the software version of a VAC is upgraded, all member ACs within the VAC will be upgraded at the same time. If the flash memory of one member AC is insufficient or the AC cannot be upgraded due to other causes, the VAC upgrade fails. When a new member AC is added and the software version of the member AC is different from the software version of other member ACs in the VAC, the member AC is not automatically upgraded and cannot be added to the VAC. The new member AC can be added to the VAC only after the administrator upgrades the software version of the new member AC independently.

You can run the **show virtual-ac resource** command on ACs to check whether the flash memory is sufficient. If a **.bin.up.tmp** file (upgrade file for the previous AC version upgrade) exists in the flash memory, the file can be deleted.

```
Device_id CPU(5s) CPU(1m) CPU(5m) Memory Flash
-----
1          2.50%  3.60%  2.80%  48%   87% (34922KB free)
2          3.80%  4.80%  3.50%  48%   95% (12140KB free)
3          4.90%  6.80%  5.40%  52%   81% (50823KB free)
```

5.2.5.5.1.2 AP Upgrade

The AP upgrade file needs to be synchronized to member ACs. If the flash memory of a member AC is insufficient, the upgrade file synchronization fails. In this case, the AP associated with that member AC will not be automatically upgraded.

You can run the **show ac-config active-file status** command to check whether file transfer fails. If the file transfer fails, run the **dir dev2_flash** and **delete dev2_flash:xxx** commands in privileged EXEC mode to delete unused files on the device and run the **active-bin-file** command again after sufficient space is provided.

```
show ac-config active-file status
```

Check whether upgrade file synchronization to an AC is abnormal.

File Name	Software number	Device File Tx	Description
ap110.bin	M02211607122016	1 100 %	Success
ap110.bin	M02211607122016	3 100 %	Success
am5528-b9-0705.bin	M06162807052016	2 0 %	Flash space not enough

```
AC# dir dev2_flash:
```

Query the flash memory information of an AC with a specified device ID.

```
-rwxrwxrwx 1 anonymous ftp      130973 Jul 25 17:16 syslog_3.txt
drwxrwxrwx 2 anonymous ftp        160 Dec 04 2015 dev
drwxrwxrwx 2 anonymous ftp        160 Dec 04 2015 rep
drwxrwxrwx 3 anonymous ftp        224 Dec 04 2015 var
-rw-r--r-- 1 anonymous ftp      25017 Aug 23 10:21 virtual_switch.text
-rwxrwxrwx 1 anonymous ftp    15254656 Jun 07 10:54 ap320-rgos10.bin
-rwxrwxrwx 1 anonymous ftp      1329 Jun 06 19:56 getnext_mib_register.text
-rwxrwxrwx 1 anonymous ftp      126 Aug 23 16:24 config_vac.dat
-rwxrwxrwx 1 anonymous ftp    23643197 May 19 17:39 ap320-b9.bin
-rwxr-xr-x 1 anonymous ftp    83091668 Aug 23 14:48 ws5708-b9p2.bin.up.tmp
-rwxrwxrwx 1 anonymous ftp      130989 Jul 25 17:16 syslog_10.txt
-rwxrwxrwx 1 anonymous ftp      131009 Jul 25 17:16 syslog_11.txt
-rwxrwxrwx 1 anonymous ftp       887 Dec 04 2015 httpd_key.pem
```

```

-rwxrwxrwx  1 anonymous ftp      2811 Aug 15 17:44 standalone.text
-rwxrwxrwx  1 anonymous ftp      4997 Mar 22 18:02 card_ws5708_10.xml
-rwxrwxrwx  1 anonymous ftp     130968 Jul 25 17:16 syslog_1.txt
-rwxrwxrwx  1 anonymous ftp     130915 Jul 25 17:16 syslog_2.txt
66 files, 11 directories
281,903,104 bytes data total (68,780,032 bytes free)
536,870,912 bytes flash total (68,780,032 bytes free)

```

For example, the **ap320-rgos10.bin** file is useless. Delete the file and activate the upgrade file again.

```

AC# delete dev2_flash:ap320-rgos10.bin
AC#configure
AC(config)#ac-controller
AC(config-ac)#active-bin-file am5528-b9-0705.bin

```

! Use the **ap-image auto-upgrade** command for AP upgrades. After this command is run, an upgrade file is automatically provided for the AP for an upgrade based on the AP model. The **ap-serial** command is executed after the **active-bin-file** command. If the **no active-bin-file** command is executed when the upgrade file is synchronized to the standby AC, the upgrade file may be activated on the active AC but not activated on the standby AC. In this case, run the **show ac-config active-file status** command to query the upgrade file activation status on ACs. If inconsistency occurs, activate the upgrade file on the active AC again.

! If an AC sends the upgrade file to an AP, but the **no active-bin-file** command is configured, the upgrade file delivery will be stopped. APs that do not receive the upgrade file completely will be restarted after a period of time. After the APs are restarted, the version before the upgrade is used.

5.2.5.6 SNMP Management Operations

In AC virtualization, AC information needs to be collected from all member ACs when SNMP is used and the return speed may be slow. In this case, the SNMP cache function is added to cache SNMP data on member ACs to the active AC periodically to improve the table reading efficiency.

Note that the host updates the cache every 5 minutes by default after the SNMP cache function is configured. Therefore, when the server delivers the SNMP-GET operation, the data obtained may be generated in the previous 5 minutes. The update period can be adjusted based on the frequency of performing the GET operation by the EMS software.

```

snmp-server cache update-timer  # Configure the cache update interval. A short interval will result in high
snmp-server cache enable # Enable the SNMP cache function.
snmp-server cache oid 1.3.6.1.2.1.145.1.2.2.1

```



```
snmp-server cache oid 1.3.6.1.2.1.145.1.2.3.1
snmp-server cache oid 1.3.6.1.2.1.145.1.2.6.1
snmp-server cache oid 1.3.6.1.2.1.145.1.2.7.1
snmp-server cache oid 1.3.6.1.4.1.4881.1.1.10.2.1.1.39.1
snmp-server cache oid 1.3.6.1.4.1.4881.1.1.10.2.1.1.48.1
snmp-server cache oid 1.3.6.1.4.1.4881.1.1.10.2.1.1.49.1
snmp-server cache oid 1.3.6.1.4.1.4881.1.1.10.2.10.1.12.1
snmp-server cache oid 1.3.6.1.4.1.4881.1.1.10.2.10.1.13.1
snmp-server cache oid 1.3.6.1.4.1.4881.1.1.10.2.19.1.1.10.1
snmp-server cache oid 1.3.6.1.4.1.4881.1.1.10.2.19.1.1.11.1
snmp-server cache oid 1.3.6.1.4.1.4881.1.1.10.2.35.1.3.1
snmp-server cache oid 1.3.6.1.4.1.4881.1.1.10.2.36.1.3.1
snmp-server cache oid 1.3.6.1.4.1.4881.1.1.10.2.40.1.1.1
snmp-server cache oid 1.3.6.1.4.1.4881.1.1.10.2.40.1.5.1
snmp-server cache oid 1.3.6.1.4.1.4881.1.1.10.2.56.2.1.1.1
snmp-server cache oid 1.3.6.1.4.1.4881.1.1.10.2.56.2.1.2.1
snmp-server cache oid 1.3.6.1.4.1.4881.1.1.10.2.56.2.1.3.1
snmp-server cache oid 1.3.6.1.4.1.4881.1.1.10.2.56.2.1.6.1
snmp-server cache oid 1.3.6.1.4.1.4881.1.1.10.2.56.2.1.7.1
snmp-server cache oid 1.3.6.1.4.1.4881.1.1.10.2.56.5.1.1.1
snmp-server cache oid 1.3.6.1.4.1.4881.1.1.10.2.64.1.1.38.1
snmp-server cache oid 1.3.6.1.4.1.4881.1.1.10.2.64.1.1.39.1
snmp-server cache oid 1.3.6.1.4.1.4881.1.1.10.2.73.1.3.1.1.1
snmp-server cache oid 1.3.6.1.4.1.4881.1.1.10.2.81.1.3.1.1
snmp-server cache oid 1.3.6.1.4.1.4881.1.1.10.2.81.10.2.1.1
snmp-server cache oid 1.3.6.1.4.1.4881.1.1.10.2.81.10.4.1.1
snmp-server cache oid 1.3.6.1.4.1.4881.1.1.10.2.81.10.5.1.1
snmp-server cache oid 1.3.6.1.4.1.4881.1.1.10.2.81.10.5.2.1
snmp-server cache oid 1.3.6.1.4.1.4881.1.1.10.2.81.10.7.1.1
snmp-server cache oid 1.3.6.1.4.1.4881.1.1.10.2.81.14.2.1
snmp-server cache oid 1.3.6.1.4.1.4881.1.1.10.2.81.15.1.1
snmp-server cache oid 1.3.6.1.4.1.4881.1.1.10.2.81.16.1.1
snmp-server cache oid 1.3.6.1.4.1.4881.1.1.10.2.81.16.2.1
snmp-server cache oid 1.3.6.1.4.1.4881.1.1.10.2.81.2.1.1.1
snmp-server cache oid 1.3.6.1.4.1.4881.1.1.10.2.81.2.3.1.1
snmp-server cache oid 1.3.6.1.4.1.4881.1.1.10.2.81.3.1.1
snmp-server cache oid 1.3.6.1.4.1.4881.1.1.10.2.81.6.1.1
```

! The cache update period can be configured based on the software query period of the EMS server (SNC, RILL, or the like).

5.2.5.7 SNC Configuration Operations

When the SNC is used to interwork with the VAC, it is recommended that **Timeout (ms)** on the **Edit SNMP Template** page be changed to a value ranging from 10000 ms to 15000 ms and **Retry Count** be set to 3. If reading or configuration failure occurs on a page, **Timeout (ms)** and **Retry Count** can be set to larger values.

When the SNC is used to manage the VAC, VSL links between ACs will not be displayed on the device details page.

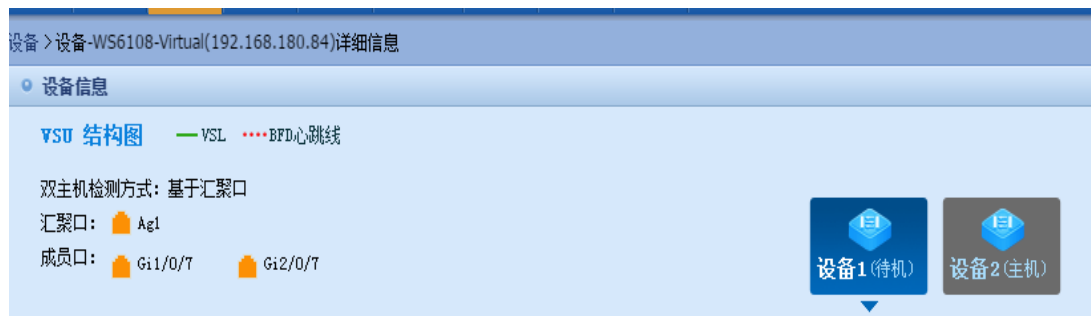

5.2.5.8 Dual-Active Detection

When box-type ACs form a VAC, it is recommended that the dual-active detection (DAD) function be enabled. If two box-type ACs form a VAC, it is recommended that BFD be used. The direct-connected links are used for detection. If more than two ACs are used, it is recommended that the aggregation port be used for detection. To use aggregation port detection, the switch must support DAD forwarding.

For example, use ports 0/3 on two ACs for direct connection and configure the BFD. The configuration steps are as follows:

```
AC(config)#interface gigabitEthernet 1/0/3
AC(config-if-GigabitEthernet 1/0/3)#no switchport
```

```
AC(config-if-GigabitEthernet 1/0/3)# interface gigabitEthernet 2/0/3
AC(config-if-GigabitEthernet 2/0/3)#no switchport
AC(config-if-GigabitEthernet 2/0/3)#exit
AC(config)#virtual-ac domain 100 # domain id # Domain ID indicates the ID specified during VAC deployment.
AC(config-vac-domain)# dual-active detection bfd
AC(config-vac-domain)# dual-active bfd interface GigabitEthernet 1/0/3
AC(config-vac-domain)# dual-active bfd interface GigabitEthernet 2/0/3
Check whether the BFD detection port is in the UP state.
AC(config)# show virtual-ac dual-active bfd
BFD dual-active detection enabled: Yes
BFD dual-active interface configured:
  GigabitEthernet 1/0/3: UP
  GigabitEthernet 2/0/3: UP
```

Configure DAD for the aggregation port. The configuration steps are as follows:

```
AC(config)#virtual-ac domain 100 # domain id # Domain ID indicates the ID specified during VAC deployment.
AC(config-vac-domain)# dual-active detection aggregateport
AC(config-vac-domain)# dual-active interface aggregateport 1
Ruijie(config)# interface aggregateport 1 # Enable DAD forwarding on the uplink switch.
Ruijie(config-if-AggregatePort 1)#dad relay enable
```

Check whether the DAD port on the aggregation port is in the UP state.

```
show virtual-ac dual-active aggregateport
Aggregateport dual-active detection enabled: Yes
Aggregateport dual-active interface configured:
  AggregatePort 1: DOWN
    GigabitEthernet 1/0/8: DOWN
    GigabitEthernet 2/0/8: DOWN
```

5.2.6 Key Configuration Check

- Check whether the MTU of 9216 is configured for VSL ports on the switch.
- Check whether an independent VLAN is configured for VSL links on the switch.
- Check whether the load-sharing policy based on the source and destination IP addresses is configured on the switch.
- Check whether the AC versions are the same, which can be queried by running the **show version** command.
- If SNMP is used, check whether the SNMP cache function is enabled and check whether the OID needs to be added to the cache.

5.2.7 FAQ

5.2.7.1 Can Multiple ACs in Different WANs Form a VAC?

Currently, ACs in different WANs cannot form a VAC. The ACs that form a VAC must connect to the same switch.

5.2.7.2 Can ACs of Different Models Form a VAC?

Currently, ACs of different models cannot form a VAC. Even if WS6008 and WS6108 use the same upgrade file, these two types of ACs cannot form a VAC.

5.2.7.3 Can Two VACs Work in Hot Backup Mode?

Currently, VACs cannot work in hot backup mode.

5.2.7.4 Can VSL Links Be Set Up by Directly Connecting ACs?

If only two ACs form a VAC, the VSL links can be set up by directly connecting the two ACs. If more than two ACs form a VAC, the ACs need to connect to the switch to form the star topology. Multiple ACs cannot be connected in serial mode or ring mode using VSL links.

5.2.7.5 Why VSL Ports Are in the DOWN State When a Member AC Is Added?

When a member AC is added, the **show virtual-ac** command output shows that the member AC is added. However, when the **show interface status** command is run, the VSL port status is **DOWN**. When an AC is added, table entries and wireless configurations need to be synchronized to the AC. VSL ports are in the UP state only after the table entries and wireless configurations are synchronized. This process may take several minutes or longer.

5.2.7.6 How to Solve the Problem of AP Load Imbalance When Switches Form the VSU mode and ACs Form a VAC?

Two subracks form the VSU, and WS cards are inserted to the subracks. By default, local forwarding is preferred on switches forming the VSU, that is, CAPWAP packets of APs will be forwarded to the WS card on the subrack that they pass through, and these APs are associated with the WS card on this subrack. CAPWAP packets of these APs will not be forwarded to the other subrack.

It is recommended that the switches forming the VSU also use the aggregation port, and the loading-sharing of the aggregation port is based on the source and destination IP addresses. In this case, packets of APs will be forwarded to the two subracks in load-sharing mode on the switch, and packets on the two subracks are forwarded to the WS cards in load-sharing mode.

5.2.7.7 How to Add ACs of Different Versions to a VAC?

Currently, ACs of different versions can form a VAC. When this situation occurs, it is recommended that ACs of earlier versions be separately upgraded and then added to the VAC. In the current version, upgrading partial ACs is not supported.

5.3 AC Hot-Backup

5.3.1 Understanding AC Hot-Backup

Overview

Currently, there are two ways to deploy a wireless LAN (WLAN): fit access point (AP) mode and fat AP mode. The fit AP mode has become the mainstream deployment mode. The fit AP mode involves the following wireless devices: access controllers (ACs) and APs. APs are connected with ACs. Users perform configuration on ACs, which then deliver configuration to APs. Through the collaboration protocol CAPWAP defined in RFC5415, ACs and APs can jointly provide WLAN services for users. The protocol specifies that when a CAPWAP connection is established between an AC and APs, a CAPWAP communication tunnel will be established between the AC and each AP. The packets delivered between the AC and each AP are transmitted through the CAPWAP tunnel. As shown in Figure 1, CAPWAP tunnels are P2P unicast tunnels.

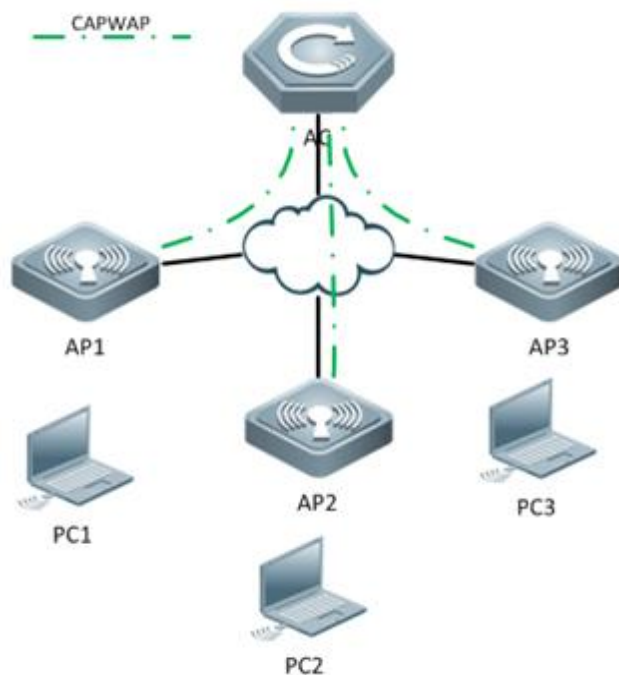

The Ruijie Network AC hot-backup function provides the millisecond-level master/slave switch over capability when the master AC fails, so that services of associated users are nearly not interrupted:

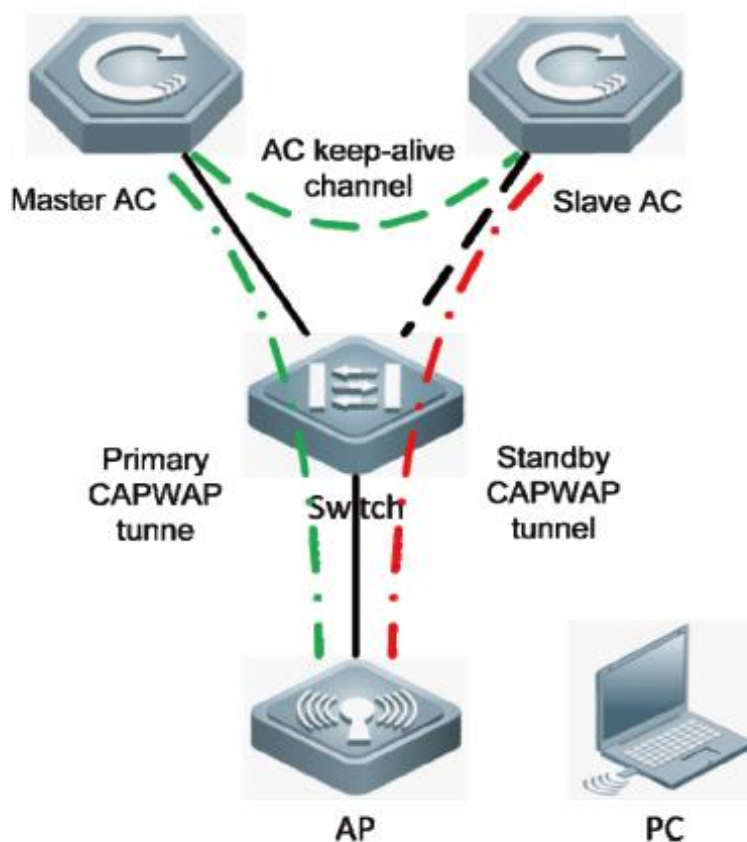

1. The master and slave roles of the two ACs are determined based on negotiation. They keep alive based on the keep-alive mechanism.
2. The AP sets up a primary CAPWAP tunnel with the master AC and sets up a standby one with the slave AC.
3. Users can access the AP through a wireless client.
4. Users can access external networks through the primary CAPWAP tunnel between the AP and the AC.
5. When the master AC fails and the slave AC detects that the keep-alive time expires, the slave AC notifies the AP of the failure.
6. The standby CAPWAP tunnel is activated and the slave AC becomes the master AC.
7. User services are restored after the standby CAPWAP tunnel is activated.
8. When the original master AC recovers, it re-establishes a hot backup association with the original slave AC. The original master AC becomes the slave AC and the AP sets up a standby tunnel with the AC, so that users' services are nearly not interrupted.

Attentions: ACs communicate with each other through a Layer 3 keep-alive tunnel. When the hot-standby topology is designed, the link between ACs must remain accessible.

The AC hot-backup has two modes: active/standby (A/S) and active/active (A/A) mode.

1. A/S Mode

In A/S mode, the AC in the active state is the master device, and the other in the standby state is the slave device. The master AC processes all services, and transmits information about service status to the slave AC for backup, while the slave AC is responsible only for the backup. In this mode, all APs set up primary CAPWAP tunnels with the master AC, and standby tunnels with the slave AC. When the two ACs work properly, the master AC processes all services. If the master AC fails, all services are switched to the slave AC.

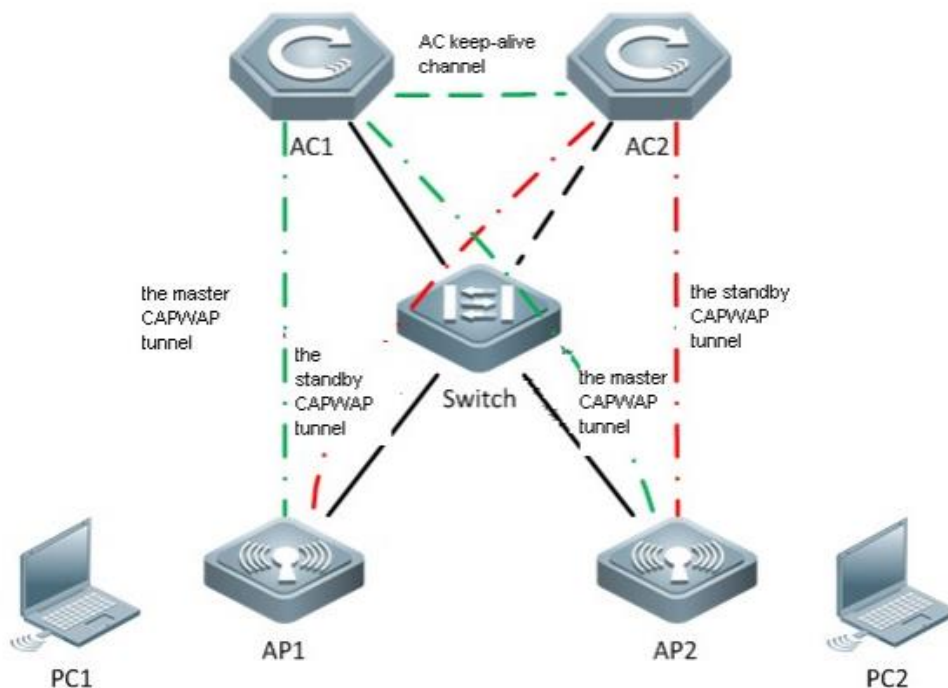

2. A/A Mode

In A/A mode, both ACs process services as the master devices and each serves as the backup of the peer AC. Assume that the two ACs are AC 1 and AC 2. In A/A mode, some APs set up primary CAPWAP tunnels with AC 1 and standby CAPWAP tunnels with AC 2, while others set up primary CAPWAP tunnels with AC 2 and standby CAPWAP tunnels with AC 1. When the two ACs work properly, they process services of the APs that set up primary CAPWAP tunnels with them. If AC 1 fails, the services of the APs are switched to standby CAPWAP tunnels and are taken over by AC 2.

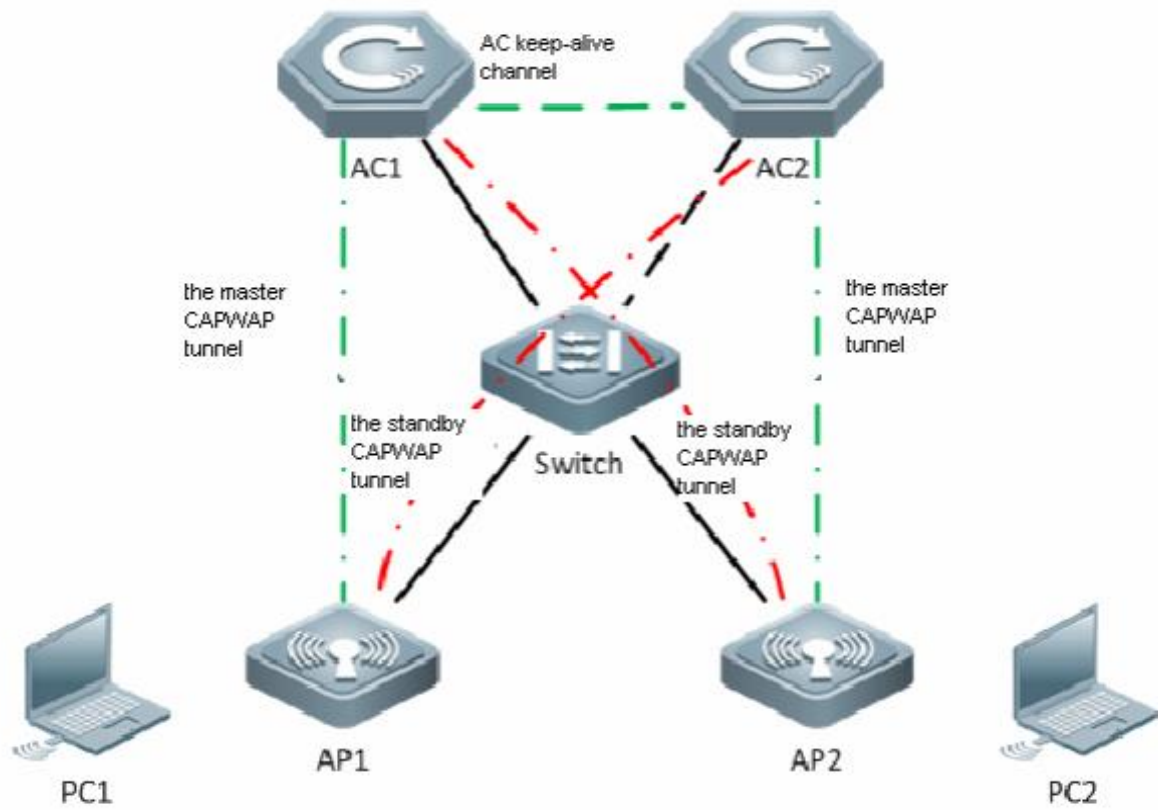

5.3.2 Configuring AC Hot-Backup

I. Requirements

Notes: The configuration of Hot AC and Backup AC should be the same. The AC Hot-Backup function will not be supported when configuring the Web-auth V1 or lportal.

II. Network Topology

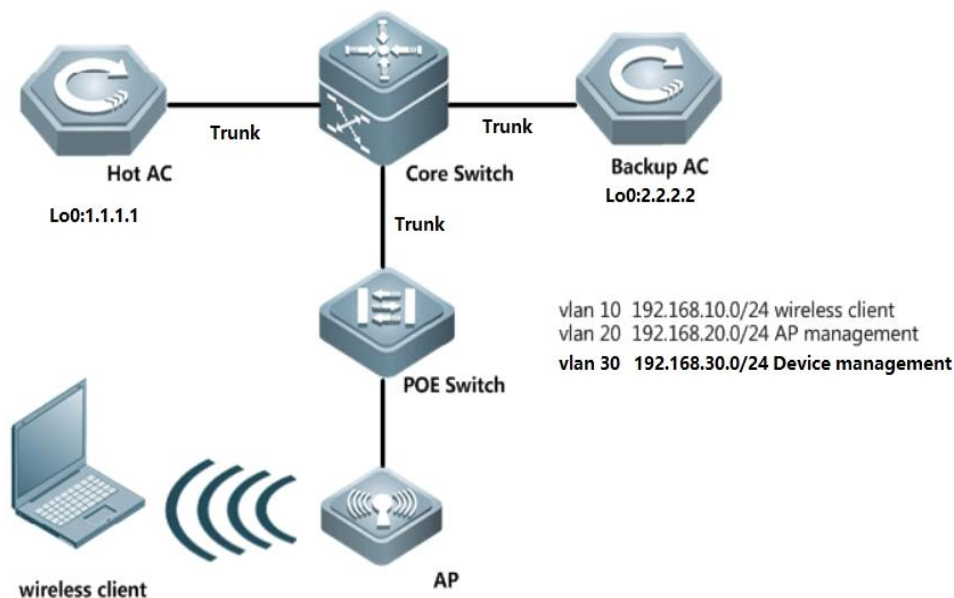

III. Configuration Steps

Configuring AC Hot-Backup

Attention:

- In hot-backup scenario, should assign DHCP Option 138 to AP in below either ways:

```
ip dhcp pool AP
option 138 ip 1.1.1.1 --->1.1.1.1 is loopback port on Hot AC
or
option 138 1.1.1.1 2.2.2.2 --->2.2.2.2 is loopback port on Backup AC
```

- If you want to modify configuration of "ap-group" when Hot-backup is done, suggest modify on Hot AC first, then do the same on Backup AC. When finish modification, suggest reload AP in free time.

- Configuring routes, Hot AC and Backup AC are able to communicate with each other via Loopback port.

Core Switch:

```
Core(config)#ip route 1.1.1.1 255.255.255.255 192.168.30.2
Core(config)#ip route 2.2.2.2 255.255.255.255 192.168.30.3
```

Hot AC:

```
Core(config)#ip route 1.1.1.1 255.255.255.255 192.168.30.2 Hot(config)#ip route 0.0.0.0 0.0.0.0 192.168.30.1
```

Backup AC:

```
Backup(config)#ip route 0.0.0.0 0.0.0.0 192.168.30.1
```

- Configuring AC Hot-backup

Solution 1: Set wireless DHCP on Core Switch, all wireless client point gateway to Core Switch (Recommend)

Hot AC:

```
Hot(config)#wlan-config 1 GroundFloor ----->the configuration on Hot&Backup should be the same
Hot(config)#ap-group ruijie ----->the configuration on Hot&Backup should be the same
Hot(config-ap-group)#interface-mapping 1 10 ----->the configuration on Hot&Backup should be the same ,
even for the sequence if you configure more than 1 interface-mapping
Hot(config-ap-group)#exit
Hot(config)# wlan hot-backup 2.2.2.2 ----->2.2.2.2 is IP address of Backup AC loopback port
Hot(config-hotbackup)# context 10 ----->the configuration on Hot&Backup should be the same
Hot(config-hotbackup-ctx)# priority level 7 ----->configure priority , the bigger number the more prior.
In addition, "7" indicates enable preempt
Hot(config-hotbackup-ctx)# ap-group ruijie
Hot(config-hotbackup)#exit
Hot(config-hotbackup)# wlan hot-backup enable ----->enable hot-backup
```

Note: it can also support to set up hot-backup with non-loopback port (examples below).

```
Ruijie#configure
Enter configuration commands, one per line. End with CNTL/Z.
Ruijie(config)#wlan hot-backup 192.168.120.100
Ruijie(config-hotbackup)#local-ip 192.168.120.110
Ruijie(config-hotbackup)#context 10
Ruijie(config-hotbackup-ctx)#exit
Ruijie(config-hotbackup)#wlan hot-backup enable
```

Backup AC:

```
Backup(config)#wlan-config 1 GroundFloor
Backup(config)#ap-group ruijie
Backup(config-ap-group)#interface-mapping 1 10
Backup(config)# exit
Backup(config)# wlan hot-backup 1.1.1.1
Backup(config-hotbackup)# context 10
Backup(config-hotbackup-ctx)# ap-group ruijie
Backup(config-hotbackup)# exit
Backup(config-hotbackup)# wlan hot-backup enable
```

Add AP on Hot and Backup AC (take AP mac: 0001.0000.0001 for example and assume AP is online):

Hot AC:

```
AC-1(config)#ap-config 0001.0000.0001 ----->AP is online
AC-1(config-ap)#ap-group ruijie
AC-1(config-ap)#ap-name ap320 ----->the AP name need to be same on Hot AC and Backup AC
```

Backup AC:

```
AC-2(config)#ap-config ap320 -----> pre-configuration, AP is offline on Backup AC
```

```
AC-2(config-ap)#ap-mac 0001.0000.0001
AC-2(config-ap)#ap-group ruijie
```

Solution 2: Set wireless DHCP on AC, all wireless client point gateway to AC

Core Switch:

```
Core(config)#ip route 192.168.10.0 255.255.255.0 192.168.30.2 --->192.168.10.0/24 is wireless user IP subnets
Core(config)#ip route 192.168.10.0 255.255.255.0 192.168.30.3
```

Hot AC:

```
Hot(config)#interface VLAN 10
Hot(config-if-VLAN 10)#ip address 192.168.10.2 255.255.255.0
Hot(config-if-VLAN 10)#vrrp 1 ip 192.168.10.1 ----->enable VRRP
Hot(config)#service dhcp
Hot(config)#ip dhcp pool sta ----->DHCP pool for wireless users
Hot(dhcp-config)#network 192.168.10.0 255.255.255.0 192.168.10.4 192.168.10.254 ----->assign IP subnets 192.168.10.0/24 to wireless users,assign IP starts from 192.168.10.4 to 192.168.10.254
Hot(dhcp-config)# dns-server 8.8.8.8
Hot(dhcp-config)# default-router 192.168.10.1
Hot(config)#ap-group ruijie
Hot(config-ap-group)#interface-mapping 1 10 ----->the configuration on Hot&Backup should be the same , even for the sequence if you configure more than 1 interface-mapping)
Hot(config-ap-group)#exit
Hot(config)#wlan hot-backup 2.2.2.2 ----->2.2.2.2 is IP address of Backup AC loopback port
Hot(config-hotbackup)# context 10 ----->the configuration on Hot&Backup should be the same
Hot(config-hotbackup-ctx)# priority level 7 ----->configure priority, the bigger number the more prior. In addition, "7" indicates enable preempt
Hot(config-hotbackup-ctx)# ap-group ruijie
Hot(config-hotbackup-ctx)# dhcp-pool sta ----->set DHCP hot-backup. DHCP server on Backup AC will not respond when Hot AC is alive
Hot(config-hotbackup-ctx)# vrrp interface vlan 10 group 1 ----->set Gateway hot-backup. VRRP status on Backup AC will remain in "Init" when Hot AC is alive.
Hot(config-hotbackup-ctx)# exit
Hot(config-hotbackup)# wlan hot-backup enable ----->enable Hot-backup
```

Backup AC:

```
Backup(config)#interface VLAN 10
Backup(config-if-VLAN 10)#ip address 192.168.10.3 255.255.255.0
Backup(config-if-VLAN 10)# vrrp 1 ip 192.168.10.1
Backup(config)#service dhcp
Backup(config)#ip dhcp pool sta
```

```

Backup(dhcp-config)#network 192.168.10.0 255.255.255.0 192.168.10.4 192.168.10.254
Backup(dhcp-config)# dns-server 8.8.8.8
Backup(dhcp-config)# default-router 192.168.10.1
Backup(config)#ap-group ruijie
Backup(config-ap-group)#interface-mapping 1 10
Backup(config-ap-group)#exit
Backup(config)#wlan hot-backup 1.1.1.1
Backup(config-hotbackup)# context 10
Backup(config-hotbackup-ctx)# ap-group ruijie
Backup(config-hotbackup-ctx)# dhcp-pool sta
Backup(config-hotbackup-ctx)# vrrp interface vlan 10 group 1
Backup(config-hotbackup-ctx)#exit
Backup(config-hotbackup)# wlan hot-backup enable

```

Add AP on Hot and Backup AC (take AP mac: 0001.0000.0001 for example and assume AP is online):

Hot AC:

```

AC-1(config)#ap-config 0001.0000.0001 ----->AP is online
AC-1(config-ap)#ap-group ruijie
AC-1(config-ap)#ap-name ap320 ----->the AP name need to be same on Hot AC and Backup AC

```

Backup AC:

```

AC-2(config)#ap-config ap320 -----> pre-configuration, AP is offline on Backup AC
AC-2(config-ap)#ap-mac 0001.0000.0001
AC-2(config-ap)#ap-group ruijie

```

IV. Verification

1. Display Hot-backup status, execute commands "show wlan hot-backup". The connect state should be "CHANNEL_UP " if it works properly

```

Hot#show wlan hot-backup 2.2.2.2
wlan hot-backup 2.2.2.2
 hot-backup      : Enable
 connect state  : CHANNEL_UP
 hello-interval : 1000
 kplv-pkt       : ip
 work-mode      : NORMAL
 !
 context 10
  hot-backup role      : PAIR-ACTIVE
  hot-backup rdnd state : REALTIME-SYN
  hot-backup priority  : 7
  ap-group             : ruijie

```

```

dhcp-pool          : sta
vrrp interface - group: VLAN 10 - 1

Backup#show wlan hot-backup 1.1.1.1
wlan hot-backup 1.1.1.1
hot-backup        : Enable
connect state     : CHANNEL_UP
hello-interval: 1000
kplv-pkt         : ip
work-mode         : NORMAL
!
context 10
hot-backup role   : PAIR-STANDBY
hot-backup rdnd state : REALTIME-SYN
hot-backup priority : 4
ap-group          : ruijie
dhcp-pool         : sta
vrrp interface - group: VLAN 10 - 1

```

2. Login AP, display capwap status, and execute commands "show capwap status". There exists two CAPWAP tunnels meanwhile.

```

Ruijie#show cap stat
CAPWAP tunnel state, 4 peers, 2 is run:
Index   Peer IP      Port   State
0       1.1.1.1     5246   Run
1       2.2.2.2     5246   Run
2       ::          5246   Idle
3       ::          5246   Idle

```

You can also execute commands " show capwap status | inc master" to check the master ac.

3. Display vrrp status, execute command "show vrrp interface vlan 10 brief".

```

Hot#show vrrp int vlan 10 brief
Interface          Grp Pri timer Own Pre  State  Master addr          Group addr
VLAN 10           1  100 3        -  P    Master 192.168.10.2
192.168.10.1

Backup#show vrrp brief
Interface          Grp Pri timer Own Pre State  Master addr          Group addr
VLAN 10           1  100 3        -  P    Init   0.0.0.0
192.168.10.1

```

4. Connect wireless client to WLAN, conduct long ping as below diagram, then simulate Hot AC interruption by reloading or power off.

Backup AC should take over and there should be only several packets loss.

Attention: Original Hot AC will take over back to Hot in 10 minutes after finish reloading.

Hot AC will not take over if you do not set priority level to "7"

```
Reply from 192.168.10.1: bytes=32 time=47ms TTL=53
Reply from 192.168.10.1: bytes=32 time=54ms TTL=53
Reply from 192.168.10.1: bytes=32 time=64ms TTL=53
Reply from 192.168.10.1: bytes=32 time=49ms TTL=53
Reply from 192.168.10.1: bytes=32 time=84ms TTL=53
Reply from 192.168.10.1: bytes=32 time=52ms TTL=53
Reply from 192.168.10.1: bytes=32 time=48ms TTL=53
Reply from 192.168.10.1: bytes=32 time=46ms TTL=53
Reply from 192.168.10.1: bytes=32 time=58ms TTL=53
Reply from 192.168.10.1: bytes=32 time=73ms TTL=53
Request timed out.
Reply from 192.168.10.1: bytes=32 time=62ms TTL=53
Reply from 192.168.10.1: bytes=32 time=59ms TTL=53
Reply from 192.168.10.1: bytes=32 time=67ms TTL=53
Reply from 192.168.10.1: bytes=32 time=51ms TTL=53
Reply from 192.168.10.1: bytes=32 time=62ms TTL=53
Reply from 192.168.10.1: bytes=32 time=86ms TTL=53
```

5.4 AC-Cluster

5.4.1 Understanding AC Cluster

Overview

Cluster means a group of coordinated service entities that provide more expandable and usable services platform than a single service entity. In a WLAN project, cluster means a group of coordinated ACs. Compared with the single-AC model, a group of coordinated ACs (cluster) provides higher usability (redundancy fault recovery) and load balancing.

AC Redundancy

In order to provide services for wireless users, AP must maintain connection with a specific AC. If this AC fails suddenly, AP will be unable to connect to AC and the service will fail. To enhance serviceability, the feature of AC redundancy is introduced. AC redundancy assigns multiple ACs to the AP. When one AC fails, the AP can use the backup AC. AC redundancy well improves the reliability of AC cluster and avoid the circumstance that the downlink AP cannot provide services due to the failure of certain AC.

AC to Support the Failover Priority of AP

Generally, when the connection between AP and AC fails, the AP will look for the backup AC. By default, AP is connected to

AC according to the sequence of association requests arrived. Failover Priority can help specify the priority level for AP, so that AC can accept the access request of AP according to the priority level of AP, ensuring that high-priority APs can be given the priority to connect to AC.

When the number of APs connected to AC has reached the threshold, if a new AP requests to associate with this AC and its priority level is higher than some connected APs, then AC will randomly kick out one AP among those associated APs with the lowest priority level. In this way, the new AP can then associate with this AC.

Difference to AC Hot-backup

Advantage: Both AC-1 and AC-2 forwards traffic in load balance way.

Disadvantage: It costs longer time than Hot-backup if AC-1 is down then switch the traffic to AC-2

5.4.2 Configuring AC Cluster

I. Network Topology

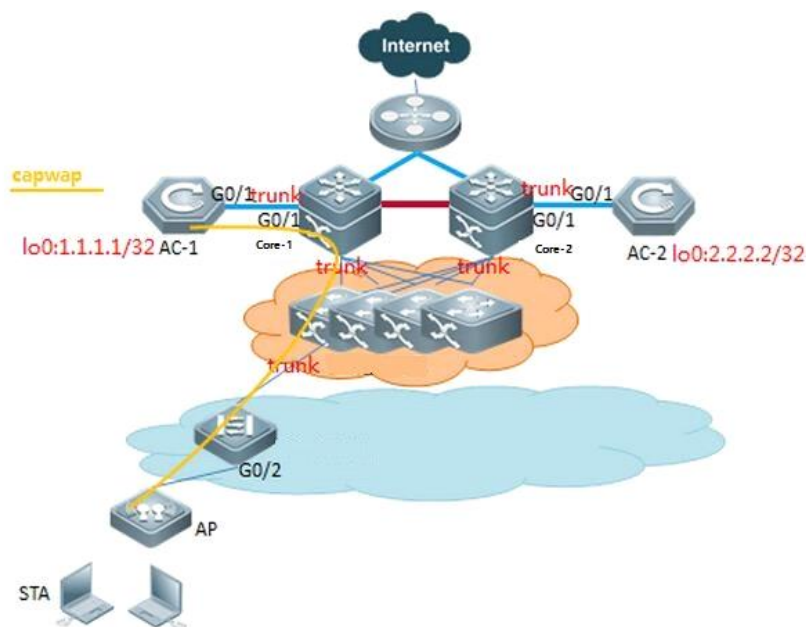

AC-1 is primary and AC-2 is secondary. AP establishes CAPWAP with AC-1. When AC-1 fails, the AP can use the backup AC-2.

II. Configuration Steps

1. Wlan basic configuration

Please view Basic Feature--Fit AP configuration section

2. Configuring AC Cluster(wlan-config ap-group and ap-name need to be the same)

AC-1:

```
AC-1(config)#interface loopback 0
AC-1(config-if-Loopback 1)#ip address 1.1.1.1 255.255.255.0
```



```
AC-1(config-if-Loopback 1)#exit
AC-1(config)#ac-controller
AC-1(config-ac)#ac-name AC-1
AC-1(config-ac)#exit
AC-1(config)#ap-config 0001.0001.0001 --->assume 0001.0001.0001 is AP MAC address, and it's the first time
to configure AP
You are going to config AP(0001.0001.0001), which is online now.
AC-1(config)# ap-name AP
AC-1(config-ap)#ap-group ruijie
AC-1(config-ap)#primary-base AC-1 1.1.1.1
AC-1(config-ap)#secondary-base AC-2 2.2.2.2
```

AC-2:

```
AC-2(config)#interface loopback 0
AC-2(config-if-Loopback 1)#ip address 2.2.2.2 255.255.255.0
AC-2(config-if-Loopback 1)#exit
AC-2(config)#ac-controller
AC-2(config-ac)#ac-name AC-2
AC-2(config-ac)#exit
AC-2(config)#ap-config 0001.0001.0001
AC-2(config)# ap-name AP
AC-2(config-ap)#ap-group ruijie
AC-2(config-ap)#primary-base AC-1 1.1.1.1
AC-2(config-ap)#secondary-base AC-2 2.2.2.2
```

III. Verification

Connect wireless client to Wlan, simulate AC-1 interruption by reloading or power off, wireless client should be able to get wlan services in seconds.

5.5 Time Schedule

5.5.1 Turn off LED in Fixed Time

I. Requirements

Client wants to turn off AP LED in fixed time everyday automatically

II. Network Topology

AC loopback0:1.1.1.1/32

AP:192.168.20.0/24

STA:172.16.1.0/24

AC:192.168.1.0/24

STA vlan 10

AP vlan 20

AC vlan 30

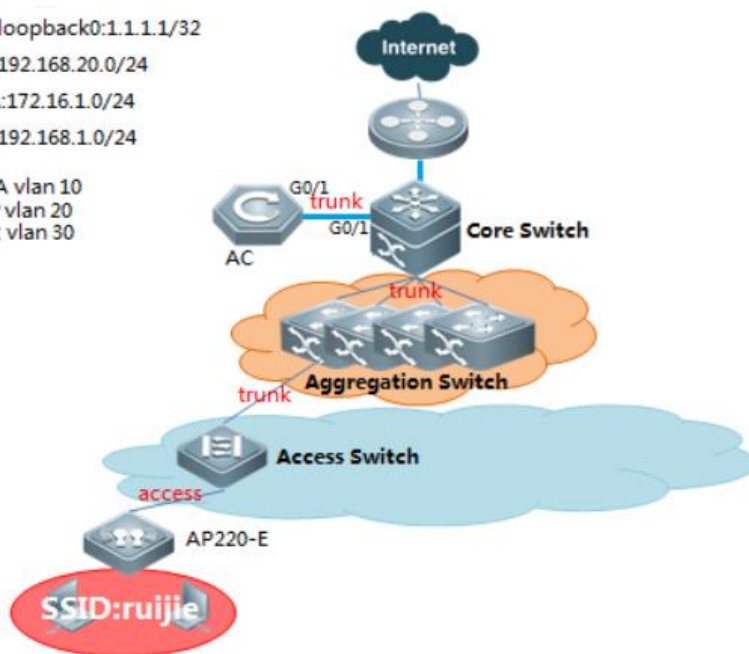

III. Configuration Steps

Configuring turn off AP LED in fixed time

Fit AP

Configuring on AC

```

AC>enable
AC#configure terminal
AC(config)#schedule session 1
AC(config)#schedule session 1 time-range 1 period Wed time 13:30 to 20:20 ----->time range from 13:30 to 20:20 on Wednesday
AC(config)#clock timezone UTC +8 ---> set time zone, +8 hours offset
AC#clock set 11:33:00 8 6 2014 ---->set current time 11:33:00 6th Aug 2014
AC#show clock
AC#configure terminal
AC(config)#ap-config all
AC(config-ap)#quiet-mode session 1
AC(config-ap)#end
Recommend configure sntp, or the clock will return to the factory after reboot AP
AC(config)#sntp enable ----->enable sntp service
AC(config)#sntp server 192.168.2.1 ----->configure sntp server
AC#write

```

Fat AP

Configuring on Fat AP

```
FatAP>enable
FatAP#configure terminal
FatAP(config)#schedule session 1
FatAP(config)#schedule session 1 time-range 1 period Wed time 13:30 to 20:20
FatAP(config)#clock timezone UTC +8 ---> set time zone, +8 hours offset
FatAP#clock set 11:33:00 8 6 2014
FatAP#show clock
FatAP#configure terminal
FatAP(config)#quiet-mode session 1
FatAP(config-ap)#end
Recommend configure sntp, or the clock will return to the factory after reboot AP
FatAP(config)#sntp enable ---->enable sntp service
FatAP(config)#sntp server 192.168.2.1 ---->configure sntp server
FatAP#write
```

IV. Verification

1. ALL the LED, sys, wlan & wan LED on AP, are turned off
2. System prompts logs when quiet-mode takes effect:
[Wed, 13:55] Disable by schedule.

5.5.2 Turn off Radio in Fixed Time

I. Requirements

Client wants to turn off Radio in fixed time everyday automatically

II. Network Topology

AC loopback0:1.1.1.1/32

AP:192.168.20.0/24

STA:172.16.1.0/24

AC:192.168.1.0/24

STA vlan 10

AP vlan 20

AC vlan 30

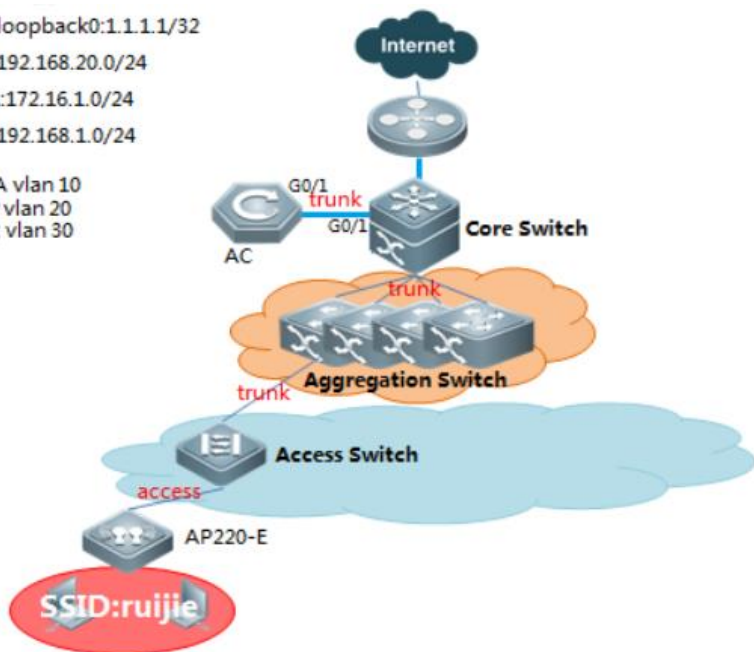

III. Configuration Steps

Configuring turn off Radio in fixed time

Fit AP

Configuring on AC

```
AC>enable
AC#configure terminal
AC(config)#schedule session 1
AC(config)#schedule session 1 time-range 1 period Wed time 13:30 to 20:20 ----->time range from 13:30 to 20:20 on Wednesday
AC(config)#clock timezone UTC +8 ----> set time zone, +8 hours offset
AC#clock set 11:33:00 8 6 2014 ---->set current time 11:33:00 6th Aug 2014
AC#show clock
AC#write
```

Below settings depends:

1. Turn off a certain WLAN

```
AC(config)#wlan-config 1
AC(config-wlan)# schedule session 1
```

2. Turn off a single Radio on a certain AP

```
AC(config)#ap-config 001a.a9120.ac09
AC(config-ap)#schedule session 1 radio 1
```

3. Turn off a single Radio on a group of APs

```
AC(config)#ap-group ruijie
AC(config-ap-group)#schedule session 1 radio 1
```

4. **Recommend configure sntp, or the clock will return to the factory after reboot AP**

```
AC(config)#sntp enable ----->enable sntp service
AC(config)#sntp server 192.168.2.1 ----->configure sntp server
AC#write
```

Fat AP

Configuring on Fat AP

```
FatAP>enable
FatAP#configure terminal
FatAP(config)#schedule session 1
FatAP(config)#schedule session 1 time-range 1 period Wed time 13:30 to 20:20
FatAP(config)#clock timezone UTC +8 ---> set time zone, +8 hours offset
FatAP#clock set 11:33:00 8 6 2014 --->set current time 11:33:00 6th Aug 2014
FatAP#show clock
FatAP#write
```

Below settings depends:

1. Turn off a certain WLAN

```
FatAP(config)#schedule session 1 wlan 1
```

2. Turn off a single Radio

```
FatAP(config)#ap-group ruijie
FatAP(config-ap-group)#schedule session 1 radio 1
```

3. **Recommend configure sntp, or the clock will return to the factory after reboot AP**

```
FatAP(config)#sntp enable ----->enable sntp service
FatAP(config)#sntp server 192.168.2.1 ----->configure sntp server
FatAP#write
```

IV. Verification

1. No wireless signal from 13:30 to 20:20 on Wednesday
2. Display ssid status, execute command on Fat or Fit AP "show dot11 mbssid". No output in the time range from 13:30 to 20:20 on Wednesday

```
Ruijie#show dot11 mbssid
```

3. System prompts below logs:

```
Ruijie(config)#00:00:11:01: %7: [Wed, 13:30] Disable wlan 1 by schedule.
```

```
Ruijie(config)#00:00:13:01: %7: [Wed, 20:20] Enable wlan 1 by schedule.
```

5.6 Wireless Multicast

I. Requirements

Have basic knowledge of IP multicast, IGMP Snooping and PIM (Protocol Independent Multicast).

II. Network Topology

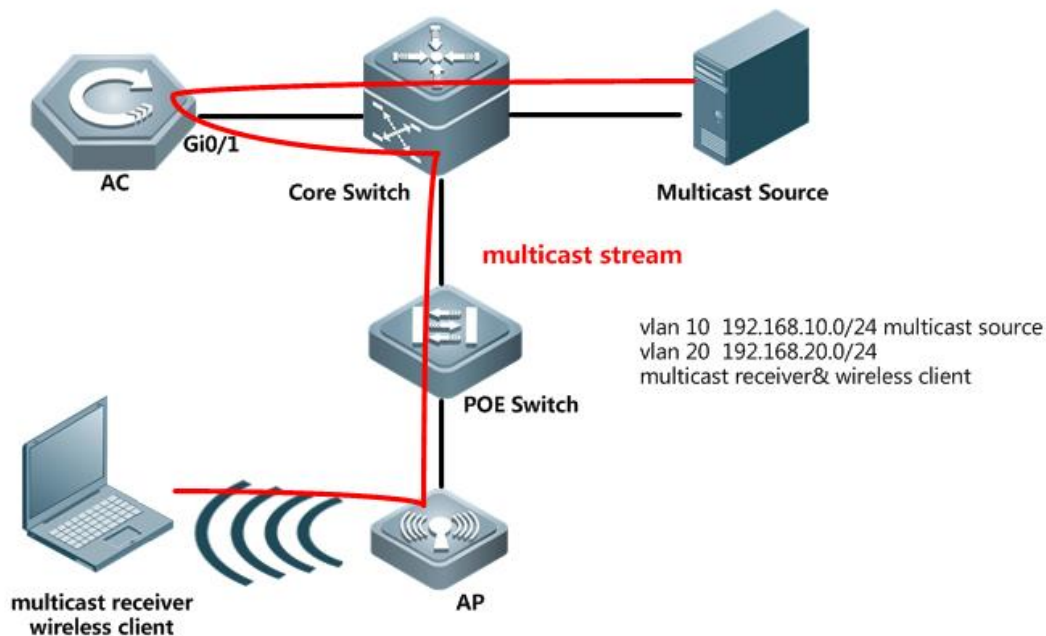

III. Configuration Steps

Configuring Wireless Multicast

AC

```
AC(config)#ip multicast wlan          --->enable ip multicast globally
AC(config)#ip igmp snooping          --->enable ip igmp snooping globally (require IP PIM enabled on
Core Switch)
AC(config)#ap-config ap220-e         --->enable ip igmp snooping on a specific AP
AC(config-ap)#igmp snooping
AC(config)#data-plane wireless-broadcast enable
```

Core Switch

```
CoreSwitch(config)#ip multicast-routing --->enable ip multicast
```

```
CoreSwitch(config)#interface vlan 10
CoreSwitch(config-VLAN 10)#ip pim dense-mode --->enable PIM
CoreSwitch(config)#interface vlan 50
CoreSwitch(config-VLAN 50)#ip pim dense-mode --->enable PIM
```

Notes: If the multicast doesn't in the same subnet or use spare mode, it needs to configure multicast RP role.

IV. Verification

Prepare multibase source and receiver, pump in multicast traffic and display IGMP Snooping status on AC, execute command "show ip igmp snooping mroute" and "show ip igmp snooping group"

Tips: you may simulate multicast traffic with tools "Wsend" and "Wlisten"

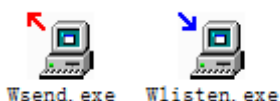

```
AC-1#show ip igmp snooping mrouter
Multicast Switching Cache Table
D: DYNAMIC
S: STATIC
(*, *, 10):
VLAN(10) 1 MROUTES:
GigabitEthernet 0/1(D)
```

G0/1 port receive IGMP query

```
AC-1#show ip igmp snooping group
Multicast Switching Cache Table
D: DYNAMIC
S: STATIC
M: MROUTE
(*, 239.255.255.250, 10):
VLAN(10) 2 OPORTS:
GigabitEthernet 0/1(M)
CAPWAP-Tunnel 1(D)
(*, 239.0.0.1, 10):
VLAN(10) 2 OPORTS:
GigabitEthernet 0/1(M)
CAPWAP-Tunnel 1(D)
```

(M) indicates multicast traffic uplink port
(D) indicates multicast traffic downlink port

Also, display IGMP Snooping state on AP, execute command "show ip igmp snooping mroute" and "show ip igmp snooping gda-table"

```
Ruijie>show ip igmp snooping mrouter
Multicast Switching Cache Table
D: DYNAMIC
S: STATIC
(*, *, 10):
VLAN(10) 1 MROUTES:
CAPWAP-Tunnel 1(D)
```

CAPWAP tunnel port receive IGMP query

```

Ruijie>show ip igmp snooping group
Multicast Switching Cache Table
  D: DYNAMIC
  S: STATIC
  M: MROUTE
(*, 239.255.255.250, 10):
  VLAN(10) 2 OPORTS:
    CAPWAP-Tunnel 1(M) (M) indicates multicast traffic uplink port
    Dot11radio 2/0.1(D)
(*, 239.0.0.1, 10):
  VLAN(10) 2 OPORTS:
    CAPWAP-Tunnel 1(M) (D) indicates multicast traffic downlink
    Dot11radio 2/0.1(D) port

```

5.6.1 FAQ

5.6.1.1 How to adjust the wireless multicast packet sending rate

In fat mode:

```
Ruijie(config)#interface dot11radio 1/0
```

```
Ruijie(config-if-Dot11radio 1/0)#mcast_rate 54 ----->Adjusts the multicast rate to 54Mbps.
```

In fit mode:

```
Ruijie(config)#wlan-conf 1 wireless
```

```
Ruijie(config-wlan)#mcast_rate 54 ----->Adjusts the multicast rate to 54 Mbps.
```

5.6.1.2 How to configure the multicast-to-unicast function

The multicast-to-unicast function is used to make multicast video smoother.

Configuration reference:

(1) Enable the multicast routing protocol in a Layer-3 device in the same broadcast domain.

(2)

In fit (ap-config) mode, run the following command:

```
Ruijie(config)# ip igmp snooping ----->Enables igmp snooping for all VLANs. To enable this function for certain VLANs, run the ip igmp snooping vlan 1 command.
```

```
Ruijie(config)#ap-config xxx
```

```
Ruijie(config-ap)# igmp snooping mcast-to-unicast enable
```

```
Ruijie(config-ap)# igmp snooping mcast-to-unicast group-range ip-addr ip-addr ----->(Optional) Defines the multicast-to-unicast scope.
```

In fat mode, run the following command:

```
Ruijie(config)#ip igmp snooping ----->Enables igmp snooping for all VLANs. To enable this function for certain VLANs, run the ip igmp snooping vlan 1 command.
```



```
Ruijie(config)#ip igmp snooping mcast-to-unicast enable
```

5.6.1.3 Does AC support Layer-3 multicast?

No. But AC can transparently transmit Layer-2 multicast packets.

5.6.1.4 How to check whether CAPWAP multicast is enabled on AC or AP

```
Ruijie# show ip multicast wlan
```

```
Global multicast state: enable           // Enables global multicast mode.
```

```
Multicast mode:multicast 239.0.0.1 // Enables CAPWAP multicast mode.
```

5.7 Local Forwarding

I. Requirements

Finish reading

Have knowledge of the difference between Centralized and Local forwarding

Attention: In Roaming scenario, all APs IP address should be in a same IP subnets and brocast domain

II. Network Topology

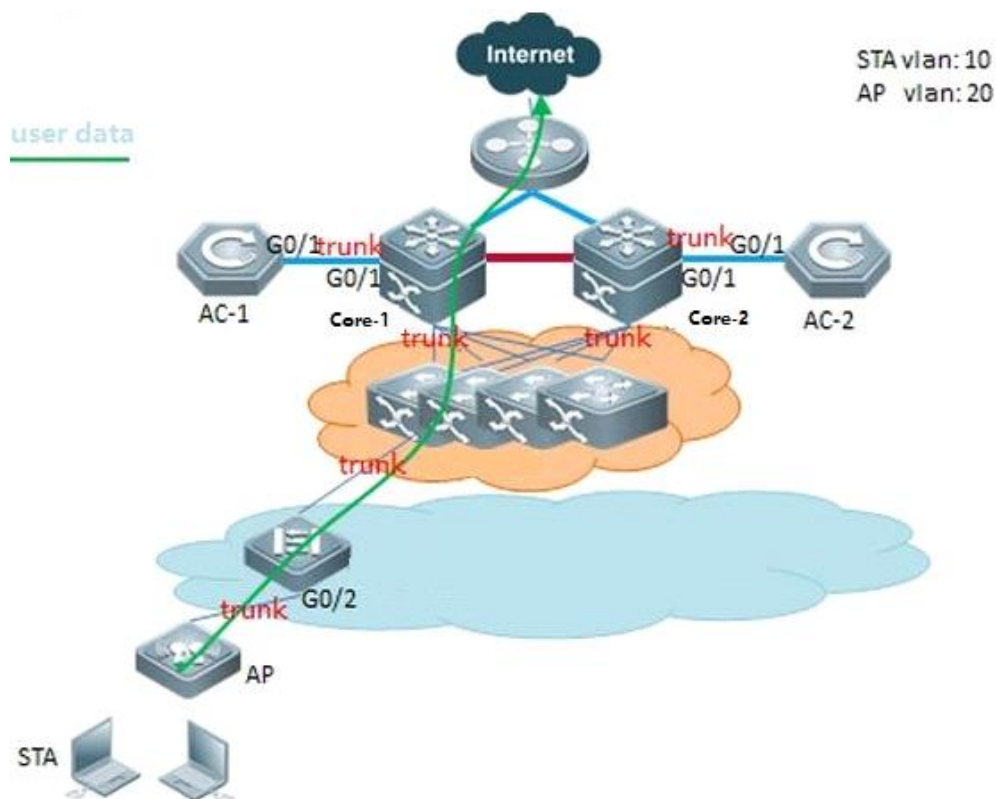

III. Configuration Steps

Configuring Local Forwarding

POE Switch

```
POESwtich(config)#interface gigabitEthernet 0/2
POESwtich(config-GigabitEthernet 0/2)#switchport mode trunk
POESwtich(config-GigabitEthernet 0/2)#switchport trunk native vlan 20 --->20 is AP management Vlan
POESwtich(config-GigabitEthernet 0/2)#switchport trunk allowed vlan remove 1-9,11-19,21-4094 --->Prune all
vians except for AP management Vlan and user data Vlan
```

AC

```
AC(config)#wlan-config 1 ruijie
AC(config-wlan)#tunnel local ----->enable local forwarding in WLAN 1
AC(config)#ap-group ruijie
AC(config-ap-group)#no interface-mapping 1 10 ----->all wireless user under this ap-group will be forced
offline
AC(config-ap-group)#interface-mapping 1 10 --->Reassociate WLAN ID and VLAN ID to make configuration
effect
```

IV. Verification

1. On AP, execute command "show run interface dot11radio 1/0", the mac-mode should be local

```
interface Dot11radio 1/0.1
 encapsulation dot1Q 10
 mac-mode local
 slottime short
 mcast_rate 54
```

2. POESwitch learns the MAC address of wireless users on the downlink port that connects to AP

Vlan	MAC Address	Type	Interface
10	0000.5e00.0101	DYNAMIC	GigabitEthernet 0/1
10	001a.a97e.9dce	DYNAMIC	GigabitEthernet 0/1
10	001a.a9bc.179f	DYNAMIC	GigabitEthernet 0/3
10	0026.c763.3310	DYNAMIC	GigabitEthernet 0/1
10	0811.9692.244c	DYNAMIC	GigabitEthernet 0/2
20	001a.a94e.d52a	DYNAMIC	GigabitEthernet 0/2
30	0000.5e00.0101	DYNAMIC	GigabitEthernet 0/1
30	001a.a97e.9dce	DYNAMIC	GigabitEthernet 0/1
30	001a.a9bc.179f	DYNAMIC	GigabitEthernet 0/3

5.8 Wireless Authentication

5.8.1 802.1X Authentication

5.8.1.1 Understanding MAB on Wireless Device

In an IEEE 802 LAN, users can access the network device without authorization and authorization as long as they are connected to the network device. Therefore, an unauthorized user can access the network unobstructed by connecting the LAN. As the wide application of LAN technology, particularly the appearance of the operating network, it is necessary to address the safety authentication needs of the network. It has become the focus of concerns in the industry that how to provide user with the authentication on the legality of network or device access on the basis of simple and cheap LAN technologies. The IEEE 802.1x protocol is developed under such a context.

As a Port-Based Network Access Control standard, the IEEE802.1x provides LAN access point-to-point security access. Specially designed by the IEEE Standardization Commission to tackle the safety defects of Ethernet, this standard can provide a means to authenticate the devices and users connected to the LAN by utilizing the advantages of IEEE 802 LAN. The IEEE 802.1x defines a mode based on Client-Server to restrict unauthorized users from accessing the network. Before a client can access the network, it must first pass the authentication of the authentication server. Before the client passes the authentication, only the EAPOL (Extensible Authentication Protocol over LAN) packets can be transmitted over the network. After successful authentication, normal data streams can be transmitted over the network.

In the IEEE802.1x standard, there are three roles: supplicant, authenticator, and authentication server. In practice, they are the Client, network access server (NAS) and Radius-Server.

**Supplicant:**

The supplicant is a role played by the end user, usually a PC. It requests for the access to network services and acknowledges the request packets from the authenticator. The supplicant must run the IEEE 802.1x client. Currently, the most popular one is the IEEE802.1x client carried by Windows XP. In addition, we have also launched the STAR Supplicant software compliant of this standard.

Authenticator:

The authenticator is usually an access device like the switch, AP or AC. The responsibility of the device is to control the connection status between client and the network according to the current authentication status of that client. Between the client and server, this device plays the role of a mediator, which requests the client for username, verifies the authentication information from the server, and forwards it to the client. Therefore, the switch acts as both the IEEE802.1x Authenticator and the RADIUS Client, so it is referred to as the network access server (NAS). It encapsulates the acknowledgement received from the client into the RADIUS format packets and forwards them to the RADIUS Server, while resolving the information received from the RADIUS Server and forwards the information to the client. The device acting as the authenticator has two types of ports: controlled Port and uncontrolled Port. The users connected to a controlled port can only access network resources after passing the authentication, while those connected to a uncontrolled port can directly access network resources without authentication. We can control users by simply connecting them to an controlled port. On the other hand, the uncontrolled port is used to connect the authentication server, for ensuring normal communication between the server and switch.

Authentication server:

The authentication server is usually an RADIUS server, which works with the authenticator to provide users with authentication services. The authentication server saves the user name and password and related authorization information. One server can provide authentication services for multiple authenticators, thus allowing centralized management of users. The authentication server also manages the accounting data from the authenticator. Our 802.1x device is fully compatible with the standard Radius Server, for example, the Radius Server carried on Microsoft WindowsServer and the Free Radius Server on Linux. In addition, we have already introduced the Radius server software SAM (Security Accounting Management Platform) complying with standards.

The supplicant and the authenticator exchange information by EAPOL protocol, while the authenticator and authentication server exchange information by RADIUS protocol, completing the authentication process with such a conversion. The EAPOL

protocol is encapsulated on the MAC layer, with the type number of 0x888E. In addition, the standard has required for an MAC address (01-80-C2-00-00-03) for the protocol for packet exchange during the initial authentication process.

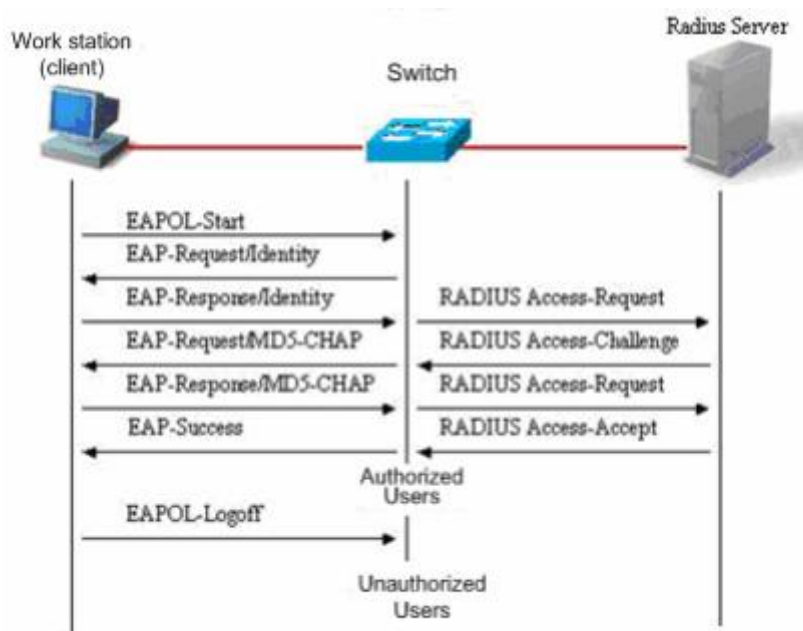

This is a typical authentication process initiated by users (in some special cases, the switch can actively initiate authentication request, whose process is the same as that shown in the diagram, except that it does not contain the step where the user actively initiates the request).

5.8.1.2 Configuring 802.1X Authentication

I. Network Topology

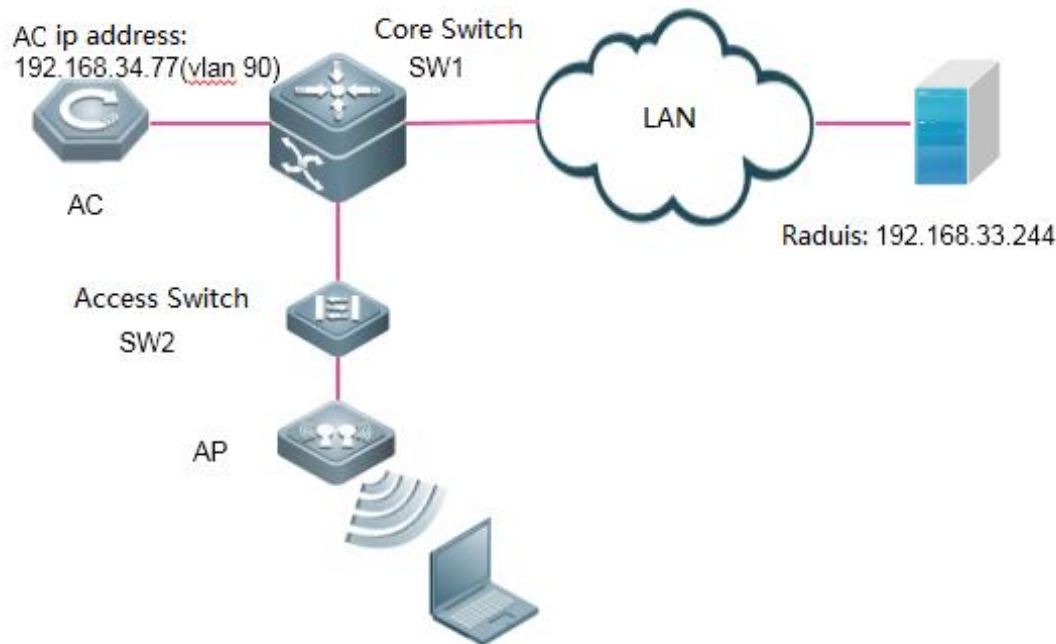

II. Configuration Steps

1. Enable 802.1x AAA authentication

```
AC-1(config)#aaa new-model ---->enable AAA authentication
```

```
AC-1(config)#aaa authentication dot1x default group radius ---->define the default group of dot1x authentication
```

```
AC-1(config)#aaa accounting network default start-stop group radius ---->define the default group of aaa accounting
```

2. Configure Radius server's IP address and KEY

```
AC-1(config)#radius-server host 192.168.33.244 key ruijie ----> configure ip address and key of radius server
```

```
AC-1(config)#ip radius source-interface bvi 90 ----> AC communicate with radius using the IP address of vlan 90
```

3. Configure parameters of 802.1x authentication

```
AC-1(config)#dot1x authentication default ----> use default list for dot1x authentication
```

```
AC-1(config)#dot1x accounting default ----> use default list for dot1x accounting
```

```
AC-1(config)#dot1x eapol-tag ----> make AC able to process authentication packets with VLAN tag
```

4. Enable 802.1X authentication

```
AC-1(config)#wlansec 1 ----> enable authentication on wlan 1
```

```
AC-1(config-wlansec)# security rsn enable
```

```
AC-1(config-wlansec)# security rsn ciphers aes enable
```

```
AC-1(config-wlansec)# security rsn akm 802.1x enable
```

5. Configure SNMP

```
AC-1(config)#snmp-server host 192.168.33.244 traps version 2c ruijie
```

```
AC-1(config)#snmp-server enable traps
```

```
AC-1(config)#snmp-server community ruijie rw
```

6. Configuring Portal Server and Radius Server

SMP:

1. Login to SMP server ---> "Authentication & Authority" ---> "Device" ---> "NAS Configuration Templates"

The screenshot shows the RG-SMP Security Management Platform Professional interface. The left sidebar has a 'Device' menu item highlighted with a red box. The main content area shows the 'NAS Configuration Templates' section, with a 'NAS Configuration Templates' link highlighted in a red box. Below this, there is a table of NAS Configuration Templates.

All None	NAS IP	NAS MAC	NAS Configuration Templates	Operation
<input type="checkbox"/>	10.10.1.31	58696c14fbc	Ruijie Switch Device	Telnet View Modify
<input type="checkbox"/>	10.10.1.63	14144b57189	Ruijie Wred Device	Telnet View Modify
<input type="checkbox"/>	172.29.3.1	58696c20ba84	Ruijie Wireless Device	Telnet View Modify
<input type="checkbox"/>	172.29.3.18	14144b751127	Ruijie Wred Device	Telnet View Modify
<input type="checkbox"/>	172.29.3.2	58696c153dfa	Ruijie Switch Device	Telnet View Modify

2. Choose "Ruijie Wireless Device", and click "Modify"

RG-SMP Security Management Platform - Internet Explorer

Authentication & Authority > Device > NAS Configuration Templates > Query

Template Name:

Totally 9 Records | Each Page 20 Records | Page 1 / totally 1 Pages | GO

All None	Template Name	SNMP v2c community	Operation
<input type="checkbox"/>	VPN Device	public	View Modify
<input type="checkbox"/>	Standard Radius Device	public	View Modify
<input type="checkbox"/>	Ruijie Wireless Device	ruijie	View Modify
<input type="checkbox"/>	Ruijie Wired Device	ruijie	View Modify
<input type="checkbox"/>	Ruijie Switch Device	ruijie	View Modify
<input type="checkbox"/>	RG-ePortal	ruijie	View Modify
<input type="checkbox"/>	RG-EG Device	public	View Modify
<input type="checkbox"/>	RG-ACE Device	public	View Modify
<input type="checkbox"/>	Non-Ruijie Wired Device	public	View Modify

Totally 9 Records | Each Page 20 Records | Page 1 / totally 1 Pages | GO

3. Configure "Identify Authentication Key" and "SNMP v2c Community"

RG-SMP Security Management Platform - Internet Explorer

Authentication & Authority > Device > NAS Configuration Templates > Modify

Basic Information

* Template Name: * Type:

Identify Authentication Configuration

* Identify Authentication Key:

Tips: The system and devices perform user authentication via the Radius Protocol. Identify authentication key is used for the encryption of data packets and should be the same as that of the devices.

Web Authentication Configuration

Web authentication Key:

Tips: After the Web authentication key is specified, the system will support Web authentication.

SNMP Configuration

* SNMP v2c Community:

Tips: The SNMP configuration should be the same as that on the devices. Otherwise the system cannot manage the devices.

Security Management

Device based NAC: Supported Unsupported

Tips:
You can set a template for the devices sharing the same SNMP version, authentication and Telnet parameters.

4. Add new device, fill in the IP address of the AC, and select "Ruijie Wireless Device" as configuration Templates

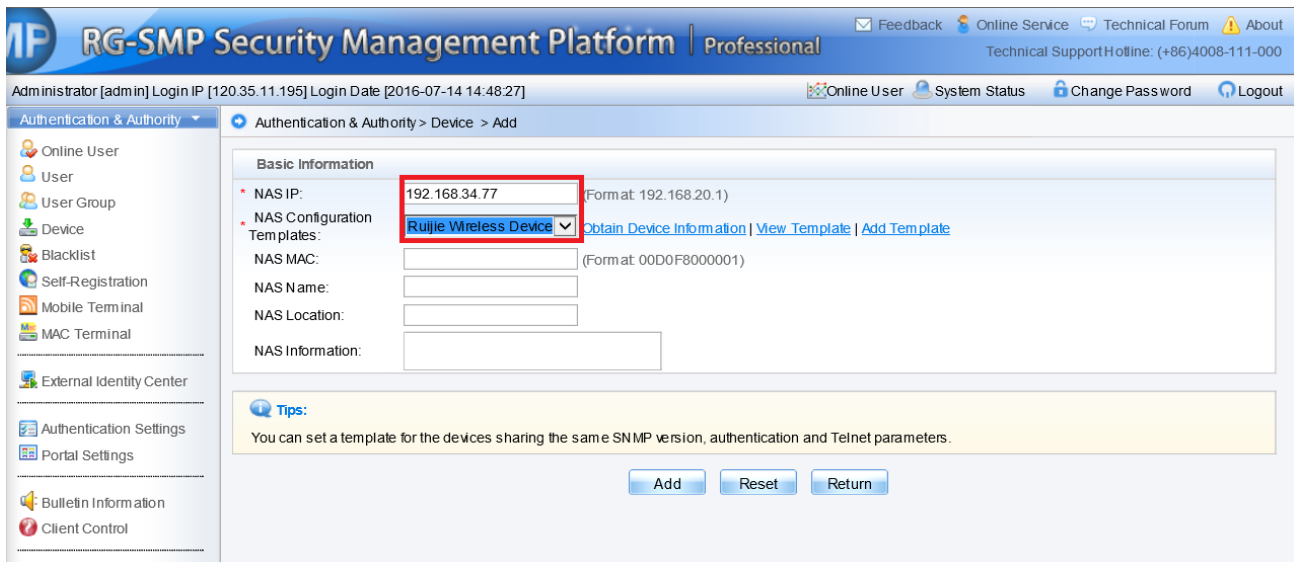

5. Add a new USER

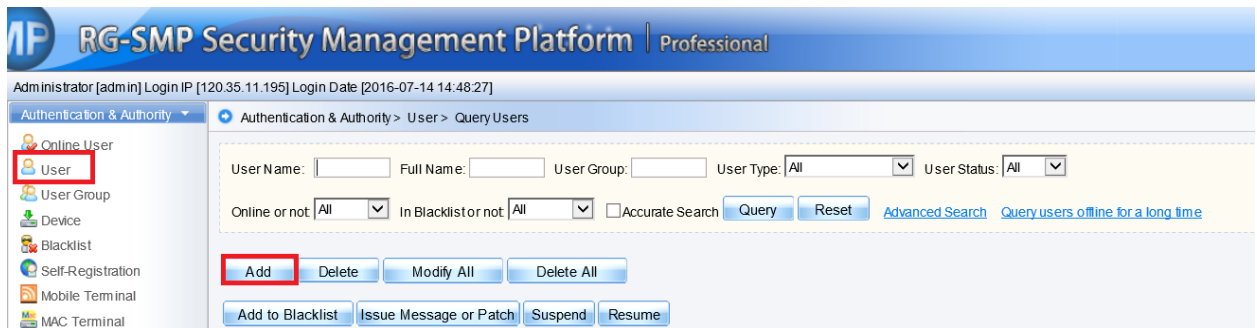

SAM

- 1) Login to SAM+ server --->"System" --->"Device Management"

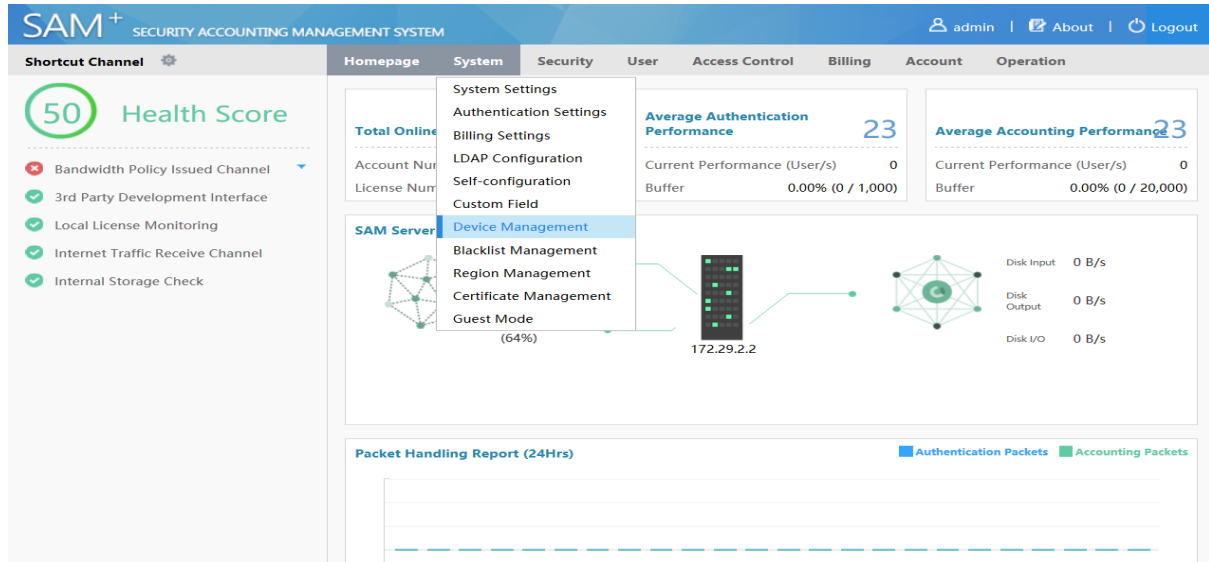

2) Select "Add"

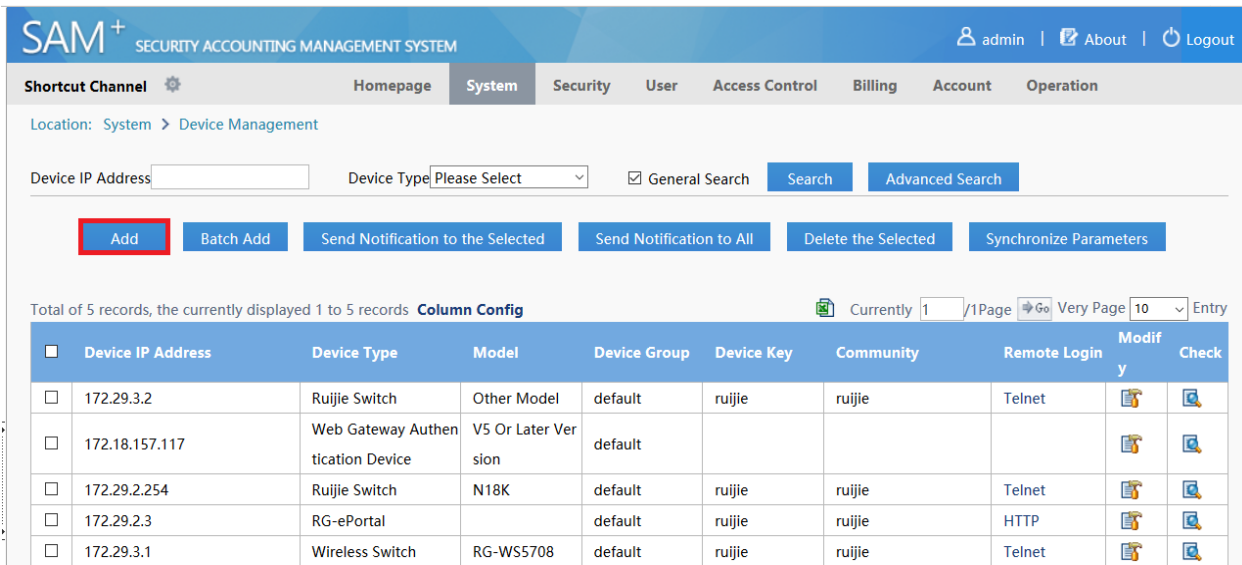

3) Add device, fill in the related parameters "Device IP Address" "IP Type" "Device Type" "Model" "Device Key" "Community" and click "Save"

Location: System > Device Management > Add

Device

Device IP Address* IP Type*

Device Type* Model*

PPPoE Authentication Please use comma or space to IPOE+Web Please use comma or space to

Domain [separate multiple domains](#) Authentication Domain [separate multiple domains](#)

Device Key* Community*

MAC Address* For trusted ARP binding SNMP Proxy Port If you do not fill in, the default

application, MAC address must be filled port 161 will be adopted

DHCP Login Username DHCP Login Password

Telnet Login Username Telnet Login Password

IV. Verification

1. Authenticate with built-in client of Windows. (See attached)
2. "Show dot1x summary" command shows online users

```
AC#show dot1x summary
      ID      MAC Address      Username      Interface VLAN      Authen-State      Backend-State
User-Type Online-Duration
-----
      3      9c4e.36cc.f6dc      lzm          Ca1              10      Authenticated      Idle
static  0days 0h 0m27s

3. "show wclient security" command shows users' authentication type
      AC#show wclient security 9c4e.36cc.f6dc
Security policy finished      :TRUE
Security policy type          :WPA-802.1X
WPA version                   :WPA2 (RSN)
Security cipher mode          :CCMP
Security EAP type             :PEAP
Security NAC status           :CLOSE
```

3. Users are able to access the Internet

5.8.2 MAC Authentication Bypass (MAB)

5.8.2.1 Configuring MAB on Wireless Device

I. Network Topology

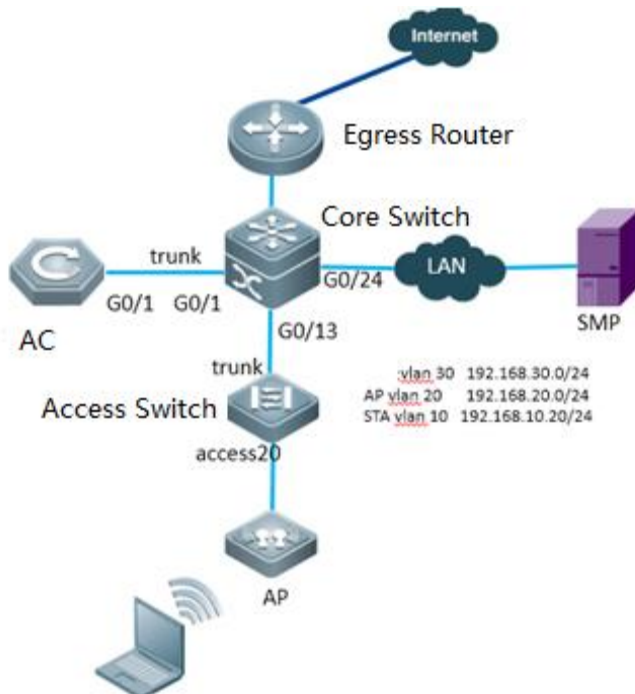

II. Configuration Steps

1. Enable MAB AAA authentication

```
Ruijie(config)#aaa new-mode ---->enable AAA authentication
```

```
Ruijie(config)#aaa group server radius MAB ---->define MAB radius server list
```

```
Ruijie(config-gs-radius)# server 192.168.34.183
```

```
Ruijie(config)#aaa accounting network dot1x-mab start-stop group MAB ---->define the default group of accounting
```

```
Ruijie(config)#aaa authentication dot1x dot1x-mab group MAB ---->define the default group of authentication
```

2. Configure Radius server

```
Ruijie(config)#radius-server host 192.168.34.183 key ruijie ----> configure ip address and key of radius server
```

3. Enable MAB on WLAN

```
Ruijie(config)#wlansec 1 ----> enable authentication on wlan 1
```

```
Ruijie(config-wlansec)# dot1x-mab
Ruijie(config-wlansec)# dot1x accounting dot1x-mab
Ruijie(config-wlansec)# dot1x authentication dot1x-mab
```

4. Configure SNMP server

```
Ruijie(config)#snmp-server enable traps
Ruijie(config)#snmp-server community ruijie rw
```

5.8.2.2 Configuring SMP Server

1) Login to SMP server ---> "Authentication & Authority" ---> "Device" ---> "NAS Configuration Templates"

2) Choose "Ruijie Wireless Device", and click "Modify"

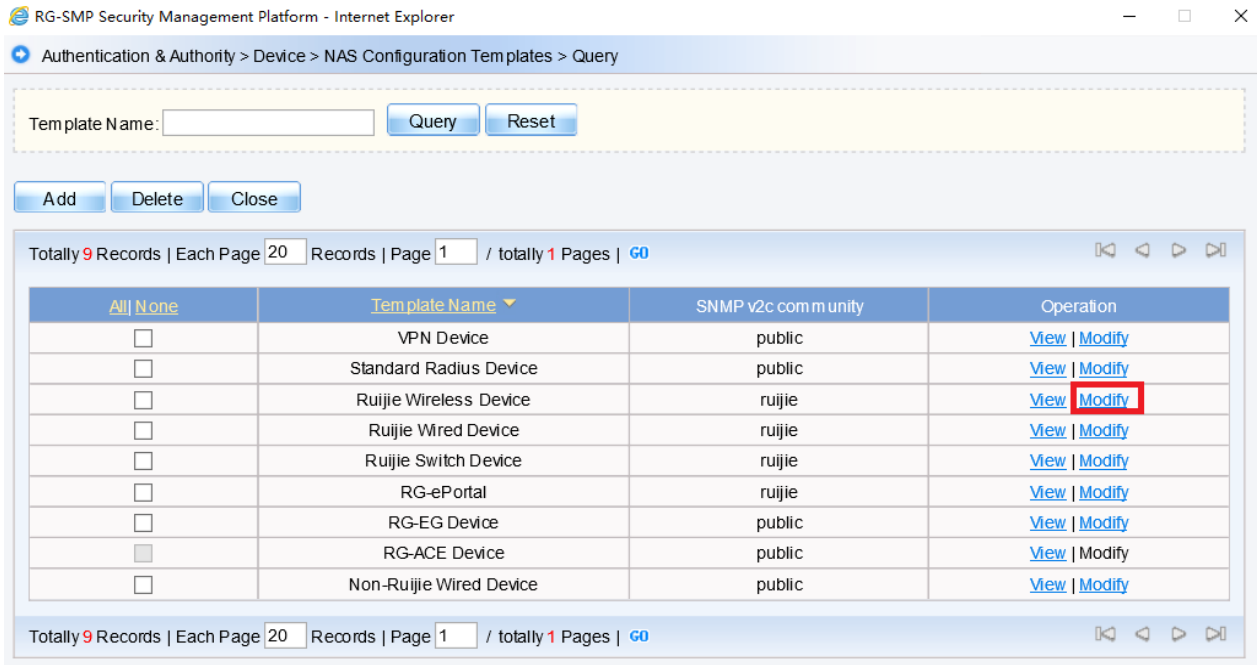

3) Configure "Identify Authentication Key" and "SNMP v2c Community"

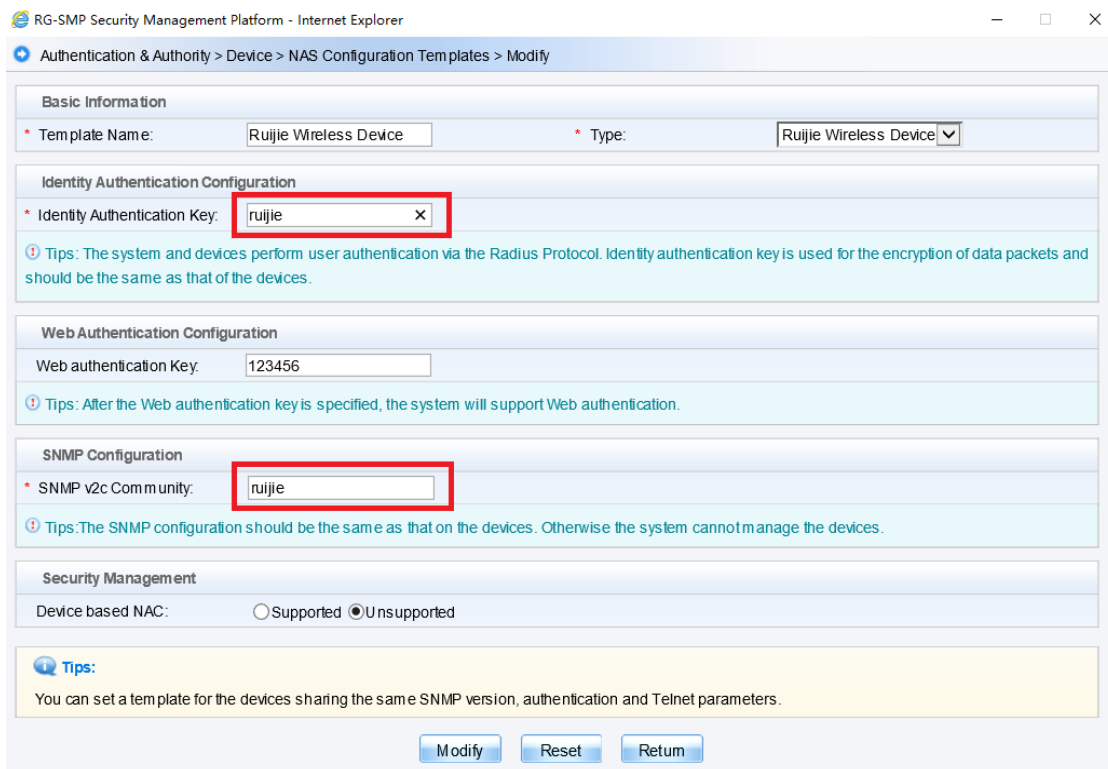

4) Add new device, fill in the IP address of the AC, and select "Ruijie Wireless Device" as configuration Templates

RG-SMP Security Management Platform | Professional

Administrator [admin] Login IP [120.35.11.195] Login Date [2016-07-14 14:48:27]

Authentication & Authority > Device > Add

Basic Information

- NAS IP: (Format: 192.168.20.1)
- NAS Configuration: **Ruijie Wireless Device** (Obtain Device Information | View Template | Add Template)
- NAS MAC: (Format: 00D0F8000001)
- NAS Name:
- NAS Location:
- NAS Information:

Tips:
You can set a template for the devices sharing the same SNMP version, authentication and Telnet parameters.

5) Add the MAC address of user's device

RG-SMP Security Management Platform | Professional

Administrator [admin] Login IP [120.35.11.195] Login Date [2016-07-14 14:48:27]

Authentication & Authority > MAC Terminal > Query MAC Terminal

Terminal MAC : NAS IP :

Connection Status : Blacklisted or not:

[MAC Terminal Configuration](#)

Totally 1 Records | Each Page 20 Records | Page 1 / totally 1 Pages | [GO](#)

<input type="checkbox"/>	Terminal MAC	NAS IP	NAS Port	VLAN	Connection Status	Blacklisted or not	Terminal Description	Operation
<input type="checkbox"/>	305A3AEA775D	172.29.3.2	3		Disconnected	No	my test	View Modify

Totally 1 Records | Each Page 20 Records | Page 1 / totally 1 Pages | [GO](#)

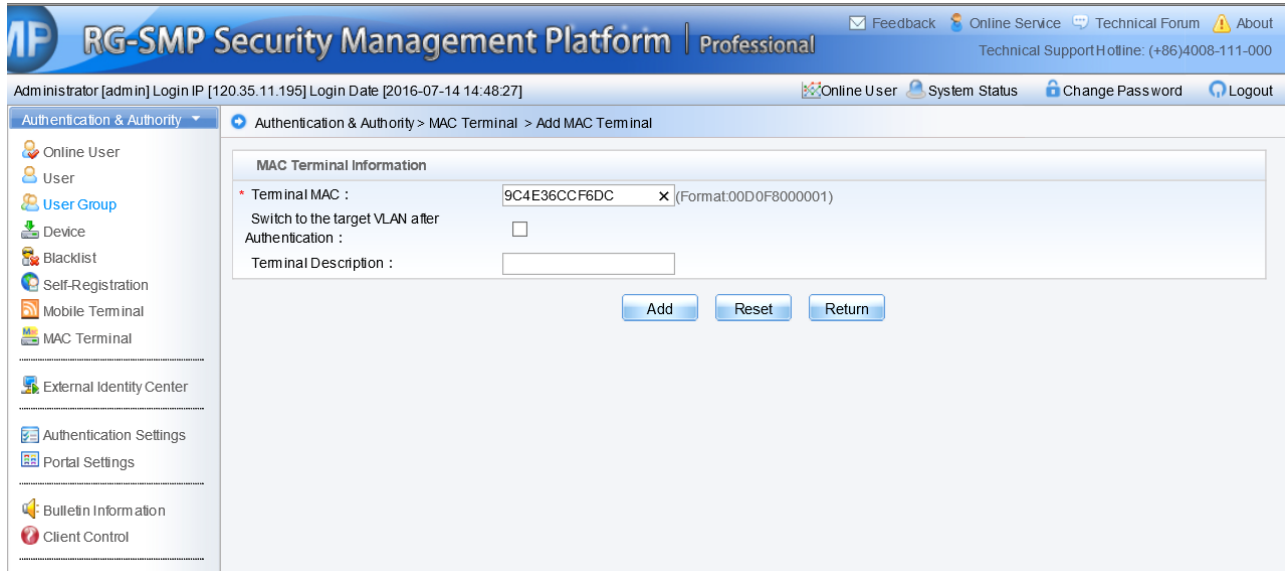

5.8.2.3 Configuring SAM+ Server

1) Login to SAM+ server --->"System" --->"Device Management"

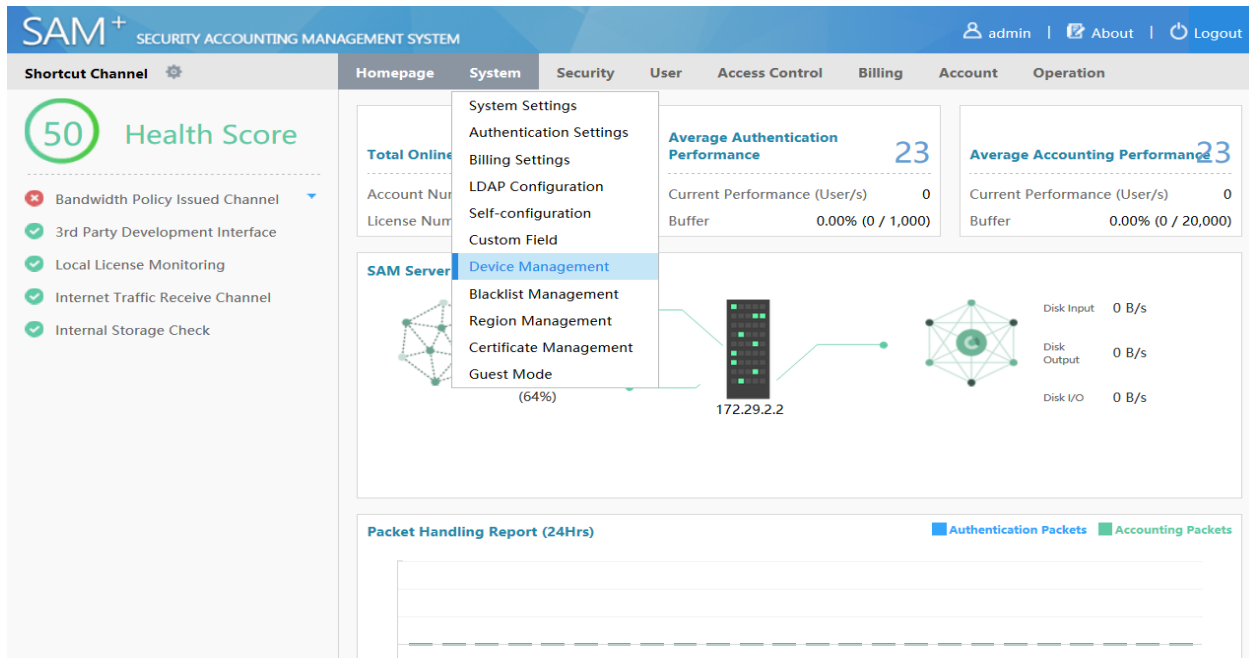

2) Select "Add"

The screenshot shows the SAM+ interface with the 'System' menu selected. The 'Device Management' section is active, displaying a table of devices. The table has columns for Device IP Address, Device Type, Model, Device Group, Device Key, Community, Remote Login, and Modif y. Five records are listed, with the first record having IP 172.29.3.2 and Device Type 'Ruijie Switch'.

<input type="checkbox"/>	Device IP Address	Device Type	Model	Device Group	Device Key	Community	Remote Login	Modif y	Check
<input type="checkbox"/>	172.29.3.2	Ruijie Switch	Other Model	default	rujie	rujie	Telnet		
<input type="checkbox"/>	172.18.157.117	Web Gateway Authentication Device	V5 Or Later Version	default					
<input type="checkbox"/>	172.29.2.254	Ruijie Switch	N18K	default	rujie	rujie	Telnet		
<input type="checkbox"/>	172.29.2.3	RG-ePortal		default	rujie	rujie	HTTP		
<input type="checkbox"/>	172.29.3.1	Wireless Switch	RG-WS5708	default	rujie	rujie	Telnet		

3) Add device, fill in the related parameters "Device IP Address" "IP Type" "Device Type" "Model" "Device Key" "Community" and click "Save"

The screenshot shows the 'Add Device' form in SAM+. Several fields are highlighted with red boxes: 'Device IP Address*' (192.168.33.38), 'Device Type*' (Wireless Switch), 'IP Type*' (IPv4), 'Model*' (RG-WS5708), 'Device Key*' (rujie), and 'Community*' (rujie). Other fields include PPPoE Authentication, Domain, MAC Address*, DHCP Login Username, and Telnet Login Username.

4) Create a new account and set the device's mac address a username&password

PS: For some versions of SAM+, you may also need to unselect "Prohibit the use of crack Ruijie client" and "Prohibit the Use of Non Ruijie Client" in Access Control.

SAM+ SECURITY ACCOUNTING MANAGEMENT SYSTEM admin | About | Logout

Shortcut Channel **Access Control** | Homepage | System | Security | User | **Access Control** | Billing | Account | Operation

Location: Access Control > Access Control > Modify

Access Control Information | User Information Check | Network Usage Control | Public Service | **User Behavior Control** | VPN Control

Client Version Management | Wireless Access Properties

Disable Modem Dial The modem dial-up users to blacklist

Prohibit the use of crack Ruijie client [Configuring Client Anti-crack](#) Prohibit users from modifying the physical MAC address

Prohibit Proxy Agent [Anti-proxy blacklist settings](#)

Client Heartbeat Settings

not enabled client heartbeat

Normal Heartbeat (heartbeat detection is enabled only compatible with cable, wireless access device authentication user, using normal heartbeat protocol)

V3 anti-crack heartbeat (anti-cracking algorithm combines the V3 heartbeat, for Ruijie wired and wireless access equipment, cable compatible devices authenticated users do heartbeat)

Client re-authentication interval (0 to 600 minutes) 0 means no re-launched certification

SAM+ SECURITY ACCOUNTING MANAGEMENT SYSTEM admin | About | Logout

Shortcut Channel **Access Control** | Homepage | System | Security | User | **Access Control** | Billing | Account | Operation

Location: Access Control > Access Control > Modify

Access Control Information | User Information Check | Network Usage Control | Public Service | User Behavior Control | VPN Control

Client Version Management | Wireless Access Properties

Prohibit the Use of Non Ruijie Client

Allow to Use SuForGSN Open Lowest Version Limit Minimum Allowed Version

Enable Automatic Upgrades The Latest Upgraded Version

URL Upgrade Address * URL upgrade mode targets version 3.0 or above

Allow to Use SuA Open Lowest Version Limit Minimum Allowed Version

Enable Automatic Upgrades The Latest Upgraded Version

URL Upgrade Address * URL upgrade mode targets version 3.0 or above

Allow to Use SuForMac Enable Automatic Upgrades The Latest Upgraded Version

URL Upgrade Address

Allow to Use LinuxSu Open Lowest Version Limit Minimum Allowed Version

Enable Automatic Upgrades The Latest Upgraded Version

URL Upgrade Address

5.8.2.4 Verification

1. Connect SSID with two different STA: one is registered on AAA server, the other one is not. The registered STA is able to access the Internet, while the other one is not.
2. Check the online users on AAA server.
3. Show wireless users status on AC using command "show ac-config client"

```
AC#show ac-config client
```

```

===== show sta status =====
AP   : ap name/radio id
Status: Speed/Power Save/Work Mode, E = enable power save, D = disable power save

Total Sta Num: 1

STA MAC      IPV4 Address  AP              Wlan
Vlan Status  Asso Auth Net Auth  Up time
-----
9c4e.36cc.f6dc 192.168.51.84  1414.4b65.3cf0/1  1  10  144.4M/D/bn
MAB           0:00:01:47

```

5.9 Web Authentication

5.9.1 Understanding Web Authentication

Overview

Web authentication is a authentication method for controlling users' network access. This authentication method does not require users to install special client authentication software, and the authentication is supported by general browsers.

When an unauthenticated user accesses the network using a browser, the network access device directs the browser to a specific site, namely the Web authentication server, which is called the Portal Server, and the user can access part of services without authentication, such as downloading security patches and reading announcements. If the user desires to access other network resources beyond the authentication server, he/she must pass authentication at the Portal server via the browser. Only authenticated users can get access to the Internet.

Besides the convenience in the authentication, since the portal server and the user browser have page interactions which can be used for personalizing service such as posting advertise ments, notices and business interlinks on the portal server page, therefore, it has a promising prospect.

HTTP Interception and **HTTP Redirection** are two important components in Web Authentication

HTTP Interception

HTTP interception means the access device blocks HTTP packets which are intended to be forwarded. Such HTTP packets are sent by users' browsers that are connected to access devices but not destined to these devices. For example, a user uses IE to access www.google.com, the access device is expected to forward its HTTP request packets to the gateway. However, if HTTP interception is enabled, these packets will not be forwarded.

After the HTTP interception, the access device directs the HTTP connection requests from the user to itself and thus establishes a session between the access device and the user. The access device uses the HTTP redirection function to

push the redirection page to the user, and the user's browser will show a window which may require authentication, or may display a link for downloading software.

With Web authentication function, it is possible to set which users' HTTP packets to the destination ports are to be blocked, and which are not to be blocked. Generally, HTTP requests from unauthenticated users are intercepted, and those from authenticated users are not intercepted. HTTP interception is the foundation of Web authentication. The Web authentication process is automatically triggered once HTTP interception takes place.

HTTP Redirection

According to the HTTP protocol, generally, after a user's browser sends HTTP GET or HEAD request packets, the receiver responds with a 200 message if it is able to provide the required resources, or the receiver responds with a 302 message if it is unable to do so. A new site path is provided in the 302 message. After the user has received the response, it may re-send the HTTP GET or HEAD request packets to the new site for requesting resources, which is called redirection.

HTTP redirection is an important part of Web authentication and takes place after HTTP interception. It uses the special characteristic of the 302 message in the HTTP protocol. HTTP interception leads to the creation of a session between the access device and the user. After that, the user sends the HTTP GET or HEAD request packets (which should have been sent to another site) to the access device, which then responds with a 302 message and specifies the site path of the redirection page in the 302 message. In this way, the user re-sends the requests along to the new site path and gets the redirection page.

Attentions:

In Ruijie System, there're two kinds of WEB Authentications: **Ruijie Web Authentication V2** and **Built-in Web Authentication**. Usually, we implement in below ways:

In **Ruijie Web Authentication V2**,

1. The portal is an additional single server, like Ruijie SMP (Secure Management Platform).
2. The user identities & password are stored in Radius Server, like Ruijie SMP (Secure Management Platform).
3. It is more powerful, flexible and complicated than **Built-in Web Authentication**.

In **Built-in Web Authentication**,

1. The portal is built in AC, no additional portal server is required
2. The user identities&password are stored in AC local database, OR in Radius Server, like Ruijie SMP (Secure Management Platform).
3. The performance, user throughput and authentication methods are not as strong as **Ruijie Web Authentication V2**.

Ruijie Web Authentication V2

Components

Components in a complete Web authentication work flow: End user, access device, Portal Server, Radius Server

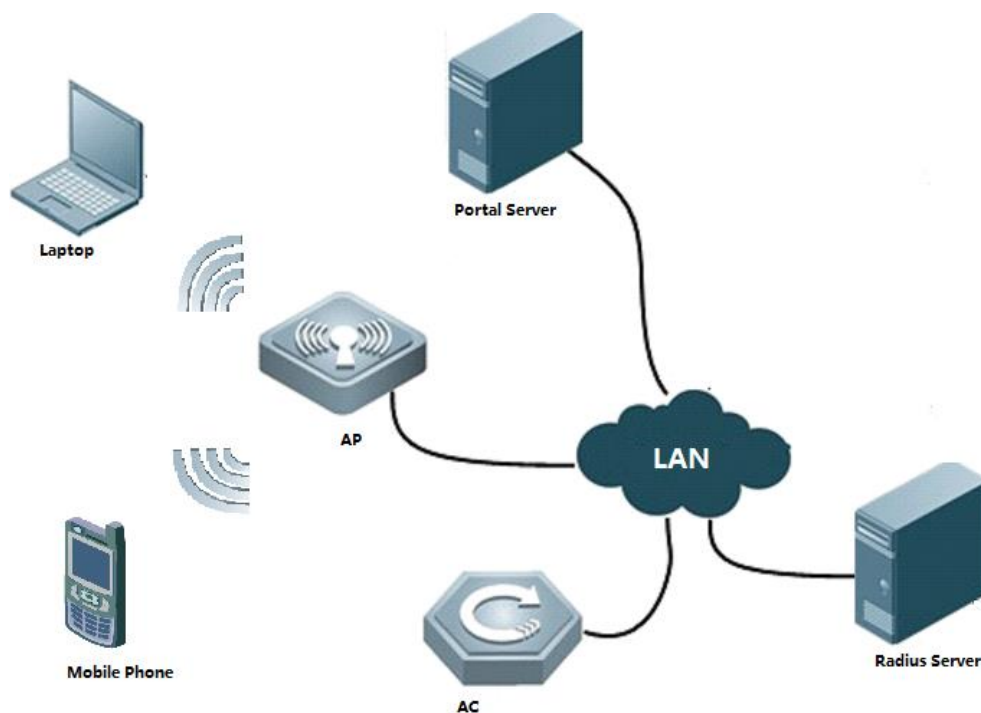

1.End user(STA): A computer, a mobile phone or a pad which runs HTTP protocol and with which users visit Internet.

2.Access device(AC&AP): Generally refers to an access layer device (for example, a wireless AP in a WLAN) in the network topology. It is generally directly connected to the user's terminal device, and web authentication must be enabled on the access device. The access device receives the authentication information of the user from the Portal server, and sends an authentication request to the RADIUS server. The access device determines whether the user can access the Internet based on the authentication results and replies the results to the Portal server.

3.Portal Server: For example, Ruijie SMP (Secure Management Platform), it provides authentication page and related operation for web authentication. When the Portal server receives HTTP-based authentication requests sent by the authentication client, it collects account information and sends it to the access device, and then replies the result to the user via the page according to the authentication results from the access device.

4.Radius Server: For example, Ruijie SMP (Secure Management Platform), it provides standard radius protocol-based remote authentication.

Authentication Work Flow

1. Before authentication, the access device blocks all HTTP requests sent by the unauthenticated user and redirects the requests to the Portal server. Then, an authentication window pops up in the user's browser.
2. During authentication, the user inputs the authentication information (username, password and verification code.) on the authentication page to interact with the Portal server.

3. The Portal server sends the authentication information of the user to the access device.
4. The access device initiates an authentication request to the RADIUS server and replies the result to the Portal server.
5. The Portal server responds to the user with a page to indicate the result (success or failure).

For details, see diagram below:

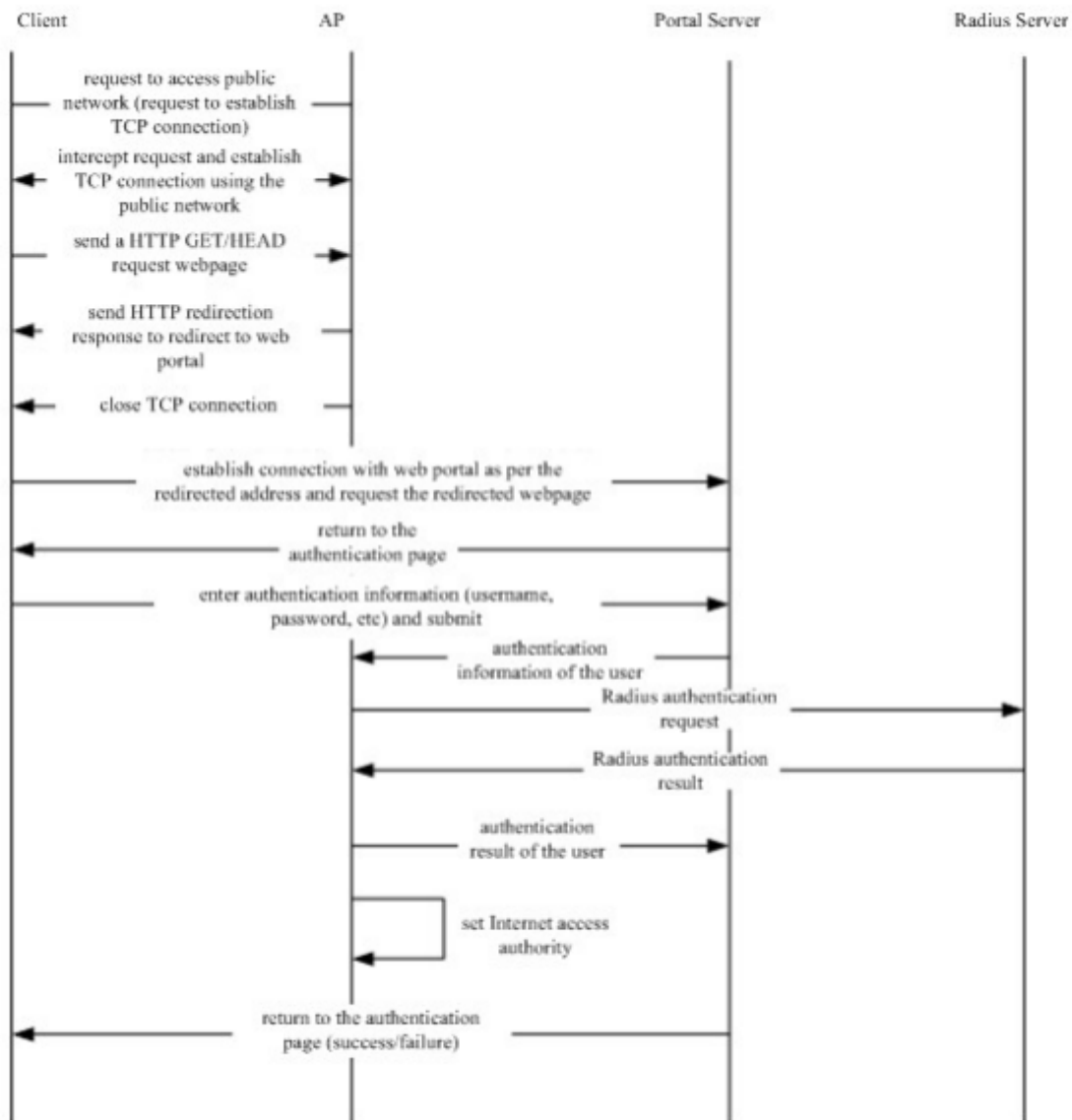

User Logout

There are two types of user logout:

One is the user logout detected by the access device because user's time is out, the traffic data is used up or the link is interrupted.

The other is that the user logout detected by the Portal Server because the user triggers the logout application through a logout page.

Scenario 1: The access device detects the user's logout and informs the Portal Server, and then the Portal Server deletes the user information (through portal protocol), and the Portal Server will then inform the user through a logout page.

Scenario 2: The Portal Server detects the user's logout and informs the access device (through portal protocol) and informs the user with a logout page.

In the above two scenarios, the Portal Server will send a stop-accounting request to the Radius Server and notify the Radius Server that the user has logged out.

Built-in Web Portal

Components

Components in a complete Web authentication work flow: End user, access device, Portal Server, Radius Server

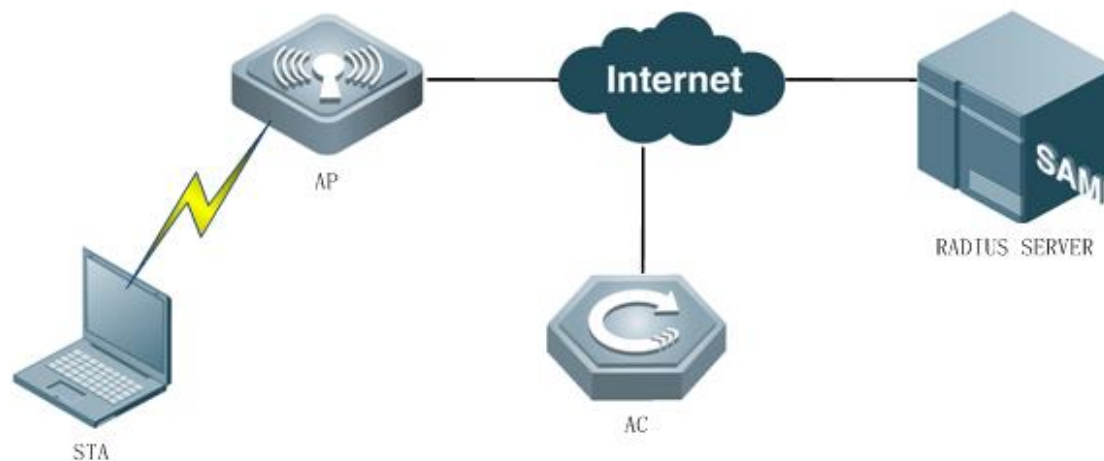

1. End user: A computer, a mobile phone or a pad which runs HTTP protocol and with which users visit Internet.

2. Access device (AC&AP): Generally refers to an access layer device (for example, a wireless AP in a WLAN) in the network topology. It is generally directly connected to the user's terminal device, and web authentication must be enabled on the access device. The access device receives the authentication information of the user from the Portal server, and sends an authentication request to the RADIUS server. The access device determines whether the user can access resources of the Internet based on the authentication results and replies the results to the Portal server.

3. Radius Server: For example, Ruijie SMP (Secure Management Platform), it provides standard radius protocol-based authentication of remote users.

Authentication Work Flow

1. Before authentication, the access device will intercept all HTTP requests sent by unauthenticated users and redirect such requests to the Portal authentication page, then an authentication page will pop up on user's browser.
2. During authentication, the user will type in the authentication information (username, password, validation code, etc) on the authentication page to interact with the built-in portal module of device.
3. The built-in portal module will then submit user's authentication information to the authentication module of access device.
4. The authentication module accepts user's authentication request, indirectly initiates an authentication request to the Radius Server and forwards the authentication result to the Portal Server.
5. The built-in portal module will respond to the user with a webpage indicating the authentication result (login page/success or failure information).

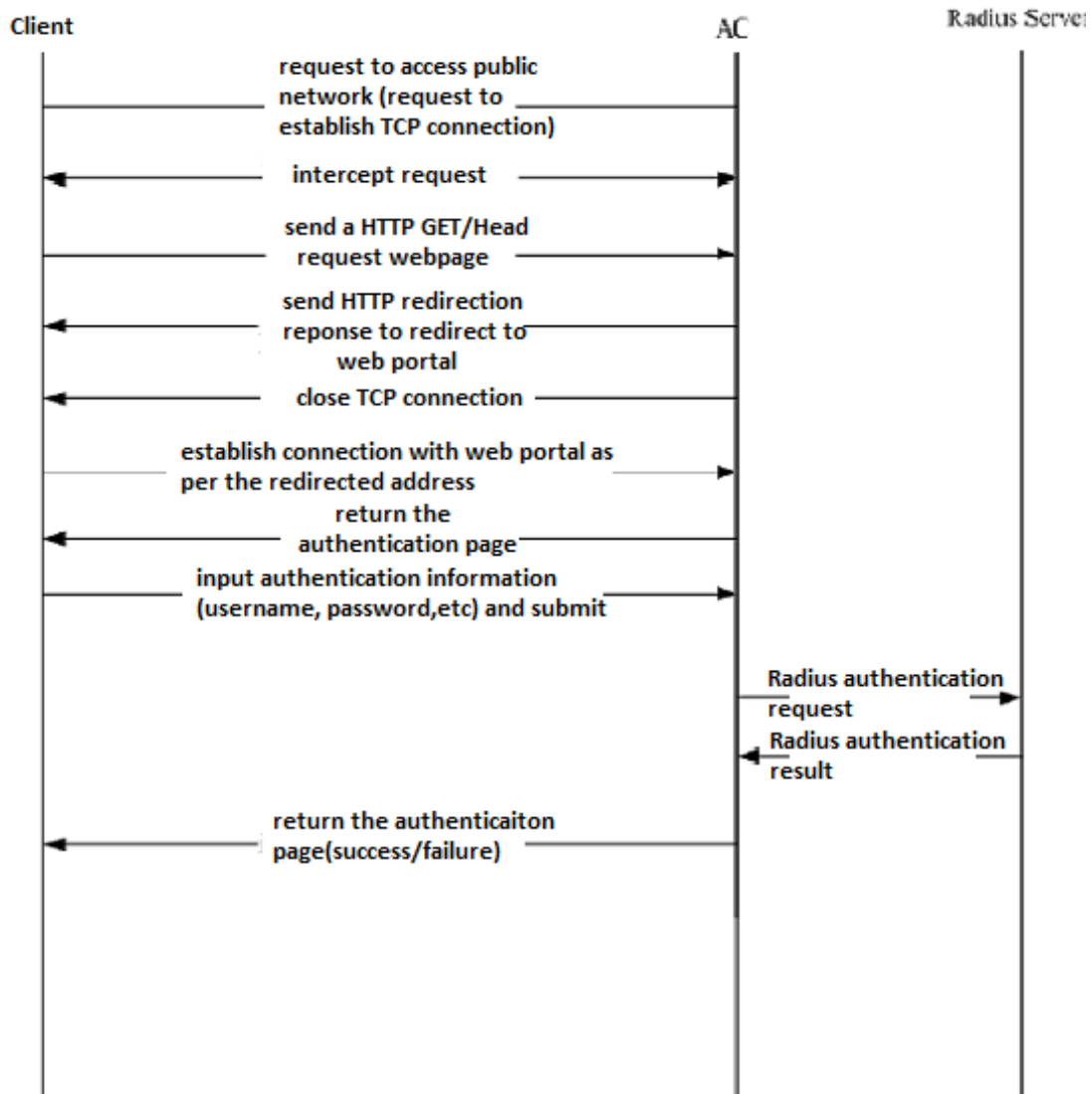

User Logout

The access device detects the user's logout through the information on the logout page of the built-in Portal Server, or the link is lost or no online hours or traffic is available.

The access device sends a stop-accounting request to the Radius Server and logs out the user.

The built-in Portal Server responds to the user with a successful logout page.

5.9.2 Built-in Web Portal & Local Authentication

I. Requirements

1. Finish [Common Features --> FIT AP Basic configuration](#)

II. Network Topology

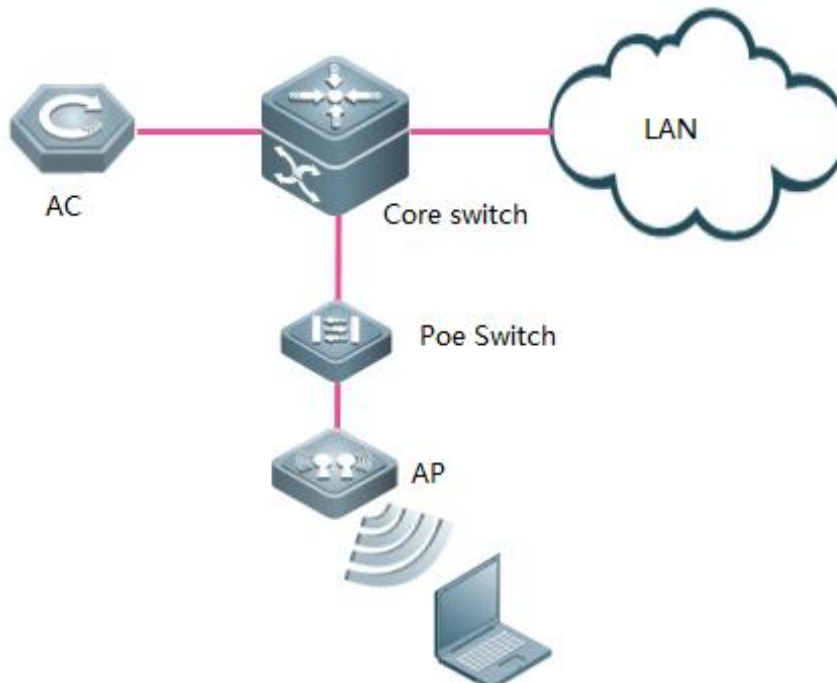

III. Configuration Steps

1. Configuring AAA

```
AC#config terminal
AC(config)#aaa new-model ----->enable AAA authentication
AC(config)#aaa accounting network default start-stop none ----->disable aaa accounting
AC(config)#aaa authentication ipportal default local -----> authenticate with local accounts
```

2. Configuring local accounts

```
AC(config)#username admin web-auth password admin ----->configure local username and password
```

3. Bypass arp packets of wireless user gateway

```
AC(config)#http redirect direct-arp 192.168.51.1 ----->192.168.51.1 is wireless users' gateway
```

4. Enable https

```
AC(config)#http redirect port 443
```

5. Configuring Wlansec

```
AC(config)#web-auth template iportal ----->need to add this command
AC(config)#wlansec 1 ----> enable authentication on wlan 1
AC(config-wlansec)#web-auth portal iportal
AC(config-wlansec)#webauth
AC(config-wlansec)#end
```

6. Saving configuration

```
AC#write
```

IV. Verification

1. Connect to wireless ssid, authentication page pops up, input useranme / password, pass the authentication, and start visiting Internet.



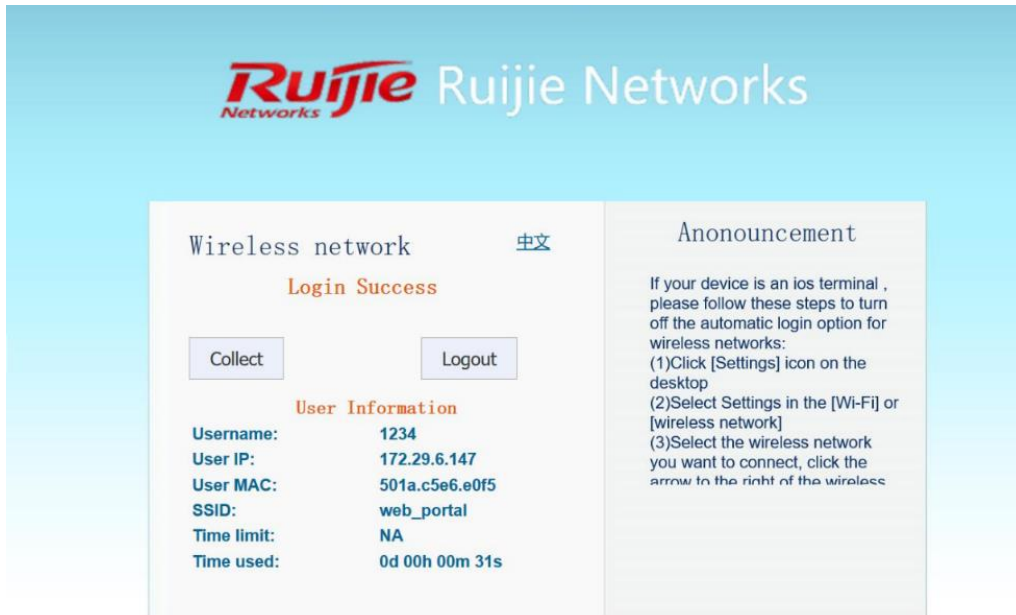

© 2012 Ruijie Networks Co., Ltd.

- Execute command "show web-auth user all" on AC to display authenticated online users.

```

AC#show web-auth user all
Statistics:
Type           Online  Total  Accumulation
-----
v1 portal      0       0       1
v2 Portal      0       0      11
Intra Portal   1       1       2
-----
Total          1       1      14

V1 Portal Authentication Users
Index          Address                               Online Time Limit  Time used  Status
-----
-----

Intra Portal Authentication Users
Index          Address                               Online Time Limit  Time used  Status
-----
1             192.168.51.29                        On             0d 00:00:00  0d 00:00:00  Active
    
```

V2 Portal Authentication Users

Index	Address	Online Time Limit	Time used	Status

5.9.3 Built-in Web Portal & Radius Authentication

I. Network Topology

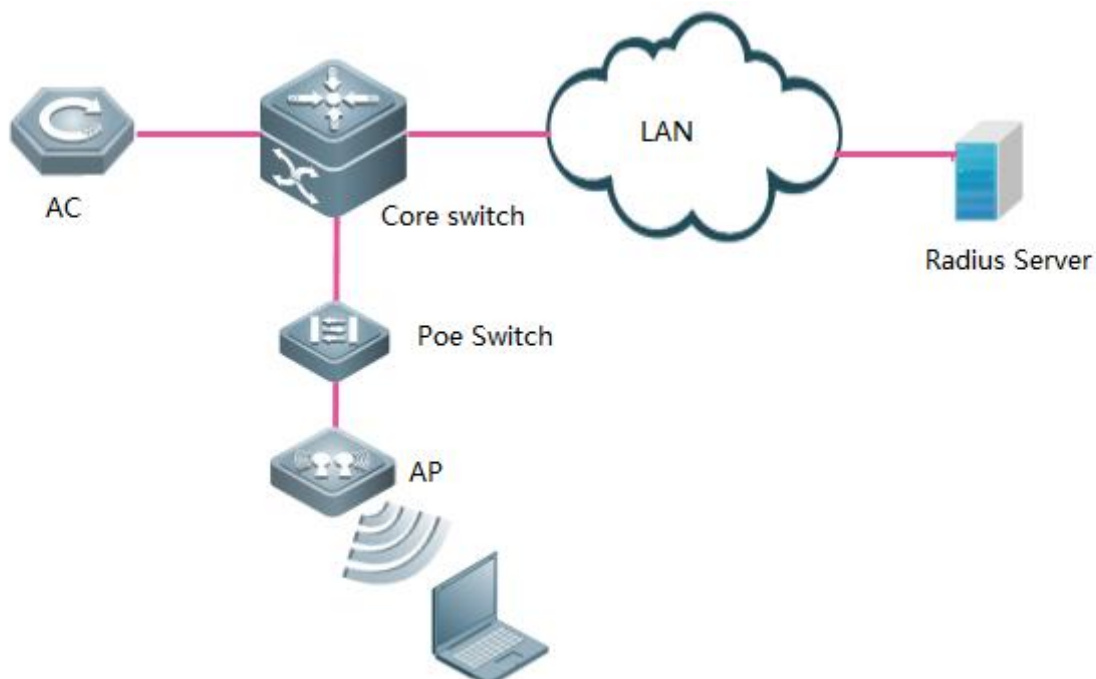

II. Configuration Steps

1. Configuring AAA

```
AC#config terminal
```

```
AC(config)#aaa new-model ---->enable AAA authentication
```

```
AC(config)#aaa accounting network default start-stop group radius ---->define the default group of accounting
```

```
AC(config)#aaa authentication iportal default group radius ---->define the default group of web authentication
```

2. Configuring Radius Server Parameters

```
AC(config)#radius-server host 192.168.51.103 key ruijie ---->configure the IP address and key of radius server
AC(config)#ip radius source-interface vlan 1
AC(config)#radius-server attribute 31 mac format ietf
```

3. Bypass arp packets of wireless user gateway

```
AC(config)#http redirect direct-arp 192.168.51.1 ----->gateway of wireless users
```

4. Enable redirect port

```
AC(config)#http redirect port 8081
```

5. Configuring Wlansec

```
AC(config)#web-auth template iportal -----> need to add this command
AC(config.tmplt.iportal)#exit
AC(config)#wlansec 1 ----> enable authentication on wlan 1
AC(config-wlansec)#web-auth portal iportal
AC(config-wlansec)#webauth
AC(config-wlansec)#exit
```

6. Configuring SNMP

```
AC(config)#snmp-server community ruijie rw
```

7. Configuring username&password saving Configuration

```
AC(config)#username admin password admin ----->configure username and password for user login
AC(config)#end
AC#write
```

8. Configuring Radius Server

Suggest install standard Radius Server, like Ruijie SMP (Security Management Platform)

For detail, visit Ruijie official website at <http://www.ruijienetworks.com>, Category "Software"

You may also install other 3rd party Radius Server.

III. Verification

1. Connect to wireless ssid, authentication page pops up, input useranme / password, pass the authentication, start visiting Internet.



2. Execute command "show web-auth user all" on AC to display authenticated online users.

```

AC#show web-auth user all

Statistics:
Type           Online  Total  Accumulation
-----
v1 portal      0       0       1
v2 Portal      0       0      11
Intra Portal   1       1       1
-----
Total          1       1      13

V1 Portal Authentication Users
Index          Address                               Online Time Limit  Time used  Status
-----
-----

Intra Portal Authentication Users
Index          Address                               Online Time Limit  Time used  Status
-----
1      192.168.51.29                               On    240d 00:00:00 0d 00:00:00  Active
-----

V2 Portal Authentication Users
Index          Address                               Online Time Limit  Time used  Status
-----
-----
    
```

5.9.4 Ruijie Web Authentication V2 & Radius Authentication

I. Network Topology

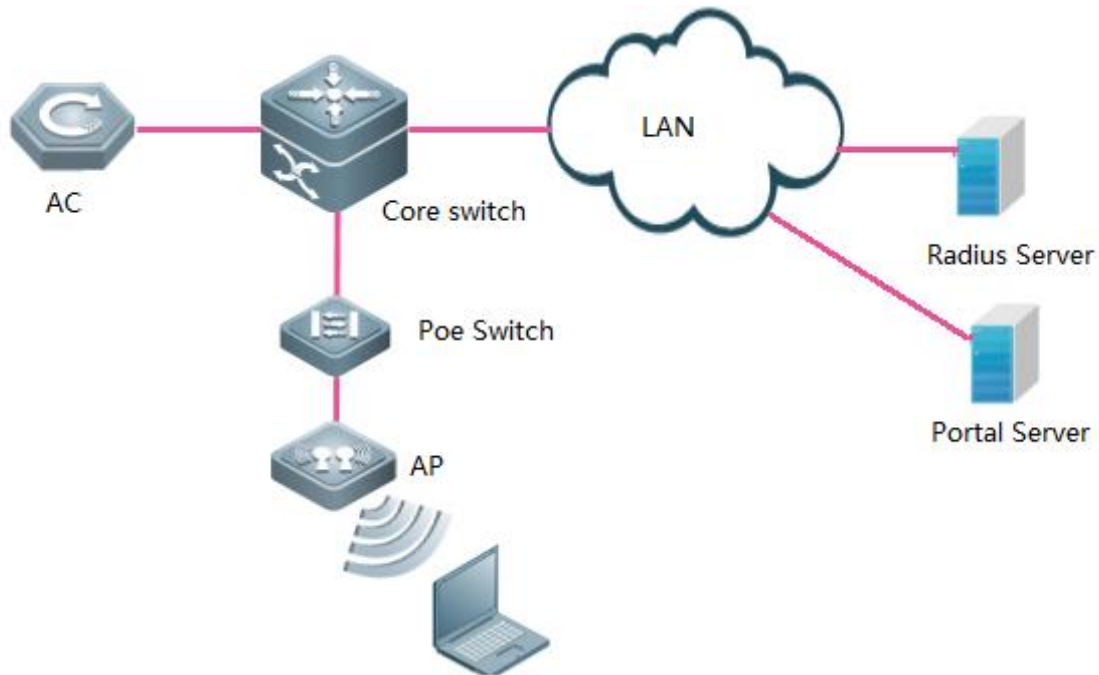

II. Configuration Steps

1. Configuring AAA

```

AC#config terminal
AC(config)#aaa new-model ----->enable AAA authentication
AC(config)#aaa accounting network default start-stop group radius ---->define the default group of accounting
AC(config)#aaa authentication web-auth default group radius ---->define the default group of web authentication
AC(config)#aaa accounting update ---->enable accounting
AC(config)#aaa accounting update periodic 15 ---->define update periodic
  
```

2. Configuring Radius Server Parameters

```

AC(config)#radius-server host 192.168.51.103 key ruijie ---->configure the IP address and key of radius server
AC(config)#ip radius source-interface bvi 1
AC(config)#radius-server attribute 31 mac format ietf
AC(config)#web-auth portal key 123456 ----->the key should match in Portal Server
  
```

2. Configuring portal-server. Wireless user will be redirected to this authentication page

【10.X configuration command】

```
AC(config)#portal-server eportalv2 ip 192.168.51.38 url http://192.168.51.38/eportal/index.jsp ----->this URL
is just a sample, it depends on portal-server you are configuring.
```

【11.X configuration command】

```
AC(config)#web-auth template eportalv2
AC(config.tmplt.eportalv2)#ip 192.168.51.38
AC(config.tmplt.eportalv2)#url http://192.168.51.38/eportal/index.jsp
AC(config.tmplt.eportalv2)#exit
```

4. Bypass arp packets of wireless user gateway

```
AC(config)#http redirect direct-arp 192.168.51.1 ----->gateway of wireless users
```

4. Configuring Wlansec

```
AC(config)#wlansec 1 ----> enable authentication on wlan 1
AC(config-wlansec)#webauth
AC(config-wlansec)#web-auth portal eportalv2
AC(config-wlansec)#exit
```

6. Configuring SNMP

```
AC(config)#snmp-server host 192.168.51.103 traps version 2c ruijie ----->192.168.51.103 is Radius Server IP
address. Here takes Ruijie SAM+ for example.
AC(config)#snmp-server host 192.168.51.38 traps version 2c ruijie ----->192.168.51.38 is Portal Server IP
address. Here takes Ruijie e-portal for example.
AC(config)#snmp-server enable traps web-auth
AC(config)#snmp-server community ruijie rw
```

7. Configuring username&password and saving configuration

```
AC(config)#username admin password admin
AC(config)#end
AC#write
```

6. Configuring Portal Server and Radius Server

Here takes Ruijie SAM+ as example. For detail, visit Ruijie official website at <http://www.ruijienetworks.com>, Category "Software"

You may also install other 3rd party Portal servers and Radius Server.

III. Verification

1. Connect to wireless ssid, authentication page pops up, input username / password, pass the authentication, start visiting Internet.

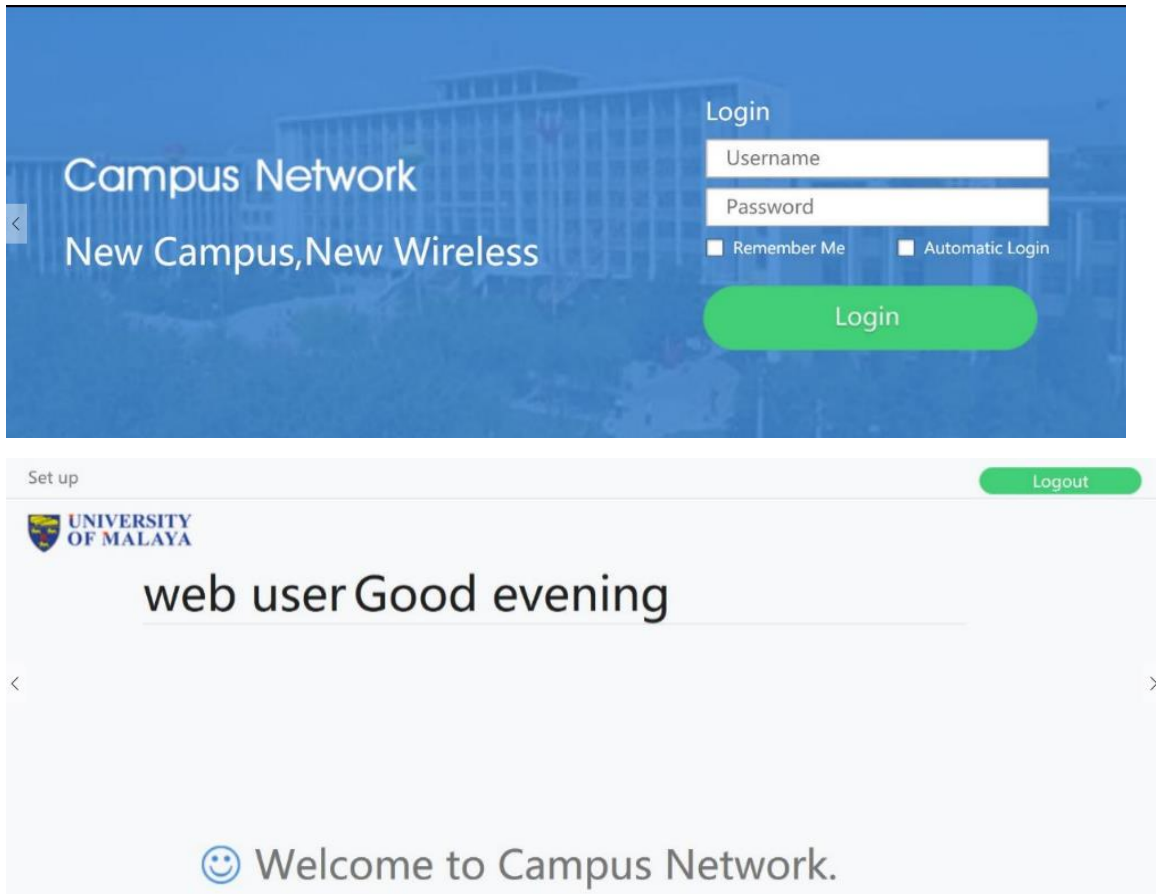

2. Execute command "show web-auth user all" on AC to display authenticated online users.

```
AC#show web-auth user all
Statistics:
Type           Online  Total  Accumulation
-----
v1 portal      0       0       1
v2 Portal      1       1      112
Intra Portal   0       0       0
-----
Total          1       1      12
V1 Portal Authentication Users
Index          Address                               Online Time Limit  Time used  Status
```

```
-----
-----
Intra Portal Authentication Users
Index          Address                               Online Time Limit   Time used   Status
-----
-----
V2 Portal Authentication Users
Index          Address                               Online Time Limit   Time used   Status
-----
-----
1             192.168.51.29                        On                 240d 00:00:00 0d 00:00:00   Authenticated
-----
-----
```

5.9.5 Ruijie Web Portal Customization

AC Built-in Portal Customization

Step 1, log on to wireless controller via CLI, execute command `dir` to display file/folder list

```
WS6108#dir
Directory of flash:/
Number  Properties   Size           Time                               Name
-----  -
1       drwx         160B           Sat Mar 21 14:50:16 2015   rep
2       drwx         224B           Thu Jan 1 00:00:07 1970   var
3       -rw-        100.8k         wed Nov 4 16:45:07 2015   tech_vsd0_20151104164506.tar.gz
4       -r--        139B           Thu Nov 5 21:05:56 2015   tmp_env.txt
5       -rwx         5.0k           Tue Jun 2 17:16:49 2015   hwd.db
6       drwx        232B           Sat Mar 21 14:50:41 2015   security
7       drwx         224B           Thu Jan 1 00:00:07 1970   vsd
8       drwx         160B           Thu Jan 1 00:00:07 1970   vsd_common
9       -rw-        5.1k           Tue Nov 24 10:10:06 2015   config.text
10      -rwx        21.3M         Mon Oct 12 16:11:54 2015   AP_RG0511.1(5)B5_S1N2-02_02192710_install.bin
11      drwx         160B           Thu Nov 5 21:05:33 2015   tmp
12      -rwx        696B           Sat Mar 21 14:50:34 2015   httpd_cert.crt
13      -rwx         21B           Tue Nov 24 10:10:06 2015   syslog_rfc5424_flag.txt
14      drwx         424B           Mon Jun 29 12:37:29 2015   portal
15      -rw-        16.6M         Fri Jul 3 10:27:53 2015   ap320-up.bin
16      -rw-         4B            Thu Jan 1 00:00:12 1970   reload
17      -rw-        76.5k         Thu Jun 11 15:11:21 2015   tech_vsd0_20150611151120.tar.gz
18      -rwx         7.5k         Fri Jun 19 11:22:25 2015   BeforeRIPT.text
19      drwx         224B           Tue Jun 2 17:13:53 2015   upgrade
20      drwx         376B           Thu Jun 25 18:13:56 2015   rg_licns
21      drwx         160B           Thu Jan 1 00:00:12 1970   syslog
22      drwx         160B           Tue Jun 2 17:16:40 2015   upgrade_rep
23      -rw-        212B         Tue Nov 24 10:10:06 2015   ap-config.text
24      -rw-        51.6k         Tue Jun 2 16:28:33 2015   tech_support_20150602162832.tar.gz
25      -rwx         887B         Sat Mar 21 14:50:34 2015   httpd_key.pem
14 files, 11 directories
281,903,104 bytes data total (241,856,512 bytes free)
536870912 bytes flash total (241,856,512 bytes free)
WS6108#
```

Step 2, enter folder `portal` by command `cd portal`, execute `dir` to display list

```

WS6108#cd portal
WS6108#
WS6108#dir
Directory of flash:/portal
Number  Properties  Size              Time              Name
-----  -
 1      drwx           376B             Tue Aug 18 23:09:47 2015  zip
 2      drwx           160B             Tue Jun  2 17:16:54 2015  logo
 3      drwx           288B             Tue Nov 24 10:10:06 2015  ext_zip
0 files, 3 directories
281,903,104 bytes data total (241,856,512 bytes free)
536870912 bytes flash total (241,856,512 bytes free)
WS6108#

```

Step 3, enter folder `zip`, `default.zip` is the http package for iportal (built-in portal)

```

WS6108#cd zip
WS6108#dir
Directory of flash:/portal/zip
Number  Properties  Size              Time              Name
-----  -
 1      -rwx         86.7k            Thu Nov  5 21:06:03 2015  gateway.zip
 2      -rwx         91.0k            Tue Aug 18 23:09:46 2015  custom.zip
 3      -rwx         91.0k            Thu Nov  5 21:06:02 2015  default.zip
3 files, 0 directories
281,903,104 bytes data total (241,856,512 bytes free)
536870912 bytes flash total (241,856,512 bytes free)
WS6108#

```

step 4, setup tftp server on your local laptop, transfer `default.zip` back. We will use it as http code template.

```

WS6108#copy default.zip tftp://172.29.7.1/default.zip
Press Ctrl+C to quit
!
Copy success.
WS6108#

```

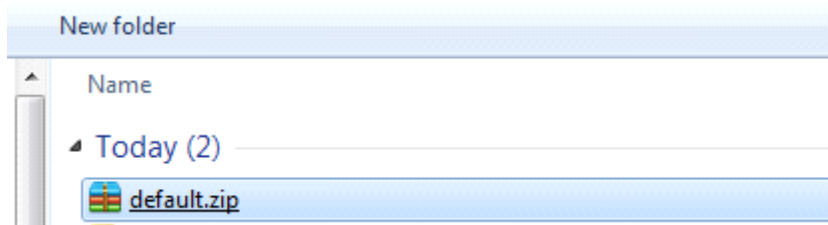

step 5, decompress this zip file, you will get a file list as shown below,

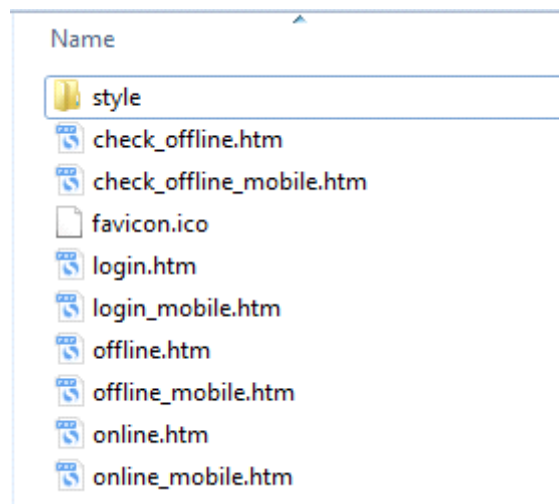
**Description:**

[login.htm](#) > PC login page

[login_mobile.htm](#) > mobile login page

[offline.htm](#) > PC offline page

[offline_mobile.htm](#) > mobile offline page

[online.htm](#) > PC online page

[online_mobile.htm](#) > mobile online page

Enter folder **Style**, you will get below file list.

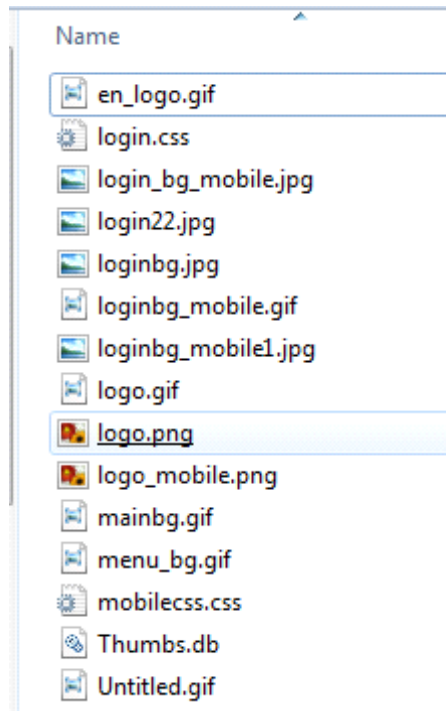

If you are good at HTML coding, I believe you should know very well how to move on next.

If not, let's do an example ---replace the logo on English PC login page

Step 6, prepare a gif format picture with dimensions 468 x 105, name it as `en_logo.gif`, and cover the original one.



en_logo.gif	Date modified: 2012/7/9 15:45	Size: 6.70 KB
GIF File	Dimensions: 468 x 105	Date created: 2012/7/9 15:45

<Original logo>



en_logo.gif	Date modified: 2015/11/24 10:31	Size: 13.7 KB
GIF File	Dimensions: 468 x 105	Date created: 2015/11/24 10:31

<New logo>

When finished, open [login.htm](#) to verify

जवाहरलाल नेहरू विश्वविद्यालय
JAWAHARLAL NEHRU UNIVERSITY

Wireless network [中文](#)

Username

Password

[Clear saved user information](#)

Remember me

Anouncement

If your device is an ios terminal , please follow these steps to turn off the automatic login option for wireless networks:

- (1)Click [Settings] icon on the desktop
- (2)Select Settings in the [Wi-Fi] or [wireless network]
- (3)Select the wireless network you want to connect, click the

The logo on English login page has changed.

Step 7, for other [*.htm](#) customization, read above steps 5 and 6.

Step 8, package the customized files into ZIP format, and upload it to path/portal/zip on wireless controller

Today (3)

- iportal_1.zip
- default.zip
- iportal_1

```
WS6108#copy tftp://172.29.7.1/iportal_1.zip iportal_1.zip
Press Ctrl+C to quit
!
Copy success.
WS6108#
WS6108#dir
Directory of flash:/portal/zip
Number  Properties  Size           Time           Name
-----  -
1       -rwx         86.7k         Thu Nov  5 21:06:03 2015 gateway.zip
2       -rwx         91.0k         Tue Aug 18 23:09:46 2015 custom.zip
3       -rwx         91.0k         Thu Nov  5 21:06:02 2015 default.zip
4       -rw-        110.4k         Tue Nov 24 11:11:07 2015 iportal_1.zip
4 files, 0 directories
281,903,104 bytes data total (241,868,800 bytes free)
536870912 bytes flash total (241,868,800 bytes free)
WS6108#
```



Step 9, apply customized http package to iportal setting.

```
WS6108#conf t
Enter configuration commands, one per line. End with CNTL/Z.
WS6108(config)#web-auth template iportal
WS6108(config.tmplt.iportal)#page-suite iportal_1
WS6108(config.tmplt.iportal)#
WS6108(config)#
WS6108#
```

Note: your iportal web template may not be named as " iportal "

Verification

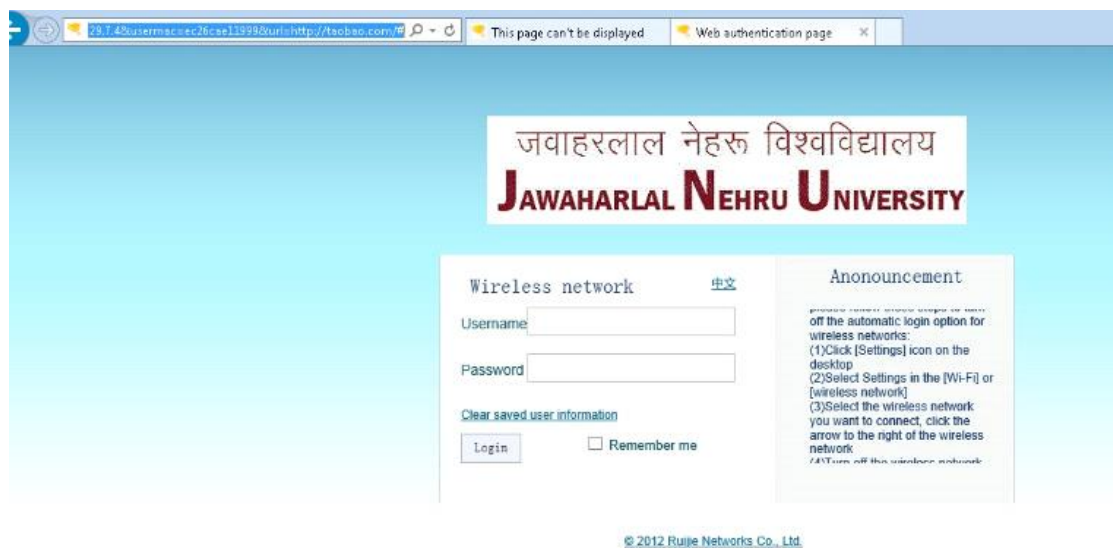
The logo has been replaced.



SMP Built-in Portal Customization

- 1) Login to SMP server ---> "System Maintenance" ----> "Custom Manager Page"

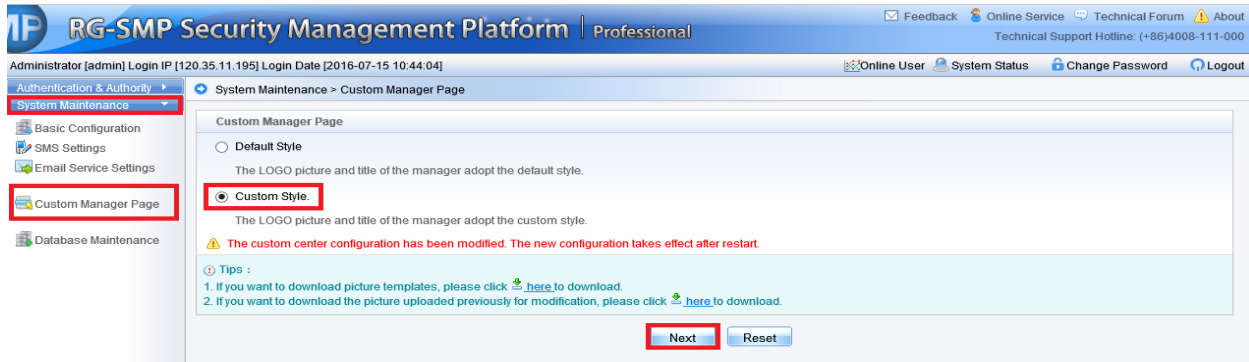

2) Select a specific picture and click "Upload" button

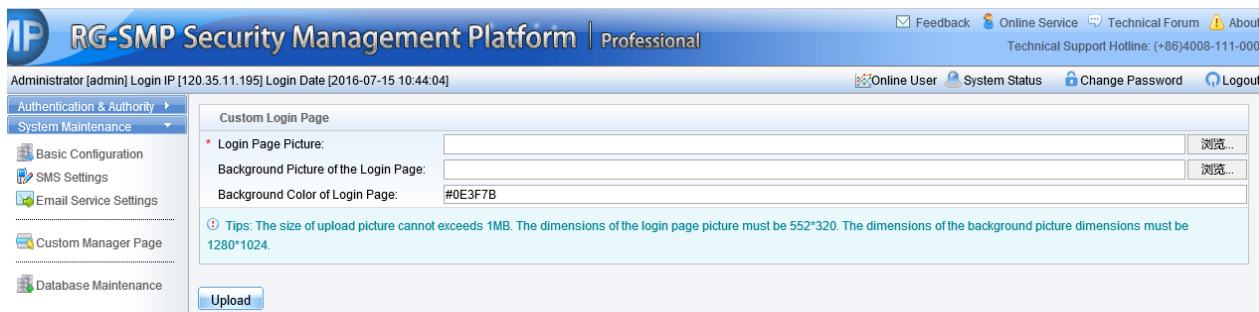

If you want to customize the welcome words on the login page. You could access the "common_user_auth_login" file in SMP server and modify the related characters.

```
<input id="disclaimerEnable" name="disclaimerEnable" type="hidden" value="<c:out value=
<input id="disclaimerTitle" name="disclaimerTitle" type="hidden" value="<c:out value=
<input id="disclaimerContent" name="disclaimerContent" type="hidden" value="<c:out vali
<input id="disclaimerLoginBtn" name="disclaimerLoginBtn" type="hidden" value="<c:out va

<input id="loginActionName" name="loginActionName" type="hidden" value="./webauthservi

<c:if test="`${enableEsaAuthen}`">
  <OBJECT ID="portalObject" CLASSID="CLSID:5744FEFB-DC23-4D1A-A5CE-C8191CC5DD43"
</c:if>

<div id="pageDiv" style="margin: auto; position: relative;">
  <div class="tip" >
    <div class="tip1">xxxxxx</div>
    <div class="tip2">yyyyyy</div>
  </div>
  <div id="bulletin_div" class="bulletin" style="display:none;">
    <div class="bulletin_banner">
      <div id="closeImage" class="bulletin_op" onclick="opBulletin('
    </div>
    <div class="bulletin_content_out">
      <div class="bulletin_content_inside">
        <c:out value='`${normalNotificationBulletin}`' escapexml:
      </div>
    </div>
  </div>
</div>

<div id="formDiv" class="form div">
```

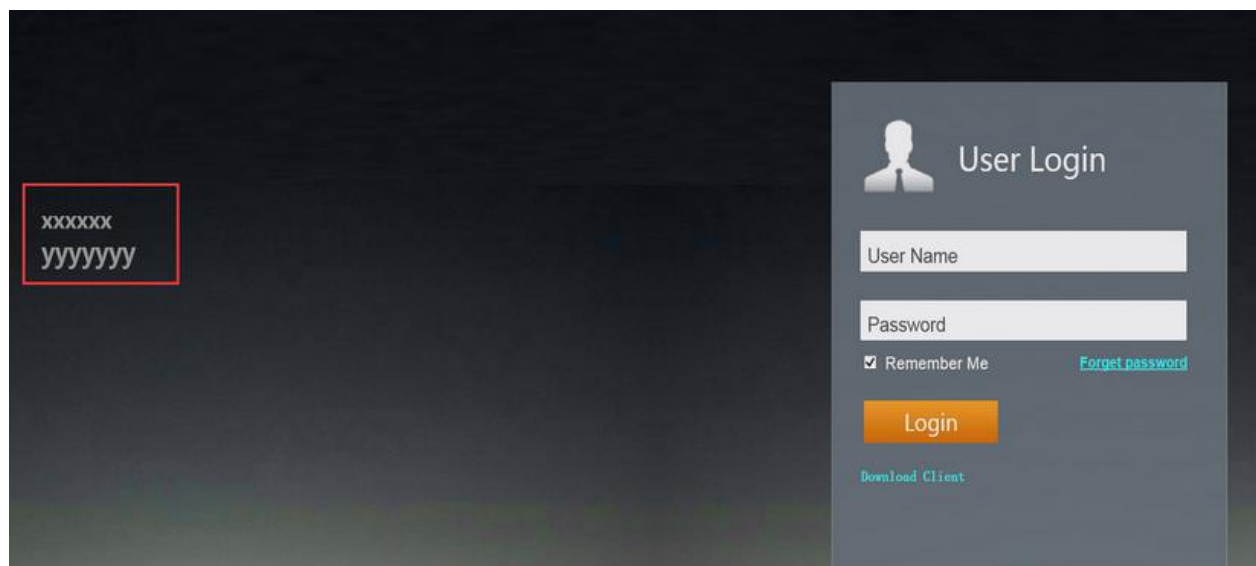

Warm prompt:

You could also customize the web portal page via eweb, for more details, please find the attachment for your reference.

5.9.6 FAQ

5.9.6.1 How to view the information of authenticated users in Web authentication mode?

WS#show web-auth user ?

all Process all users -----Displays all the authentication users.

escape Web-auth user escape -----Display escaped users who connect WeChat accounts to Wi-Fi through MCP.

ip User ip address -----Displays authentication information of an IP address.

mac User MAC -----Displays authentication information of an MAC address.

name User name -----Displays authentication information of a user.

5.9.6.2 How to force a web-auth user offline?

WS#clear web-auth user ?

all Process all users

ip User ip address

mac User MAC

name User name

Note: Before going online, the cleared terminal must be authenticated again.

5.9.6.3 How to display the HTTP redirection configuration

Ruijie#show http redirect

HTTP redirection settings:

server: 172.20.1.100 // Indicates the IP address of the Portal server.

port: 80

homepage: http://172.20.1.100:8888/eportal /index.jsp // Indicates the authentication homepage URL of the Portal server.

session-limit: 255

timeout: 3

Direct sites:

Address	MASK	ARP Binding
-----	-----	-----
172.18.10.1	255.255.255.255	Off // Indicates that the resources can be accessed without authentication.

Direct hosts:

Address	Mask	Port Binding	ARP Binding
-----	-----	-----	-----
192.168.20.1	255.255.255.255	Off	// Indicates that users do not to be authenticated.

5.9.6.4 How to display Web authentication configurations

```
Ruijie#show web-auth portal
```

```
Portal Servers Settings:
```

```
-----  
Ip:      172.18.159.48  
Key:     ruijie  
ref:     2  
-----
```

```
Ip:      172.18.159.46  
Key:     ruijie  
ref:     1
```

```
portalv2 list show
```

```
-----  
Ip:      172.18.159.48  
port:    50100  
ref:     2  
URL format: default  
Status:  Enable
```

```
Ip:      172.18.159.46  
port:    50100  
ref:     1  
URL format: default  
Status:  Enable
```

5.9.6.5 How to display the template and port parameters configured by the device on the AC?

```
WS#sh web-auth template
```

```
Name:      zzs2  
BindMode:  ip-mac-mode  
Type:      v2  
Port:      50100
```

Ip: 2.2.2.2
Url: http://2.2.2.2/eportal/index.jsp

The Portal server uses the local port 50100 to monitor and authenticate non-response packets send by the device and uses the target port 2000 to send all packets to the authentication device.

NAS uses the local port 2000 to monitor all packets send by the Portal server and uses the target port 50100 to send non-response packets to the Portal server.

5.9.6.6 How does the traffic Detection of Web Authentication work

Traffic detection is enabled in Web authentication mode by default. When a user having passing Web authentication has no traffic passing through the device within the specified no traffic period, the device deems that the user has gone offline and kicks the user out.

AP 11.x supports global no traffic detection and wlansec no traffic detection. The wlansec no traffic detection has a higher priority. When wlansec no traffic detection takes effect, global no traffic detection does not take effect.

In global no traffic detection mode, if the user has no traffic in eight hours, the user is kicked off by default. The command is as follows:

```
Ruijie(config)# offline-detect interval xx threshold yy
```

xx indicates the time, which is an integer ranging from 1 to 65535, and the unit is minute. The default value is 8 hours.

yy indicates the traffic size, which is an integer ranging from 0 to 4,294,967,294, and the unit is byte. The default value is 0.

In wlansec no traffic detection mode, if the user has no traffic in 15 minutes, the user is kicked off by default. The command is as follows:

The wlansec no traffic detection has a higher priority. Therefore, users having no traffic in 15 minutes are kicked out in 15 minutes by default.

```
WS(config)#wlansec 7 -----It is the actual authenticated wlansec serial number.
```

```
WS(config-wlansec)#web-auth offline-detect ?
```

```
flow    Configure no flow threshold
```

```
interval Configure no flow interval
```

5.9.6.7 Does built-in Web authentication support pushing advertisement without authentication or pushing advertisement after authentication?

No.

5.9.6.8 Can an account be logged on by only a single user in local built-in Web authentication mode?

No. To control the number of simultaneous logons to the terminal, a separate authentication server should be configured and the server should support this function.

5.9.6.9 the traffic keepalive detection is based on the user MAC address or user name in Web authentication mode?

It is based on the user MAC address.

5.9.6.10 What are the protocol and port used by wireless second-generation Web authentication?

The protocol is UDP.

The packet target port of the Portal server is port 2000, which means that the port used by the AC to send packets is port 2000.

5.9.6.11 Is wireless user data encrypted at the air interface in wireless Web authentication?

If only Web authentication is enabled, the data is not encrypted at the air interface. You can configure WPA2 to encrypt the data.

5.9.6.12 Can the Portal server IP address be configured to a domain name on the AC?

Yes. The URL should be added to the URL whitelist. On AC 11.1(5)b8 or a later version, you are recommended to run the `free-url url xx` command to make the configuration in global mode.

For example, run the `WS(config)#free-url url www.google.com` command to add www.google.com in the whitelist.

5.9.6.13 Does the AC support https redirection and which redirection port need to be configured?

Currently, only ACs of 11.1(5)B8p3, 11.1(5)B9P5, office-wifi and later versions support https redirection. The redirection ports 433 and 8433 must be configured as follows:

```
Ruijie(config)#http redirect port 443
```

```
Ruijie(config)#http redirect port 8443
```

5.9.6.14 If the terminal uses a static IP address in Web authentication mode, can the IP address of the terminal be uploaded to the server?

The AC 11.1(5)b8p3 and later versions allow you to run the **dot1x get-static-ip enable** command to upload the static IP address of the wireless terminal to the server.

5.9.6.15 How to bypass specific devices in Web authentication mode?

In some applications, after connecting to a wireless network, users can access some network resources (for example, intranet websites) without authentication. You can run the **http redirect direct-site x.x.x.x** command (**x.x.x.x** is the IP address of free-authenticated resources) to add the IP address of these websites to the free-authenticated network resource list.

5.9.6.16 How to fix when “the authentication device does not exist” error occurs during Web authentication?

After confirming that the AC is added to the server and the authentication key configurations are consistent, check whether the AC can ping the server and modify the source IP address of the Portal server and RADIUS server according to actual situation. Add the VLAN of IP addresses of servers that can be pinged.

```
Ruijie(config)#ip portal source-interface vlan 1
```

```
Ruijie(config)#ip radius source-interface vlan 1
```

5.9.6.17 Timeout connection error is reported when the built-in portal web authentication fails.

- (1) If the communication between the AC and the RADIUS server fails, check whether the routes are different because multiple IP addresses are set for the RADIUS server.
- (2) No AC is added to the RADIUS server. Check whether the SAM is added with an AC.
- (3) The RADIUS key configuration is inconsistent. Check whether the SAM is added to the AC for more than two times (the IP address of the uplink interface of the AC is added).
- (4) The proxy is enabled for the Internet Explorer but the built-in Portal does not support the proxy. Disable the proxy of the Internet Explorer.

5.9.6.18 Error code analysis for User Offline in Second Generation Web Authentication Mode

01: The user actively goes offline.

02: The port is disconnected. On a wireless network, STAMG notifies STA to go offline. In this case, contact STAMG owner to locate the cause.

03: The service is unavailable mainly due to connection interruption.

- 04: Idle status times out. The user having no traffic is kicked out.
- 05: Session times out. The duration reaches.
- 06: The administrator resets the port or session to kick out users from the RADIUS server, kick out escaped users after restoring the Portal server, or run the clear command to delete users.
- 07: The administrator restarts NAS.
- 08: The port has an error and required to interrupt the session
- 09: NAS has an error and required interrupting the session.
- 10: NAS requires interrupting the session due to other reasons.
- 11: NAS is restarted accidentally.
- 12: NAS thinks there is no need to retain the port and interrupts the session.
- 13: NAS interrupts the session to allocate this port.
- 14: NAS interrupts the session to suspend the port.
- 15: NAS fails to provide the required service.
- 16: NAS interrupts the current session to call back the new session.
- 17: Information entered by the user is incorrect.
- 18: The host requires interrupting the session.
- 103: The IP or MAC address has changed or occupied.
- 115: The service is switched over.
- 122: The traffic is exhausted.
- 250: The low-traffic user is kicked out. It is a unique attribute of Ruijie AP and the cause is same to code 4.
- 500: Authentication times out. The RADIUS authentication packet is not responded within the time limit. This attribute is available for wireless wlog module and will be provided for SNC later.
- 501: Authentication is denied by the RADIUS server. This attribute is available for wireless wlog module and will be provided for SNC later.
- 502: The number of users on the device has reached the upper limit. This attribute is available for wireless wlog module and will be provided for SNC later.

5.9.6.19 Definition of errcode in the Portal Protocol

(1) When the Type value is set to 2, in ack_challenge:

ErrCode = 0: The AC informs the Portal server that the Challenge request is successful.

ErrCode = 1: The AC informs the Portal server that the Challenge request is denied because the portal packet has an error or the user does not exist on the AC.

ErrCode = 2: The AC informs the Portal server that the link is created. When another authentication request is sent after the user has passed authentication, errcode2 is returned.

ErrCode = 3: The AC informs the Portal server that a user is being authenticated and the request should be sent later. The AC has sent an authentication request to the RADIUS server but RADIUS server does not send response. If the Portal server sends req_challenge during this period of time, errcode3 is returned.

ErrCode = 4: The AC informs the Portal server that the user's Challenge request fails because the AC has an inner error.

Note: When the ErrCode is not 0, see the ErrID value to find the cause.

(2) When the Type value is set to 4, in ack_auth:

ErrCode = 0: The AC informs the Portal server that the user authentication is successful.

ErrCode = 1: The AC informs the Portal server that the user authentication request is denied because the portal packet has an error (due to incorrect req_id or portal attribute) or the RADIUS server returns the authentication rejection packet.

ErrCode = 2: The AC informs the Portal server that the link has been created.

ErrCode = 3: The AC informs the Portal server that a user is being authenticated and the request should be sent later.

ErrCode = 4: The AC informs the Portal server that the user's authentication request fails because of an error.

Note: When the ErrCode is not 0, see the ErrID value to find the cause.

5.9.6.20 The URL cannot be redirected

If this problem occurs, check whether the HTTP packet sent by the terminal is intercepted, processed, and redirected by the AC.

The following are common causes:

- (1) The STA cannot access the Internet or communication is abnormal. You can add the STA to free-authentication test to check whether the terminal can obtain the correct IP address and learn the gateway ARP.
- (2) The terminal cannot parse the domain name or the page cannot be redirected to the entered IP address. For example, if the access domain name or IP address is **not in the direct-pass list of AC**, the domain name must be able to be parsed.
- (3) **The user is not a free-authenticated user**. Packets of free-authenticated users are certainly not interrupted by the AC.
- (4) No user VLAN is configured for the AC and thus the packet is discarded by the AC after it is forwarded to the AC.
- (5) An https IP address is entered but https redirection is not configured.
- (6) The addresses conflict. The terminal of which the IP address is same to that of an online AP but the MAC address is different cannot be redirected. You can run the **web-auth sta-preemption enable** command to solve the problem.
- (7) The web-auth dhcp-check is configured but ip dhcp snooping is not enabled on the AC.
- (8) The portal server is not called under wlansec on the AC.
- (9) The AC version is too low. Upgrade the AC to the latest version which is available on Ruijie official website.

5.9.6.21 The Portal page cannot popup.

- (1) After obtaining the URL redirected by the AC, the terminal directly uses the URL to access the Portal page. If the Portal page is not displayed, check the interconnectivity between the terminal and the Portal Server. If the terminal can ping the Portal server, check whether intermediate devices filter out the http packets.

(2) The problem occurs when the parameter or format of the URL does not conform to the requirement of the Portal Server. Pay special attention during connection to a third-party server.

Some servers require checking the URL parameter or format, or specify the value of some parameter. Confirm whether the parameter or format is supported by the AC and the AC is configured accordingly.

5.9.6.22 The web-authentication user is forced offline.

(1) The dhcp snooping entry shows that the terminal IP address conflicts. In this case, authenticated users are forced to go offline.

(2) Different terminals use the same user name.

(3) The traffic keepalive time threshold reaches.

(4) When a user is disconnected from the wireless network for five minutes, the user's Web authentication entry is deleted by default.

(5) The accounting-update is not enabled or its configuration is different on the AC and the server.

(6) The user is forced by the server to go offline (due to the RADIUS extended attribute).

5.9.6.23 Web authentication fails and the server fails to receive auth_req response packets from the device.

Possible Cause:

The authentication request packet sent by the Portal server does not arrive at the AC and is discarded by intermediate devices.

Troubleshooting Method:

(1) When packets can be captured, create images for packets at uplink port of the AC to see whether the authentication request packet arrives at the AC. If not, when auth-req is resent by the Portal server, the AC returns ack_auth and the error code indicates that the user is being authenticated.

(2) The problem is generally because packets from the Portal server are not allowed to pass through due to firewall between the AC and the Portal server.

5.10 WDS

5.10.1 FIT AP

5.10.1.1 Point-to-Point Structure

Overview

Point-to-Point Structure

Since wireless devices are connected to each other, this structure is suitable for a network connecting two fixed points. The network topology is shown below:

Root Bridge + one Non-root Bridge

The wired interface of the root bridge is connected to the wired network, and its wireless interface is connected to the non-root bridge; The wireless interface of the non-root bridge is connected to the root bridge, and its wired interface is connected to the wired network; Two separate wired networks are connected in a wireless manner through the wireless bridging between the root bridge and the non-root bridge.

I. Network Topology

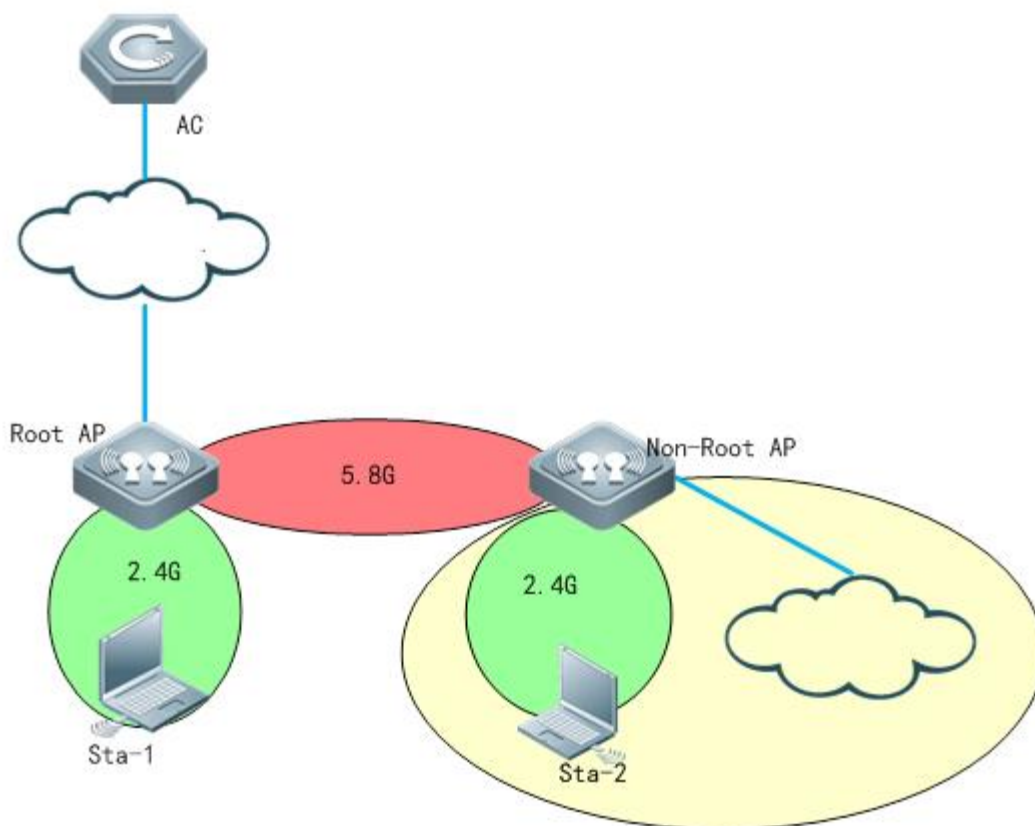

Notes

1. Wlan forwarding mode should be configured as centralized forwarding mode.
2. The ip address of root side and non-root side should in the same subnet
3. Non-root AP needs to establish the capwap tunnel with AC after bridging with the root AP
4. In this topology, the dhcp pool of AP and STA are on AC

II. Configuration Steps

【Controller】

1.1 Make sure that Root AP has established capwap tunnel with AC, verify by following command in controller:

```
Ruijie#sh capwap state
CAPWAP tunnel state, 1 peers, 1 is run:
Index      Peer IP      PortState
1          110.10.10.10  5246      Run
```

1.2 Configure Root-AP by using following command in controller:

```
AC(config)#wlan-config 100 wds-test-root ----->configure a special ssid for wds
AC(config-wlan)#exit
AC(config)#wlan-config 200 wds-test-2.4G----->Configure assid for 2.4g signal cover
AC(config-wlan)#exit
AC(config)#vlan 100 ----->Configure vlan for wds AP
AC(config-vlan)#exit
AC(config)#vlan 200 ----->Configure vlan for clients
AC(config-vlan)#exit
AC(config)#int vlan 100 ----->Configure dhcp pool for wds AP
AC(config-if-VLAN 100)#ip address 90.0.100.254 255.255.255.0
AC(config-if-VLAN 100)#exit
AC(config)#int vlan 200 ----->Configure dhcp pool for clients
AC(config-if-VLAN 200)#ip address 90.0.200.254 255.255.255.0
AC(config-if-VLAN 200)#exit
AC(config)#ip dhcp pool vlan-100
AC(dhcp-config)#network 90.0.100.0 255.255.255.0
AC(dhcp-config)#default-router 90.0.100.254
AC(dhcp-config)#option 138 ip 10.10.10.10
AC(dhcp-config)#exit
AC(config)#ip dhcp pool vlan-200
AC(dhcp-config)#network 90.0.200.0 255.255.255.0
AC(dhcp-config)#default-router 90.0.200.254
AC(dhcp-config)#dns-server 192.168.58.110
AC(dhcp-config)#exit
AC(config)#service dhcp ----->enable dhcp service
AC(config)#ap-group wds -----> configure a new ap-group to associate the wlan-id and vlan
AC(config-group)#interface-mapping 100 100 radio 2
```

```

AC(config-group)#interface-mapping 200 200 radio 1
AC(config-group)#exit
AC(config)#ap-config ap630 -----> configure the AP which needs to be set as Root-AP in WDS
AC(config-ap)#ap-group wds
AC(config-ap)#station-role root-bridge bridge-wlan 1 radio 2
AC(config-ap)#end
AC#write

```

【Non-AP】

Shutdown the port on POE switch which connected to Non-AP. It's very important. It will help to prevent looping after change the AP to WDS mode.

1.3 Change AP to fat-mode

```

Ruijie#conf
Ruijie#(config)ap-mode fat

```

1.4 Connect AP (with ip add 192.168.110.1), and run the following command in this AP:

```

Ruijie#conf
Ruijie(config)#int dot11radio 2/0
Ruijie(config-if-Dot11radio 2/0)#station-role non-root-bridge
Ruijie(config-if-Dot11radio 2/0)#parent ssid wds-test-root -----> bridge SSID
Ruijie(config-if-Dot11radio 2/0)#wds pre-config create
Ruijie(config-if-Dot11radio 2/0)#exit

```

1.5 Change the AP to fit mode

```

Ruijie#conf
Ruijie#(config)ap-mode fit ----->change AP to fit mode, then ap will reload automatically, the wds will be setted up successfully.
Press RETURN to get started
*Jan 1 00:00:31: %LINK-3-UPDOWN: Interface WBI 2/0, changed state to up.
*Jan 1 00:00:32: %LINK-3-UPDOWN: Interface GigabitEthernet 0/2, changed state to down.
*Jan 1 00:00:32: %LINEPROTO-5-UPDOWN: Line protocol on Interface GigabitEthernet 0/2, changed state to down.
*Jan 1 00:00:32: %LINEPROTO-5-UPDOWN: Line protocol on Interface Dot11radio 1/0, changed state to up.
*Jan 1 00:00:32: %LINEPROTO-5-UPDOWN: Line protocol on Interface Dot11radio 2/0, changed state to up.

```

```
*Jan 1 00:00:32: %LINEPROTO-5-UPDOWN: Line protocol on Interface BVI 1, changed state to up.
*Jan 1 00:00:33: %LINEPROTO-5-UPDOWN: Line protocol on Interface WBI 2/0, changed state to up.
*Jan 1 00:00:41: %CAPWAP-6-STATE_CHANGE: Capwap discovery state changed, from <IDLE> to <DISC>
*Jan 1 00:00:47: %DHCP_CLIENT-6-ADDRESS_ASSIGN: Interface BVI 1 assigned DHCP address 10.1.1.15, mask
255.255.255.0.
Ruijie#ping 10.1*Jan 1 00:00:56: %CAPWAP-6-STATE_CHANGE: Capwap discovery state changed, from <DISC> to
<SELECT>
*Jan 1 00:00:56: %CAPWAP-6-STATE_CHANGE: Capwap discovery state changed, from <SELECT> to
<SUCCESS>
*Jan 1 00:00:56: %CAPWAP-6-STATE_CHANGE: (peer - 1) [10.10.10.10] capwap state changed, from <Idle> to
<Join>
*Jan 1 00:00:56: %CAPWAP-6-STATE_CHANGE: (peer - 1) [10.10.10.10] capwap state changed, from <Join> to
<Configure>
*Jan 1 00:00:56: %CAPWAP-6-STATE_CHANGE: (peer - 1) [10.10.10.10] capwap state changed, from <Configure>
to <Data Check>
*Jan 1 00:00:56: %CAPWAP-6-STATE_CHANGE: (peer - 1) [10.10.10.10] capwap state changed, from <Data Check>
to <Run>
*Jan 1 00:00:56: %CAPWAP-5-PEER_NOTIFY_UP: Peer <10.10.10.10: 5246: 1> UP.
```

1.6 After the NON-ROOT is online, it can be distributed all relevant configuration by AC

```
AC(config)#wlan-config 2 WDS-NONROOT-2.4
AC(config)#ap-group NONROOT
AC(config-group)#interface-mapping 2 200 radio 1 ap-wlan-id 1
AC(config)#ap-config 1414.4bc2.3156
AC(config-ap)#ap-group NONROOT
```

III. Verification

1.1 Check the bridge status on wlan controller

```
AC#show ap-config wds-bridge summary
```

```
WS5708#sh ap-config wds-bridge-info summary
Ap Name Mac Address      Radio  Station-Role
-----
1414.4bc2.3156  1414.4bc2.3156  2NONROOT-BRIDGE
630wdsxia      28fb.d311.48d9  2ROOT-BRIDGE
```

```
AC#show ap-config wds-bridge-info AP630-ROOT radio 2
```

```
WS5708#sh ap-config wds-bridge-info 630wdsxia radio 2
WDS-MODE: ROOT-BRIDGE
BRIDGE-WLAN:
Status: OK
WlanID 1, SSID wds-test-root, BSSID 06fb.d311.48dd
```

```
WBI 2/0
NONROOT 0014.4bc2.315a
WS5708#sh ap-config wds-bridge-info 1414.4bc2.3156 radio 2
WDS-MODE: NONROOT-BRIDGE
MAC: 0014.4bc2.315a
```

```
WBI 2/0
ROOT 06fb.d311.48dd
```

1.2 Check the bridge status on Root AP and Non-root AP.

```
AP630-ROOT#show dot11 wds-bridge-info 2/0
```

```
Ruijie#sh dot wds-bridge-info 2/0
WDS-MODE: ROOT-BRIDGE
BRIDGE-WLAN:
Status: OK
WlanID 1, SSID wds-test-root, BSSID 06fb.d311.48dd
```

```
WBI 2/0
NONROOT 0014.4bc2.315a
LinkTime 0:22:05
SendRate 195.0M Mbps,RecvRate 58.5M Mbps,RSSI 55
Ruijie#
Ruijie#
Ruijie#ping 10.10.10.10
Sending 5, 100-byte ICMP Echoes to 10.10.10.10, timeout is 2 seconds:
< press Ctrl+C to break >
!!!!
Success rate is 100 percent (5/5), round-trip min/avg/max = 1/1/1 ms.
Ruijie#
```



```
AP630-NONROOT#show dot11 wds-bridge-info 2/0
```

```
Ruijie#sh dot wds-bridge-info 2/0
WDS-MODE: NONROOT-BRIDGE
MAC: 0014.4bc2.315a
CONFIG-MAC:
CONFIG-SSID:wds-test-root
```

```
WBI 2/0
ROOT 06fb.d311.48dd
LinkTime 0:22:17
SendRate 58.5M Mbps,RecvRate 195.0M Mbps,RSSI 54
Ruijie#
Ruijie#
Ruijie#ping 10.10.10.10
Sending 5, 100-byte ICMP Echoes to 10.10.10.10, timeout is 2 seconds:
< press Ctrl+C to break >
!!!!
Success rate is 100 percent (5/5), round-trip min/avg/max = 1/4/11 ms.
Ruijie#
```

5.10.2 FAT AP

5.10.2.1 Point-to-Point Structure

Overview

Point-to-Point Structure

Since wireless devices are connected to each other, this structure is suitable for a network connecting two fixed points. The network topology is shown below:

Root Bridge + one Non-root Bridge

The wired interface of the root bridge is connected to the wired network, and its wireless interface is connected to the non-root bridge; The wireless interface of the non-root bridge is connected to the root bridge, and its wired interface is connected to the wired network; Two separate wired networks are connected in a wireless manner through the wireless bridging between the root bridge and the non-root bridge.

I. Network Topology

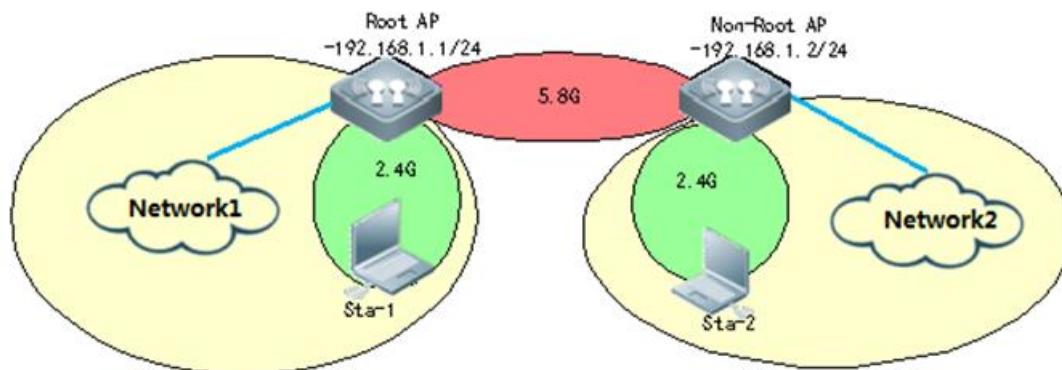

Notes

1. In FAT AP WDS scene, bridging WLAN need to be in OPEN authentication.
2. FAT AP can support 2 bridging ways, mac-address and ssid.The following configuration will take mac-address bridging for example.
3. In AP630 B8 version or later, it can support WDS encryption, but only RSN's and WPA's AES encryption.It doesn't support Tkip encryption.
4. If the distance of wireless transmission in WDS is over 1000m, you need to add a command:

```
interface Dot11radio 2/0
peer-distance 4000 ----->actual distance is 2000m
```

Please set the distance to a larger value (2-3 times the actual distance)

II. Configuration Steps

【ROOT-AP】

1. Create bridging VLAN

```
AP-1(config)#vlan 10
AP-1(config-vlan)#exit
```

2. Configure bridging WLAN-ID

```
AP-1(config)#dot11 wlan 1
AP-1(dot11-wlan-config)#ssid ruijie-test
```

3. Configure radio interface

```
AP-1(config)#interface dot11radio 2/0
AP-1(config-if-Dot11radio 2/0)#encapsulation dot1Q 10 ----->encapsulation vlan
AP-1(config-if-Dot11radio 2/0)#radio-type 802.11a ----->set radio 5.8G
AP-1(config-if-Dot11radio 2/0)#channel 149 ----->set channel 149
AP-1(config-if-Dot11radio 2/0)#chan-width 40
```

```
AP-1(config-if-Dot11radio 2/0)#station-role root-bridge bridge-wlan 1 ----->set ap as root-ap
AP-1(config-if-Dot11radio 2/0)#wlan-id 1 ----->SSID mapping
```

4. Check BSSID

```
AP-1#show dot11 mbssid
```

```
Ruijie#sh do mbssid
name: Dot11radio 2/0
wlan id: 1
ssid: ruijie-test
bssid: 061a.a97f.1114
```

5. Configure AP bvi interface

```
AP-1(config)#interface bvi 10
AP-1(config-if-BVI 10)#ip address 192.168.1.254 255.255.255.0
```

6. Configured interface

```
AP-1(config)#interface gigabitEthernet 0/1
AP-1(config-if-GigabitEthernet 0/1)#encapsulation dot1Q 10
```

7. Enable AP wireless broadcast

```
AP-1(config)#data-plane wireless-broadcast enable
```

8. Configure ssid for coverage

```
AP-1(config)#dot1 wlan 2 ----->create WLAN
AP-1(dot11-wlan-config)#ssid ruijie-wds-test ----->create ssid
AP-1(dot11-wlan-config)#exit
AP-1(config)#vlan 20 ----->creat Vlan
AP-1(config-vlan)#exit
AP-1(config)#int dot11radio 1/0.1
AP-1(config-subif-Dot11radio 1/0.1)#encapsulation dot1Q 20 ----->configure radio interface encapsulation
vlan
AP-1(config-subif-Dot11radio 1/0.1)#exit
AP-1(config)#int dot11radio 1/0
AP-1(config-if-Dot11radio 1/0)#wlan-id 2
```

【Non-ROOT AP】

1. Creat bridging VLAN

```
AP-2(config)#vlan 10
AP-2(config-vlan)#exit
```

2. Configure radio

```
AP-2(config)#interface dot11radio 2/0
AP-2(config-if-Dot11radio 2/0)#encapsulation dot1Q 10 ----->encapsulation vlan
AP-2(config-if-Dot11radio 2/0)#station-role non-root-bridge ----->set AP role as non-root bridge
AP-2(config-if-Dot11radio 2/0)#parent mac-address 061a.a97f.1114 ----->set BSSID,and you can use "parent ssid
xxxx" to match the SSID
```

3 Configure AP interface BVI

```
AP-2(config)#interface bvi 10
AP-2(config-if-BVI 10)#ip address 192.168.1.253 255.255.255.0
```

4. Enable AP wireless broadcast

```
AP-2(config)#data-plane wireless-broadcast enable
```

5. Configure ssid for coverate

```
AP-1(config)#dot1 wlan 2 ----->create WLAN
AP-1(dot11-wlan-config)#ssid ruijie-wds-test ----->create ssid
AP-1(dot11-wlan-config)#exit
AP-1(config)#vlan 20 ----->creat Vlan
AP-1(config-vlan)#exit
AP-1(config)#int dot11radio 1/0.1
AP-1(config-subif-Dot11radio 1/0.1)#encapsulation dot1Q 20 ----->configure radio interface encapsulation vlan
AP-1(config-subif-Dot11radio 1/0.1)#exit
AP-1(config)#int dot11radio 1/0
AP-1(config-if-Dot11radio 1/0)#wlan-id 2
```

III. Verification

Check bridging state

```
AP-1#show dot1 associations all-client
RADIO-ID WLAN-IDADDRAD CHAN RATE_DOWN RATE_UP RSSI ASSOC_TIME IDLE TXSEQ
RXSEQ ERP STATE CAPS HTCAPS
2100:14:4b:6f:b8:361149 144.5M144.5M600:00:32 15565535 0x00x3 Es S
```

```

AP-1#ping 192.168.1.253
Sending 5, 100-byte ICMP Echoes to 192.168.1.10, timeout is 2 seconds:
< press Ctrl+C to break >
!!!!
Success rate is 100 percent (5/5), round-trip min/avg/max = 2/11/28 ms.

Ruijie#show dot11 wds-bridge-info 2/0
WDS-MODE: ROOT-BRIDGE
BRIDGE-WLAN:
Status: OK
WlanID 1,  SSID ruijie-test,  BSSID 061a.a97f.1114
WBI 2/0
NONROOT 0014.4b6f.b836
LinkTime 0:00:47
SendRate 130.5M Mbps, RecvRate 133.5M Mbps, RSSI 60

```

5.10.2.2 Point-to-Multipoint Structure

Scenario

Point-to-Multipoint Structure

Since wireless devices are connected from one point to multiple points, this structure is suitable for a network with a central point and multiple remote points. The network topology is shown below:

Root Bridge + multiple Non-root Bridges

The root bridge serves as the root node, with its wireless interfaces being connected multiple non-root bridges.

The non-root bridges serve as leaf nodes, with their wireless interfaces being connected to the root bridge and wired interface to the designated wired network.

I. Requirements

Root AP and non-root AP need to be in the same subnet. And please make sure the model of root AP and non-root AP are the same.

II. Network Topology

Non-root AP	Root AP	Non-root AP
192.168.1.253 255.255.255.0	192.168.1.254 255.255.255.0	192.168.1.252 255.255.255.0

AP-2 ((((AP-1))) AP-3

III. Configuration Steps

Root-AP

1. Create a vlan for bridge

```
AP-1(config)#vlan 10
AP-1(config-vlan)#exit
```

2. Configure bridge WLAN

```
AP-1(config)#dot11 wlan 1
AP-1(dot11-wlan-config)#ssid ruijie-test
```

3. Configure radio for WDS

```
AP-1(config)#interface dot11radio 2/0
AP-1(config-if-Dot11radio 2/0)#encapsulation dot1Q 10 ----->encapsulate vlan
AP-1(config-if-Dot11radio 2/0)#station-role root-bridge bridge-wlan 1 ----->Radio mode Root-bridge and binding
WLAN 1
AP-1(config-if-Dot11radio 2/0)#wlan-id 1
```

4. Verify wlan signal and BSSID

```
AP-1#show dot11 mbssid
```

```
Ruijie#sh do mbssid
name: Dot11radio 2/0
wlan id: 1
ssid: ruijie-test
bssid: 061a.a97f.1114
```

5. Configure BVI interface

```
AP-1(config)#interface bvi 10
AP-1(config-if-BVI 10)#ip address 192.168.1.254 255.255.255.0
```

Non-Root (AP2 and AP3)

1. Create a vlan for bridge

```
AP-2(config)#vlan 10
AP-2(config-vlan)#exit
```

2. Configure radio for WDS

```
AP-2(config)#interface dot11radio 2/0
```

```

AP-2(config-if-Dot11radio 2/0)#encapsulation dot1Q 10
AP-2(config-if-Dot11radio 2/0)#station-role non-root-bridge ----->Radio mode non-root-bridge
AP-2(config-if-Dot11radio 2/0)#parent mac-address 061a.a97f.1114 ----->Binding the Root-bridge BSSID(You can
see this by step 4 on Root-AP configuration)
Or
AP-2(config-if-Dot11radio 2/0)#parent ssid ruijie-test ----->Binding the WDS SSID
(ruijie-test was configured on Root-AP step 2)

```

3. Configure BVI interface

```

AP-2(config)#interface bvi 10
AP-2(config-if-BVI 10)#ip address 192.168.1.253 255.255.255.0

```

4. Configure physical interface

```

AP-2(config)#interface gigabitEthernet 0/1
AP-2(config-if-GigabitEthernet 0/1)#encapsulation dot1Q 10

```

IV. Verification

On Root side

```

AP-1#show dot11 wds-bridge-info 2/0
WDS-MODE: ROOT-BRIDGE
BRIDGE-WLAN:
  Status: OK
  WlanID 1,  SSID ruijie-test,  BSSID 061a.a97f.1114 ----->AP-1 BSSID

WBI 2/0
  NONROOT 0014.4b6f.b836 ----->AP-2 MAC address
  LinkTime 0:00:47
  SendRate 130.5M Mbps,  RecvRate 133.5M Mbps,  RSSI 60

WBI 2/1
  NONROOT 0a25.d311.48ca ----->AP-3 MAC address
  LinkTime 0:00:47
  SendRate 130.5M Mbps,  RecvRate 133.5M Mbps,  RSSI 60

```

Non-Root side

```
Ruijie#sh dot wds-bridge-info 2/0
WDS-MODE: NONROOT-BRIDGE
MAC: 0014.4b6f.b836 ----->AP-2 MAC address
CONFIG-MAC:
CONFIG-SSID:wds-test-root
WBI 2/0
    ROOT 061a.a97f.1114 ----->AP-1 BSSID
LinkTime 0:00:47
    SendRate 58.5M Mbps,   RecvRate 195.0M Mbps,   RSSI 54
```

Ping testing

```
AP-1#ping 192.168.1.253 -----> AP-2 ip address
Sending 5, 100-byte ICMP Echoes to 192.168.1.10, timeout is 2 seconds:
< press Ctrl+C to break >
!!!!
Success rate is 100 percent (5/5), round-trip min/avg/max = 2/11/28 ms.

AP-1#ping 192.168.1.252 -----> AP-3 ip address
Sending 5, 100-byte ICMP Echoes to 192.168.1.252, timeout is 2 seconds:
    < press Ctrl+C to break >
!!!!
Success rate is 100 percent (5/5), round-trip min/avg/max = 1/7/31 ms.
```

5.10.3 FAQ

5.10.3.1 How many bridges does AP630 support?

One root AP supports four none-root AP.

5.10.3.2 Is asso-rssi supported in a bridging environment?

No currently. The processing method in bridging mode is different from that when an ordinary terminal is connected to the underlying layer. The asso-rssi function is applicable for wireless users in normal access mode.

5.10.3.3 How to clear non-root AP configurations?

When the AP is online, run the following command:

```
ap-config xx
```

station-role root-ap radio 2

Or

ap-config xx

wds pre-config delete

The command must be run when the AP is online.

5.10.3.4 What are precautions for multi-hop bridging?

In multi-hop bridging mode, to guarantee the bridging link quality, channels for each of hops must be different.

For example, set channel 60 for the first hop, channel 100 for the second hop, and channel 149 for the third hop.

5.10.3.5 What is the signal strength requirement to guarantee the bridging link and video transmission quality?

Use the multi-hop bridging scenario in AP630 series products as an example.

The bridging uplink of the root bridge is called as the main link. To ensure the main link stability, the uplink RSSI must be **at least 30**. The link between the root bridge and a non-root bridge is called as a single link. To ensure the single link stability, **the uplink RSSI must be at least 25**. If the signal strength is lower than the specified value, adjust or change the AP location, to avoid that the video cannot be transmitted due to too low bridging performance caused by weak signal.

5.10.3.6 How to fix when modification to the non-root AP do not take effect on the AC?

All the commands for modifying the non-root bridge configuration take effect only after the **wds config commit** command is run.

In **ap-config** mode, run the **wds config [clear | commit] radio radio-id** command. The parameters are described below:

clear: Clears WDS configuration that does not take effect.

commit: Commits WDS configuration that does not take effect. After the operation, the bridge is disconnected and then connected.

radio radio-id: Indicates the radio ID configured on the AC.

If the AP is in non-root mode, its radio enters the wds edit mode. At this time, most of wds commands do not take effect immediately. You can run the **show ap-config wds-config** command to display the configurations. After confirming that the configurations are correct, run this command to commit the modification.

5.10.3.7 Is local forwarding mode supported when fit AP630s are bridged? Can multiple VLANs be bridged transparently?

Yes. The root bridge AP and non-root bridge AP must bridge VLANs transparently (run the **bridge-vlan x** command in ap-config mode). Assuming vlanx and vlany are VLANs required by non-root APs, the configuration method is as follows:

```
ap-config root bridge ap name
```

```
    bridge-vlan x
```

```
    bridge-vlan y
```

```
    exit
```

```
ap-config non-root bridge ap name
```

```
    bridge-vlan x
```

```
    bridge-vlan y
```

```
    exit
```

5.11 Load Balance

I. Requirements

Enable even distribution of STAs on multiple APs in a load balancing group.

Notes

Load balancing is applicable only to STAs that are associated, but not to STAs that are disassociated. Therefore, after STAs are disassociated, the traffic difference between APs or the STA quantity difference may exceed the threshold.

Load balancing takes effect only on the same type of radios (2.4 GHz or 5 GHz). If the types of radios are different, load balancing is performed only when the AP reports that the STAs are capable of dual-band operation. Otherwise, the 2.4 GHz STAs may fail to be associated with 2.4 GHz radios when no STA is associated with 5 GHz radio.

After the traffic-based balancing group is configured to use the traffic information uploaded by APs, APs must upload the traffic information to the AC at a regular interval because the traffic only exists on APs and is not routed to the AC.

During this interval, the traffic information on the AC does not change. At this time, if the traffic between APs is not balanced, STAs cannot be associated with APs with heavy traffic until the APs upload the traffic information to the AC.

II. Network Topology

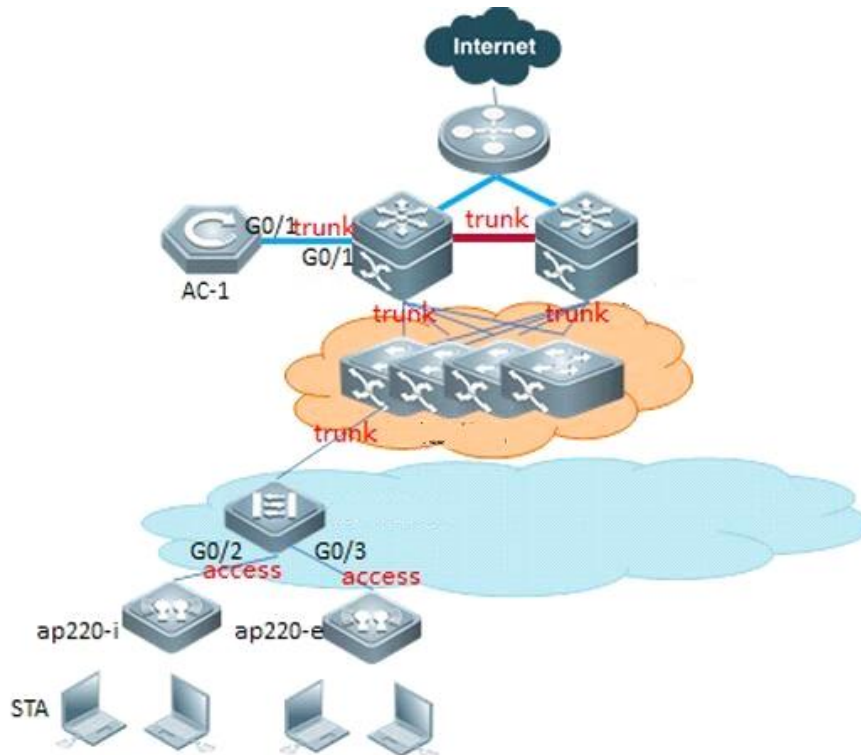

AP need to broadcast the same SSID signal in load-balance group.

III. Configuration Steps

1. Number-based

- 1) Create a number-based balancing group on the AC, named test1.

```
Ruijie(config)#ac-controller
Ruijie(config-ac)#num-balance-group create test1
```

- 2) Configure the load balance threshold

```
Ruijie(config-ac)#num-balance-group num test1 10 ----> when the difference of more than 10 STAs on APs, the AP
which carries more users will not response new associations.
```

- 3) Add APs to the load balance group

```
Ruijie(config-ac)#num-balance-group add test1 ap320-1 ---->put AP named ap320-i into load balance group
Ruijie(config-ac)#num-balance-group add test1 ap320-2
```

- 4) Configure the maximum times of load balancing when STA associates failure

```
Ruijie(config-ac)#sta-balance num-limit enable
```

Note: It is necessary to configure the maximum times shown as above in case the STA could not connect to the network successfully.

2. Traffic-based

- 1) Create a flow-based balancing group on the AC, named flow_huiyi

```
Ruijie(config)#ac-controller
Ruijie(config-ac)#flow-balance-group create flow_huiyi
```

- 2) Configure the load balance threshold

```
Ruijie(config-ac)#flow-balance-group flow flow_huiyi 4---->The default value is 5%. The percentage baseline is 10 Mbps by default.
```

- 3) Add APs to the load balance group

```
Ruijie(config-ac)#flow-balance-group add flow_huiyi ap220-1
Ruijie(config-ac)#flow-balance-group add flow_huiyi ap220-2
```

IV. Verification

1. Number-based

- 1) Use "show ac-config num-balance summary" on AC to check load balance state.

```
Ruijie#show ac-config flow-balance summary
Group          State Enable      Threshold Base  mode          AP NAME
-----
flow_huiyi     UP      5*100kbps    4%      10  ap-mode(0)   ap220-1, ap220-2
```

- 2) Use "show ap-config summary" on AC, check the number of STAs on each AP

2. Traffic-based

- 1) Use "show ac-config num-balance summary" on AC to check load balance state.

```
Ruijie#show ac-config flow-balance summary
Group          State Enable      Threshold Base  mode          AP NAME
-----
flow_huiyi     UP      5*100kbps    4%      10  ap-mode(0)   ap220-1, ap220-2
```

5.11.1 FAQ

5.11.1.1 How to View the Flow Balancing Group

Run the **show ac-config flow-balance summary** command to display the flow balancing group.

```

show ac-config flow-balance summary
↵
Group          Threshold      AP NAME ↵
-----
name2          4*100kbps     ap1, ap2↵
↵

```

5.11.1.2 How to enable the flow-based load Balancing in local forwarding scenario?

In local forwarding mode, you can run the following command to enable flow balancing:

Ruijie(config-ac)#flow-balance-group radio-flow ?//Indicates the flow information of the flow balancing group reported by AP.

WORD Flow balance group name

Data packets in local forwarding mode do not pass through the AC and thus the AC cannot get the flow information. Load balancing must be judged by the traffic information reported by AP.

5.11.1.3 How many load balancing groups can an AC support now?

Up to 80 number-based balancing groups and 80 flow-based balancing groups.

5.11.1.4 How many APs at most can each load balancing group support?

10.

5.11.1.5 How to enable load balancing between AP radios on AC?

Under AP-config mode:

inter-radio-balance flow-balance enable //Based on flow

inter-radio-balance num-balance enable //Based on the number of users

You can configure the inter-radio load balancing parameters (optional) on AC based on actual requirements during network optimization.

Run the **inter-radio-balance flow-balance dual-band enable-load en-num threshold thrs-num** command to configure the enabling threshold of flow-based load balancing between radios of different bands. The lower the threshold, the easier the flow balancing can be enabled and the more even the flow is allocated.

Run the **inter-radio-balance flow-balance same-band enable-load en-num threshold thrs-num** command to configure the enabling threshold of flow-based load balancing between radios of same band. The lower the threshold, the easier the flow balancing can be enabled and the more even the flow is allocated.

Run the **inter-radio-balance num-balance dual-band enable-load en-num threshold thrs-num** command to configure the enabling threshold of number-based load balancing between radios of different bands. The lower the threshold, the easier the flow balancing can be enabled and the more even the flow is allocated.

Run the **inter-radio-balance num-balance same-band enable-load en-num threshold thrs-num** command to configure the enabling threshold of number-based load balancing between radios of same band. The lower the threshold, the easier the flow balancing can be enabled and the more even the flow is allocated.

5.12 RIPT

Overview

The Remote Intelligent Perceptive Technology (RIPT) is also known as the smart AP technology. As a wireless network edge device (as compared with an AC), the smart AP can perceive its connection with the AC and take over external provision of wireless networks seamlessly once connection fails. The wireless RIPT solution can be deployed in enterprise branch networks for the availability and sustainability of inter-WAN networks between the AC and APs in case of faults. It can also be deployed in a Wireless Local Area Network (WLAN) network to reduce reliance on ACs and improve its availability.

RIPT supports below two scenarios:

1. In 802.1x authentication scenario, we configure a escape-SSID in advance. The escape-SSID is hidden and disabled when the CAPWAP tunnel between AP and AC is operational. Once the AP is disconnected from AC, the escape-SSID is enabled to provide local resource access for STAs. When the tunnel recovers, the escape-SSID is disabled. When the 802.1X authentication is enabled and the RIPT AP works in standalone mode, the STAs cannot access the network through the 802.1X authentication.
2. In Web authentication scenario, once the AP is disconnected from AC, STAs can access the network without authentication. When the tunnel recovers, the Web or MAB authentication is required again. When the Web or MAB authentication is enabled and the RIPT AP works in standalone mode, the STAs cannot access the network through the Web or MAB authentication. In this case, you can enable the Web authentication exemption function to provide network access for STAs.

I. Network Topology

None

II. Configuration Steps

In 802.1x authentication scenario

1, make sure you have done 802.1x authentication settings right, you are able to access the SSID, pass the authentication, and visit Internet & Intranet with local forwarding.

To enable local forwarding mode, as below,

```
Ruijie(config)#wlan-config 5 "802.1x"
```

```
Ruijie(config-wlan)# tunnel local
```

2, configure RIPT as below steps:

1) Configure escape SSID

```
Ruijie(config)#wlan-config 10 "escape SSID"
Ruijie(config-wlan)#tunnel local
Ruijie(config-wlan)# enable-ssid at-capwap-down
```

2).Enable ript under AP group configuration mode

```
Ruijie(config)#ap-group default
Ruijie(config-group)#ript enable
```

In Web authentication scenario

1, make sure you have done web authentication settings right, you are able to access the SSID, pass the authentication, and visit Internet & Intranet with local forwarding.

To enable local forwarding mode, as below,

```
Ruijie(config)#wlan-config 15 "web authentication"
Ruijie(config-wlan)# tunnel local
```

2, configure RIPT as below steps:

1). Enable "free web authen" under wlan-config mode

```
Ruijie(config)#wlan-config 15 "web authentication"
Ruijie(config-wlan)# free-webauth at-capwap-down
```

2) Enable ript under AP group configuration mode

```
Ruijie(config)#ap-group default
Ruijie(config-group)#ript enable
```

III. Verification

1. To display RIPT status, execute command "show ap-config summary ript-enable"

```
Ruijie#show ap-config summary ript-enable
AP Name                IP Address      Mac Address      ript-enable State
-----
ap1                    172.18.55.73   1414.4b54.0000YY  Run
```

2. Simulate AC down by unplug network cable, power off (it is not applicable to administratorly shutdown port on AC).

a. To test 802.1x authentication ript scenario, connect SSID "escape SSID", without authentication, you are able to visit Internet & Intranet

b. To test web authentication ript scenario, connect SSID "web authentication", without authentication, you are able to

visit Internet & Intranet

Note: If AC is DHCP Server that assign IP address to wireless users, then wireless user will no longer obtain IP address once AC is down. Therefore, do not set DHCP server for wireless user on AC in RIPT scenario.

5.13 NAT

I. Network Topology

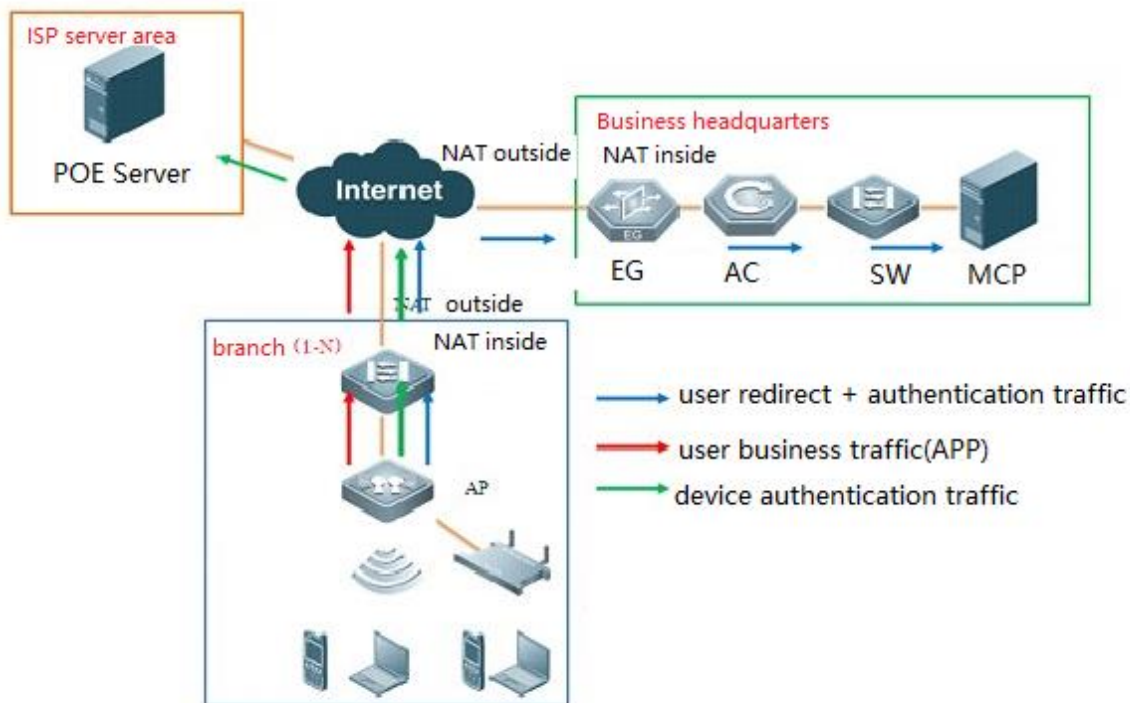

II. Configuration Steps

1. Configure DHCP pool for intranet users

```
Ruijie(config)#ip dhcp pool sta
Ruijie(dhcp-config)#network 192.168.1.0 255.255.255.0
Ruijie(dhcp-config)#dns-server 8.8.8.8
Ruijie(dhcp-config)#default-router 192.168.1.1
```

2. Configure ACL match intranet users' traffic

```
Ruijie(config)#ip access-list standard 1
Ruijie(config-std-nacl)#10 permit any
```

3. Configure IP address on the interface and set it as outside NAT interface

```
Ruijie(config)#interface GigabitEthernet 0/1
Ruijie(config-if-GigabitEthernet 0/1)# ip address 100.168.12.200 255.255.255.0
Ruijie(config-if-GigabitEthernet 0/1)#ip nat outside
```

4. Configure IP address on BVI interface 1 and set is as inside NAT interface

```
Ruijie(config)#interface BVI 1
Ruijie(config-if-BVI 1)#ip address 192.168.1.1 255.255.255.0
Ruijie(config-if-BVI 1)# ip nat inside
```

5. Configure address translation table

```
Ruijie(config)#ip nat inside source list 1 interface GigabitEthernet 0/1 overload
```

6. Configure default route pointing to gateway

```
Ruijie(config)#ip route 0.0.0.0 0.0.0.0 100.168.12.1
```

III. Verification

Intranet users are able to access the Internet.

5.14 URL Audit

I. Network Topology

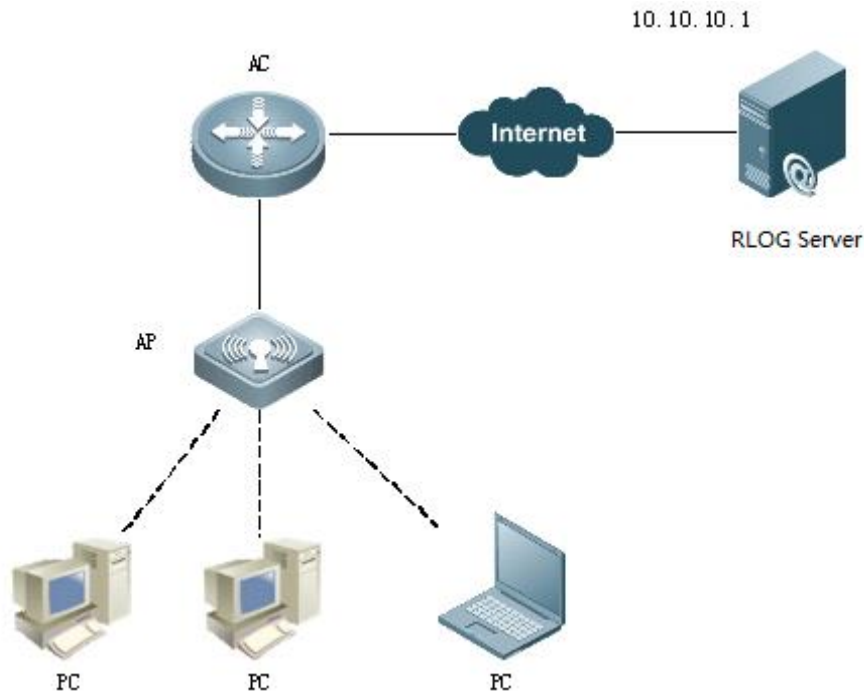

II. Configuration Steps

1. In manager forwarding mode, enable URL Auditing in global configuration mode

```
Ruijie# configure terminal
Ruijie(config)# url-rule audit-default-enable
Ruijie(config)# end
```

2. In local forwarding mode, enable URL Auditing in ap-config mode or ap-group mode

```
Ruijie# configure terminal
Ruijie(config)# ap-config all ----->configure all AP
Ruijie(config- ap)# url-rule audit-default-enable
Ruijie(config- ap)# end
```

III. Verification

Check the audited URL information using "show content-audit statistics brief" command.

In centralized forwarding mode, execute the command on AC. In local forwarding mode, execute the command on AP.

```
WS5708#show content-audit statistics brief
audit-total-number:22
id      relate-user  ap-name      audit-time   action  key-type
```

22	172.17.0.2	ap320-F4	2014-11-10 16:09:09	permit	url-host: blmobile.3g.qq.com	
21	172.17.0.2	ap320-F4	2014-11-10 16:09:08	permit	url-host: blmobile.3g.qq.com	
20	172.17.0.2	ap320-F4	2014-11-10 16:09:02	permit	url-host: m.baidu.com	
19	172.17.0.2	ap320-F4	2014-11-10 16:09:02	permit	url-host:	ucs1.zc.ucweb.com:8080
18	172.17.0.2	ap320-F4	2014-11-10 16:08:55	permit	url-host: cgi.connect.qq.com	
17	172.17.0.2	ap320-F4	2014-11-10 16:08:53	permit	url-host: appsupport.qq.com	

This table can only contain 50 records. Use "clear content-audit statistic" command to clear the current audit records.

5.15 PPSK

5.15.1 Overview

1. Private Pre-Shared Key (PPSK) authentication can be enabled on only one Wireless Local Area Network (WLAN).
2. One independent Wi-Fi key (8 characters) is generated for each user and can be used to connect only one terminal. When the first terminal logs in, the key is bound to the terminal's Media Access Control (MAC) address so that it can be used only on this terminal. Authentication fails if you enter this key on other terminals.
3. A maximum of 1,500 keys can be generated for one user.

5.15.2 Scenario

Employee Type	Number of Employees	Number of Keys Assigned to Each Account	Total
Local	121	3	363
Non-local	30	2	60

5.15.3 Implementation Steps

5.15.3.1 Upgrade

Upgrade the access controller (AC) and access point (AP) to the latest firmware version.

5.15.3.2 Enabling the PPSK

On the Web page, choose **Network > WiFi/WLAN**, select **WPA/WPA2-PSK**, and select **Enable PPSK**.

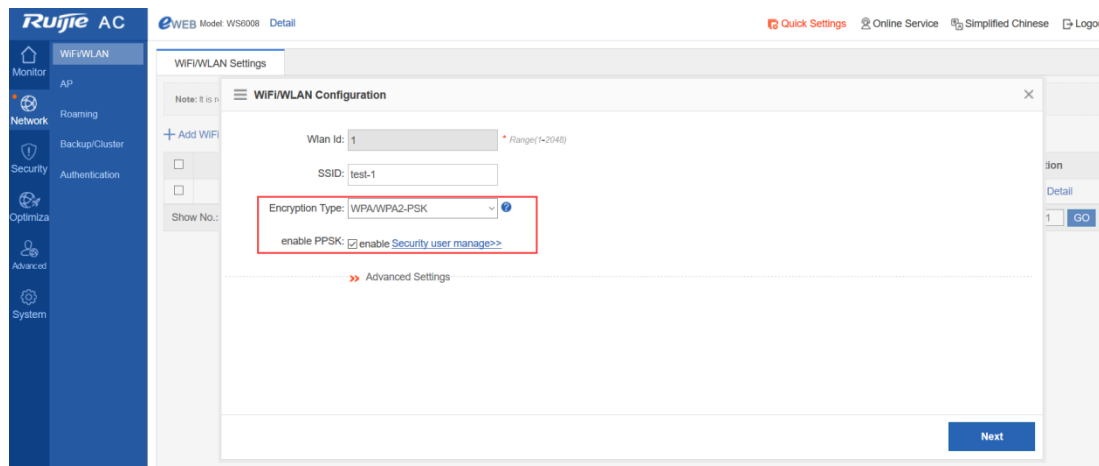

5.15.3.3 PPSK Account Management

On the Web page, choose **Security > Security user manage**. The following figure shows the effect of importing user names.

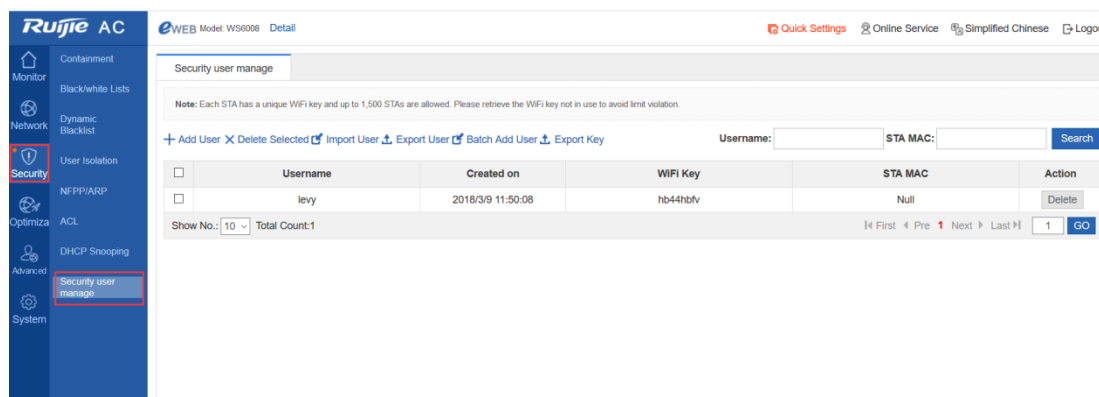

5.15.3.3.1 Adding a User

Click **Add User**. The following dialog box is displayed. Enter the user name. A random 8-character key is automatically generated.

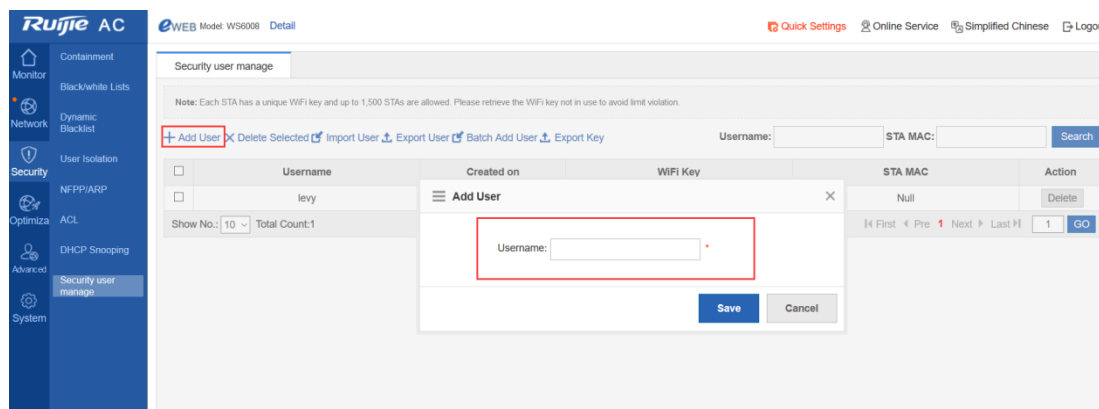

5.15.3.3.2 Adding Users in Batches

Click **Batch Add User**. The following dialog box is displayed. Download a template and enter user names.

The following figure shows a template for batch importing (**user_template**).

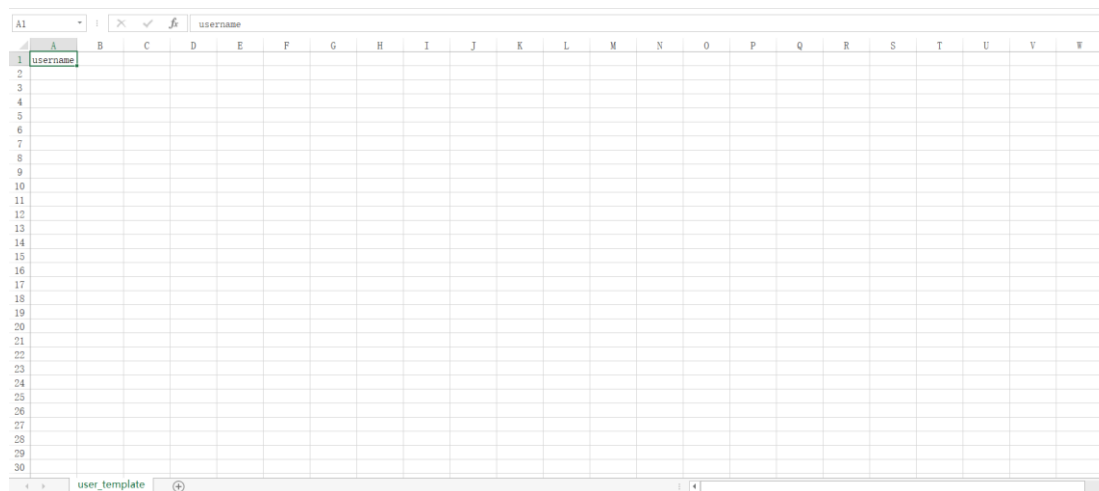

Note: User names are imported in the table from top to bottom. To display them in alphabetic order with identical user names next to each other, you need to rank them first because they cannot be ranked on the **Security user manage** page.

5.15.3.3.3 Exporting a Key

After user names are added or imported in batches, keys are automatically generated for all accounts. To export and assign the keys to all users, click **Export Key** to download the following table.

username	sta-mac	wifkey(non-encryption)
levy		hb44bfbv

5.15.3.3.4 Backing up Data

The difference between **Export User** and **Export Key** is that the keys exported are displayed in cyphertext mode if you click **Export User** but in plaintext mode if you click **Export Key**.

username	sta-mac	wifkey(encryption)
levy		043f1a526a0b2d130476z

5.15.3.3.5 Restoring Data

To restore data is to import backup data. Click **Import User**. The following dialog box is displayed.

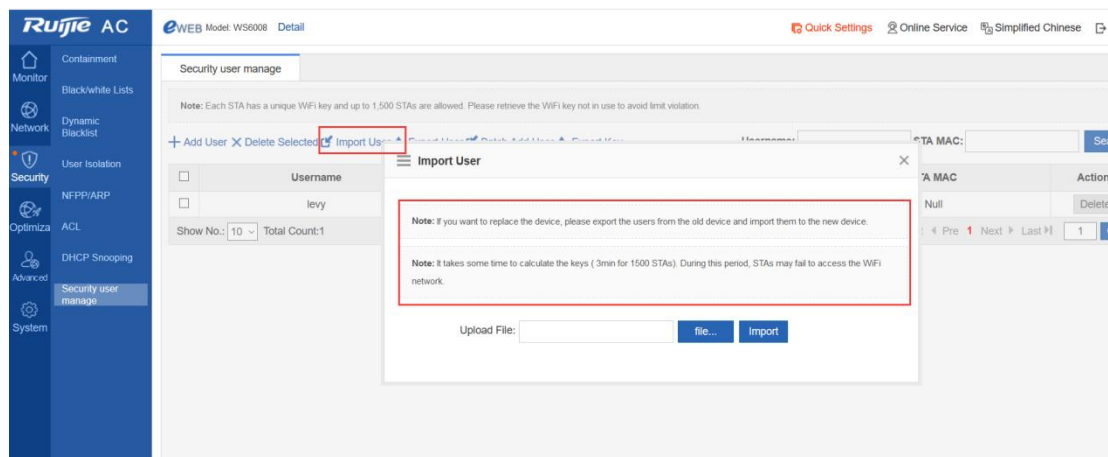

5.15.3.3.6 Searching an Account

If too many PPSK accounts are managed, you can find a user by entering the user name or MAC address.

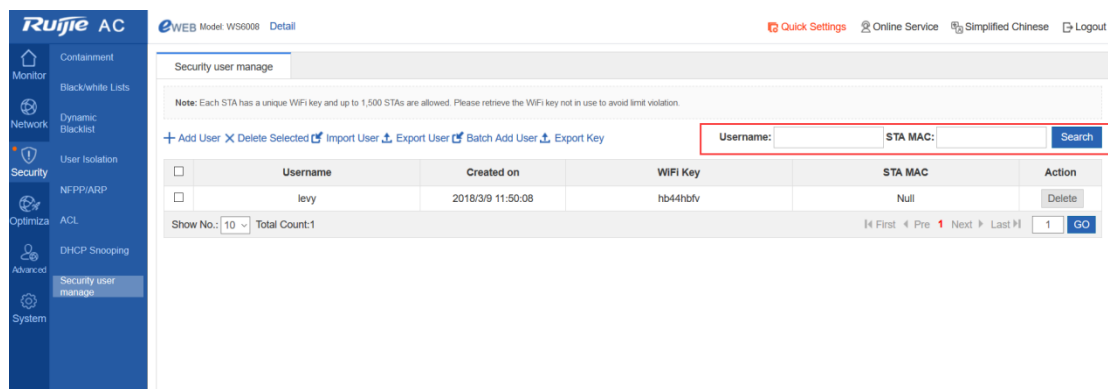

5.15.4 PPSK Configuration and Verification Under the Command Line

5.15.4.1 PPSK Configuration Under the Command Line

//Enter the user name. A PPSK is generated.

5.15.4.2 PPSK Verification Under the Command Line

Verify one PPSK account.

```
WS6008-1A#show sumng user name tiansiyang
-----
UserName      WifiKey      Account-Time  Mac-Address  Reg-Time
-----
[redacted]  [redacted]25  Thu Sep 14 14:53:32 2017  -            -
```

To check all PPSK accounts, display the number of current PPSK accounts and the number of accounts bound to MAC addresses.

```

WS6008-1A#show summg user all
Summg Total User Num: ..... 365
Summg Total Sta Num: ..... 53

```

UserName	WifiKey	Account-Time	Mac-Address	Reg-Time
tia...iyang	hh...c25	Thu Sep 14 14:53:32 2017	-	-
li...en	hh...c6	Thu Sep 14 10:06:51 2017	-	-
an...	h...63	Thu Sep 14 09:32:57 2017	-	-
an...	h...jc2	Thu Sep 14 09:32:57 2017	-	-
an...	h...jcq	Thu Sep 14 09:32:57 2017	-	-
ba...ng	hh...4cv	Thu Sep 14 09:32:57 2017	-	-
ba...ng	8h...c6x	Thu Sep 14 09:32:57 2017	-	-
ba...ng	4h...jbi	Thu Sep 14 09:32:57 2017	-	-
t...	jh...jbf	Thu Sep 14 09:32:57 2017	30...	Thu Sep 14 14:34:55 2017
ia...	6h...bt7	Thu Sep 14 09:32:57 2017	-	-
...	hh...bm5	Thu Sep 14 09:32:57 2017	acd...	Thu Sep 14 14:34:05 2017
...eng	hh...b86	Thu Sep 14 09:32:57 2017	-	-
...eng	hh...bz3	Thu Sep 14 09:32:57 2017	-	-
...eng	h...ib2	Thu Sep 14 09:32:57 2017	-	-
...feng	4...bq	Thu Sep 14 09:32:57 2017	-	-
...feng	h...ov	Thu Sep 14 09:32:57 2017	-	-
...feng	h...3bx	Thu Sep 14 09:32:57 2017	-	-
...iq	8h...i8i	Thu Sep 14 09:32:57 2017	-	-
...jq	h...6f	Thu Sep 14 09:32:57 2017	4c...	Thu Sep 14 10:01:49 2017
...jq	h...bd7	Thu Sep 14 09:32:57 2017	8f...	Thu Sep 14 10:01:02 2017

5.15.5 PPSK Verification

Create a user name **lishaohuan**. A random key **dhbs2666** is generated. Enter the key to connect the PC to the Wi-Fi network.



After PC authentication succeeds, the bound terminal MAC address displayed on the **Security user manage** page is the PC's MAC address.

Username	Created on	WiFi Key	STA MAC	Action
levy	2018/3/9 05:59:50	dhb46hpq	ec51.bc3b.4cc1	Delete
test1	2017/12/6 17:03:01	jhb4tppx	Null	Delete
test1	2017/12/6 17:03:00	hbb4n4ef	Null	Delete
test1	2017/12/6 17:03:00	hb84he67	Null	Delete
test1	2017/12/6 17:03:00	jhb42he5	Null	Delete
test1	2017/12/6 17:03:00	hb64he43	Null	Delete
test1	2017/12/6 17:03:00	4hb4hez2	Null	Delete

If you enter the same key on another terminal, authentication fails, as shown in the following figure.

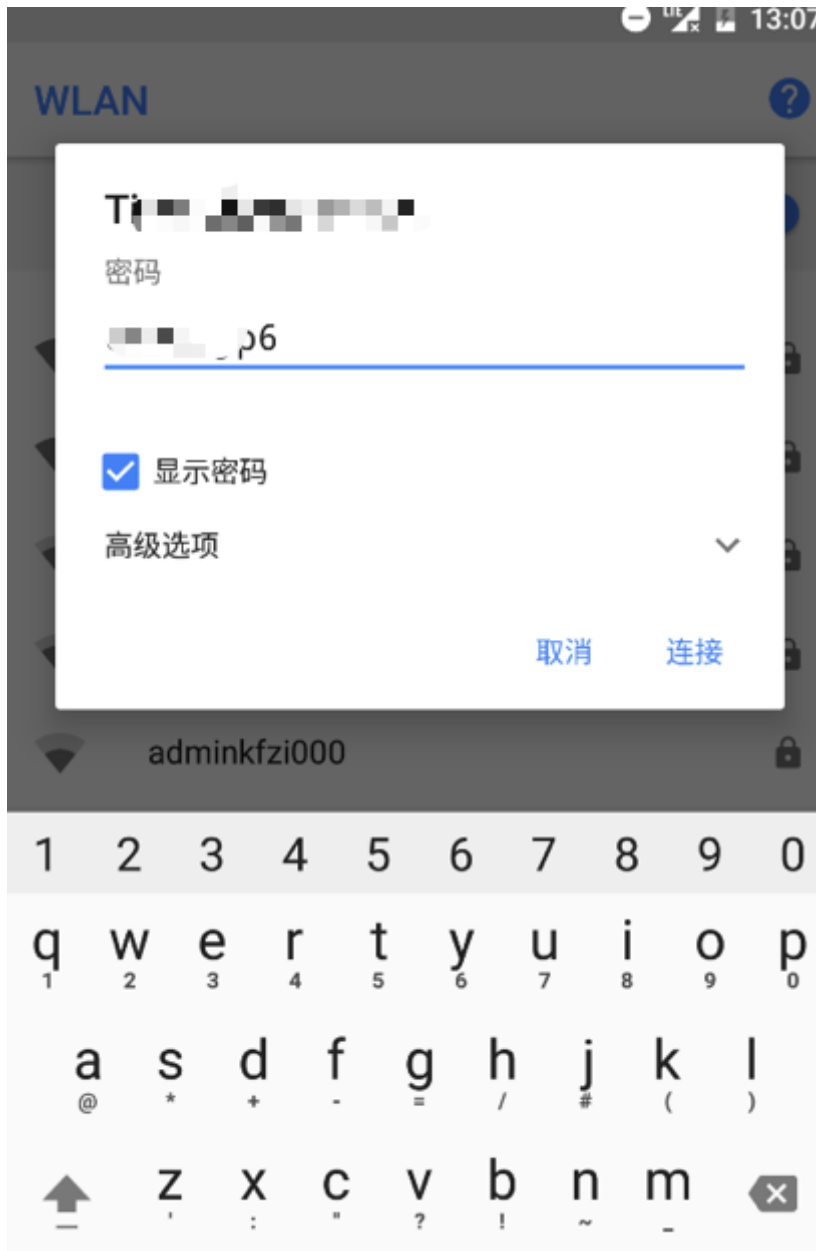



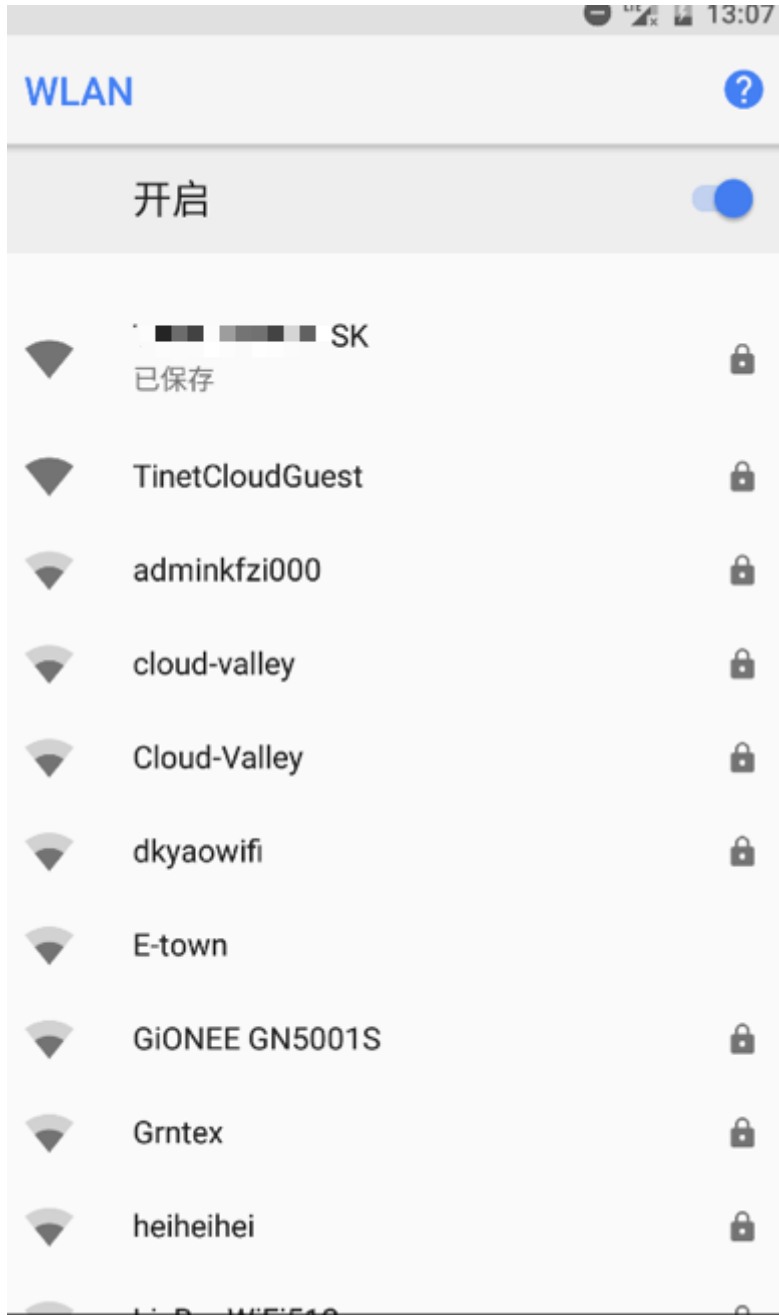

5.16 Bonjour Gateway

5.16.1 Overview

A Bonjour gateway manages clients and servers supporting Bonjour protocol to enable the application of Bonjour protocol to large-scale networks.

A Bonjour gateway has the following features.

Control the multicast DNS (mDNS) protocol packet traffic and reduce mDNS protocol packets on networks.

Support configuration of policies and manage services that can be used on clients.

Forward mDNS protocol packets of clients and servers across Virtual Local Area Networks (VLANs) and improve the usability of networks.

- The following describes the Bonjour gateway only.

Protocols and Standards

5.16.2 Applications

Application	Description
Query Proxy and Response Forwarding	<p>In some cases, if the Bonjour gateway fails to obtain specified services requested by clients according to the Bonjour service resource capacity although the gateway receives query packets from the clients, query proxy and response forwarding are enabled. The Bonjour gateway will forward query packets. If response packets relating to the services are received, the gateway will add corresponding information to the Bonjour service resource capacity and forward response packets to the clients. Then response pickup can be enabled.</p>

5.16.2.1 Query Proxy and Response Forwarding

Scenario

As shown in the following figure, iPad, Apple TV, and Print are on different VLANs. iPad needs to obtain IP addresses of Apple TV and Print through the Bonjour gateway to communicate with Apple TV and Print.

Figure 6-1 Bonjour gateway network topology

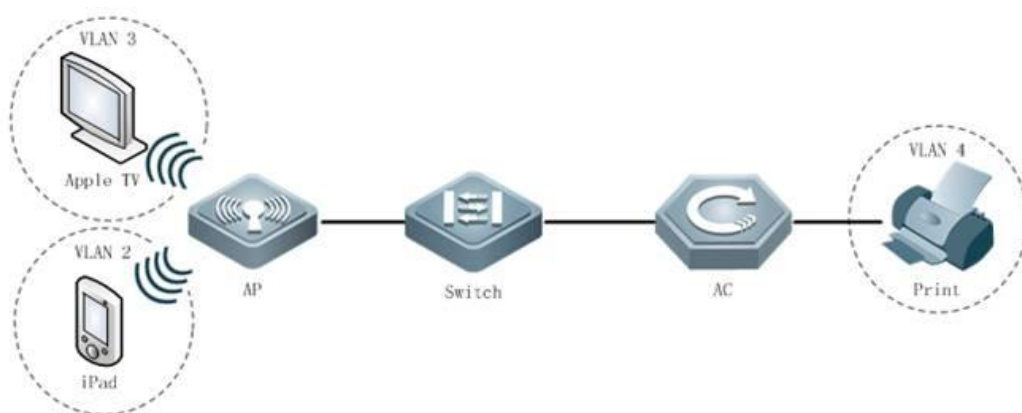

Deployment

A Bonjour gateway can process mDNS request packets received on the port only when the Bonjour gateway is enabled in global configuration mode.

5.16.2.2 Multimedia Gateway Disabling Preemption

Scenario

As shown in the following figure, iPad, Apple TV, and Print are on different VLANs. iPad needs to obtain IP addresses of Apple TV and Print through the Bonjour gateway to communicate with Apple TV and Print. Different terminals may use the screen projection feature of Apple TV simultaneously. In this case, preemption is enabled if the Bonjour gateway is disabled. However, preemption is disabled when the Bonjour gateway is enabled.

Figure 6-2 Bonjour gateway network topology

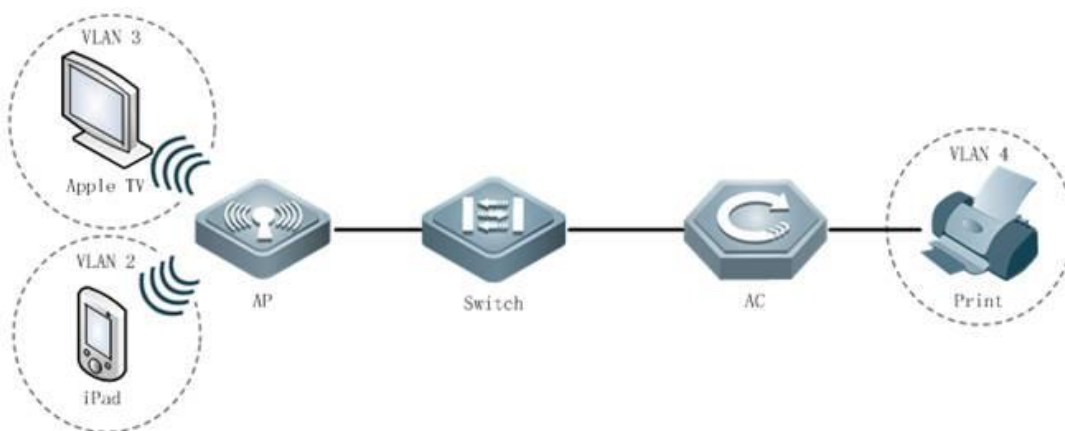

Deployment

A Bonjour gateway can process mDNS request packets received on the port and disable preemption only when the Bonjour gateway is enabled in global configuration mode. The preemption disabling feature is enabled forcibly and cannot be disabled.

5.16.2.3 Automatic Naming for the Multimedia Gateway Server

Scenario

As shown in the following figure, iPad, Apple TV, and Print are on different VLANs. iPad needs to obtain IP addresses of Apple TV and Print through the Bonjour gateway to communicate with Apple TV and Print. If multiple Apple TV devices exist on the network, they may share one name, which is confusing. Currently, devices can be automatically named in "name+IP address" mode to tell servers apart.

Figure 6-3 Bonjour gateway network topology

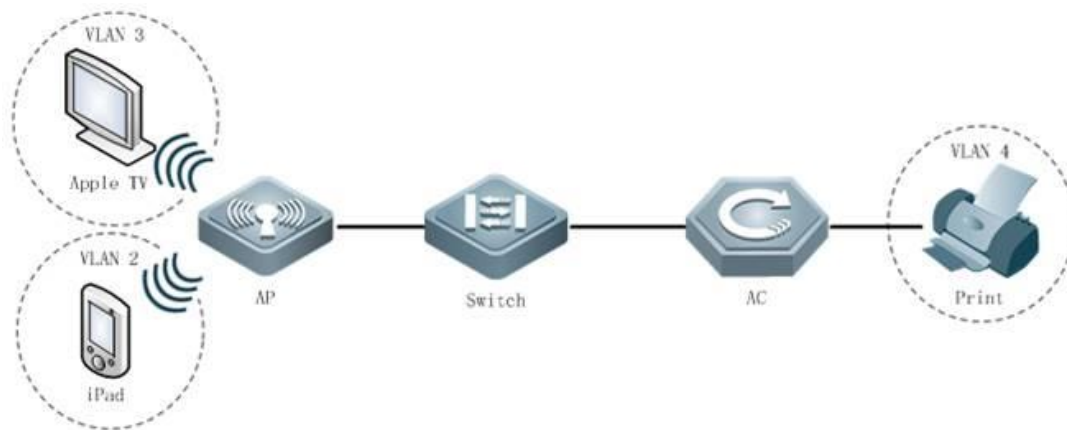

Deployment

A Bonjour gateway can process mDNS request packets received on the port and automatically name servers discovered only when the Bonjour gateway is enabled in global configuration mode.

5.16.3 Features

Basic Concepts

Bonjour

Apple names the mDNS-based open zero-configuration networking standards Bonjour. Devices using Bonjour automatically transmit their respective service information and listen to service information of other devices on networks, as if they were greeting each other. In this way, systems and service on Local Area Networks (LANs) can be detected easily without network administrators. Bonjour displays names of the devices and applications supporting mDNS protocol on LANs, and avoids device name repetition through mDNS.

Bonjour gateway

A Bonjour gateway manages clients and servers supporting Bonjour protocol to enable the application of Bonjour protocol to large-scale networks.

Overview

Feature	Description
---------	-------------

[Bonjour Gateway](#)

A Bonjour gateway manages clients and servers supporting Bonjour protocol to enable the application of Bonjour protocol to large-scale networks.

5.16.3.1 Bonjour Gateway

Working Principle

A Bonjour gateway manages clients and servers supporting Bonjour protocol to enable the application of Bonjour protocol to large-scale networks.

A Bonjour gateway has the following features.

Response pickup

On the network, servers send Bonjour response packets and notify supported services. Upon receipt of the response packets, the Bonjour gateway establishes a service resource capacity so that it can return response packets to the clients querying services in the capacity.

Query proxy and response forwarding

In some cases, if the Bonjour gateway fails to obtain specified services requested by clients according to the Bonjour service resource capacity although the gateway receives query packets from the clients, query proxy and response forwarding are enabled. The Bonjour gateway will forward query packets. If response packets relating to the services are received, the gateway will add corresponding information to the Bonjour service resource capacity and forward response packets to the clients. Then response pickup can be enabled.

Disabling screen preemption

Different terminals may use the screen projection feature of Apple TV simultaneously. In this case, preemption is enabled if the Bonjour gateway is disabled. However, preemption is disabled when the Bonjour gateway is enabled.

Automatic naming for servers

If multiple Apple TV devices exist on a network, they may share one name, which is confusing. Currently, devices can be automatically named in "name+IP address" mode to tell servers apart.

5.16.4 Configuration

Configuration	Description and Command	
Enabling the Bonjour Gateway	▲(Mandatory) It is used to establish Bonjour gateway services.	
	bonjour-gateway enable	Enables the Bonjour gateway.
	▲(Optional)	
Configuring Bonjour Policies	bonjour-gateway multicast	Configures the threshold for returning response packets in multicast mode.
	▲(Optional)	
	bonjour-gateway global-strategy	Applies specified Bonjour policies in global configuration mode.
	bonjour-gateway strategy	Applies specified Bonjour policies in interface configuration mode.

Configuration	Description and Command	
	bonjour-gateway strategy-mode	Creates Bonjour policies.
	service -type	Configures service rules.
	service- vlan	Configures VLANs on which query and response packets can be forwarded.
	service wired/wireless	Configures wired/wireless discovery.
Automatic Bonjour Service Query	▲(Optional)	
	bonjour-gateway query enable	Configures automatic Bonjour service query.
	bonjour-gateway query interval	Configures the interval for automatic Bonjour service query.

5.16.4.1 Enabling the Bonjour Gateway

Configuration Effect

Enable the Bonjour gateway so that Bonjour protocol can be applied to large-scale networks.

Notes

The Bonjour gateway must be enabled on a Layer-3 interface.

Configuration Steps

Enable the Bonjour gateway.

Mandatory.

Command	bonjour-gateway enable
Parameter Description	-
Defaults	The Bonjour gateway is disabled.
Command Mode	Global configuration mode or interface configuration mode
Usage Guide	The multicast mode is enabled on all or specified Layer-3 interfaces so that multicast packets can be forwarded.

Configuring the Threshold for Returning Response Packets in Multicast Mode

Optional.

Run the **bonjour-gateway multicast** command to configure the threshold for returning response packets in multicast mode.

Command	bonjour-gateway multicast <i>number</i>
Parameter Description	<i>number</i> : Indicates the threshold for returning response packets in multicast mode, ranging from 1 to 64.
Defaults	The threshold for returning response packets in multicast mode is 10.
Command Mode	Global configuration mode

Usage Guide	Run the bonjour-gateway multicast command to configure the threshold for returning response packets in multicast mode. Run the no bonjour-gateway multicast command to restore the default. By default, the threshold for returning response packets in multicast mode is 10.
--------------------	---

I

Verification

Run the **show run** command to check configurations for the Bonjour gateway.

Configuration Example

Enabling the Bonjour Gateway

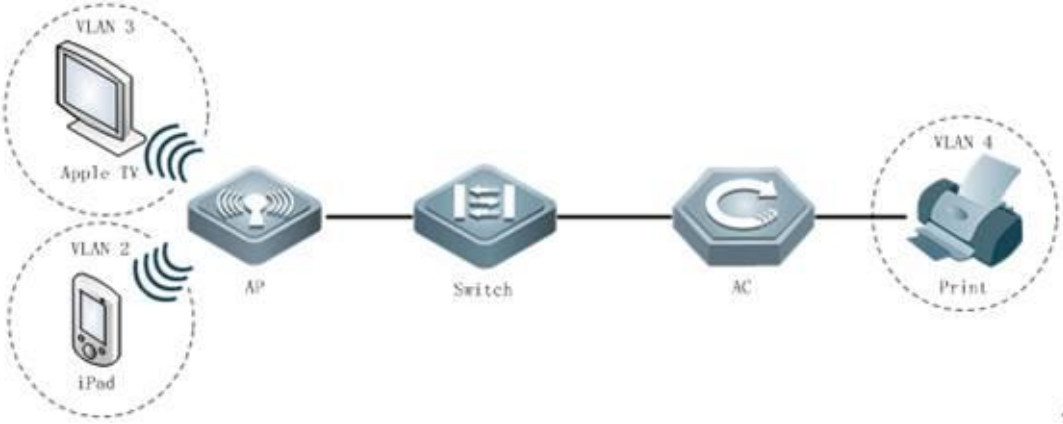
Scenario Figure 6-4	iPad, Apple TV, and Print are on different VLANs. iPad needs to obtain IP addresses of Apple TV and Print through the Bonjour gateway to communicate with Apple TV and Print.
	
Configuration Steps	Enable the Bonjour gateway.
Verification	Check whether the Bonjour gateway is enabled. !

Common Errors

-

5.16.4.2 Configuring Bonjour Policies

Configuration Effect

Support configuration of Bonjour policies and manage services that can be used on clients.

Notes

N/A

Configuration Steps

Create a Bonjour policy.

Optional.

Run the **bonjour-gateway strategy-mode** command to create a Bonjour policy.

Command	bonjour-gateway strategy-mode <i>name</i>
Parameter Description	<i>name</i> : Indicates the Bonjour policy name.
Defaults	No Bonjour policies exist.
Command Mode	Global configuration mode
Usage Guide	Run the bonjour-gateway strategy-mode command to create a Bonjour policy. Run the no bonjour-gateway strategy-mode command to delete a Bonjour policy. By default, no Bonjour policies exist. A maximum of 1,000 Bonjour policies can be created on a device.

Configuring Service Discovery Rules

Optional.

Run the **service-type wired/wireless disable** command to configure service discovery rules.

Command	service- [type <i>typewired</i> <i>wireless</i>] [ip <i>ipv4-address</i> ipv6 <i>ipv6-address</i> instance <i>name</i>]disable
Parameter Description	<i>type</i> : Indicates the service type. <i>ipv4-address</i> : Indicates the IPv4 address of the service. <i>ipv6-address</i> : Indicates the IPv6 address of the service. <i>name</i> : Indicates the instance name of the service.
Defaults	No limit is set for service searching; that is, a client can find all services in both wired and wireless modes.
Command Mode	bonjour-gateway configuration mode
Usage Guide	Run the service-type wired/wireless disable command to configure service rules. Run the no service-type wired/wireless disable command to delete service rules. By default, no limit is set for service searching; that is, a client can find all services in both wired and wireless modes.

Configuring Service Rules

Optional.

Run the **service type** command to configure service rules.

Command	service type <i>type</i> [ip <i>ipv4-address</i> instance <i>name</i> disable]
Parameter Description	<i>type</i> : Indicates the service type. <i>ipv4-address</i> : Indicates the IPv4 address of the service. <i>name</i> : Indicates the service instance name.
Defaults	No limit is set for service searching; that is, a client can find all services.
Command Mode	bonjour-gateway configuration mode
Usage Guide	Run the service type command to configure service rules. Run the noservice type command to delete service rules. By default, no limit is set for service searching; that is, a client can find all services. When the disable command is executed, services cannot be found.

Configuring Service VLANs

Optional.

Run the **service-vlan** command to configure VLANs on which query and response packets can be forwarded. Apply specified Bonjour policies.

Command	service- vlan <i>vlan-id-list</i> [access-vlan]
Parameter Description	<i>vlan-id-list</i> : Indicates the VLAN list. <i>access-vlan</i> : Forwards query and response packets on VLANs.
Defaults	No query or response packets are forwarded.
Command Mode	bonjour-gateway configuration mode
Usage Guide	Run the service- vlan command to configure VLANs on which query and response packets can be forwarded. Run the no service- vlan command to delete configurations. By default, no query or response packets are forwarded.

I

Applying Specified Bonjour Policies in Global Configuration Mode

Optional.

Run the **bonjour-gateway global-strategy** command to apply specified Bonjour policies on Layer-3 interfaces.

Command	bonjour-gateway global-strategy <i>name</i>
Parameter Description	<i>name</i> : Indicates the Bonjour policy name.
Defaults	No Bonjour policies are applied in global configuration mode.
Command Mode	Configuration mode
Usage Guide	Run the bonjour-gateway global-strategy command to apply specified Bonjour policies in global configuration mode. Run the no bonjour-gateway global-strategy command to cancel Bonjour policies in global configuration mode. By default, no Bonjour policies are applied in global configuration mode; that is, when the Bonjour gateway is enabled, only default service types are supported and can be discovered in both wired and wireless modes.

Applying Specified Bonjour Policies

Optional.

Run the **bonjour-gateway strategy** command to apply specified Bonjour policies on Layer-3 interfaces.

Command	bonjour-gateway strategy <i>name</i>
Parameter Description	<i>name</i> : Indicates the Bonjour policy name.
Defaults	No Bonjour policies are applied on Layer-3 interfaces.
Command Mode	Interface configuration mode
Usage Guide	Run the bonjour-gateway strategy command to apply specified Bonjour policies on Layer-3 interfaces. Run the no bonjour-gateway strategy command to cancel Bonjour policies. By default, no Bonjour policies are applied on Layer-3 interfaces.

I

Verification

Run the **show run** command to check configurations for the Bonjour gateway.

Configuration Example

Configuring Bonjour Policies

Scenario	See Figure 6-4.
Configuration Steps	Configure Bonjour policies.
Verification	<p>Check whether the Bonjour gateway is enabled.</p> <p>!</p> <p>Check whether Bonjour policies are configured.</p> <p>!</p>

Common Errors

N/A

5.16.4.3 Automatic Bonjour Service Query

Configuration Effect

To enable response pickup, maintain the Bonjour service resource capacity. Enable automatic Bonjour service query to ensure the real-time performance of the Bonjour service resource capacity.

Notes

N/A

Configuration Steps

Configuring Automatic Bonjour Service Query

Optional.

Run the **bonjour-gateway query enable** command to configure automatic Bonjour service query.

Command	bonjour-gateway query enable
Parameter Description	N/A
Defaults	The automatic Bonjour service query feature is disabled.
Command Mode	Global configuration mode
Usage Guide	Run the bonjour-gateway query enable command to configure automatic Bonjour service query. Run the no bonjour-gateway query enable command to disable automatic Bonjour service query. By default, The automatic Bonjour service query feature is disabled.

Configuring the Interval for Sending Query Packets to Discovered Services

Optional.

Configure the interval for sending query packets to discovered services.

Command	
Parameter	<i>number</i> : Indicates the interval for sending query packets to discovered services, ranging from 5 to 600 seconds.
Description	
Defaults	The interval for sending query packets to discovered services is 15 seconds.
Command Mode	Global configuration mode
Usage Guide	Run the bonjour-gateway query interval command to configure the interval for sending query packets to discovered services. Run the no bonjour-gateway query interval command to store the default. By default, the interval for sending query packets to discovered services is 15 seconds.

I

Verification

Run the **show run** command to check configurations for the Bonjour gateway.

Configuration Example

Configuring Automatic Bonjour Service Query

Scenario	See Figure 6-4.
Configuration Steps	Configure automatic Bonjour service query.
Verification	Check whether automatic Bonjour service query is configured. !

Common Errors

-

5.16.5 Monitoring

Description	Command
Displays discovered Bonjour services.	show bonjour-gateway service-database
Displays Bonjour statistics.	show bonjour-gateway statistics
Displays Bonjour policies.	show bonjour-gateway strategy-mode

Debugging

 System resources are occupied when debugging information is output. Therefore, disable debugging immediately after use.

Description	Command
Debugs the Bonjour gateway errors.	debug bonjour error
Debugs screen preemption for the Bonjour gateway.	debug bonjour stamng

5.17 Hierarchical AC

5.17.1 Overview

5.17.1.1 Background

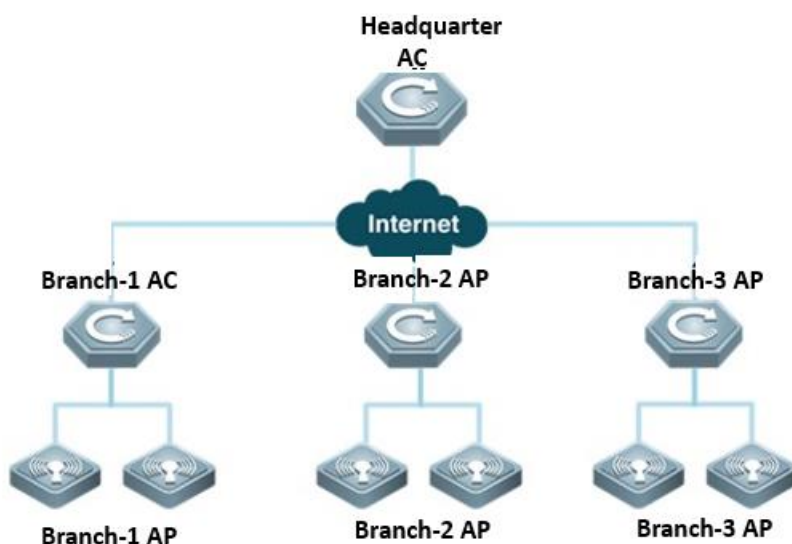

Hierarchical access controllers (ACs) provide a centralized management+distributed forwarding model (centralized control or distributed control is enabled on the control plane). As shown in the preceding figure, one headquarters AC and multiple branch ACs exist on the network. Normally a Wide Area Network (WAN), for example, the Internet, exists between the headquarters AC and branch ACs.

Headquarters AC: Access Point (AP) and AC versions and configurations can be assigned by the headquarters AC in centralized mode. The status of wireless APs and clients on the entire network can be displayed on the headquarters AC in centralized mode. Normally, branch ACs manage branch APs and stations (STAs). When branch ACs become abnormal, the headquarters AC takes over the job temporarily.

Branch AC: A branch AC is composed of standard ACs, all-in-one ACs (capable of routing and Deep Packet Inspection (DPI)), or wired/wireless integrated switches. Normally, branch ACs manage branch APs and stations (STAs). When branch ACs become abnormal, the headquarters AC takes over the job temporarily so that the network reliability can be improved.

In the following two scenarios, hierarchical ACs are needed.

Scenario 1: General education MetropolitanAreaNetwork (MAN): High-performance ACs are deployed for the Education Bureau, and small ACs (standalones) are deployed for middle and primary schools. The following describes requirements in the scenario.

High reliability

When branch ACs of middle and primary schools fail, branch APs can be connected to the center AC of the Education Bureau to ensure the availability of wireless networks..

Easy management

Supporting unified upgrade: The center AC supports unified upgrade of branch ACs and APs. Multiple models of branch ACs and APs can exist.

Supporting unified authorization: Branch ACs of middle and primary schools and the center AC of the Education Bureau share one AP license so that no more licenses are needed.

Supporting unified configuration as well as hierarchical and rights-based management: As the Education Bureau manages schools in mandatory mode, it must be able to manage devices (ACs and APs) on the entire network in unified mode. However, in view of the heavy management workload, management rights can be delegated to schools for hierarchical and rights-based management. As only a few teachers in the general education system are well informationalized, if the management rights are completely delegated, schools cannot manage themselves well.

Supporting unified monitoring: You can check which branch ACs, APs, or terminals are online.

Supporting unified authentication: Authentication servers are deployed in the Education Bureau, and accounts are managed by these servers in centralized mode. Branch devices must be authenticated in the headquarters before they are connected to the network.

Supporting distributed authentication: Red-Giant Easy Security System (RG-ESS) is deployed in branches, and Red-Giant Identity & Policy Center (RG-IPC) is deployed in the headquarters. The mature solutions for distributed ESS+IPC deployment are supported.

Note: The user traffic is forwarded from the local Internet egress of a branch.

Scenario 2: Headquarters-branch wireless office network: High-performance ACs are deployed for the headquarters, and small ACs (standalones) are deployed for branches. The following describes requirements in the scenario.

Easy management

Supporting unified upgrade: See "Scenario 1".

Supporting unified authorization: See "Scenario 1".

Supporting unified configuration as well as hierarchical and rights-based management: Branches must apply specific configurations applied by the headquarters. For example, if ruijie-web signals must be released, branch devices are allowed to release other ruijie-xxx signals.

Supporting unified monitoring: You can check branch AC connections on the center AC and check connections between APs and STAs on branch ACs.

Supporting unified authentication: The headquarters manages in mandatory mode the wireless connection of branch devices. Accounts are managed by headquarters-authenticated servers in centralized mode. Branch devices must be authenticated in

the headquarters before they are connected to the network. After authentication succeeds, the traffic is forwarded from the local Internet egress of the branch.

Supporting distributed authentication: RG-ESS is deployed in branches, and RG-IPC is deployed in the headquarters. The mature solutions for distributed ESS+IPC deployment are supported.

Note: The user traffic is forwarded from the local Internet egress of a branch.

Note: 1. The current release does not support unified configuration.

2. Currently, in the scenario of hierarchical AC deployment, neither ACs in the headquarters nor ACs in branches support virtual AC (vAC) deployment.

5.17.1.2 Components and Version

Area	Product Name	Function	Version	Remarks
Branch	Wireless AP	Wireless forwarding path	Later than V11.x B8	N/A
	Power over Ethernet (PoE) switch	PoE	Unlimited	N/A
	Wireless AC	Box wireless AP controller	Office networks	Supported by specific versions and models
	Easy Gateway (EG)	Gateway, Virtual Private Network (VPN), traffic control, and network address translation (NAT)	Unlimited	N/A
	Eportal	Portal server	Unlimited	Required for distributed authentication only
	RG-ESS	ESS	Unlimited	Required for distributed authentication only
Headquarters	Wireless AP	Wireless forwarding path	Later than V11.x B8	N/A
	PoE switch	PoE	Unlimited	N/A
	Wireless AC	Box wireless AP controller or board-style (N18K) wireless AP controller	Office networks	Supported by specific versions and models
	Gateway switch	Gateway	Unlimited	N/A
	EG	Gateway, VPN, traffic control, and NAT	Unlimited	N/A
	Eportal	Portal server	Unlimited	N/A
	SAM	AAA server	Unlimited	N/A
	RG-IPC	IPC: RG-IPC is a control center of Red-Giant Security Management	Unlimited	Required for distributed authentication only

		Platform (RG-SMP) and RG-ESS in distributed management mode. As a management center deployed in the management organization of the headquarters, RG-IPC manages RG-SMP and RG-ESS servers running in distributed management mode. It is capable of branch management and unified user management.		
--	--	---	--	--

5.17.2 Preparation for Deployment

5.17.2.1 Device Selection

During deployment of hierarchical AC networks, a center AC bears unified upgrade, unified monitoring, and failure backup, which requires strong processing capabilities of the headquarters AC. Currently, the following models can serve as center ACs.

WS6816

WS6812

M8600E-WS-ED

M18000-WS-ED

The following models can serve as branch ACs. Low-end and mid-range models (including WS5708, WS6108, WS6008, WS6024, and M6000-WS) are adequate; high-end models (including WS6816, WS6812, M8600E-WS-ED, and M18000-WS-ED) are not required.

I WS5708

I WS6108

I WS6008

I WS6024

I M6000-WS

I WS6816

I WS6812

I M8600E-WS-ED

I M18000-WS-ED

How many branch ACs the network supports is determined by the following two conditions (for example, theoretically 128 branch ACs are supported in cold backup mode). If a center AC can manage a maximum of 4,000 APs and each branch AC has 1,000 APs, four branch ACs are supported. That is, only four branch ACs can be supported.

In cold backup mode, a maximum of 128 branch ACs are supported. In hot backup mode, a maximum of 32 branch ACs are supported. In hybrid mode, the value of "the number of hot backup branch ACs x 4 + the number of cold backup branch ACs" must be less than 128; therefore, the number of branch ACs supported is between 32 and 128.

The maximum number of APs to be managed by a center AC (the number of branch ACs + the number of all APs and STAs in the headquarters) or branch AC (the number of branch APs and STAs), the maximum number of APs to be configured, the maximum number of STAs to be managed, and the recommended number of STAs to be managed equal the maximum numbers of devices to be supported by corresponding products, respectively. For example, if the center AC is ws6812, as the maximum number of APs to be configured on ws6812 is 8,000, the maximum number of APs to be configured on the center AC is 8,000.

Note: The following describes the difference between cold and hot backup modes.

In hot backup mode, theoretically online users are completely unaware of failover because of uninterrupted data flows. New users can be authenticated and go online only after the failover, which lasts for 30 seconds.

In cold backup mode, online users are almost unaware of failover (theoretically, data flows are interrupted for no more than 30 seconds). New users can be authenticated and go online only after the failover, which lasts for 30 seconds.

In cold backup mode, a CAPWAP tunnel is built between each branch AP and each branch AC and between each branch AP and the center AC, respectively. However, between branch ACs and the center AC, only the data required for unified monitoring are backed up, and user entries are not backed up. When failover occurs, STAs need to be associated, apply for IP addresses, and be authenticated again. STAs like mobile phones automatically get associated and apply for IP addresses, which users are almost unaware of. STAs also automatically finish dot1x authentication or perception-free authentication, which users are almost unaware of. For non-perception-free Web authentication (which does not exist in reality), the authentication page is displayed again, and users need to enter the user name and password.

5.17.2.2 User IP Address Planning

In the following two scenarios, user IP address segments of center and branch ACs need to be planned.

Wireless access authentication servers of branch ACs are deployed on the center AC and used for portal authentication. In this case, as portal authentication is based on IP addresses, there are requirements for IP addresses in deployment.

Despite independent wireless access authentication servers deployed on branch ACs, data of branch and center ACs are backed up, and portal authentication is used for wireless access. In this case, when branch ACs fail, the center AC takes over wireless access authentication for branch ACs so that there are requirements for IP addresses in deployment.

In the preceding two scenarios, IP address segments of branch and center ACs need to be planned provided that IP address **segments of branch and center ACs must not be overlapped.**

5.17.2.3 License Planning

One of the advantages of deploying hierarchical ACs is that branch and center ACs can share the same licenses. When branch ACs fail, the center AC takes over the APs of branch ACs, in extreme cases, the total of center APs plus branch APs is the number of APs necessary for deploying hierarchical ACs. Therefore, you need to consider the demands of center and branch APs when purchasing AP licenses.

Licenses (including the default ones) of branch ACs are automatically synchronized to the headquarters AC. They are frozen for the branch ACs and will be unfrozen only when the branch ACs become abnormal and the headquarters AC needs to take over APs. However, the right of license use is reserved only for 7-14 days by default. Therefore, branch ACs must recover within 7-14 days; otherwise, branch APs have to occupy the licenses of the headquarters AC.

Licenses of a branch AC cannot be shared with other branch ACs, while licenses (including the default ones) of the center AC can be shared with branch ACs. When the center AC is disconnected, hierarchical ACs no longer exist and branch ACs become independent of each other (the right to use licenses of the center AC is also reserved only for 7-14 days by default). Therefore, AP licenses can be installed on the center AC, which will share the licenses with branch ACs.

5.17.2.4 Remote Interconnection Planning

For deployment of center ACs, the center AC must be able to remotely interconnect with each branch AC. The following solutions are available for remote interconnection.

Dedicated line: The center AC is connected with branch ACs through dedicated lines. In this case, the center AC and branch ACs form a large Local Area Network (LAN) where the center AC already interworks with branch ACs so that no special deployment is needed.

VPN: For example, a VPN is established between branch egress routers and the center egress router through Internet Protocol Security (IPSec); routes are configured so that data of LAN segments can be communicated through the VPN.

Mapping LAN addresses to WANs through NAT for interworking between branches and the headquarters: Mapping some LAN addresses to WANs through NAT is not allowed for office networks because it is not safe. In addition, currently all egress devices support IPSec VPN. Therefore, such deployment mode is not recommended.

5.17.2.5 Authentication Planning

Deployment authentication is one of the foundations for deployment of wireless networks. In hierarchical AC networking, two elements should be considered for deployment authentication.

Type of Wireless Access Authentication

Typical wireless access authentication includes WAP2-PSK, WPA2-802.1X, and Portal authentication.

WAP2-PSK: There are no special restrictions on deployment.

WAP2-802.1X: There are no special restrictions on deployment. To deploy the ip-valid feature of 802.1X, see "Section 2.2 User IP Address Planning". During the network planning, IP address segments of headquarters and branch ACs must not be overlapped.

Portal authentication: See "Section 2.2 User IP Address Planning". During the network planning, IP address segments of headquarters and branch ACs must not be overlapped.

Positions of Branch Authentication Servers

Two deployment models are available.

Deploying independent authentication servers in branches: In this model, branch ACs independently maintain authentication servers and accounts. In addition, accounts need to be synchronized between the center AC and branch ACs so that when

branch ACs fail, the center AC can take over network access authentication servers. Accounts can be synchronized in two modes.

Manual synchronization

Deploy an AD domain on the authentication server as a database for authenticated accounts, and synchronize accounts through the AD domain. For details, see the Windows AD Domain Configuration Guide.

Deploy Ruijie IPC to synchronize accounts of the branch authentication servers (ESS) with accounts of the center authentication server (SMP). For details, see the ESS/IPC Configuration Guide.

Branch ACs using the center authentication servers: As authentication will affect wireless network access, this deployment mode is demanding on the reliability of links between branch ACs and the center AC. If branch ACs are not connected to the center AC through highly reliable links, such as dedicated lines or MANs, such deployment mode cannot be used. However, the following requirements must be met if you are determined to use the deployment mode.

Performance of the center authentication server: Performance of software and hardware should be considered. When a baseline is applied, the authentication server must be able to support online authentication for users of the center AC and all branch ACs. For details, see software and hardware specifications of the authentication server.

Reliability of servers: Servers must be highly reliable because they authenticate center and branch devices on networks. Uninterruptible Power Supply (UPS), server load balancing, and multi-server backup should be considered beforehand.

Account management: In this model, center devices maintain accounts of all branch devices, including avoiding account overlapping and changing.

5.17.2.6 WLAN Planning

One of the advantages of deploying hierarchical ACs is that when branch ACs fail, the center AC can take over branches and continues offering wireless network access services. For that purpose, wireless networks need to be planned for center and branch ACs.

High liability of the center AC: As the center AC needs to take over wireless networks for branch ACs when they fail, the center AC must be highly reliable.

Unified WLAN planning: Hierarchical ACs back up data of center and branch devices by using the backup technology to enable failover. Therefore, WLANs need to be planned for center and branch devices as if during hot backup deployment: AP groups, WLAN IDs, and Service Set Identifiers (SSIDs) must be consistent. This operation is reflected in hot backup configuration; that is, hot backup configuration for the center AC must be consistent with that for branch ACs. In this way, when branch ACs fail, the center AC can take over branches with the same configuration.

5.17.2.7 Bandwidth Consumption by Hierarchical ACs

The bandwidth consumed by hierarchical ACs is mainly used to back up user entries between branches and the headquarters.

Consumption of branch egress bandwidth: A branch AC authenticates no more than 32 online/offline users per second (for example, based on the specifications, the index of WS5708 authenticating online/offline users per second is 32/second).

In cold backup mode, each branch AC backs up one user and sends only one packet. As 32 packets are sent per second and the size of each packet is no more than 0.5 KB, no more than 16 KB of packets are sent per second.

In hot backup mode, each branch AC backs up one user and sends four packets. Therefore, no more than 64 KB of packets are sent per second.

Consumption of headquarters egress bandwidth:

In cold backup mode, as a maximum of 128 branch ACs are supported, no more than 2 MB (128 x 16 KB/second = 2 MB/second) of packets are sent per second.

In hot backup mode, as a maximum of 32 branch ACs are supported, no more than 2 MB (32 x 64KB/second = 2 MB/second) of packets are sent per second.

Note: Hierarchical ACs back up user entries through Transmission Control Protocol (TCP) (packets will be retransmitted automatically in case of packet loss). Default traffic control solutions of Ruijie EG and other egress devices ensure office applications first in case of insufficient bandwidth. Even if some user entries fail to be backed up, users only need to go online again after failover without being seriously affected.

5.17.3 Deployment Guide

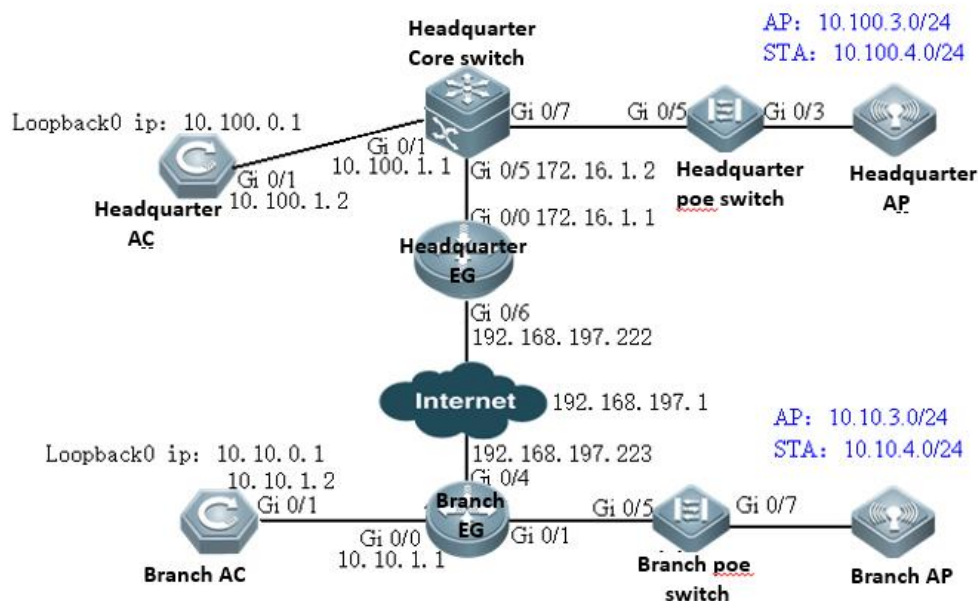

The following uses the preceding figure to describe solution deployment (deployment relating to authentication will be described specifically later).

Headquarters

As a network egress, EG is connected to networks through a static IP address. The gateway for LAN users resides on the headquarters core switch.

The of WAN bandwidth is 100 Mbps, the IP address of the WAN port is 192.168.197.222/24 (an IP address for tests and simulations, not the real carrier IP address), the IP address of the WAN gateway is 192.168.197.1, and the IP address of the LAN port is 172.16.1.1/24.

Gateways and Dynamic Host Configuration Protocol (DHCP) address pools of the AP and STA are deployed on the core switch. The AP resides on VLAN 3, and the STA resides on VLAN 4. The IP address of the AP gateway is 10.100.3.1, and the IP address of the STA gateway is 10.100.4.1.

The loopback IP address of the headquarters AC is 10.100.0.1. The SSID is wifi_test.

Branch

As a network egress, EG is connected to networks through a static IP address. The gateway for LAN users resides on the branch EG.

The WAN bandwidth is 10 Mbps, the IP address of the WAN port is 192.168.197.223/24 (an IP address for tests and simulations, not the real carrier IP address), the IP address of the WAN gateway is 192.168.197.1, and the LAN IP address is 10.10.3.0/24.

Gateways and DHCP address pools of the AP and STA are deployed on the branch EG. The AP resides on VLAN 3, and the STA resides on VLAN 4. The IP address of the AP gateway is 10.10.3.1, and the IP address of the STA gateway is 10.10.4.1.

The loopback IP address of the branch AC is 10.10.0.1. The SSID is wifi_test.

5.17.3.1 Deployment of Basic Networks for the Headquarters

After basic networks are deployed for the headquarters, the headquarters can access the Internet. Deployment of basic networks for the headquarters is not related to hierarchical ACs so that the networks can be deployed in traditional mode. However, deployment of hierarchical ACs is based on deployment of basic networks for the headquarters.

5.17.3.1.1 Configuration of Network Access Through the Headquarters EG

Network Topology

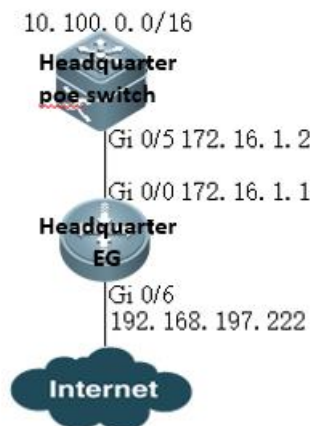

Networking Requirements

As a network egress, EG is connected to networks through a static IP address. The gateway for LAN users resides on the headquarters core switch.

The WAN bandwidth is 100 Mbps, the IP address of the WAN port is 192.168.197.222/24 (an IP address for tests and simulations, not the real carrier IP address), the IP address of the WAN gateway is 192.168.197.1, and the IP address of the LAN port is 172.16.1.1/24.

Configuration Tips

Confirm information on the WAN (for example, the IP address provided by the carrier) as well as the LAN and WAN ports (for example, the LAN port and WAN port of RG-EG2000K are marked with "LAN" and "WAN", respectively).

To connect a new EG to networks, start quick configuration. By default, the login IP address is 192.168.1.1, the user name and password are **admin**, and the LAN port ID is Gi0/0.

On the **Advanced** page, select **Enable NAT** and **Enable Route**, and configure the DNS.

Note: As the LAN is a private network, you need to enable NAT and routing to access the network. As a necessary parameter for system file updating and detection, the DNS must be configured.

Configuration Steps

Preparations

Set the PC IP address to 192.168.1.100/255.255.255.0. Insert the PC network cable into the EG port Gi0/0.

Enter the IP address of the EG LAN port (default IP address: 192.168.1.1; default user name/password: **admin/admin**) and log in to the router configuration page.



EasyGate

Multi-Function , Easy Management , Low Cost

Internet Explorer 10/11, Google Chrome, Firefox Recommended

[Forgot password?](#)

Quick Configuration

Setup Wizard

1 Network Mode

Gateway

Bridge

2 Interface

LAN Interface: Gi0/0 Gi0/1 Gi0/2 Gi0/3 Gi0/4 Gi0/5

Gi0/0: -

WAN Interface: Gi0/6 Gi0/7 ?

Gi0/6: - Mbps

- -

3 **Advanced** ▾

NAT: Enable

Route: Enable

Access Security: Shield Invalid/Virus Websites

DNS Server: If no available DNS is configured, remote upgrade may fail.

Web Access Port: (80, 1025 to 65535) Tip: Ensure that the port is not occupied and is not shielded.

Finish
Homepage

Note: As the IP address of Gi0/0 is changed from 192.168.1.1 to 172.16.1.1, you need to change the eWeb login IP address to 172.16.1.1.

Configure the back route to the LAN.

Ruijie EG

eWEB Administrator: admin

Home

Flow

Security

User

Network

Advanced

Interface

SUPER-VLAN

Route/Load

DNS Settings

VPN

NAT/Port Mapping

DHCP

Policy-Based Route
IP-Based Route

Priority: The policy-based route, application-based route, ar > static route > default route.

IP-Based Route: It can transmit packet according to the spe

+ Add Static Route
+ Add Default Route

Dest Network	Submask
0.0.0.0	0.0.0.0
0.0.0.0	0.0.0.0

Show No.:

Total Count:2

5-297

Add Static Route
✕

Dest Network: *

Submask: *

Outbound Interface:

Next Hop IP: * *(Gateway Address)*

Route: * *(The primary route will be given top priority. Backup route-N: A smaller N indicates a higher priority.)*

Configuration Verification

Connect the PC to the branch EG port Gi0/0, set the port IP address to 172.16.1.2/24, set the gateway IP address to 172.16.1.1, and select the local DNS. The Baidu page can be opened.

5.17.3.1.2 Configuration of the Headquarters Core Switch

Network Topology

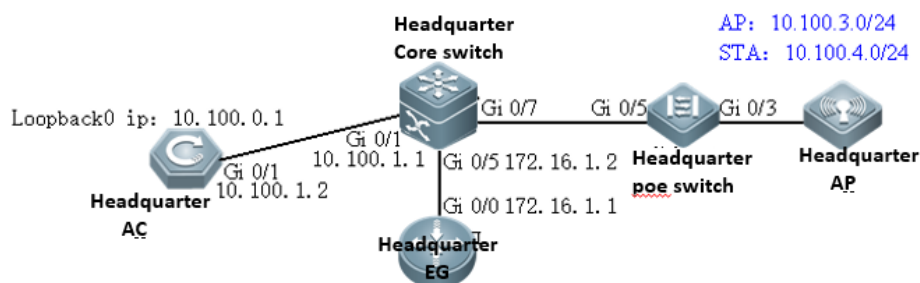

Networking Requirements

Gateways and DHCP address pools of the AP and STA are deployed on the core switch. The AP resides on VLAN 3, and the STA resides on VLAN 4. The IP address of the AP gateway is 10.100.3.1, and the IP address of the STA gateway is 10.100.4.1.

The loopback IP address of the headquarters AC is 10.100.0.1. The IP address of the headquarters core switch port Gi0/5 is 172.16.1.2, the IP address of Gi0/1 is 10.100.1.1, and the IP address of Gi0/3 is 10.100.2.1.

Configuration Steps

Preparations

Connect the PC to the core switch through a serial cable.

Configure DHCP address pools.

```
service dhcp
```

```
!
```

```
ip dhcp pool ap_vlan3      //Indicates the headquarters AP address pool.
```

```
option 138 ip 10.100.0.1
```

```
network 10.100.3.0 255.255.255.0 10.100.3.10 10.100.3.254
```

```
default-router 10.100.3.1
```

```
!
```

```
ip dhcp pool sta_vlan4    //Indicates the headquarters STA address pool.
```

```
network 10.100.4.0 255.255.255.0 10.100.4.10 10.100.4.254
```

```
dns-server 192.168.58.110
```

```
default-router 10.100.4.1
```

Configuring Ports, VLANs, and IP Addresses

```
vlan range 1,3,4    =====>VLAN 3 corresponds to the AP, and VLAN 4 corresponds to the STA.
```

```
!
```

```
interface GigabitEthernet 0/1    //Connects the headquarters AC.
```

```
no switchport
```

```
ip address 10.100.1.1 255.255.255.0
```

```
!
```

```
interface GigabitEthernet 0/5    //Connects the headquarters EG.
```

```
no switchport
```

```
ip address 172.16.1.2 255.255.255.0
```

```
!
```

```

interface GigabitEthernet 0/7    //Connects the PoE switch.
switchport mode trunk
switchport trunk native vlan 3
!
interface VLAN 3                //Indicates the headquarters AP gateway.
ip address 10.100.3.1 255.255.255.0
!
interface VLAN 4                //Indicates the headquarters STA gateway.
ip address 10.100.4.1 255.255.255.0
!
Configuring the Route
ip route 10.100.0.1 255.255.255.255 10.100.1.2    //Directs the route to the headquarters AC.
ip route 0.0.0.0 0.0.0.0 172.16.1.1            //Directs the route to the headquarters EG.

```

Configuration Verification

The large-scale network 192.168.197.1 can be pinged from the headquarters core switch.

5.17.3.1.3 Configuration of the Headquarters PoE Switch

Network Topology

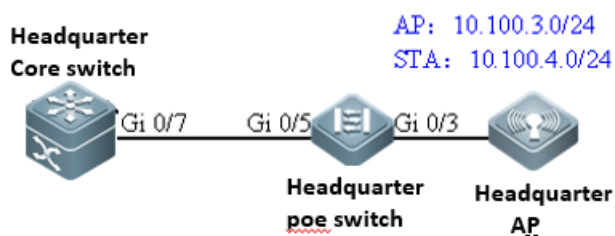

Networking Requirements

The AP resides on VLAN 3, and the STA resides on VLAN 4.

Configuration Steps

Preparations

Connect the PC to the PoE switch through a serial cable.

Configure ports, VLANs, and IP addresses.

```
vlan range 1,3,4      //VLAN 3 corresponds to the AP, and VLAN 4 corresponds to the STA.
```

```
!
```

```
interface GigabitEthernet 0/3    //Connects the headquarters AP.
```

```
switchport mode trunk
```

```
switchport trunk native vlan 3
```

```
switchport trunk allowed vlan only 3-4
```

```
poe enable
```

```
interface GigabitEthernet 0/5    //Connects the headquarters core switch.
```

```
switchport mode trunk
```

```
switchport trunk native vlan 3
```

```
switchport trunk allowed vlan only 3-4
```

```
poe enable
```

Configuration Verification

Show vlan:

```
ruijie# show vlan
VLAN Name                Status    Ports
-----
3  VLAN03                  STATIC    Gi0/3, Gi0/5
4  VLAN04                  STATIC    Gi0/3, Gi0/5
```

5.17.3.1.4 Configuration of the Headquarters AC

Network Topology

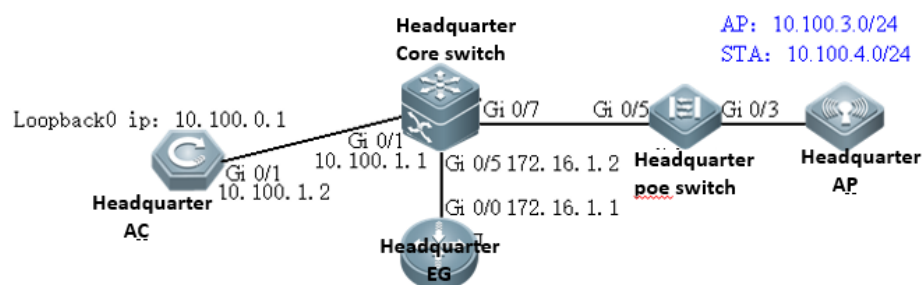

Networking Requirements

Set the IP address of Gi0/1 to 10.100.1.2. Configure the default route and direct the next hop to 10.100.1.1.

The loopback IP address of the branch AC is 10.100.0.1. Configuring the wireless network: The SSID is `wifi_test`, the ap-group name is **Headquarters**, the AP resides on VLAN 3, and the STA resides on VLAN 4.

Configuration Tips

By default, the Web service is enabled on the AC, the login IP address is 192.168.110.1, and the user name and password are **admin**. You can connect the PC to any port.

Configuration Steps

Preparations

Set the PC IP address to 192.168.110.100/255.255.255.0. Insert the PC network cable into any port of the AC.

Set the IP address of Gi0/1 to 10.100.1.2.



Access Control

Wireless Control, Communication Everywhere

IE8/9/10/11, Google Chrome, and 360 browsers are supported

Please enter the administrator username

Please enter the administrator password

Login

[Forgot your password?](#)

[Simplified Chinese](#)

The screenshot shows the Ruijie AC eWEB interface for a WS6008 model. The 'Port Settings' tab is selected, displaying a table of port configurations. The table has columns for Port, Link Status, Admin Status, Description, and Information. Ports GI0/1 through GI0/8 are listed, with GI0/1-5 and GI0/7-8 showing 'Down' link status and 'Up' admin status. GI0/6 is 'Up' for both. The information for GI0/6 includes IP address 192.168.40.20 and mask 255.255.255.0. The interface also shows a sidebar with navigation options like Monitor, Network, Security, and System.

Port	Link Status	Admin Status	Description	Information
GI0/1	Down	Up		
GI0/2	Down	Up		
GI0/3	Down	Up		
GI0/4	Down	Up		
GI0/5	Down	Up		
GI0/6	Up	Up		IPv4: 192.168.40.20, Mask: 255.255.255.0
GI0/7	Down	Up		
GI0/8	Down	Up		

Edit Port Gi0/1

Admin State: Up

IPv4: 10.100.1.2

Mask: 255.255.255.0

Description: link_to_core_switch

>> Advanced Settings

Save Cancel

Configure the default route and direct the next hop to 10.100.1.1.

Ruijie AC eWEB Model: WS6008 Detail

- Monitor
- Network
 - Route
- Security
- Optimiza
- Advanced
- System

Route Settings

Note: Route selection points based routing and a backup route when the primary route does not take than a backup route to the 2.

+ Add Static Route + Add Default Route X Delete Selected Route

<input type="checkbox"/>	Destination Subnet	Subnet Mask	Next Hop Address
--------------------------	--------------------	-------------	------------------

Show No.: 10 Total Count:0

Add Static Route

IP Type: IPv4 IPv6

Destination Subnet: *

Subnet Mask: *

Egress Port: ▾

Next Hop Address: *

Routing: ▾ ?

Configure the wireless network.

Ruijie AC eWEB Model: WS6008 Detail [Online Service](#) [Simplified Chinese](#)

Route Settings

Note: Route selection points based routing and a backup route when the primary route does not take effect, it will take a backup route to the backup route in accordance with the priority level configured to go, the backup route priority 1 higher than a backup route to the 2.

Topology Confirmation

AC connects with APs via switch

AC connects with APs directly

AC-AP Interconnection

The configuration items in this step are not displayed unless configured through EWeb wizard. If you have configured AC-AP interconnection in other ways, skip this step.

Tunnel Port: Double click the port and then you can configure the ports.

Gi0/1Gi0/2Gi0/3Gi0/4Gi0/5Gi0/7Gi0/8

Power on Non configurable configured

Tunnel IP: ?

Tunnel VLAN ID: ?

AP Network Configuration:

Vlan ID: DHCP: Configured on switch/gate▼+Add

[\[Configure DHCP on AC\]](#) [\[Configure VLAN gateway for AP\]](#)

Back Next

WiFi/WLAN Configuration

Wlan Id: * Range(1-2048)

SSID:

Encryption Type: ?

Advanced Settings

Packet Forwarding: Central Forwarding Local Forwarding ?

SSID code: utf-8 gbk

Hide SSID:

Max STA Count:

Network OFF Period:

Network Access Configuration

Associated AP Group ?	STA VLAN ID ?	STA DHCP Servi
Default <input type="text"/>	<input type="text"/>	<input type="text"/>

AP Settings

Note: Traffic refers to the sum of LAN port traffic in the CAPWAP tunnel, includi

GroupName-based Fil

AP Group Name: A

AP Group List

- All AP Groups
 - Default

AP Na

Show No.:

☰ Add AP Group

AP Group Name: *

Member AP:

☰ AP Settings

Note: Traffic refers to the sum of LAN port traffic in the CAPWAP tunnel, including STA and AP traffic.

GroupName-based Fl Search

AP Group Name: headquarter

AP Group List

- All AP Groups
 - Default
 - headquarter**

<input type="checkbox"/>	AP Name	AC

Show No.: Total Count:0

☰ Add AP
✕

AP Name: *

MAC: *

Location:

⌵ Advanced Settings

AP Group: ▾

Telnet Account:

Telnet Password: Show Password

Tunnel IP: ?

☰ Network Access Configuration
✕

Associated AP Group ?	STA VLAN ID ?	STA DHCP Service ?	Network Type	Support Radio ?	Action
<input type="text" value="headquarter"/> ▾	<input type="text" value="4"/>	<input type="text" value="Configured on switch/gateway"/> ▾	<input type="text" value="2.4G&5G"/> ▾	<input type="text"/>	✕ +Add

The preceding headquarters AC eWeb configuration corresponds to the following Command Line Interface (CLI).

```
wlan-config 1 wifi_test
ssid-code utf-8
tunnel local
!
ap-group headquarter
duplex full
description link to switch
ip address 10.100.1.2 255.255.255.0
```

```
!  
interface Loopback 0  
 ip address 10.100.0.1 255.255.255.255  
!  
ip route 0.0.0.0 0.0.0.0 10.100.1.1  
!
```

```
Ruijie#show ap-config running
```

```
Building configuration...  
Current configuration: 89 bytes
```

```
!!!!  
ap-config headquarters ap  
 ap-mac 00d0.f822.3320  
ap-group headquarters  
location headquarters  
!  
end  
Ruijie#
```

Configuration Verification

The mobile phone can be associated with the SSID wifi_test and can be connected to networks after being associated.

5.17.3.2 Deployment of Basic Networks for Branches

After basic networks are deployed for branches, the branches can access the Internet. Deployment of basic networks for the branches is not related to hierarchical ACs so that the networks can be deployed in traditional mode. However, deployment of hierarchical ACs is based on deployment of basic networks for branches.

5.17.3.2.1 Configuration of Network Access Through the Branch EG

Network Topology

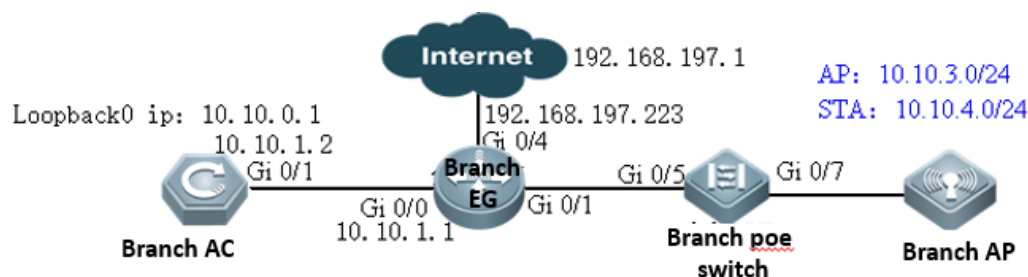

Networking Requirements

As a network egress, EG is connected to networks through a static IP address. The gateway for LAN users resides on the EG LAN port. You need to configure EG to access networks.

The WAN bandwidth is 10 Mbps, the IP address of the WAN port is 192.168.197.223/24 (an IP address for tests and simulations, not the real carrier IP address), the IP address of the WAN gateway is 192.168.197.1, and the IP address of the LAN port is 10.10.3.1/24.

Configuration Tips

Confirm information on the WAN (for example, the IP address provided by the carrier) as well as the LAN and WAN ports (for example, the LAN port and WAN port of RG-EG2000K are marked with "LAN" and "WAN", respectively).

To connect a new EG to networks, start quick configuration. By default, the login IP address is 192.168.1.1, the user name and password are **admin**, and the LAN port ID is Gi0/0.

On the **Advanced** page, select **Enable NAT** and **Enable Route**, and configure the DNS.

Note: As the LAN is a private network, you need to enable NAT and routing to access the network. As a necessary parameter for system file updating and detection, the DNS must be configured.

Configuration Steps

Preparations

Set the PC IP address to 192.168.1.100/255.255.255.0. Insert the PC network cable into the EG port Gi0/0.

Enter the IP address of the EG LAN port (default IP address: 192.168.1.1; default user name/password: **admin/admin**) and log in to the router configuration page.



EasyGate

Multi-Function , Easy Management , Low Cost

Internet Explorer 10/11, Google Chrome, Firefox
Recommended

[Forgot password?](#)

[Quick Configuration](#)

! Setup Wizard

1 Network Mode

Gateway

Bridge

2 Interface

LAN Interface: Gi0/0 Gi0/1 Gi0/2 Gi0/3 Gi0/4 Gi0/5

Gi0/0: -

WAN Interface: Gi0/6 Gi0/7 ?

Gi0/6: - Mbps

- -

3 Advanced

NAT: Enable

Route: Enable

Access Security: Shield Invalid/Virus Websites

DNS Server: If no available DNS is configured, remote upgrade may fail.

Web Access Port: (80, 1025 to 65535) Tip: Ensure that the port is not occupied and is not shielded.

[Homepage](#)

Note: As the IP address of Gi0/0 is changed from 192.168.1.1 to 10.10.3.1, you need to change the eWeb login IP address to 10.10.3.1.

Configuration Verification

Connect the PC to the branch EG port Gi0/0, set the port IP address to 10.10.1.2/24, set the gateway IP address to 10.10.1.1, and select the local DNS. The Baidu page can be opened.

5.17.3.2.2 Configuration of Branch EG Routes/DHCP

Network Topology

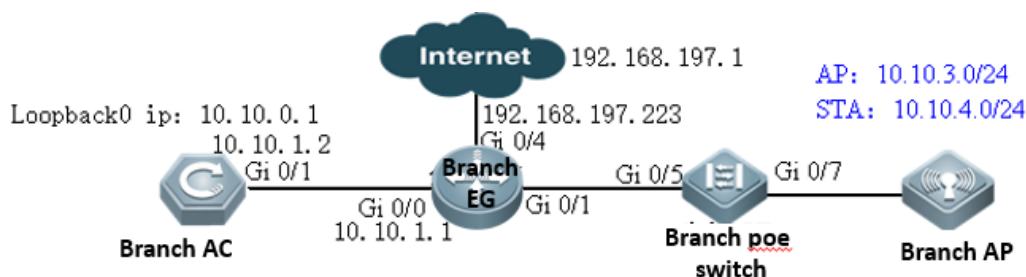

Networking Requirements

Gateways of the AP and STA are deployed on the branch EG. IP addresses of the gateways are 10.10.3.1 and 10.10.4.1, respectively. VLAN 3 corresponds to the AP, and VLAN 4 corresponds to the STA. Address pools of the AP and STA are deployed on the branch EG.

You need to configure the back route for the branch EG and set the IP address of the next hop (directed to 10.10.0.1) to 10.10.1.2.

Configuration Steps

Configure the IP addresses of AP and STA gateways.

The screenshot shows the Ruijie EG eWEB Administrator interface. The top left corner displays the Ruijie EG logo and the user 'admin'. The left sidebar contains navigation options: Home, Interface (selected), SUPER-VLAN, Flow, Route/Load, Security, DNS Settings, VPN, User, NAT/Port Mapping, Network, and DHCP. The main content area is titled 'LAN PortConfig Sub Interface' and has three tabs: 'Basic Settings', 'Multi-Dialup Line', and 'Aggregat'. A note states: 'Note: Click the corresponding interface to edit configuration. AnyIP: A successful gateway spoofing (ARP spoofing) attack allow network directly.' Below the note, there are two 'WAN Port' buttons (6 and 7) and four 'LAN Port' buttons (0, 1, 2, 3). A legend indicates that a green square represents 'Power-on' and a grey square represents 'Power-off'. The 'LAN Port 3' button is highlighted with a blue border, and the 'LAN PortConfig Sub Interface' text is highlighted with a red border.

Sub Interface: . * (Range: 1-1023)

VLAN ID: * (Range: 1-4087)

IP Address: *

Submask: *

AnyIP: Enable

Reverse Path Limited: Enable

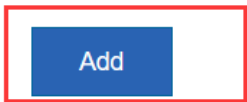

Sub Interface: . * (Range: 1-1023)

VLAN ID: * (Range: 1-4087)

IP Address: *

Submask: *

AnyIP: Enable

Reverse Path Limited: Enable

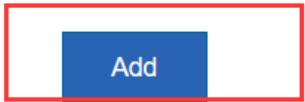

Configure AP and STA DHCP address pools.

The screenshot displays the Ruijie eWEB Administrator interface. The top left corner features the 'Ruijie EG' logo. The top right corner shows the user 'Administrator: admin'. A vertical navigation menu on the left includes categories: Home (Interface), Flow (SUPER-VLAN), Security (Route/Load, DNS Settings), User (VPN), Network (NAT/Port Mapping, DHCP), and Advanced. The 'DHCP' option under the 'Network' category is highlighted. The main content area has three tabs: 'Settings', 'Static IP Address', and 'User Lis'. The 'Settings' tab is active, and a red box highlights the 'DHCP: OFF' toggle switch.

The screenshot shows the Ruijie EG eWEB Administrator interface. The top left features the 'Ruijie EG' logo. The top right displays 'eWEB Administrator: admin'. A vertical navigation menu on the left includes icons and labels for Home, Flow, Security, User, Network, and Advanced. The 'Network' menu is expanded, showing options like Interface, SUPER-VLAN, Route/Load, DNS Settings, VPN, NAT/Port Mapping, and DHCP. The DHCP option is highlighted. The main content area has tabs for 'Settings', 'Static IP Address', and 'User List'. The 'Settings' tab is active and contains a '+ Add DHCP' button (highlighted with a red box), a 'Delete Selected DHCP' button, and an 'Exclude' button. Below these buttons is a table with columns for a checkbox, 'Name', and 'IP Address'. The table is currently empty. At the bottom of the table area, there is a 'Show No.:' dropdown menu set to '10' and a 'Total Count:0' label.

Add DHCP

Pool Name: *

Subnet: * Format: 192.168.1.0

Mask: * Format: 255.255.255.0

Default Gateway: * Format: 192.168.1.1

Lease Time: Permanent Lease Time: d h min *

Preferred DNS Server: * Format: 114.114.114.114

Secondary DNS Server:

Option 43:

Save **Cancel**

Option 138:

When multi IP addresses exist , please separate them by comma. (Format:192.168.23.14, 192.168.24.14)

Save **Cancel**

☰ Add DHCP ✕

Pool Name: *

Subnet: * Format: 192.168.1.0

Mask: * Format: 255.255.255.0

Default Gateway: * Format: 192.168.1.1

Lease Time: Permanent Lease Time d h min *

Preferred DNS Server: * Format: 114.114.114.114

Secondary DNS Server:

Option 43: ?

Configure the back route.

The screenshot shows the Ruijie EG eWEB Administrator interface. The left sidebar contains navigation options: Home, Flow, Security, User, Network, and Advanced. The main content area is titled "IP-Based Route" and includes tabs for "Policy-Based Route", "IP-Based Route", and "Load Balance". Below the tabs, there is explanatory text about route priority and IP-based routes. Two buttons, "+ Add Static Route" and "+ Add Default Route", are highlighted with a red box. Below these buttons is a table with columns "Dest Network", "Submask", and "Next". The table contains two rows of data. At the bottom, there is a "Show No.:" dropdown menu set to "10" and "Total Count:2".

Ruijie EG eWEB Administrator: admin

Policy-Based Route **IP-Based Route** Load Balance

Priority: The policy-based route, application-based route, and IP-based route all send packets in the order of priority: policy-based route > application-based route > static route > default route.

IP-Based Route: It can transmit packet according to the specified path and includes

+ Add Static Route + Add Default Route

Dest Network	Submask	Next
0.0.0.0	0.0.0.0	1
0.0.0.0	0.0.0.0	19

Show No.: 10 Total Count:2

☰ **Add Static Route**
✕

Dest Network: *

Submask: *

Outbound Interface: ▾

Next Hop IP: * *(Gateway Address)*

Route: ▾ * *(The primary route will be given top priority. Backup route-N: A smaller N indicates a higher priority.)*

OK
Cancel

5.17.3.2.3 Configuration of Branch PoE Switches

Network Topology

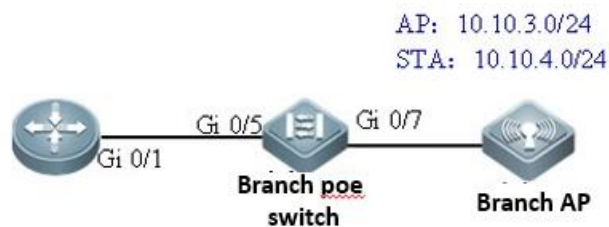

Networking Requirements

The AP resides on VLAN 3, and the STA resides on VLAN 4.

Configuration Steps

Preparations

Connect the PC to the PoE switch through a serial cable.

Configure ports and VLAN.

vlan range 1,3,4 =====>VLAN 3 corresponds to the AP, and VLAN 4 corresponds to the STA.

!

interface GigabitEthernet 0/7 =====>Connects the branch AP.

switchport mode trunk

switchport trunk native vlan 3

switchport trunk allowed vlan only 3-4

poe enable

interface GigabitEthernet 0/5 =====>Connects the branch EG.

switchport mode trunk

switchport trunk allowed vlan only 3-4

poe enable

Configuration Verification

| Show vlan :

ruijie# show vlan

VLAN Name	Status	Ports
3 VLAN03	STATIC	Gi0/3, Gi0/5
4 VLAN04	STATIC	Gi0/3, Gi0/5

5.17.3.2.4 Configuration of Branch ACs

Network Topology

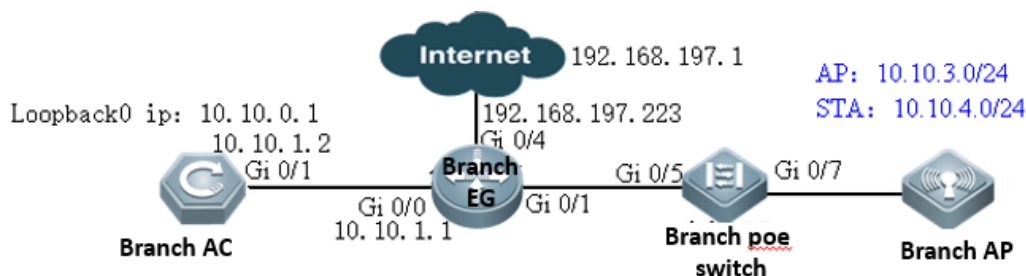

Networking Requirements

Set the IP address of Gi0/1 to 10.10.1.2. Configure the default route and direct the next hop to 10.10.1.1.

The loopback IP address of the branch AC is 10.10.0.1. Configuring the wireless network: The SSID is wifi_test, the ap-group name is **Branch**, the AP resides on VLAN 3, and the STA resides on VLAN 4.

Configuration Tips

By default, the Web service is enabled on the AC, the login IP address is 192.168.110.1, and the user name and password are **admin**. You can connect the PC to any port.

Configuration Steps

Preparations

Set the PC IP address to 192.168.110.100/255.255.255.0. Insert the PC network cable into any port of the AC.

Set the IP address of Gi0/1 to 10.10.1.2.



Access Control

Wireless Control, Communication
Everywhere

IE8/9/10/11, Google Chrome, and 360 browsers are supported

[Forget your password?](#)

[Simplified Chinese](#) |

The screenshot shows the Ruijie AC eWEB interface. The left sidebar contains navigation options: Monitor (VLAN, Port), Network (Route, DHCP), Security (Ebag), Optimize (Multicast/Unicast, STP), Advanced (Load Balancing), System (VRRP, CWMP, iBeacon). The main content area is titled 'Port Settings' and displays a table of port configurations. The 'Port Settings' tab is highlighted with a red box. The table lists ports Gi0/1 through Gi0/8 with their Link Status and Admin Status. Gi0/1 through Gi0/5 and Gi0/7 are 'Down', while Gi0/6 and Gi0/8 are 'Up'. A summary row shows 'IPv4: 192.168.40.20, Mask: 255.255.255.0'. At the bottom, there is a pagination control showing 'Show No.: 10' and 'Total Count:8'.

Port	Link Status	Admin Status	Description	Information
Gi0/1	Down	Up		
Gi0/2	Down	Up		
Gi0/3	Down	Up		
Gi0/4	Down	Up		
Gi0/5	Down	Up		
Gi0/6	Up	Up		IPv4: 192.168.40.20, Mask: 255.255.255.0
Gi0/7	Down	Up		
Gi0/8	Down	Up		

Edit Port Gi0/1 ✕

Admin State:

IPv4:

Mask:

Description: Can not contain special characters such as '?' and '#'.

[» Advanced Settings](#)

Configure the default route and direct the next hop to 10.10.1.1.

Ruijie AC eWEB Model: WS6008 [Detail](#)

Monitor: VLAN, Port

Network: **Route**

Security: DHCP, Ebag

Optimiza: Multicast/Unicast

Advanced: STP, Load Balancing

System: VRRP, CWMP, iBeacon, Multimedia Gateway, Virtual AP

Route Settings

Note: Route selection points based routing and a backup route with a higher priority than a backup route to the 2.

[+ Add Static Route](#) [+ Add Default Route](#) [X Delete S](#)

<input type="checkbox"/>	Destination Subnet	Subnet Mask
--------------------------	--------------------	-------------

Show No.: Total Count:0

☰ Add Static Route ✕

IP Type: IPv4 IPv6

Destination Subnet: *

Subnet Mask: *

Egress Port: ▾

Next Hop Address: *

Routing: ▾ ?

Configure the wireless network.

Ruijie AC eWEB Model: WS6008 Detail

WiFi/WLAN

WIFI/WLAN Settings

Note: It is recommended to configure English SSIDs.

+ Add WIFI/WLAN ✕ Delete Selected WIFI/WLAN

Wlan Id	SSID	Associated AP Group	Associated STAs	Forward
No Record Found				

☰ Topology Confirmation

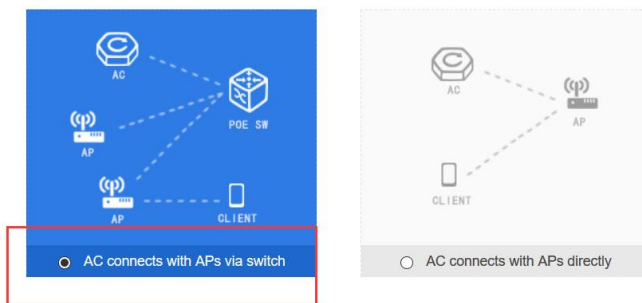

AC-AP Interconnection

The configuration items in this step are not displayed unless configured through EWeb wizard. If you have configured AC-AP interconnection in other ways, skip this step.

Tunnel Port: Double click the port and then you can configure the ports.

Gi0/1 Gi0/2 Gi0/3 Gi0/4 Gi0/5 Gi0/7 Gi0/8

Power on Non configurable configured

Tunnel IP: ?

Tunnel VLAN ID: ?

AP Network Configuration:

Vlan ID: <input type="text" value="3"/>	DHCP	Configured on switch/gate▼	✕	+Add
---	------	----------------------------	---	------

[\[Configure DHCP on AC\]](#) [\[Configure VLAN gateway for AP\]](#)

WiFi/WLAN Configuration

Wlan Id: * Range(1-2048)

SSID:

Encryption Type: ?

Advanced Settings

Packet Forwarding: Central Forwarding Local Forwarding ?

SSID code: utf-8 gbk

Hide SSID:

Max STA Count:

Network OFF Period:

Network Access Configuration

Associated AP Group [?](#) **STA VLAN ID** [?](#) **STA**

Default

AP Settings

Note: Traffic refers to the sum of LAN port traffic in the C

GroupName-based Fil

AP Group List

- All AP Groups
 - Default
 - headquarter

☰ **Add AP Group**

AP Group Name: *

Member AP:

☰ **Add AP**

AP Name: *

MAC: *

Location:

⌵ **Advanced Settings**

AP Group:

Telnet Account:

Telnet Password: Show Password

Tunnel IP: ?

Save

Cancel

Network Access Configuration					
Associated AP Group	STA VLAN ID	STA DHCP Service	Network Type	Support Radio	Action
branch	4	Configured on switch/gateway	2.4G&5G		✕ +

The preceding headquarters AC eWeb configuration corresponds to the following CLI.

```
wlan-config 2 wifi_test
  ssid-code utf-8
  tunnel local
!
ap-group branch
  interface-mapping 2 4 ap-wlan-id 1
!
ac-controller
  capwap ctrl-ip 10.10.0.1
!
vlan 3
!
vlan 4
!
interface GigabitEthernet 0/1
  no switchport
  speed 10
  duplex full
  description to_coreswitch
  ip address 10.10.1.2 255.255.255.0
!
interface Loopback 0
```

```
ip address 10.10.0.1 255.255.255.255
```

```
!
```

```
ip route 0.0.0.0 0.0.0.0 10.10.1.1
```

```
!
```

```
Ruijie#show ap-config running
```

```
Building configuration...
```

```
Current configuration: 89 bytes
```

```
!!!!
```

```
ap-config branch_ap
```

```
ap-mac 00d0.f822.3320
```

```
ap-group branch
```

```
location branch
```

```
!
```

```
end
```

```
Ruijie#
```

Configuration Verification

The mobile phone can be associated with the SSID `wifi_test` and can be connected to networks after being associated.

5.17.3.3 Deployment of Paths Between Branches and the Headquarters

After paths are deployed between branches and the headquarters, branch and headquarters ACs can access each other. In a general education system, the main paths between branches and the headquarters are usually education MANs (equivalent to dedicated lines) and the auxiliary paths are VPNs. In an enterprise, the main paths are VPNs and the auxiliary paths are dedicated lines. Deployment of paths between branches and the headquarters is not related to hierarchical ACs so that the paths can be deployed in traditional mode. However, deployment of hierarchical ACs is based on deployment of paths between branches and the headquarters.

5.17.3.3.1 Interworking Between the Headquarters and Branches Through Dedicated Lines

A dedicated line is equivalent to an LAN. No example is needed because deployment and configuration are simple.

5.17.3.3.2 Establishing VPN Paths Between the Headquarters and Branches

Network Topology

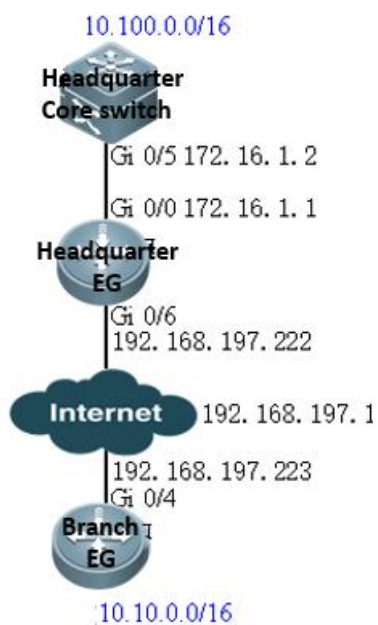

Networking Requirements

When an IPsec VPN is established between branch and headquarters, the 10.10.0.0/16 segment of the branch and the 10.100.0.0/16 segment of the headquarters can access each other.

Configuration Steps

Configure the headquarters EG.

Ruijie EG eWEB Administrator: admin Setup Wizard

VPN

Home Interface

Flow SUPER-VLAN

Security Route/Load

User DNS Settings

VPN

NAT/Port Mapping

Network DHCP

Advanced

What is VPN?

Technology for establishing LANs on the Internet
Virtual Private Network (VPN) refers to the technology for establishing a data transmission channel that can be established between two nodes or data through this channel without external interference or eavesdropping.

Small LANs form large LANs
Branches access the VPN of the headquarters to share information.

Mobile users access company network
Employees who go home or have business trips can access the VPN.

[Configure](#)

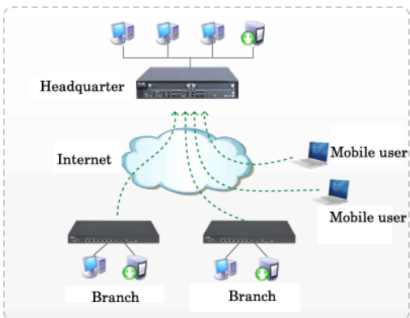

Welcome to VPN Config Wizard

Select a Position:

Headquarter
Establish VPN, let others or equipment and I connection



Branch
Establish VPN, connected to the headquarters



Internet

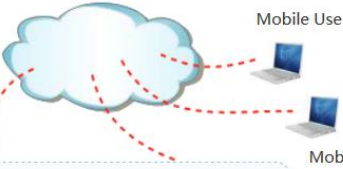

1 Network Position

2 Branch Type

3 VPN Type

4 Finish

[Back](#) [Next](#)

Welcome to VPN Config Wizard

Select a Branch Type:

Mobile User 

Branch 

1 Network Position

2 Branch Type

3 VPN Type

4 Finish

Back Next

Welcome to VPN Config Wizard

Recommended VPN Types:
You can change the VPN type.

Branch  L2TP IPsec L2TP IPsec

1 Network Position

2 Branch Type

3 VPN Type

4 Configure IPsec

5 Finish

i PPTP/L2TP: Support access authentication without data encryption.
IPsec: Support data encryption.
L2TP IPsec: Support access authentication and data encryption.

Back Next

Welcome to VPN Config Wizard

Configure IPSec Parameter ← here I input ruijie

Pre-shared Key: [.....] * ?

Local ID ? : Enable

Network Config Wizard		
Local Network	The branch network	Outbound Interface
10.100.0.0	10.10.0.0	Gi0/6
255.255.0.0	255.255.0.0	

» Advance Settings

Back Next

Configure the branch EG.

Ruijie EG WEB Administrator: admin Setup Wizard

VPN

What is VPN?

Technology for establishing LANs on the Internet
Virtual Private Network (VPN) refers to the technology for establishing a data transmission channel that can be established between two nodes or data through this channel without external interference or eavesdropping.

Small LANs form large LANs
Branches access the VPN of the headquarters to share the information.

Mobile users access company network
Employees who go home or have business trips can access the VPN.

Configure

Welcome to VPN Config Wizard

Select a Position:

- Headquarter**
Establish VPN, let others or equipment and I connection
- Branch**
Establish VPN, connected to the headquarters

Internet

Mobile User

Mobile User

Branch

Branch

Back Next

Welcome to VPN Config Wizard

Enter Basic Information.

VPN Type: IPSec

HQ Public IP/Domain Name: 192.168.197.222 * +IP/URL ?

Pre-shared Key: ●●●●●● * should be ruijie

Interface: Gi0/4 ?

Network Config Wizard				
Local Network		HQ Network		
10.10.0.0	255.255.255.0	10.100.0.0	mask	+
				×

>> Advance Settings

Back Next

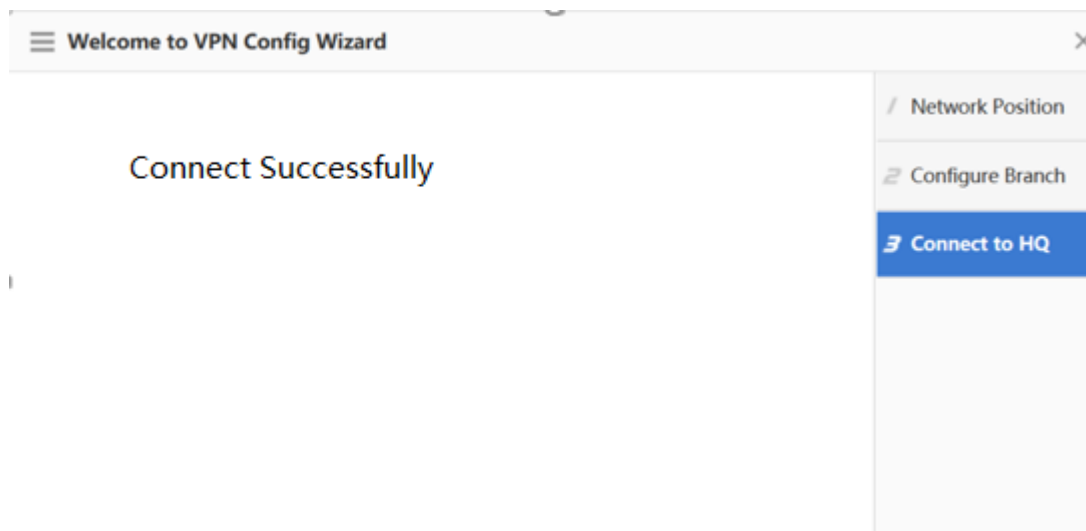

Configuration Verification

Log in to the Web console of the branch AC and ping the loopback IP address of the headquarters AC from the branch AC. Confirm that the loopback IP address can be pinged.

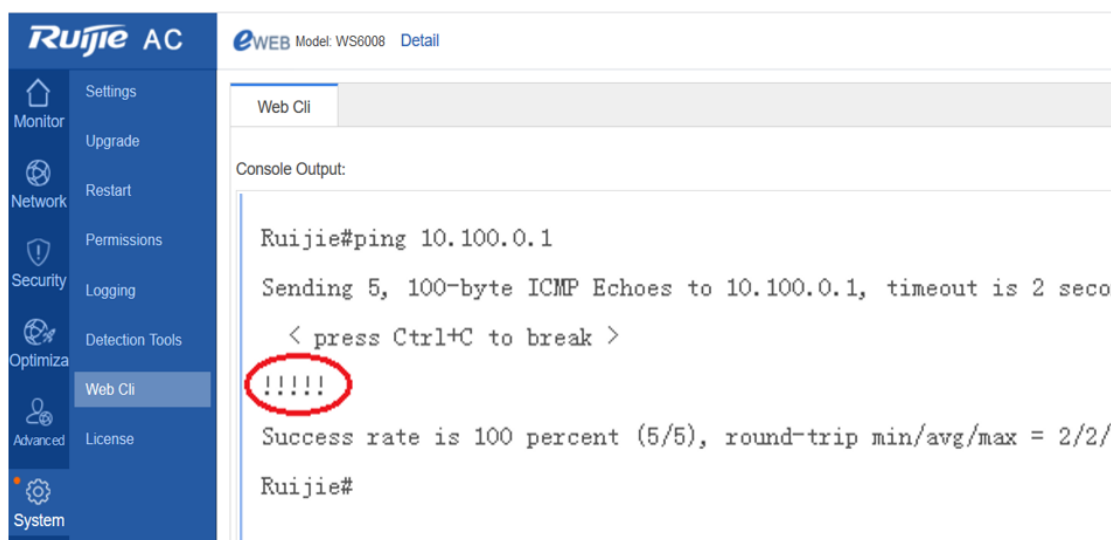

5.17.3.3 Mapping Addresses of LANs to WANs for Interworking

Mapping some LAN addresses to WANs through NAT is not allowed for office networks because it is not safe. In addition, currently all egress devices support IPsec VPN. Therefore, it is not recommended to expose LAN addresses on public networks through NAT.

5.17.3.4 Deployment of Hierarchical Relationship Between Center and Branch ACs

5.17.3.4.1 Establishing a Hierarchical Relationship

Networking Requirements

A hierarchical relationship needs to be established between center and branch ACs.

Configuration Steps

Hierarchical ACs back up data of center and branch devices by using the hot backup technology to enable failover. Therefore, wireless networks need to be deployed for the headquarters as if during hot backup deployment so that when branch ACs fail the center AC can take over branches with the same configuration. Therefore, the following operations should be performed on the center AC.

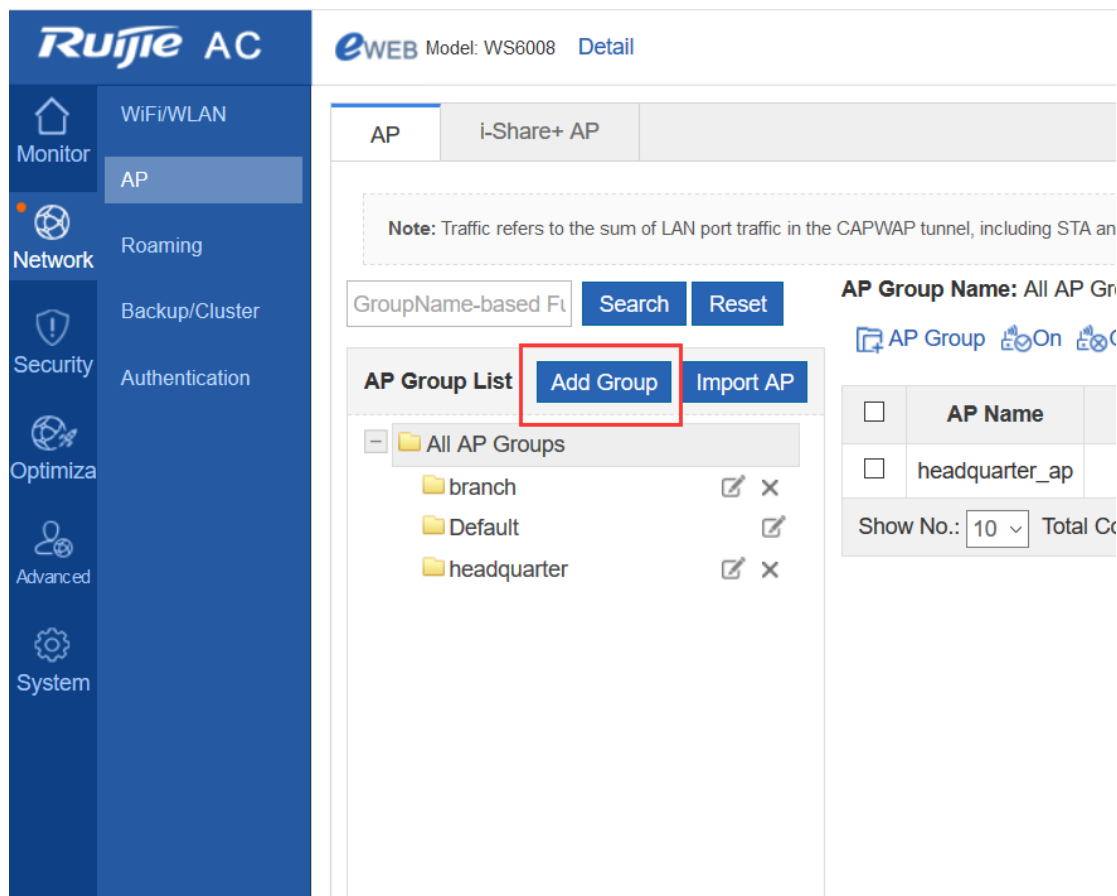

☰ Add AP Group ✕

AP Group Name: *

Member AP:

The screenshot shows the Ruijie AC eWEB interface for Model WS6008. The left sidebar contains navigation menus for Monitor, Network, Security, and Optimization. The main content area is titled 'i-Share+ AP' and includes a search filter for 'AP Group Name: branch'. Below the search bar, there is an 'AP Group List' section showing a tree view with 'All AP Groups' and a sub-group 'branch'. A context menu is open over the 'branch' group, with the 'Add AP' option highlighted in red. Other options in the menu include 'Delete AP' and 'Restart AP'. A note at the top of the main area states: 'Note: Traffic refers to the sum of LAN port traffic in the CAPWAP tunnel, including STA and AP traffic.'

☰ Add AP ✕

AP Name: *

MAC: *

Location:

⌵ Advanced Settings

AP Group: ▾

Telnet Account:

Telnet Password: Show Password

Tunnel IP: ?

Ruijie AC eWEB Model: WS6008 [Detail](#)

WiFi/WLAN Settings

Note: It is recommended to configure English SSIDs.

+ Add WiFi/WLAN **X Delete Selected WiFi/WLAN**

<input type="checkbox"/>	Wlan Id	
--------------------------	---------	--

Show No.: Total Count:0

WiFi/WLAN Configuration

Wlan Id: * Range(1-2048)

SSID:

Encryption Type: ?

Advanced Settings

Packet Forwarding: Central Forwarding Local Forwarding ?

SSID code: utf-8 gbk

Hide SSID:

Max STA Count:

Network OFF Period:

☰ Network Access Configuration

Associated AP Group ?	STA VLAN ID ?	STA DHCP Service ?	Network Type	Support F
branch ▾	4	Configured on switch/gateway▼	2.4G&5G ▾	

The preceding eWeb configuration corresponds to the following CLI.

```
wlan-config 2 wifi_test
  ssid-code utf-8
  tunnel local
!
ap-group branch
  interface-mapping 2 4 ap-wlan-id 1
!
vlan 4
!

Ruijie#show ap-config running

Building configuration...
Current configuration: 89 bytes

!!!!
ap-config branch_ap
  ap-mac 00d0.f822.3320
  ap-group branch
  location branch
!
end
Ruijie#
```

Configure branch ACs to establish a hierarchical relationship between center and branch ACs.

The screenshot displays the Ruijie AC eWEB interface for a WS6008 model. The left sidebar contains navigation menus for Monitor, Network, Security, Optimiza, Advanced, and System. The main content area is titled 'Layer AC' and includes a 'Detail' link. A note instructs the user to complete configurations. Below this, it states the current mode is 'Normal AC'. A dropdown menu is open, showing options for 'Branch AC', 'Center AC', and 'Normal AC'. The 'Branch AC' option is highlighted in blue, and a 'Configuration' button is visible next to it. Red boxes highlight the 'Branch AC' option in the dropdown and the 'Configuration' button.

Ruijie AC eWEB Model: WS6008 [Detail](#)

Monitor: WiFi/WLAN, AP

Network: Roaming

Backup/Cluster

Security: Authentication

Optimiza

Advanced

System

Backup Cluster

Note: The backup function provides millisecond-level CAPWAP tunnel

+ Add Hot Backup X Delete Selected

<input type="checkbox"/>	Hot Backup Name	Tunnel IP of Peer AC

Show No.: 10 Total Count:0

Add Hot Backup X

Hot Backup Name:

Tunnel IP of Peer AC: * Interface address of backup AC.

Backup: Enable *If the hot backup capacity exceeds the limit, the device cannot be enabled with hot backup*

Work Mode:

Service ID: New *Please enter a service ID in the range of 0-65535. share the same service ID.*

Backup AP Group: * [\[AP Settings\]](#)

>> Advanced Settings

The preceding eWeb configuration corresponds to the following CLI.

wlan hot-backup branch //Indicates that the device is a branch AC, which reflects the major difference between hierarchical ACs and common wireless hot backup.

```

!
wlan hot-backup 10.100.0.1 //Indicates the CAPWAP tunnel IP address of the headquarters AC, which must be pinged to
establish a hierarchical relationship.

description headquarters

!

context 10

priority level 7 //Indicates that the priority level is 7, which supports switchback during failback.

 ap-group branch

!

wlan hot-backup enable

```

Configure branch ACs to establish a hierarchical relationship between center and branch ACs.

The screenshot displays the Ruijie AC eWEB interface. The left sidebar contains a navigation menu with the following items: Dashboard, Monitor (Layer AC), Network (AP Info, User Info), Security, Optimiza, and Advanced. The main content area is titled 'Layer AC' and shows the configuration for Model WS6008. A note states: 'Please take the following steps to complete configurations: 1. Configure the headquarter AC or branch'. Below this, it indicates 'The device current mode is Normal AC'. A dropdown menu is open, showing the current mode 'Center AC' and the available options: Center AC, Branch AC, and Normal AC. The 'Center AC' option is highlighted in blue.

The screenshot shows the Ruijie AC eWEB interface. The left sidebar contains navigation menus: Monitor (WiFi/WLAN, AP), Network (Roaming, Backup/Cluster), Security (Authentication), Optimiza, Advanced, and System. The main content area is titled 'Backup/Cluster' and includes a 'Note' about millisecond-level CAPWAP tunnel backup. Below the note are two buttons: '+ Add Hot Backup' (highlighted with a red box) and 'X Delete Selected'. A table with two columns, 'Hot Backup Name' and 'Tunnel IP of Peer AC', is currently empty. At the bottom of the table area, there is a 'Show No.' dropdown set to '10' and a 'Total Count:0' indicator.

The 'Add Hot Backup' dialog box contains the following fields and options:

- Hot Backup Name:
- Tunnel IP of Peer AC: * Interface address of backup AC.
- Backup: Enable *If the hot backup capacity exceeds the limit, the device cannot be enabled with hot backup*
- Work Mode: ▾
- Service ID: New * The primary AC and the backup AC share the same service ID.
- Backup AP Group: ▾ * [\[AP Settings\]](#)

At the bottom of the dialog, there is a link for 'Advanced Settings' and two buttons: 'OK' and 'Cancel'.

The preceding eWeb configuration corresponds to the following CLI.

wlan hot-backup center //Indicates that the device is a center AC, which reflects the major difference between hierarchical ACs and common wireless hot backup.

!

wlan hot-backup 10.10.0.1 //Indicates the CAPWAP tunnel IP address of the branch AC, which must be pinged to establish a hierarchical relationship.

description branch //Describes branch ACs to help you tell them apart.

!

context 10

ap-group branch

!

wlan hot-backup enable

Check branch ACs on the center AC. The branch ACs are "Online".

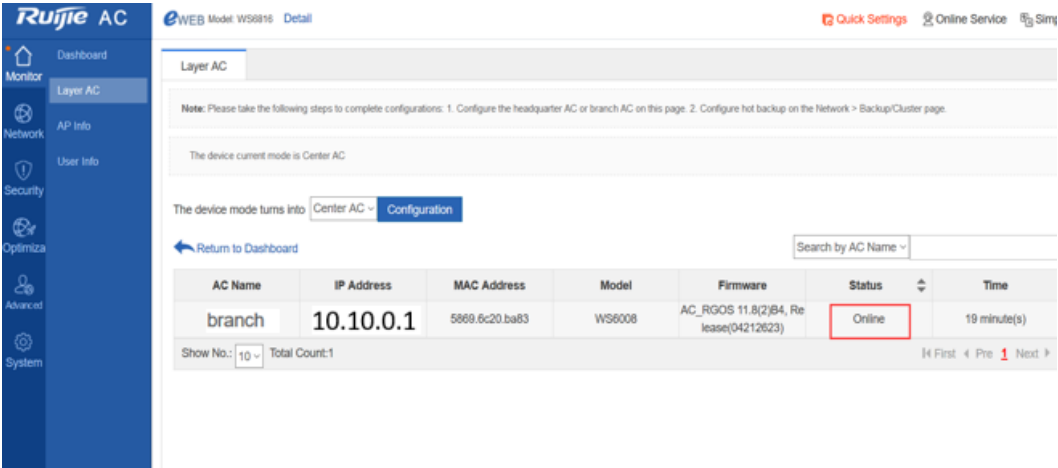

The screenshot shows the Ruijie AC WEB interface. The left sidebar contains navigation options: Monitor, Layer AC, Network, AP Info, User Info, Security, Optimiza, Advanced, and System. The main content area is titled 'Layer AC' and includes a note about configuration steps, a message indicating the device is in Center AC mode, and a dropdown menu for device mode (Center AC - Configuration). Below this is a table of ACs with the following data:

AC Name	IP Address	MAC Address	Model	Firmware	Status	Time
branch	10.10.0.1	5869.6c20.ba83	WS6008	AC_RGOS 11.8(2)B4, Release(04212623)	Online	19 minute(s)

The 'Status' column for the 'branch' AC is highlighted with a red box. Below the table, there is a 'Show No.' dropdown set to 10 and a 'Total Count: 1' indicator. Navigation buttons for 'First', 'Pre', 'Next', and 'Last' are also visible.

Check APs on the center AC. Both branch and center APs are "Online".

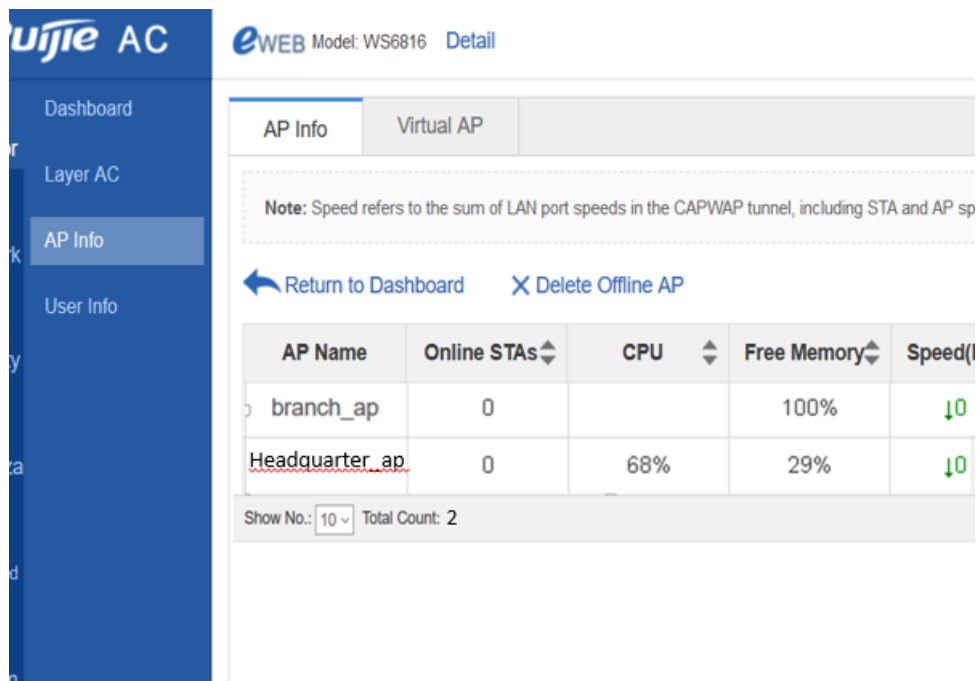

After the mobile phone is associated with the SSID wifi_test, whether in the headquarters or branches, it can be connected to networks.

If branch ACs fail, the mobile phone can be connected to networks. If the mobile phone is disassociated and then associated, it can be connected to networks.

5.17.3.4.2 Monitoring Hierarchical Networks in Unified Mode

On the center AC, you can check which branch ACs are online, branch AC name, IP address, model, status, software version, CPU utilization, memory utilization, number of APs, and number of users.

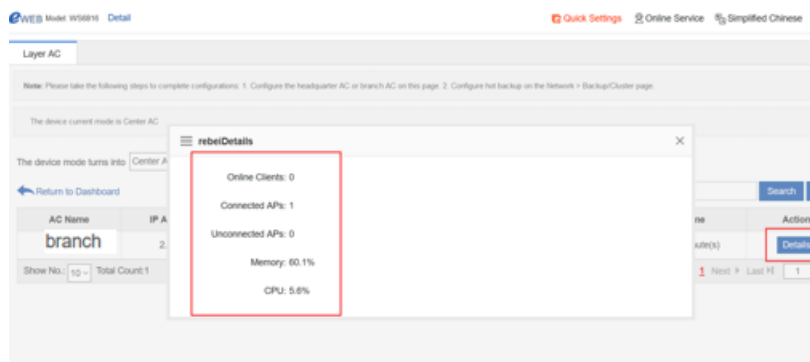

On the center AC, you can check which APs are online and to which branch each AP belongs.

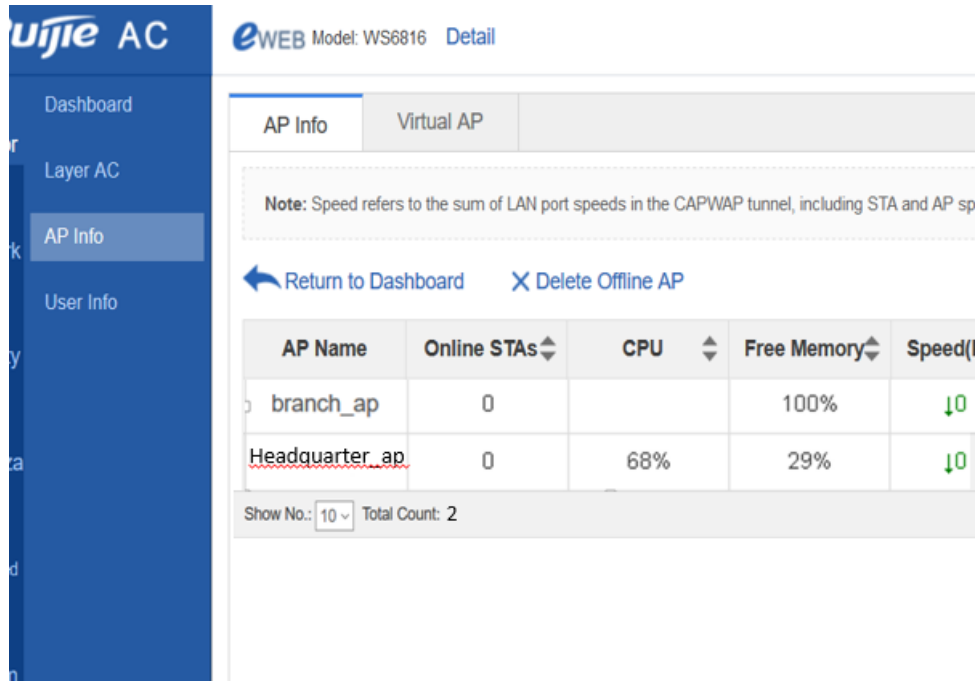

On the center AC, you can check which terminals are online and to which branch each terminal belongs.

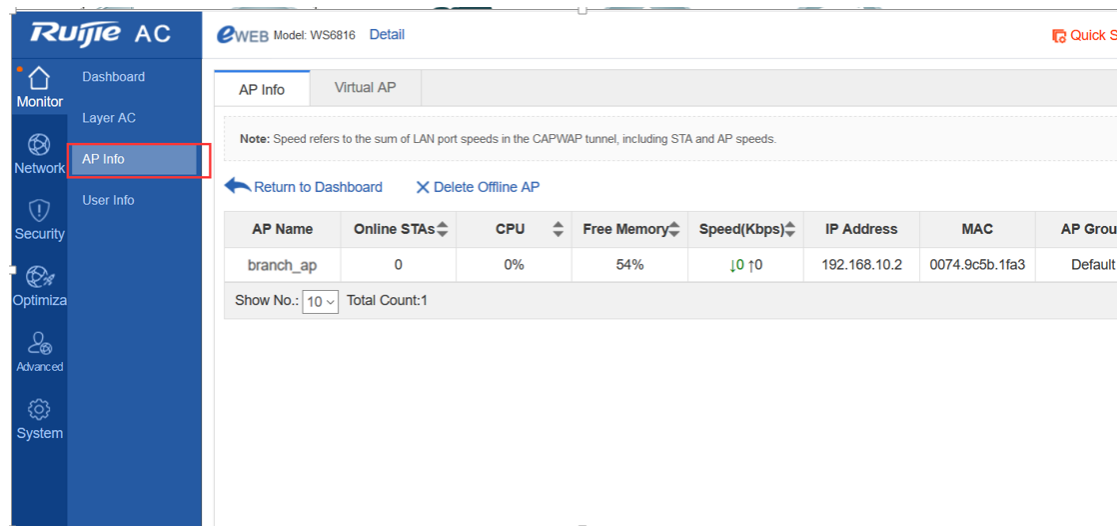

5.17.3.4.3 Upgrading Hierarchical Networks in Unified Mode

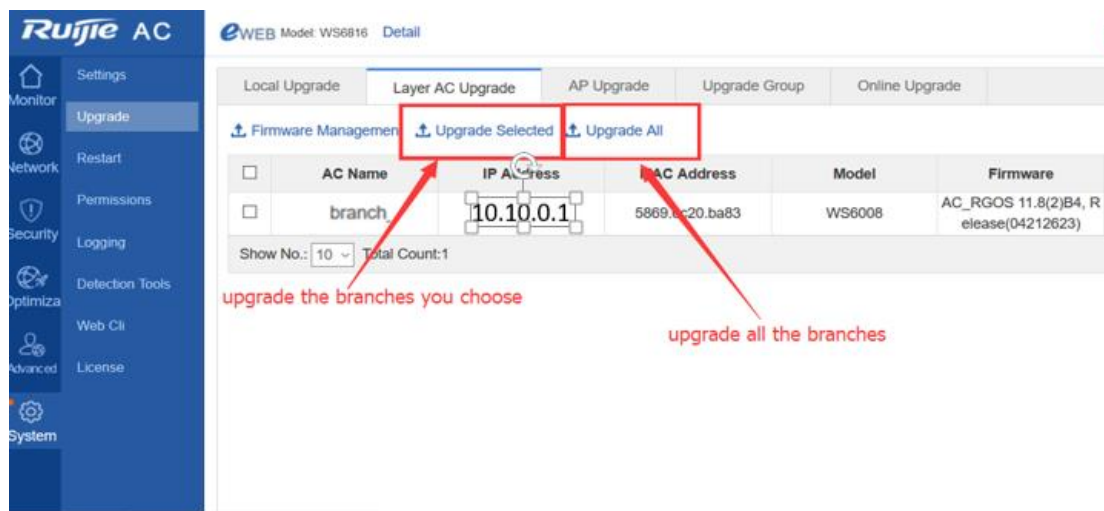

Note: Currently, you can upload version files to the flash memory or use a USB flash disk to upgrade devices. For the ACs without USB ports (WS6812 and WS6816 support USB flash disks, while M8600E-WS-ED and M18000-WS-ED do not support USB flash disks), if multiple models of ACs and APs exist in a branch, the flash memory space may be inadequate for .bin files of all ACs and APs; therefore, devices need to be upgraded in batches.

If the flash memory space is inadequate, you can delete some idle .bin files on eWeb to make room for new .bin files.

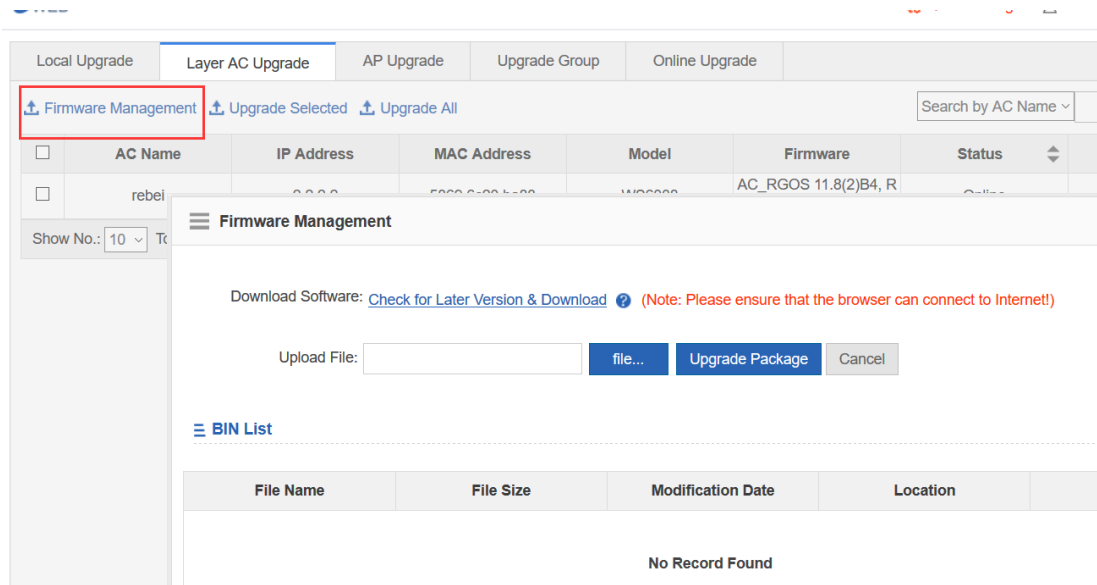

Alternatively, you can enter the `tree` command on the CLI, find all .bin files, and delete idle ones to make room for new .bin files.

```
^@CenterAC#
CenterAC# tree
|-- AP_RGOS11.1(5)B01_S1C4-01_04171208_install_740_0512.bin
|-- AP_RGOS11.1(5)B01_S1C4-01_04171609_install_ap740_0516.bin
|-- Server.cfg
|-- addr
|-- ap-config.text
|-- ap-standalone.text
|-- ap-virtual_switch.text
|-- bridge_msg_loop
|-- config.cyx.2017.1.24
|-- config.text
|-- config_20170311.text
|-- config_vac.dat
|-- dev
|-- httpd_cert.crt
|-- httpd_key.pem
|-- hwd.db
|-- layer_ac_bin
  |-- AC_RGOS11.8(2)B3_G2C6-02_04171204_install_WS5848_0512.bin
|-- portal
  |-- ext_zip
  |-- logo
```

5.17.3.5 Deployment Authentication

5.17.3.5.1 Centralized Authentication in the Headquarters

Network Topology

Networking Requirements

The authentication server is connected to the headquarters core switch, and its IP address is 10.100.2.2.

The following uses dot1x authentication as an example. The user name and password are **test**.

Configuration Steps

Select dot1x authentication for ACs in branches and headquarters, as shown in the following figure.

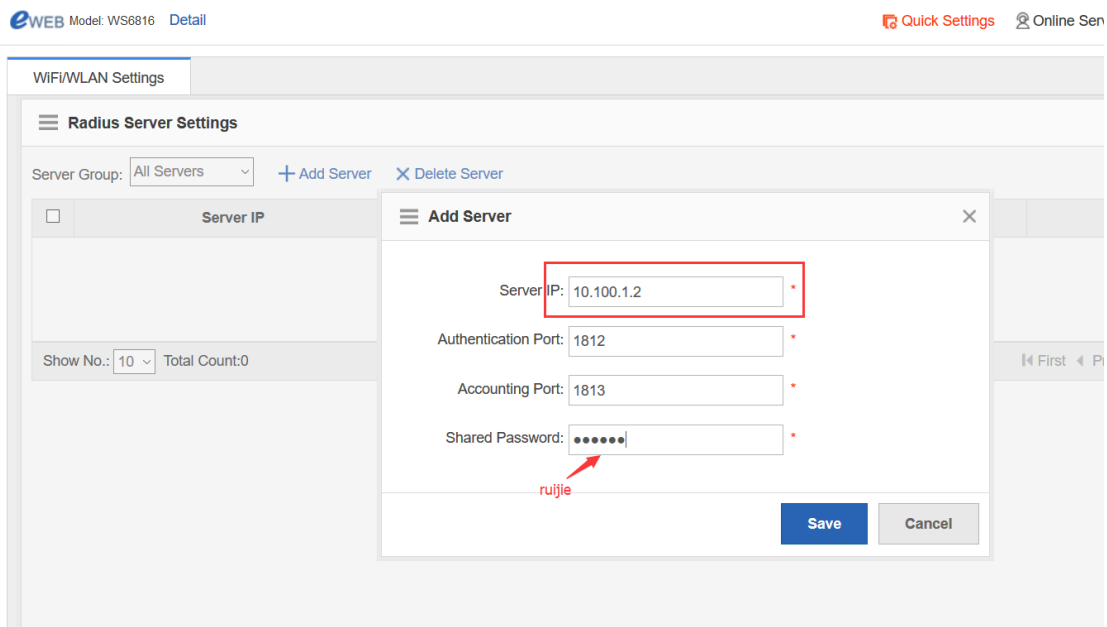
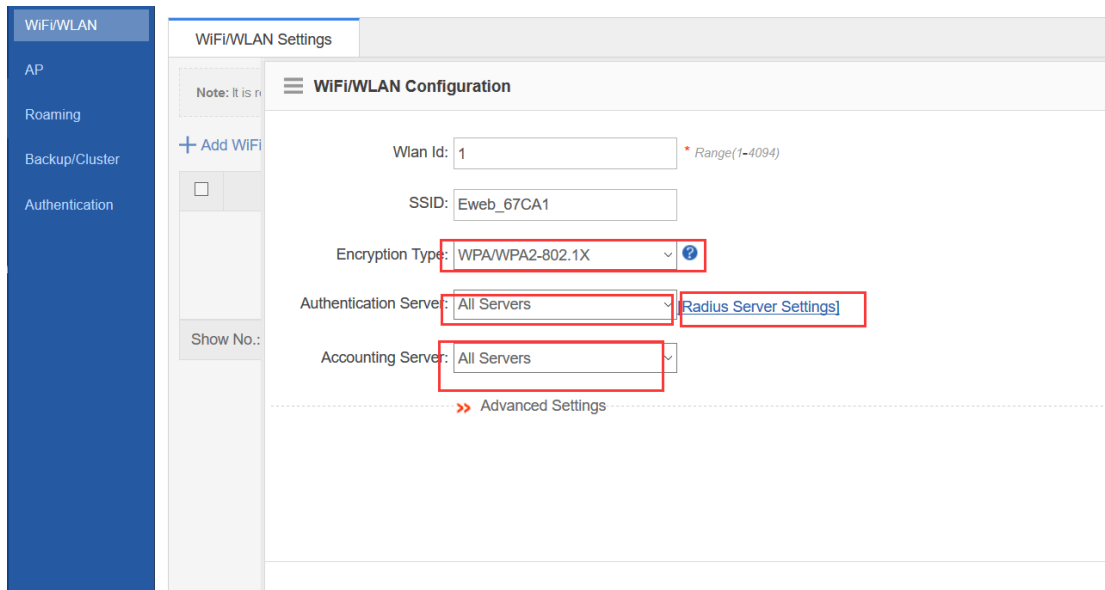

On the RADIUS server, add devices (center and branch ACs) and register an account (in the following figure, the center AC is added; branch ACs should be added following the same procedures). Then correlate the mobile phone to wifi_test, and enter the user name and password.

Authentication & Authority > Device > Query

NAS IP: NAS Configuration Templates:

NAS Name:

Totally 16 Records | Each Page 20 Records | Page 1 / totally 1 Page:

All	None	NAS IP	NAS MAC
<input type="checkbox"/>	<input type="checkbox"/>	10.10.1.31	58696c14
<input type="checkbox"/>	<input type="checkbox"/>	10.10.1.63	14144b5f7
<input type="checkbox"/>	<input type="checkbox"/>	10.10.11.11	58696c7cl
<input type="checkbox"/>	<input type="checkbox"/>	172.16.20.1	58696C9DI
<input type="checkbox"/>	<input type="checkbox"/>	172.18.158.191	
<input type="checkbox"/>	<input type="checkbox"/>	172.29.100.1	58696c5ec
<input type="checkbox"/>	<input type="checkbox"/>	172.29.101.20	58696c5bc
<input type="checkbox"/>	<input type="checkbox"/>	172.29.2.10	58696c20t

Authentication & Authority > Device > Add

Basic Information

* NAS IP: (Format: 192.168.20.1)

* NAS Configuration Templates: [Obtain Device Information](#) | [View](#)

NAS MAC: (Format: 00D0F8000001)

NAS Name:

NAS Location:

NAS Information:

Tips:
You can set a template for the devices sharing the same SNMP version, authentication a

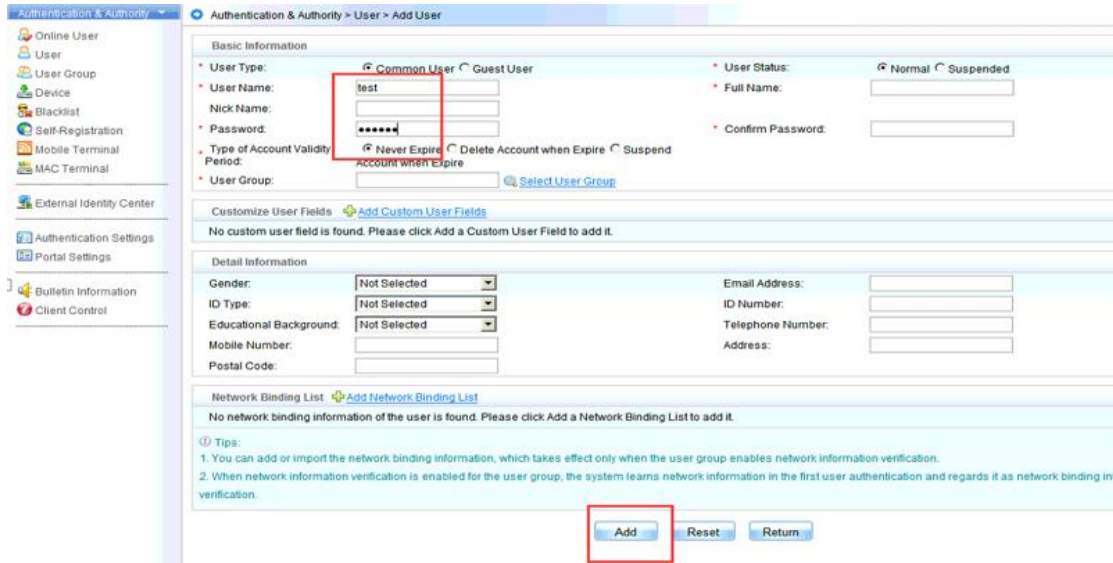
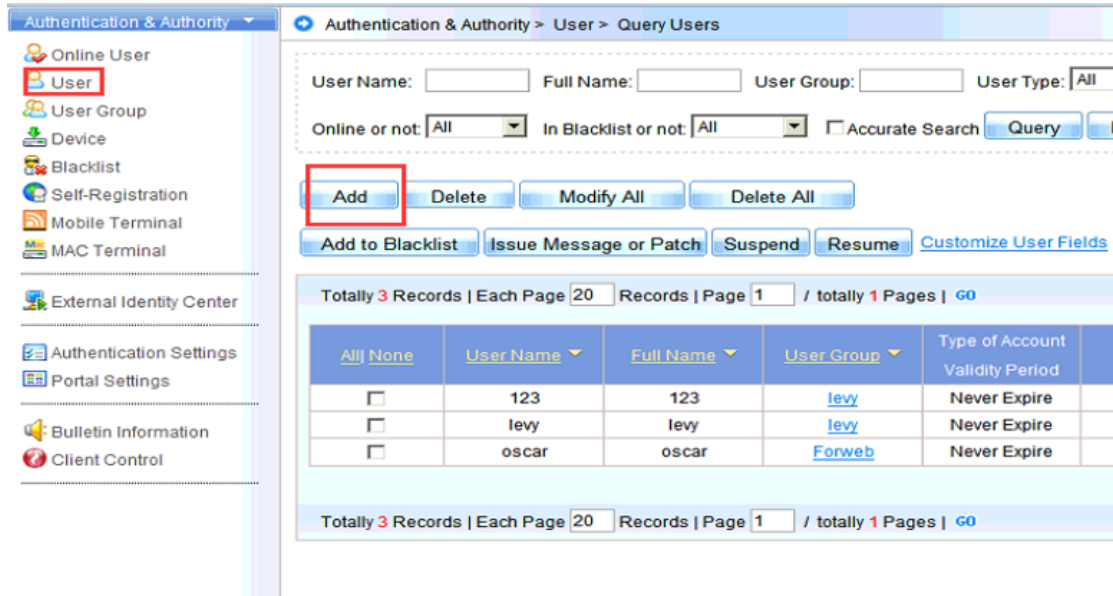

Configuration Verification

Correlate the terminal to wifi_test, select dot1x authentication, and enter the user name and password. The terminal can be connected to the network.

5.17.3.5.2 Distributed Authentication in the Headquarters

There is no difference between deployment for distributed authentication and deployment for centralized authentication except the IP addresses of local authentication servers are used as those of the authentication servers on ACs. Deployment for distributed authentication in hierarchical AC mode is detailed in the ESS/IPC Configuration Guide.

5.18 Smart AP

5.18.1 Overview

5.18.1.1 Background

Access points (APs) are used for mobile offices. For safety, ports cannot be mapped to public networks on access controllers (ACs). Layer 2 Tunneling Protocol (L2TP) is used to establish tunnels between APs and the headquarters egress gateway, based on which CAPWAP tunnels are established. ACs assign network access configurations to forward in centralized mode, which significantly simplifies network access configuration for AP mobile offices. Figures 1-2(1) and 1-2(2) show common scenarios.

Figure 1-2(1) AP Point-to-Point Protocol over Ethernet (PPPoE) dial-up scenario



In the preceding scenario, the number is dialed through PPPoE on the AP, and then the AP is connected to large-scale networks. An L2TP tunnel is established between the AP and egress gateway. A CAPWAP tunnel is established between the AP and AC through the L2TP tunnel.

Figure 1-2(2) AP Dynamic Host Configuration Protocol (DHCP) scenario

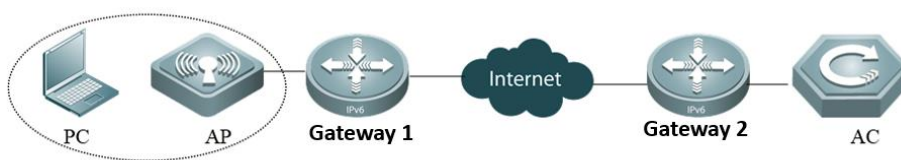

In the preceding scenario, the AP obtains the IP address from Gateway 1 through DHCP. An L2TP tunnel is established between the AP and Gateway 2. A CAPWAP tunnel is established between the AP and AC through the L2TP tunnel.

1.2 Components and Version

Area	Product Name	Function	Version	Remarks
Branch	Wireless AP	Wireless forwarding path	Later than	Supported by specific

Area	Product Name	Function	Version	Remarks
			V11.8PJ4	versions and models
	Power over Ethernet (PoE) switch	PoE	Unlimited	N/A
	Easy Gateway (EG)	Gateway, VPN, traffic control, and network address translation (NAT)	Unlimited	N/A
Headquarters	Wireless AP	Wireless forwarding path	Later than V11.x B8	N/A
	PoE switch	PoE	Unlimited	N/A
	Wireless AC	Box wireless AP controller or board-style (N18K) wireless AP controller	Unlimited	N/A
	Gateway switch	Gateway	Unlimited	N/A
	EG	Gateway, VPN, traffic control, and NAT	Unlimited	N/A

5.18.2 Preparation for Deployment

5.18.2.1 Device Selection

Branch APs must be able to support Virtual Private Dial-up Network (VPDN) clients. Therefore, you need to use AP130(W2), AP520, AP520-I, AP520-I(G2), AP520(W2), AP720-I, AP740-I, and AP740-I(C).

5.18.3 Deployment Guide

APs can be connected to networks through DHCP, PPPoE, or static IP addresses, as shown in Figures 3-1 and 3-2.

Figure 3-1 Connecting APs to networks through DHCP

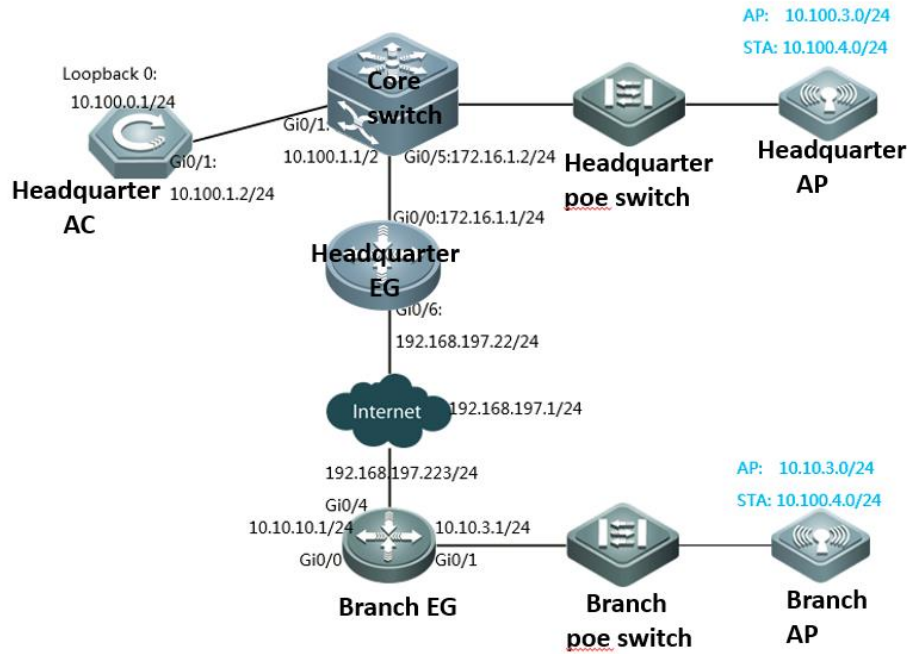

Figure 3-2 Connecting APs to networks through PPPoE

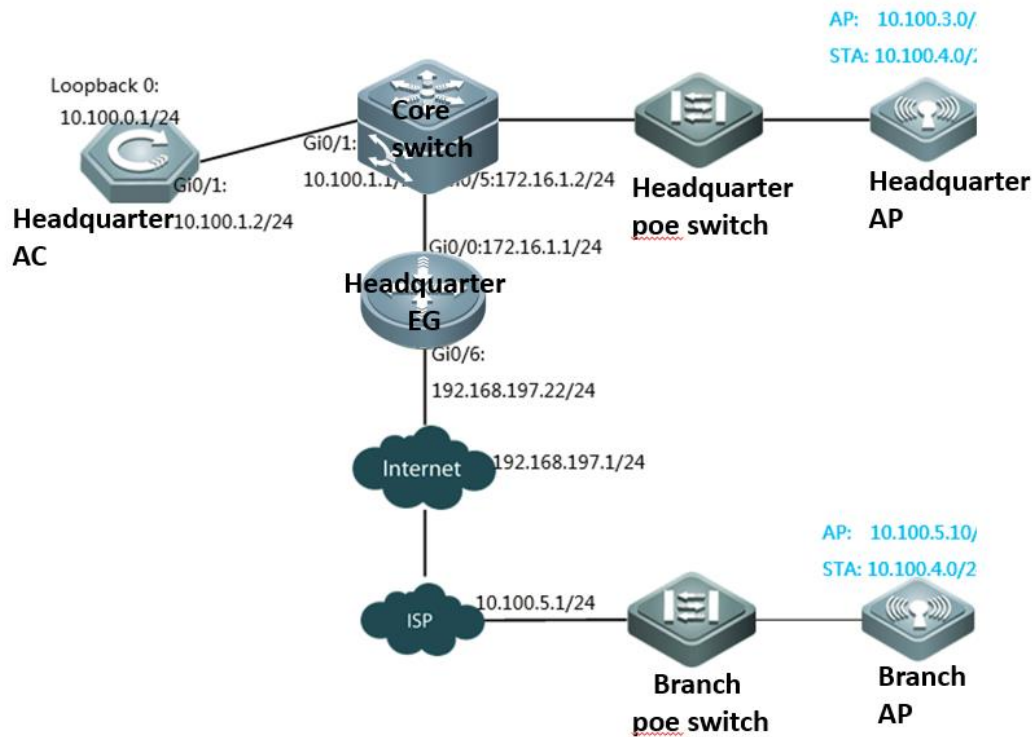
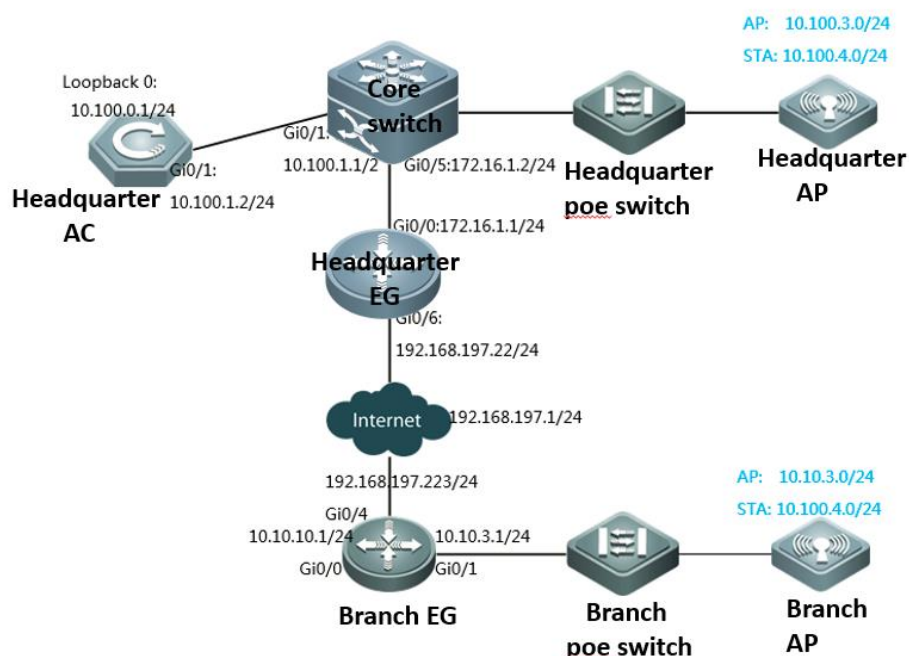

Figure 3-3 Connecting APs through static IP addresses



The following uses the preceding figures to describe solution deployment.

Headquarters

As a network egress, EG is connected to networks through a static IP address. The gateway for Local Area Network (LAN) users resides on the headquarters core switch.

The Wide Area Network (WAN) bandwidth is 100 Mbps, the IP address of the WAN port is 192.168.197.222/24 (an IP address for tests and simulations, not the real carrier IP address), the IP address of the WAN gateway is 192.168.197.1, and the IP address of the LAN port is 172.16.1.1/24.

Gateways and DHCP address pools of the AP and STA are deployed on the core switch. The AP resides on VLAN 3, and the STA resides on VLAN 4. The IP address of the AP gateway is 10.100.3.1, and the IP address of the STA gateway is 10.100.4.1.

The loopback IP address of the headquarters AC is 10.100.0.1. The Service Set Identifier (SSID) is wifi_test.

Branch (DHCP)

As a network egress, EG is connected to networks through a static IP address. The gateway for LAN users resides on the branch EG.

The WAN bandwidth is 10 Mbps, the IP address of the WAN port is 192.168.197.223/24 (an IP address for tests and simulations, not the real carrier IP address), the IP address of the WAN gateway is 192.168.197.1, and the LAN IP address is 10.10.3.0/24.

The gateway and DHCP address pool of the AP are deployed on the branch EG. The AP resides on VLAN 3. The IP address of the AP gateway is 10.10.3.1.

The gateway and address pool of the STA are deployed on the headquarters core switch. The IP address of the STA gateway is 10.100.4.1.

Branch (PPPoE):

A static IP address is configured for the branch AP. The IP address of the AP gateway is 10.10.5.1. The IP address of the AP is 10.100.5.10 (an IP address for tests and simulations, not the real carrier IP address).

The gateway and address pool of the STA are deployed on the headquarters core switch. The IP address of the STA gateway is 10.100.4.1.

Static IP address

The number is dialed through PPPoE on the AP. The IP address of the AP gateway is 10.10.3.1. The IP address of the AP is 10.100.3.10 (an IP address for tests and simulations, not the real carrier IP address).

The gateway and address pool of the STA are deployed on the headquarters core switch. The IP address of the STA gateway is 10.100.4.1.

5.18.3.1 Deployment of Basic Networks for the Headquarters

After basic networks are deployed for the headquarters, the headquarters can access the Internet. Deployment of basic networks for the headquarters is not related to smart APs so that the networks can be deployed in traditional mode. However, deployment of smart APs is based on deployment of basic networks for the headquarters.

5.18.3.1.1 Configuration of Network Access Through the Headquarters EG

Network Topology

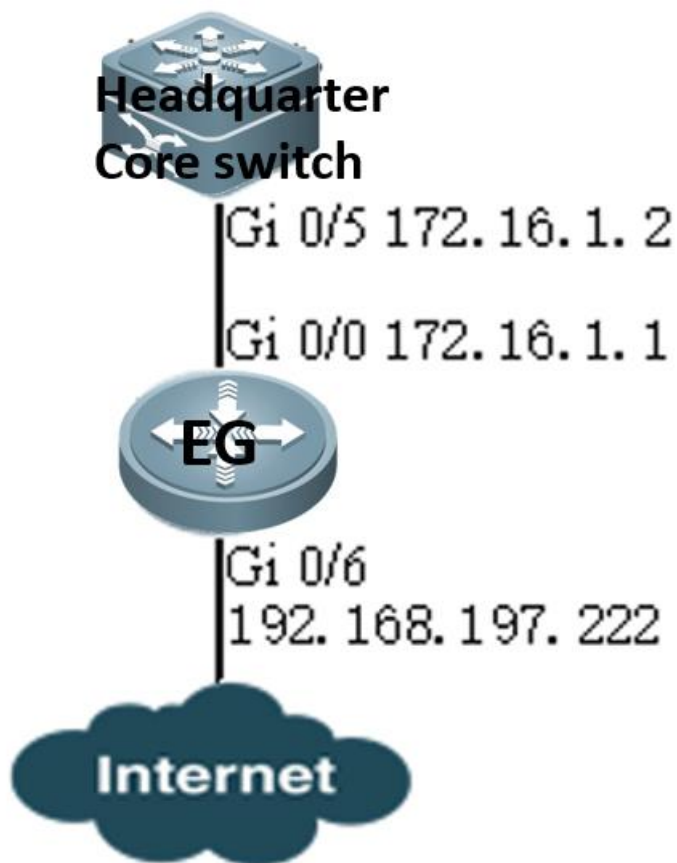

Networking Requirements

As a network egress, EG is connected to networks through a static IP address. The gateway for LAN users resides on the headquarters core switch.

The WAN bandwidth is 100 Mbps, the IP address of the WAN port is 192.168.197.222/24 (an IP address for tests and simulations, not the real carrier IP address), the IP address of the WAN gateway is 192.168.197.1, and the IP address of the LAN port is 172.16.1.1/24.

Configuration Tips

Confirm information on the WAN (for example, the IP address provided by the carrier) as well as the LAN and WAN ports (for example, the LAN port and WAN port of RG-EG2000K are marked with "LAN" and "WAN", respectively).

To connect a new EG to networks, start quick configuration. By default, the login IP address is 192.168.1.1, the user name and password are **admin**, and the LAN port ID is Gi0/0.

On the **Advanced** page, select **Enable NAT** and **Enable Route**, and configure the DNS.

Configure the VPDN server.

Note: As the LAN is a private network, you need to enable NAT and routing to access the network. As a necessary parameter for system file updating and detection, the DNS must be configured.

Configuration Steps

Enter the IP address of the EG LAN port (default IP address: 192.168.1.1; default user name/password: **admin/admin**) and log in to the router configuration page.



EasyGate

Multi-Function , Easy Management , Low Cost

Internet Explorer 10/11, Google Chrome, Firefox Recommended

Please enter the username

Please enter the password

Log In

[Forgot password?](#)

Quick Configuration

! Setup Wizard

1 Network Mode ▾

Gateway

Bridge

2 Interface ▾

LAN Interface: Gi0/0 Gi0/1 Gi0/3 Gi0/4 Gi0/5

Gi0/0: -

WAN Interface: Gi0/2 Gi0/6 Gi0/7 ?

Gi0/2: - Mbps

- -

3 Advanced ▸

[Homepage](#)

Advanced ▾

NAT: Enable

Route: Enable

Access Security: Shield Invalid/Virus Websites

DNS Server: If no available DNS is configured, remote upgrade may fail.

Web Access Port: (80, 1025 to 65535) Tip: Ensure that the port is not occupied and is not shielded.

[Finish](#) [Homepage](#)

Note: As the IP address of Gi0/0 is changed from 192.168.1.1 to 172.16.1.1, you need to change the eWeb login IP address to 172.16.1.1.

Configure the back route to the LAN.

The screenshot shows the Ruijie EG eWEB Administrator interface. The left sidebar contains navigation options: Home, Interface, SUPER-VLAN, Flow, Route/Load, Security, DNS Settings, VPN, User, NAT/Port Mapping, Network, DHCP, and Advanced. The main content area is titled "eWEB Administrator: admin" and has three tabs: "Policy-Based Route", "IP-Based Route" (highlighted with a red box), and "Load Balance". Below the tabs, there is explanatory text: "Priority: The policy-based route, application-based route, and IP-based route all s > static route > default route." and "IP-Based Route: It can transmit packet according to the specified path and includ". Below this text are two buttons: "+ Add Static Route" (highlighted with a red box) and "+ Add Default Route". A table below the buttons shows the current configuration:

Dest Network	Submask	N
0.0.0.0	0.0.0.0	

At the bottom, there is a control for the number of items to display: "Show No.: Total Count: 1".

Add Static Route

Dest Network: *

Submask: *

Outbound Interface: ▾

Next Hop IP: * (Gateway Address)

Route: ▾ * (The primary route will be given top priority. Backup route-N: A smaller N indicates a higher priority.)

Configure the VPDN server.

The screenshot shows the Ruijie EG eWEB Administrator interface. The left sidebar contains navigation options: Home, Interface, SUPER-VLAN, Flow, Route/Load, Security, DNS Settings, User, NAT/Port Mapping, Network, DHCP, and Advanced. The 'VPN' option is highlighted with a red box. The main content area is titled 'VPN' and features a diagram of a VPN network topology. The diagram shows a 'Headquarter' with a server and several desktop computers, connected to an 'Internet' cloud. Two 'Branch' locations are shown, each with a server and desktop computers. 'Mobile user' icons are also shown connected to the Internet cloud. To the right of the diagram is a section titled 'What is VPN?' with the following text: 'Technology for establishing LANs on the Internet', 'Virtual Private Network (VPN) refers to the technology that can establish a secure data transmission channel between a local area network and a remote area network through the Internet without external interference', 'Small LANs form large LANs', 'Branches access the VPN of the headquarters to share resources', and 'Mobile users access company network', 'Employees who go home or have business trips can access the company network through the Internet'. A blue 'Configure' button is located at the bottom right of the diagram area.

Welcome to VPN Config Wizard

Select a Position:

- Headquarter**
Establish VPN, let others or equipment and I connection
- Branch**
Establish VPN, connected to the headquarters

Network Position

- 1 Network Position
- 2 **Configure Branch**
- 3 Connect to HQ

Back Next

Ruijie EG eWEB Administrator: admin Setup Wizard Cookbook Alarm

VPN

Welcome to VPN Config Wizard

Enter Basic Information.

VPN Type: L2TP IPsec

HQ Public: L2TP

IP/Domain Name: IPsec +IP/URL

Pre-shared Key: *

User Name: *

Password: *

HQ Network: IP - +

>> Advance Settings

Back Next

Welcome to VPN Config Wizard

Enter Basic Information

Client IP Range: ~ *

Please make sure that the IP addresses are not in use in the LAN.

HQ Domain Name:

Primary DNS Server:

Secondary DNS Server:

If a mobile user wants to access the LAN through the domain name, a DNS server address should be configured which is usually the same with the address of the LAN DNS server.

>> Advance Settings

Back Next

- 1 Network Position
- 2 Branch Type
- 3 VPN Type
- 4 Configure Basic Info**
- 5 Manage Account
- 6 Finish

Welcome to VPN Config Wizard

Save Account on

Local Device Other System ?

Add Branch User Name: Password: Add

Type:	User Name	Action
Show No.: <input type="text" value="10"/>	Total Count:0	First Previous 1 Next Last <input type="text" value="1"/> GO

Back Next

- 1 Network Position
- 2 Branch Type
- 3 VPN Type
- 4 Configure Basic Info
- 5 Manage Account**
- 6 Finish

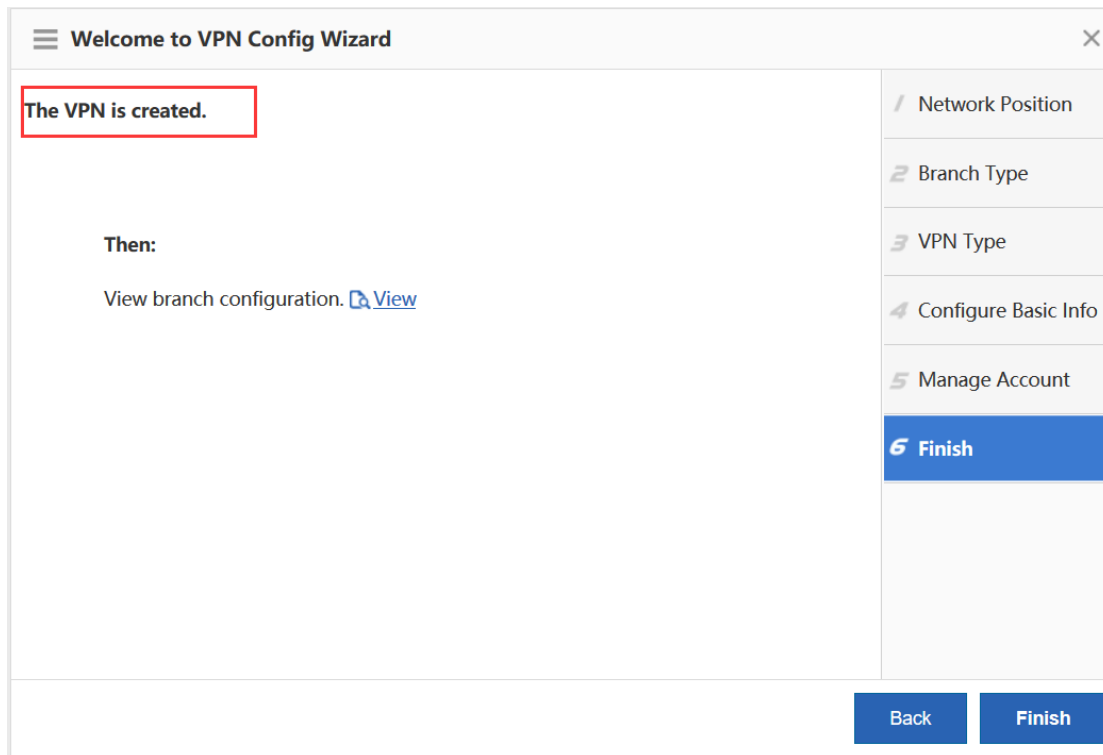

Configuration Verification

Connect the PC to the branch EG port Gi0/0, set the port IP address to 172.16.1.2/24, set the gateway IP address to 172.16.1.1, and select the local DNS. The Baidu page can be opened.

5.18.3.1.2 Configuration of the Headquarters Core Switch

Network Topology

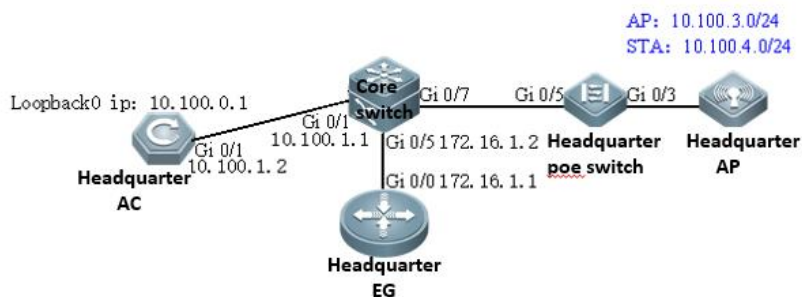

Networking Requirements

Gateways and DHCP address pools of the AP and STA are deployed on the core switch. The AP resides on VLAN 3, and the STA resides on VLAN 4. The IP address of the AP gateway is 10.100.3.1, and the IP address of the STA gateway is 10.100.4.1.

The loopback IP address of the headquarters AC is 10.100.0.1. The IP address of the headquarters core switch port Gi0/5 is 172.16.1.2, the IP address of Gi0/1 is 10.100.1.1, and the IP address of Gi0/3 is 10.100.2.1.

Configuration Steps:

Configure the DHCP address pool.

```
service dhcp
!
ip dhcp pool ap_vlan3    //Indicates the headquarters AP address pool.
option 138 ip 10.100.0.1
network 10.100.3.0 255.255.255.0 10.100.3.10 10.100.3.254
default-router 10.100.3.1
!
ip dhcp pool sta_vlan4  //Indicates the headquarters STA address pool.
network 10.100.4.0 255.255.255.0 10.100.4.10 10.100.4.254
dns-server 192.168.58.110
default-router 10.100.4.1
```

Configure ports, VLANs, and IP addresses.

```
vlan range 1,3,4    // VLAN 3 corresponds to the AP, and VLAN 4 corresponds to the STA.
!
interface GigabitEthernet 0/1    //Connects the headquarters AC.
no switchport
ip address 10.100.1.1 255.255.255.0
!
interface GigabitEthernet 0/5    //Connects the headquarters EG.
no switchport
ip address 172.16.1.2 255.255.255.0
!
interface GigabitEthernet 0/7    =====> Connects the PoE switch.
```

```
switchport mode trunk
```

```
switchport trunk native vlan 3
```

```
!
```

```
interface VLAN 3          =====> Indicates the headquarters AP gateway.
```

```
ip address 10.100.3.1 255.255.255.0
```

```
!
```

```
interface VLAN 4          =====>Indicates the headquarters STA gateway.
```

```
ip address 10.100.4.1 255.255.255.0
```

```
!
```

Configure the route.

```
ip route 10.100.0.1 255.255.255.255 10.100.1.2   =====>Directs the route to the headquarters AC.
```

```
ip route 0.0.0.0 0.0.0.0 172.16.1.1             =====>Directs the route to the headquarters EG.
```

Configuration Verification

The large-scale network 192.168.197.1 can be pinged from the headquarters core switch.

5.18.3.1.3 Configuration of the Headquarters PoE Switch

Network Topology

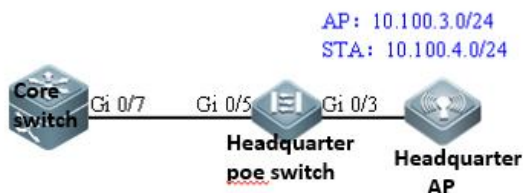

Networking Requirements

The AP resides on VLAN 3, and the STA resides on VLAN 4.

Configuration Steps

Configure ports, VLANs, and IP addresses.

```
vlan range 1,3,4          =====>VLAN 3 corresponds to the AP, and VLAN 4 corresponds to the STA.
```

```
!
```

```
interface GigabitEthernet 0/3 =====> Connects the headquarters AP.
```

```
switchport mode trunk
```

```
switchport trunk native vlan 3
```

```
switchport trunk allowed vlan only 3-4
```

```
poe enable
```

```
interface GigabitEthernet 0/5 =====>Connects the headquarters core switch.
```

```
switchport mode trunk
```

```
switchport trunk native vlan 3
```

```
switchport trunk allowed vlan only 3-4
```

```
poe enable
```

Configuration Verification

Show vlan :

```
ruijie# show vlan
```

VLAN Name	Status	Ports

3 VLAN03	STATIC	Gi0/3, Gi0/5
4 VLAN04	STATIC	Gi0/3, Gi0/5

5.18.3.1.4 Configuration of the Headquarters AC

Network Topology

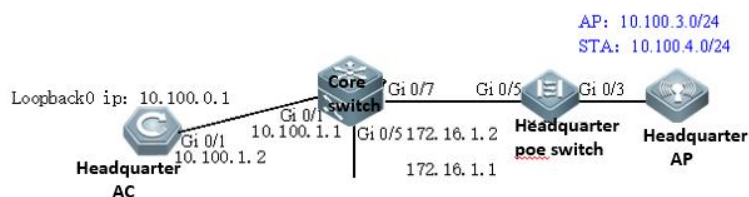

Networking Requirements

Set the IP address of Gi0/1 to 10.100.1.2. Configure the default route and direct the next hop to 10.100.1.1.

The loopback IP address of the branch AC is 10.100.0.1. Configuring the wireless network: The SSID is `wifi_test`, the ap-group name is **Headquarters**, the AP resides on VLAN 3, and the STA resides on VLAN 4.

Configuration Tips

By default, the Web service is enabled on the AC, the login IP address is 192.168.110.1, and the user name and password are **admin**. You can connect the PC to any port.

Configuration Steps

Set the IP address of Gi0/1 to 10.100.1.2.



Access Control

Wireless Control, Communication
Everywhere

IE8/9/10/11, Google Chrome, and 360 browsers are supported

Login

[Forget your password?](#)

[Simplified Chinese](#) |

Port	Link Status	Admin Status	Description	Information
Gi0/1	Down	Up	link to core switch	
Gi0/2	Up	Up		
Gi0/3	Up	Up		
Gi0/4	Down	Up		
Gi0/5	Down	Up		
Gi0/6	Down	Up		
Gi0/7	Down	Up		
Gi0/8	Down	Up		

Show No.: 10 Total Count:8

Edit Port Gi0/1

Admin State:

IPv4:

Mask:

Description:

[»» Advanced Settings](#)

Configure the default route and direct the next hop to 10.100.1.1.

Ruijie AC eWEB Model: WS6008 Detail

Route Settings

Note: Route selection points based routing and a backup route when the primary route does not take effect, it will take a backup route to the 2.

+ Add Static Route + Add Default Route X Delete Selected Route

<input type="checkbox"/>	Destination Subnet	Subnet Mask	Next Hop Address	Egress
<input type="checkbox"/>	0.0.0.0	0.0.0.0	192.168.60.1	

Show No.: 10 Total Count:1

Add Static Route

IP Type: IPv4 IPv6

Destination Subnet: 0.0.0.0 *

Subnet Mask: 0.0.0.0 *

Egress Port: Select Port v

Next Hop Address: 10.100.1.1 *

Routing: Primary Route v ?

Save cancel

Configure the wireless network.

Ruijie AC eWEB Model: WS6008 Detail [Quick Settings](#) [Online Service](#)

Route Settings

Note: Route selection points based routing and a backup route when the primary route does not take effect, it will take a backup route to the backup route in accordance with the priority level configured to go, than a backup route to the 2.

+ Add Static Route + Add Default Route X Delete Selected Route

<input type="checkbox"/>	Destination Subnet	Subnet Mask	Next Hop Address	Egress Port	Routing	Type
<input type="checkbox"/>	0.0.0.0	0.0.0.0	192.168.60.1		Primary Route	Default Route

Show No.: 10 Total Count:1 First Pre 1

Ruijie AC **Topology Confirmation**

AC connects with APs via switch
 AC connects with APs directly

AC-AP Interconnection

The configuration items in this step are not displayed unless configured through EWeb wizard. If you have configured AC-AP interconnection in other ways, skip this step.

Tunnel Port: Double click the port and then you can configure the ports.

Gi0/1
Gi0/2
Gi0/3
Gi0/4
Gi0/5
Gi0/6
Gi0/7
Gi0/8

Power on
 Non configurable
 configured

Tunnel IP:

Tunnel VLAN ID:

AP Network Configuration: DHCP:

[Back](#) [Next](#)

WiFi/WLAN Configuration

Wlan Id: * Range(1-2048)

SSID:

Encryption Type: No Encryption ?

Advanced Settings

Packet Forwarding: Central Forwarding Local Forwarding ?

SSID code: utf-8 gbk

Hide SSID:

Max STA Count:

Network OFF Period:

Network Access Configuration

Associated AP Group ?	STA VLAN ID ?	STA DHCP Service ?	Network Type	Support
Default	50	Configured on switch/gateway	2.4G&5G	

AP Settings

Note: Traffic refers to the sum of LAN port traffic in the CAPWAP tunnel, including STA and AP traffic.

Group Name-based Filter

AP Group Name: All AP Groups

AP Group List

- [-] All AP Groups
 - [-] Default

<input type="checkbox"/>	AP Name	IP	MAC	Loc
<input type="checkbox"/>	AP720-I	192.168.40.2	0074.9c5b.1fa3	
<input type="checkbox"/>	AP740-I	192.168.90.2	0074.9c9d.c677	
<input type="checkbox"/>	0074.9c9d.c485	-	0074.9c9d.c485	

Show No.: Total Count:3

Add AP Group

AP Group Name: *

Member AP:

[Save](#) [Cancel](#)

AP Settings

Note: Traffic refers to the sum of LAN port traffic in the CAPWAP tunnel, including STA and AP traffic.

GroupName-based Filter [Search](#) [Reset](#) **AP Group Name: local**

[AP Group](#) [On](#) [Off](#) [More](#)

<input type="checkbox"/>	AP Name	Location
		No F

Show No.: Total Count:0

AP Group List [Add Group](#) [Import AP](#)

- All AP Groups
 - Default [✎](#)
 - local [✎](#) [✕](#)

[Add AP](#)
[Delete AP](#)

[Restart AP](#)
[Restore Factory Settings](#)

☰ Add AP
✕

AP Name: *

MAC: *

Location:

▼
Advanced Settings

AP Group: ▼

Telnet Account:

Telnet Password: Show Password

Tunnel IP: ?

Save
Cancel

☰ Network Access Configuration
✕

Associated AP Group ?	STA VLAN ID ?	STA DHCP Service ?	Network Type	Support Radio ?	Action
<input type="text" value="local"/>	<input type="text" value="4"/>	<input type="text" value="Configured on switch/gateway"/>	<input type="text" value="2.4G&5G"/>	<input type="text"/>	✕ +Add

Back
Finish

Configuration Verification

The mobile phone can be associated with the SSID wifi_test and can be connected to networks after being associated.

5.18.3.2 Deployment of Basic Networks in DHCP Mode for Branches

After basic networks are deployed for branches, the branches can access the Internet. Deployment of basic networks for branches is not related to smart APs so that the networks can be deployed in traditional mode. However, deployment of smart APs is based on deployment of basic networks for branches.

5.18.3.2.1 Configuration of Network Access Through the Branch EG

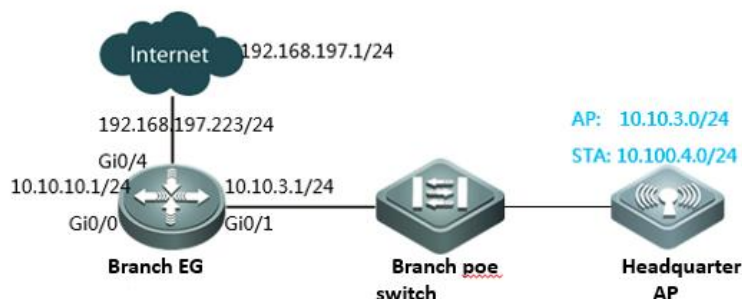

Networking Requirements

As a network egress, EG is connected to networks through a static IP address. The gateway for LAN users resides on the EG LAN port. You need to configure EG to access networks.

The WAN bandwidth is 10 Mbps, the IP address of the WAN port is 192.168.197.223/24 (an IP address for tests and simulations, not the real carrier IP address), the IP address of the WAN gateway is 192.168.197.1, and the IP address of the LAN port is 10.10.3.1/24.

Configuration Tips

Confirm information on the WAN (for example, the IP address provided by the carrier) as well as the LAN and WAN ports (for example, the LAN port and WAN port of RG-EG2000K are marked with "LAN" and "WAN", respectively).

To connect a new EG to networks, start quick configuration. By default, the login IP address is 192.168.1.1, the user name and password are **admin**, and the LAN port ID is Gi0/0.

On the **Advanced** page, select **Enable NAT** and **Enable Route**, and configure the DNS.

Note: As the LAN is a private network, you need to enable NAT and routing to access the network. As a necessary parameter for system file updating and detection, the DNS must be configured.

Configuration Steps

Enter the IP address of the EG LAN port (default IP address: 192.168.1.1; default user name/password: **admin/admin**) and log in to the router configuration page.



EasyGate





Multi-Function , Easy Management , Low Cost

Internet Explorer 10/11, Google Chrome, Firefox Recommended

[Forgot password?](#)

Quick Configuration

Setup Wizard

1 Network Mode

 Gateway

 Bridge
2 Interface
LAN Interface: Gi0/0 Gi0/1 Gi0/3 Gi0/4 Gi0/5
Gi0/0: -
WAN Interface: Gi0/2 Gi0/6 Gi0/7 
Gi0/6: - Mbps
 - -

3 **Advanced** ▾

NAT: Enable

Route: Enable

Access Security: Shield Invalid/Virus Websites

DNS Server: If no available DNS is configured, remote upgrade may fail.

Web Access Port: (80, 1025 to 65535) Tip: Ensure that the port is not occupied and is not shielded.

Finish
Homepage

Note: As the IP address of Gi0/0 is changed from 192.168.1.1 to 10.10.3.1, you need to change the eWeb login IP address to 10.10.3.1.

Configuration Verification

Connect the PC to the branch EG port Gi0/0, set the port IP address to 10.10.1.2/24, set the gateway IP address to 10.10.1.1, and select the local DNS. The Baidu page can be opened.

5.18.3.2.2 Configuration of Branch EG Routes/DHCP

Network Topology

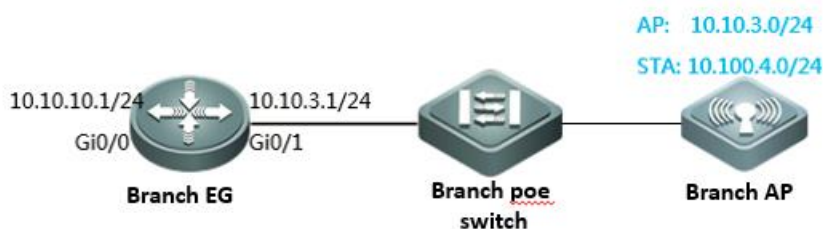

Networking Requirements

The AP gateway is deployed on the branch EG. The gateway IP address is 10.10.3.1. The AP resides on VLAN 3. The AP address pool is deployed on the branch EG.

Configuration Steps

Configure the IP address of the LAN port.

The screenshot shows the Ruijie eWEB Administrator interface. On the left is a navigation menu with categories: Home, Flow, Security, User, Network, and Advanced. The 'Network' category is selected, and the 'Interface' sub-menu is active. The main content area is titled 'LAN PortConfig Sub Interface' and has a red box around it. It contains a 'Basic Settings' tab and a note: 'Note: Click the corresponding interface to edit configuration. AnyIP: A successful gateway spoofing (ARP spoofing) attack allows an attacker to alter network directly.' Below the note are icons for WAN Ports (2, 6, 7) and LAN Ports (0, 1, 3, 4, 5). A legend indicates that a green square icon means 'Power-on' and a grey square icon means 'Power-off'. The LAN Port 1 icon is highlighted with a blue border, and the 'Sub Interface' text in the title is highlighted with a red box.

Sub Interface: . * (Range: 1-1023)

VLAN ID: * (Range: 1-4087)

IP Address: *

Submask: *

AnyIP: Enable

Reverse Path Limited: Enable

Configure the AP address pool.

The screenshot displays the Ruijie EG eWEB Administrator interface. The top left corner features the 'Ruijie EG' logo. The top right corner shows the user 'Administrator: admin'. A navigation sidebar on the left includes icons and labels for Home, Flow, Security, User, Network, and Advanced. The main content area has a top navigation bar with 'Settings', 'Static IP Address', and 'User List' tabs. The 'Settings' tab is active, and a red box highlights the 'DHCP: OFF' toggle switch.

Settings	Static IP Address	User List
----------	-------------------	-----------

DHCP: OFF

The screenshot shows the Ruijie eWEB Administrator interface. The top left features the Ruijie EG logo and the user 'admin'. A left sidebar contains navigation icons for Home, Flow, Security, User, Network, and Advanced. The main content area is titled 'Interface' and includes tabs for 'Settings', 'Static IP Address', and 'User List'. Under the 'Settings' tab, there are buttons for '+ Add DHCP', 'Delete Selected DHCP', and 'Excluded Address Range'. Below these is a table with columns for 'Name' and 'IP Address Range'. At the bottom of the table area, there is a 'Show No.' dropdown set to '10' and a 'Total Count:0' indicator.

The 'Add DHCP' dialog box is shown with the following fields and values:

- Subnet: 10.10.3.0 * Format: 192.168.1.0
- Mask: 255.255.255.0 * Format: 255.255.255.0
- Default Gateway: 10.10.3.1 * Format: 192.168.1.1
- Lease Time: Permanent Lease Time [] d [] h [] min *
- Preferred DNS Server: 192.168.58.110 * Format: 114.114.114.114
- Secondary DNS Server: 192.168.58.111
- Option 43: [] ?
- Option 138: 10.10.0.1 ?

At the bottom right, there are 'Save' and 'Cancel' buttons, with the 'Save' button highlighted by a red box.

5.18.3.2.3 Configuration of Branch PoE Switches

Network Topology

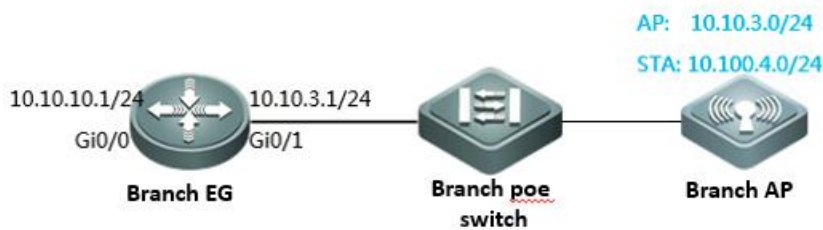

Networking Requirements

AP resides on VLAN 3.

Configuration Steps

Configure ports and VLANs.

vlan range 1,3,4 =====>VLAN 3 corresponds to the AP.

!

interface GigabitEthernet 0/7 =====>Connects the branch AP.

switchport mode trunk

switchport trunk native vlan 3

switchport trunk allowed vlan only 3

poE enable

interface GigabitEthernet 0/5 =====>Connects the branch EG.

switchport mode trunk

switchport trunk allowed vlan only 3

poE enable

Configuration Verification

show vlan :

```
ruijie# show vlan
```

VLAN Name	Status	Ports
3 VLAN03	STATIC	Gi0/5, Gi0/7

5.18.3.2.4 Configuration of Branch APs

Configuration Steps

Connect the PC to the AP, set a PC IP address to that of the 192.168.110.0/24 network segment, for example, 192.168.110.10.

Log in to the AP Web page and enter the AP IP address (192.168.110.1 by default), as shown in the following figure.



Access Point
Wireless Control, Communication
Everywhere

IE8/9/10/11, Google Chrome, and 360 browsers are supported

Please enter the administrator username

Please enter the administrator password

Login

[Forget your password?](#) [Simplified Chinese](#) ▾

Enter the user name **admin** and password **admin**, and click **Login**, as shown in the following figure.

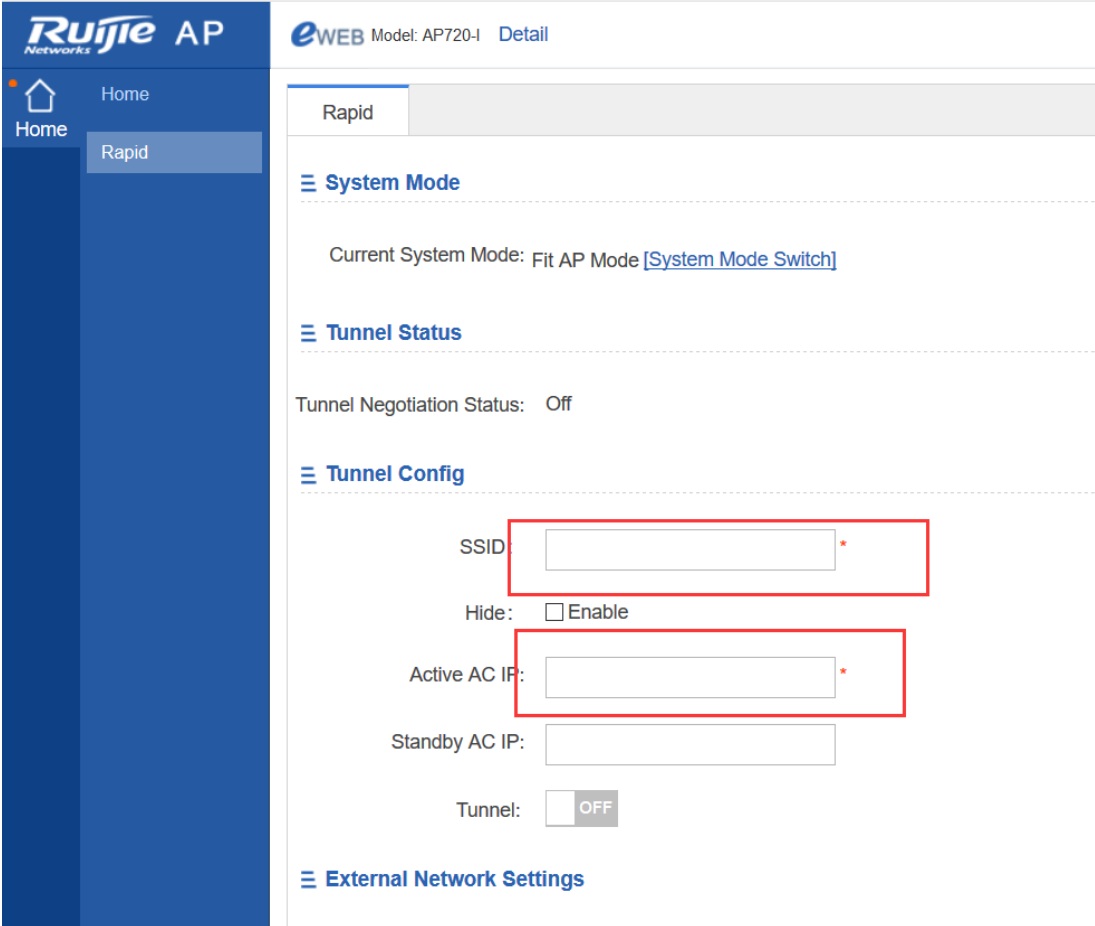

The screenshot displays the Ruijie AP eWEB configuration interface. The left sidebar shows the 'Rapid' configuration mode selected. The main content area is titled 'Rapid' and includes sections for 'System Mode', 'Tunnel Status', and 'Tunnel Config'. In the 'Tunnel Config' section, the 'SSID' and 'Active AC IP' input fields are highlighted with red boxes. The 'Tunnel' switch is currently set to 'OFF'.

Ruijie AP eWEB Model: AP720-I Detail

Home Rapid

System Mode

Current System Mode: Fit AP Mode [\[System Mode Switch\]](#)

Tunnel Status

Tunnel Negotiation Status: Off

Tunnel Config

SSID: *

Hide: Enable

Active AC IP: *

Standby AC IP:

Tunnel: OFF

External Network Settings

Tunnel Configuration

Configure the SSID and active AP IP address, turn the **Tunnel** switch to **ON** position, enter the headquarters IP address, click **Yes** for **Access AC Through**, and enter the user name or password (if no user name or password has been set, use the serial number as the user name and password), as shown in the following figure.

≡ Tunnel Config

SSID: *Please connect to WiFi " ap520" and then access Wet

Hide: Enable

Active AC IP: *

Standby AC IP:

Tunnel: ON

HQ IP: *

Access AC Through Yes No

Tunnel:

⌵ Advanced Settings

Username:

Password:

MTU:

AP Flag: Open

Flag Name:

WAN Settings

Select **DHCP (Dynamic IP)** as an Internet connection type, as shown in the following figure.

≡ External Network Settings

Internet Connection Type:

Click **Save**.

Connect the LAN cable to the DHCP server.

Configuration Verification

The mobile phone can be associated with the SSID wifi_test and can be connected to networks after being associated.

5.18.3.3 Deployment of Basic Networks in PPPoE Mode for Branches

5.18.3.3.1 Configuration of Branch APs

Configuration Steps

Connect the PC to the AP and set the Network Interface Card (NIC) IP address to 192.168.110.10.

Log in to the AP Web page and enter 192.168.110.1, as shown in the following figure.

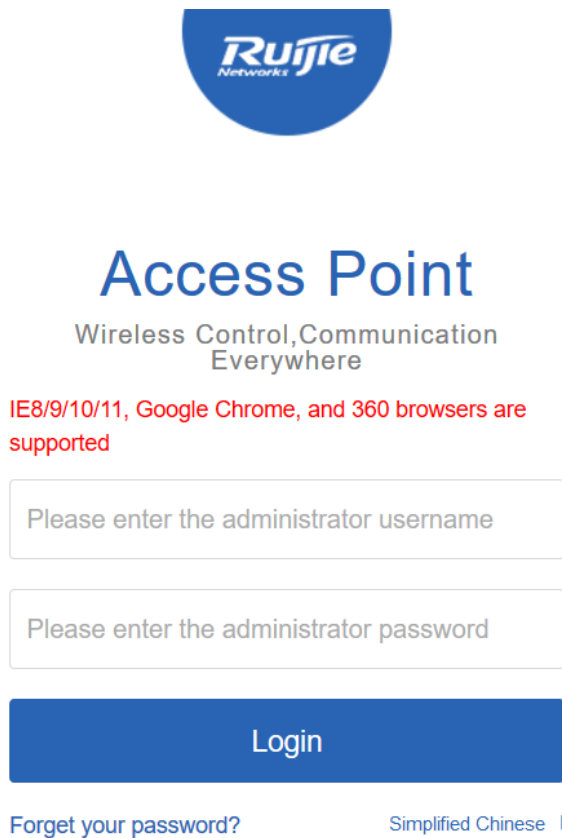

The screenshot shows the Ruijie Access Point web interface. At the top is the Ruijie Networks logo. Below it, the title "Access Point" is displayed in a large blue font, followed by the tagline "Wireless Control, Communication Everywhere". A red notice states: "IE8/9/10/11, Google Chrome, and 360 browsers are supported". There are two input fields: "Please enter the administrator username" and "Please enter the administrator password". Below these is a blue "Login" button. At the bottom, there are links for "Forget your password?" and "Simplified Chinese" with a dropdown arrow.

Enter the user name **admin** and password **admin**, and click **Login**, as shown in the following figure.

The screenshot shows the Ruijie AP eWEB configuration interface. The top left corner displays the Ruijie AP logo and the model number AP720-I. The left sidebar contains navigation options: Home and Rapid. The main content area is titled 'Rapid' and includes the following sections:

- System Mode:** Current System Mode: Fit AP Mode [System Mode Switch]
- Tunnel Status:** Tunnel Negotiation Status: Off
- Tunnel Config:**
 - SSID: [Text Input Field] *
 - Hide: Enable
 - Active AC IP: [Text Input Field] *
 - Standby AC IP: [Text Input Field]
 - Tunnel: OFF
- External Network Settings:**

Tunnel Configuration

Configure the SSID and active AP IP address, turn the **Tunnel** switch to **ON** position, enter the headquarters IP address, click **Yes** for **Access AC Through**, and enter the user name or password (if no user name or password has been set, use the serial number as the user name and password), as shown in the following figure.

≡ Tunnel Config

SSID: *Please connect to WiFi " ap520" and then access Web

Hide: Enable

Active AC IP: *

Standby AC IP:

Tunnel: ON

HQ IP: *

Access AC Through Yes No

Tunnel:

⌵ Advanced Settings

Username:

Password:

MTU:

AP Flag: Open

Flag Name:

WAN Settings

Select **PPPoE (ADSL Line)** as an Internet connection type, as shown in the following figure.

≡ External Network Settings

Internet Connection Type:

Account: *

Password: *

Enter the account and password, and click **Save**.

Connect the egress cable to the PPPoE server.

Configuration Verification

The mobile phone can be associated with the SSID wifi_test and can be connected to networks after being associated.

5.18.3.4 Deployment of Basic Networks in Static Mode for Branches

5.18.3.4.1 Configuration of Branch APs

Configuration Steps

Connect the PC to the AP and set the NIC IP address to 192.168.110.10.

Log in to the AP Web page and enter 192.168.110.1, as shown in the following figure.

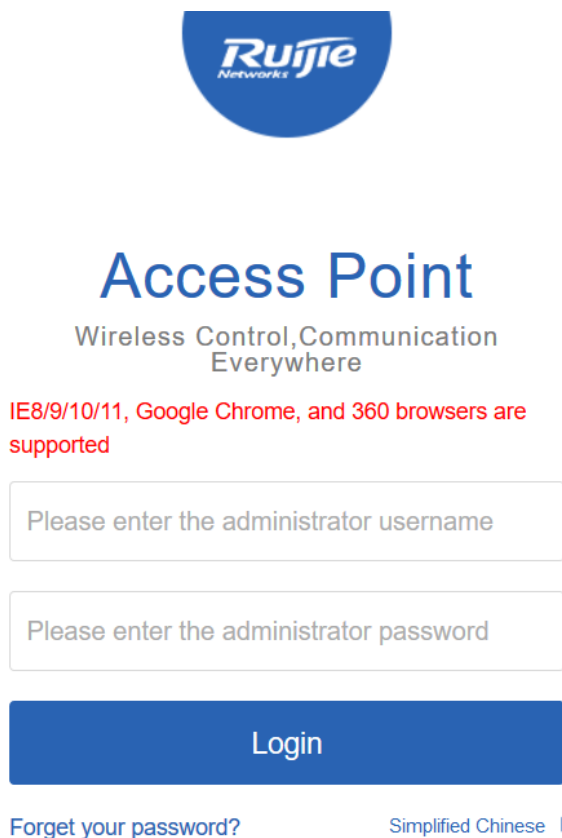

Ruijie
Networks

Access Point

Wireless Control, Communication
Everywhere

IE8/9/10/11, Google Chrome, and 360 browsers are supported

Please enter the administrator username

Please enter the administrator password

Login

[Forgot your password?](#) [Simplified Chinese](#) |

Enter the user name **admin** and password **admin**, and click **Login**, as shown in the following figure.

The screenshot shows the Ruijie AP eWEB configuration interface. The left sidebar contains the 'Ruijie AP' logo and navigation links for 'Home' and 'Rapid'. The main content area is titled 'Rapid' and includes sections for 'System Mode', 'Tunnel Status', and 'Tunnel Config'. The 'Tunnel Config' section contains the following fields:

- SSID: *
- Hide: Enable
- Active AC IP: *
- Standby AC IP:
- Tunnel: OFF

Below the 'Tunnel Config' section is the 'External Network Settings' section.

Tunnel Configuration

Configure the SSID and active AP IP address, turn the **Tunnel** switch to **ON** position, enter the headquarters IP address, click **Yes** for **Access AC Through**, and enter the user name or password (if no user name or password has been set, use the serial number as the user name and password), as shown in the following figure.

≡ Tunnel Config

SSID: *Please connect to WiFi "ap520" and then access Web

Hide: Enable

Active AC IP: *

Standby AC IP:

Tunnel: ON

HQ IP: *

Access AC Through Yes No

Tunnel:

⌵ Advanced Settings

Username:

Password:

MTU:

AP Flag: Open

Flag Name:

Note: When networks are deployed through static IP addresses, select **IP-Based** rather than **DNS-Based** for the headquarters IP address.

WAN Settings

Select **Static IP (Dedicated IP)** as an Internet connection type, as shown in the following figure.

三 外网设置

联网类型：

IP地址： *

子网掩码： *

AP网关地址： *

Enter the IP address, subnet mask, and AP gateway address. Click **Save**.

Connect the egress cable to WANs.

Configuration Verification

The mobile phone can be associated with the SSID wifi_test and can be connected to networks after being associated.

6 Solutions

6.1 Bring Your Own Device (BYOD)

6.1.1 Understanding BYOD



“Bring Your Own Device means the policy of permitting individuals to bring personally owned mobile devices to their work place, and use to access privileged company information and applications.”-source from Wikipedia

Not like traditional WLAN authentication, BYOD does not require wireless users install specific authentication clients, in this case BYOD has a good compatibility for more and more mobile and laptop devices.

Ruijie offers a comprehensive solution to address an extensive array of BYOD requirements and challenges such as wireless coverage, access control and unified management. The architecture design of the solution is as follows:

1. Wireless coverage:

X-Sense and i-Share wireless coverage solution

802.11n and 802.11ac Gigabit WiFi

Simultaneously manage at least 200 wireless access points (APs)

2. Access control:

Seamless staff wireless authentication

Role-based network access control

Self-service Email/SMS guest account management

Unique QR code guest authentication

3. Unified management:

Visualization management of wireless device and remote fault location

Unified management of wired, wireless and Virtual Private Network (VPN) users

Integration with Identity Management System (e.g. LDAP, Microsoft AD)

Proactive alert management via Email / SMS

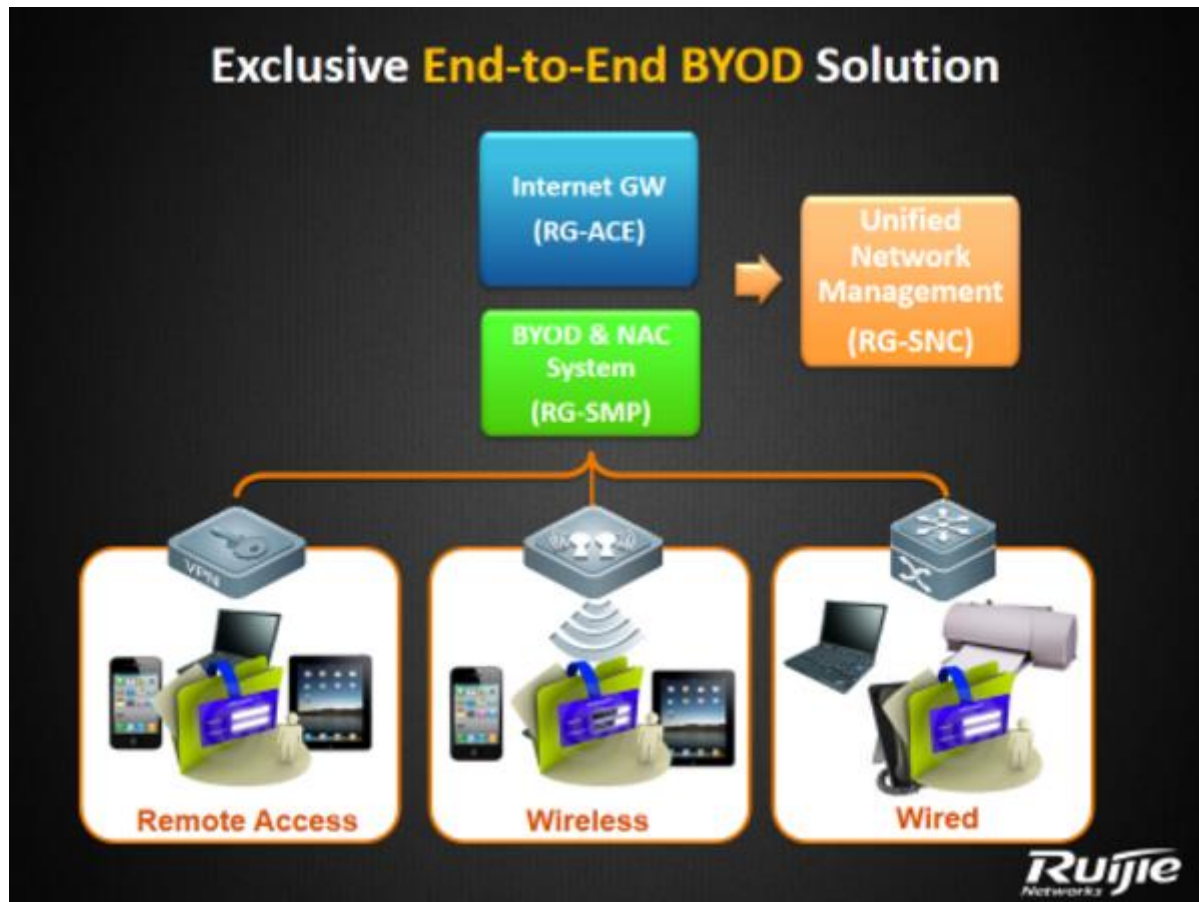

6.1.2 Configuring BYOD

BYOD Components

In BYOD Scenario, besides basic network infrastructures, following components are required: SMP Server, Wireless Controller and Access Point.

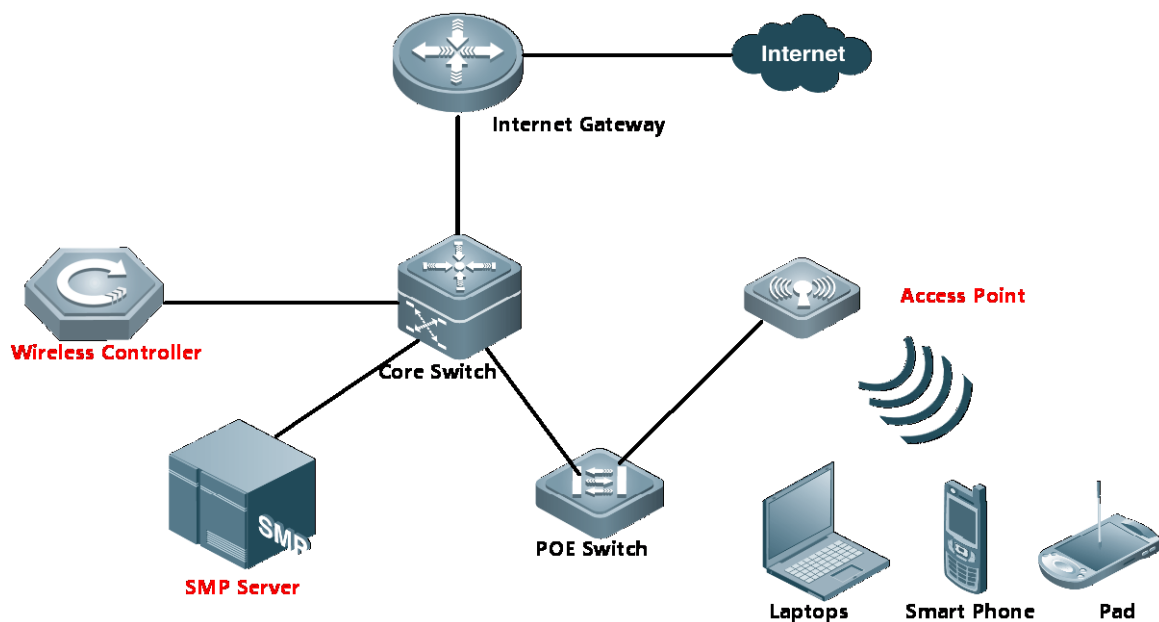

BYOD Solution for Staffs No.1: 802.1x Seamless Authentication

Step 1: connects one wireless equipment to SSID “802.1x”, fill in username and password. In several seconds, equipment passes authentication, then you can start surfing Internet.

Step 2: Bring the equipment out of wireless coverage, then wireless network interrupts.

Step 3: Bring the authenticated equipment back into the wireless coverage, then this equipment will pass the authentication automatically at the back end, and no more manual intervention is required before you start surfing Internet.

BYOD Solution for Staffs No.2: Web Seamless Authentication

Step 1: connects one wireless equipment to SSID “WebAuth”, authentication portal pops up automatically soon. Fill in username and password. In several seconds, equipment passes authentication, then you can start surfing Internet.

Step 2: Bring the equipment out of wireless coverage, then wireless network interrupts.

Step 3: Bring the authenticated equipment back into the wireless coverage, then this equipment will pass the authentication automatically at the back end, and no more manual intervention is required before you start surfing Internet.

BYOD Solution for Visitors No.3: QRCode Authentication

Step 1: Staff passes “802.1x” or “WebAuth” authentication first

Step 2: Visitors connects to SSID “Visitors”, authentication portal pops up automatically soon, displaying a QRCode Diagram.

Step 3: Staff scans the QR Code, and set the validation period for this temple account (1 day at most).

Step 4: Visitors passes authentication and start surfing.

BYOD Solution for Visitors No.4: SMS Registration Authentication

Step 1: Visitors connects to SSID "Visitors-AUTO", authentication portal pops up automatically soon.

Step 2: Choose Tab "Visitors Authentication" and fill in the phone number, then click "Acquire sms password"

Step 3: A SMS including password will send to the specified number soon.

Step 4: Visitors fill in the password on authentication portal, then start surfing the Internet

6.1.2.1 802.1x Seamless Authentication

Overview

Understanding 802.1x Seamless Authentication

Step 1: connects one wireless equipment to SSID "802.1x", fill in username and password. In several seconds, equipment passes authentication, then you can start surfing Internet.

Step 2: Bring the equipment out of wireless coverage, then wireless network interrupts.

Step 3: Bring the authenticated equipment back into the wireless coverage, then this equipment will pass the authentication automatically at the back end, and no more manual intervention is required before you start surfing Internet.

I. Network Topology

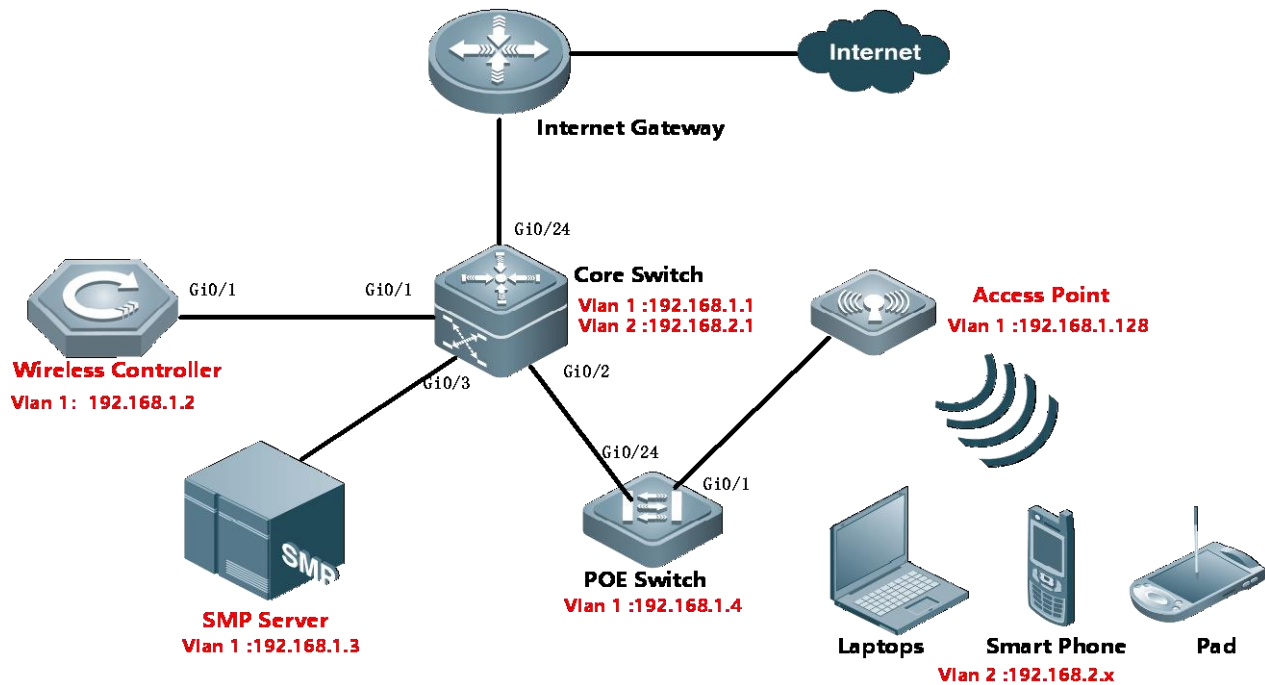

II. Configuration Tips

Configuring Network Infrastructures

1. Finish configuring Internet gateway, Core switch and POE Switch including Vlan 1&2 creation, IP assignment and others required.
2. All wired&wireless devices point gateway to Core Switch.

III. Configuration Steps

On AC:

```

vlan 1
vlan 2
interface gi0/1
description Link-to-CoreSwitch
switchport mode trunk
switchport trunk allowed vlan remove 3-4094
interface vlan 1
ip address 192.168.1.2 255.255.255.0
interface loopback 0
ip address 1.1.1.1 255.255.255.255

```



```

ip route 0.0.0.0 0.0.0.0 192.168.1.1

service dhcp

ip dhcp pool ForAP

network 192.168.1.0 255.255.255.0 192.168.1.128 192.168.1.200

option 138 ip 1.1.1.1

default-router 192.168.1.1

dns-server 8.8.8.8

ip dhcp pool ForUsers

network 192.168.2.0 255.255.255.0

default-router 192.168.2.1

dns-server 8.8.8.8

aaa new-model

aaa group server radius smp

server 192.168.1.3

radius-server host 192.168.1.3 key ruijie

aaa accounting update

aaa accounting update periodic 5

snmp-server enable traps

snmp-server community ruijie rw

ip dhcp snooping

```

On SMP:

1. Go to Authentication & Authority > Device > Add

The screenshot displays the web management interface for the Ruijie SMP. The breadcrumb navigation is 'Authentication & Authority > Device > Query'. The left sidebar contains a menu with 'Device' highlighted. The main content area has search fields for 'NAS IP' and 'NAS Name', and a dropdown for 'NAS Configuration Templates' set to 'All'. There are 'Query' and 'Reset' buttons. Below these are buttons for 'Add', 'Delete', 'Search Device', 'Import Device', and 'Synchronize MAC'. The 'Add' button is highlighted with a red box. At the bottom, a status bar shows 'Totally 1 Records | Each Page 20 Records | Page 1 / totally 1 Pages | GO'.

Authentication & Authority > Device > Add

Basic Information

* NAS IP: (Format: 192.168.20.1)

* NAS Configuration Templates: [Obtain Device Information](#) | [View Template](#) | [Add Template](#)

NAS MAC: (Format: 00D0F8000001)

NAS Name:

NAS Location:

NAS Information:

2. Fill in the NAS IP and Choose “Ruijie Wireless device”in the drop-down list. System will prompt “obtaining device information and return a failed message”. It doesn’t matter, because we haven’t set the correct template.

Basic Information

* NAS IP: (Format: 192.168.20.1)

* NAS Configuration Templates: [Obtain Device Information](#) | [View Template](#) | [Add Template](#)

NAS MAC: (Format: 00D0F8000001)

NAS Name:

NAS Location:

NAS Information:

Tips:
You can set a template for the devices sharing the same SNMP version, authentication and Telnet parameters.

Obtaining device information... Please wait.

Authentication & Authority > Device > Add

Basic Information

* NAS IP: (Format: 192.168.20.1)

* NAS Configuration Templates: [Obtain Device Information](#) | [View Template](#) | [Add Template](#)

NAS MAC: (Format: 00D0F8000001)

NAS Name:

NAS Location:

NAS Information:

Tips:
You can set a template for the devices sharing the same SNMP version, authentication and Telnet parameters.

3. Click “View Template”, a new windows pops up displaying current template information, then click “Modify”

Basic Information	
* NAS IP:	<input type="text" value="192.168.2.3"/> (Format: 192.168.20.1)
* NAS Configuration Templates:	<input type="text" value="Ruijie Wireless Device"/> <input type="button" value="Obtain Device Information"/> <input type="button" value="View Template"/> <input type="button" value="Add Template"/>
NAS MAC:	<input type="text"/> (Format: 00D0F8000001)
NAS Name:	<input type="text"/>
NAS Location:	<input type="text"/>
NAS Information:	<input type="text"/>

4. Follow below to set according fields:

Identity Authentication Key: ruijie

Web authentication Key : ruijie

SNMP v2c Community : ruijie

Authentication & Authority > Device > NAS Configuration Templates > Modify

Basic Information	
* Template Name:	<input type="text" value="Ruijie Wireless Device"/>
* Type:	<input type="text" value="Ruijie Wireless Device"/> <input type="button" value="v"/>

Identity Authentication Configuration	
* Identity Authentication Key:	<input type="text" value="ruijie"/>
<p> Tips: The system and devices perform user authentication via the Radius Protocol. Identity authentication key is used for the encryption of d should be the same as that of the devices.</p>	

Web Authentication Configuration	
Web authentication Key:	<input type="text" value="ruijie"/>
<p> Tips: After the Web authentication key is specified, the system will support Web authentication.</p>	

SNMP Configuration	
* SNMP v2c Community:	<input type="text" value="ruijie"/>
<p> Tips: The SNMP configuration should be the same as that on the devices. Otherwise the system cannot manage the devices.</p>	

Security Management	
Device based NAC:	<input type="radio"/> Supported <input checked="" type="radio"/> Unsupported

Tips:
You can set a template for the devices sharing the same SNMP version, authentication and Telnet parameters.

4. Click "Obtain Device information" again, device information is obtained successfully this time. Click "Add"

Authentication & Authority > Device > Modify

Basic Information

* NAS IP:

* NAS Configuration Templates: [Obtain Device Information](#) | [View Template](#) | [Add Template](#)

NAS MAC: (Format: 00D0F8000001)

NAS Name:

NAS Location:

NAS Information:

Tips:
You can set a template for the devices sharing the same SNMP version, authentication and Telnet parameters.

Configuring 802.1x Seamless Authentication

On AC:

```

aaa accounting network acct-1x start-stop group smp
aaa authentication dot1x auth-1x group smp
wlan-config 10 "802.1x"
ap-group default
interface-mapping 10 2
wlansec 10
security rsn enable
security rsn ciphers aes enable
security rsn akm 802.1x enable
dot1x authentication auth-1x
dot1x accounting acct-1x

```

On SMP:

Step 1: Configure 802.1x SSID and security parameters

Go to Authentication & Authority > Authentication Settings from the left menu. Enable PEAP Authentication for Windows Client. Fill in the "Auto-connect to SSID", the value must match with the SSID for 802.1x authentication defined on AC. Choose the Security Type, Encryption Type and Second Stage of PEAP Authentication based on requirement.



Step 2: Create a new account for testing

Go to Authentication & Authority > Users from the left menu. Add one account for testing purpose, and put this account in Default User Group

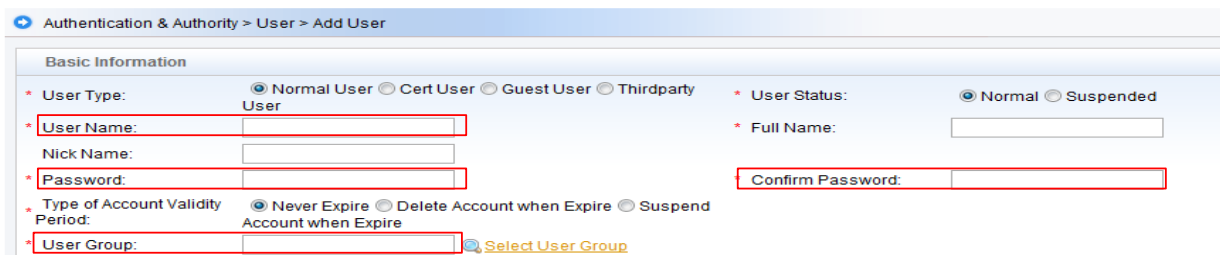

6.1.2.2 Web Seamless Authentication

Overview

Understanding Web Seamless Authentication

Step 1: connects one wireless equipment to SSID “webauth”, authentication portal pops up automatically soon. Fill in username and password. In several seconds, equipment passes authentication, then you can start surfing Internet.

Step 2: Bring the equipment out of wireless coverage, then wireless network interrupts.

Step 3: Bring the authenticated equipment back into the wireless coverage, then this equipment will pass the authentication automatically at the back end, and no more manual intervention is required before you start surfing Internet.

I. Network Topology

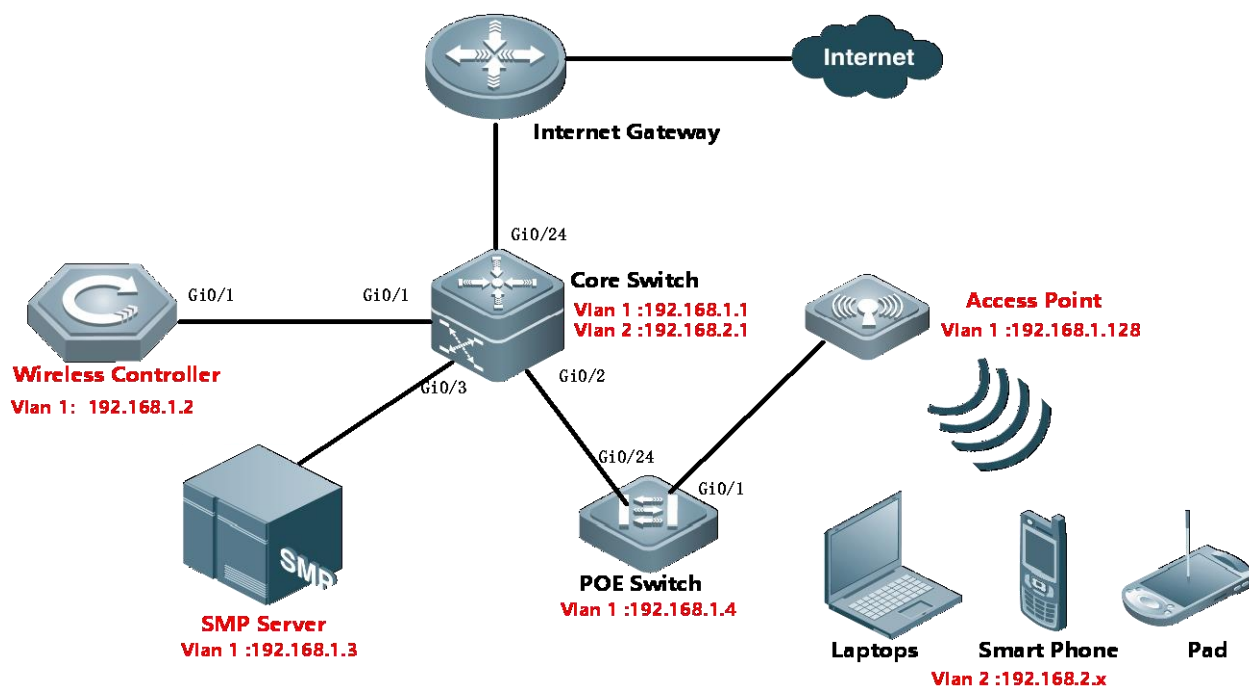

II. Configuration Tips

Configuring Network Infrastructures

1. Finish configuring Internet gateway, Core switch and POE Switch including Vlan 1&2 creation, IP assignment and others required.
2. All wired&wireless devices point gateway to Core Switch.

III. Configuration Steps

On AC:

```
vlan 1
vlan 2
```

```
interface gi0/1
description Link-to-CoreSwitch
switchport mode trunk
switchport trunk allowed vlan remove 3-4094

interface vlan 1
ip address 192.168.1.2 255.255.255.0

interface loopback 0
ip address 1.1.1.1 255.255.255.255

ip route 0.0.0.0 0.0.0.0 192.168.1.1
service dhcp
ip dhcp pool ForAP
network 192.168.1.0 255.255.255.0 192.168.1.128 192.168.1.200
option 138 ip 1.1.1.1
default-router 192.168.1.1
dns-server 8.8.8.8

ip dhcp pool ForUsers
network 192.168.2.0 255.255.255.0
default-router 192.168.2.1
dns-server 8.8.8.8
aaa new-model
aaa group server radius smp
server 192.168.1.3
radius-server host 192.168.1.3 key ruijie
aaa accounting update
aaa accounting update periodic 5
snmp-server enable traps
snmp-server community ruijie rw
ip dhcp snooping
dot1x valid-ip-acct enable
```

On SMP:

1. Go to Authentication & Authority > Device > Add

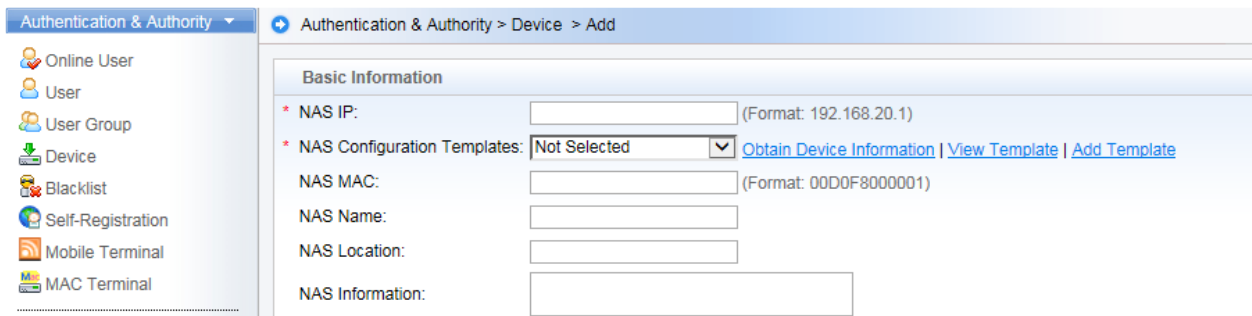
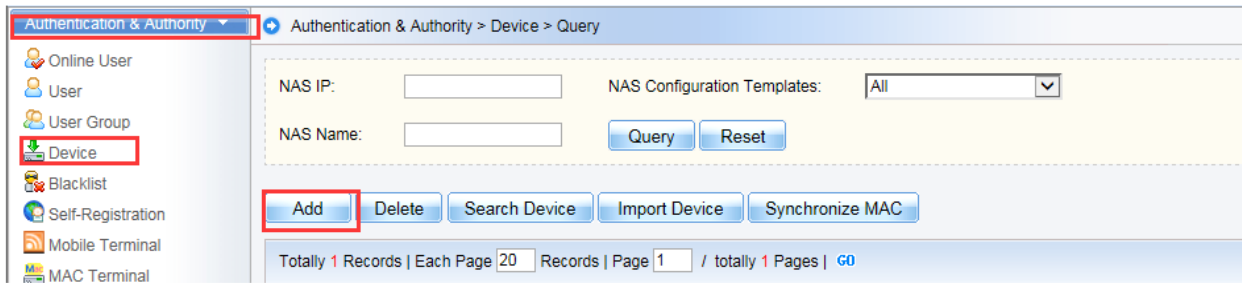

2. Fill in the NAS IP and Choose "Ruijie Wireless device" in the drop-down list. System will prompt "obtaining device information and return a failed message". It doesn't matter, because we haven't set the correct template.

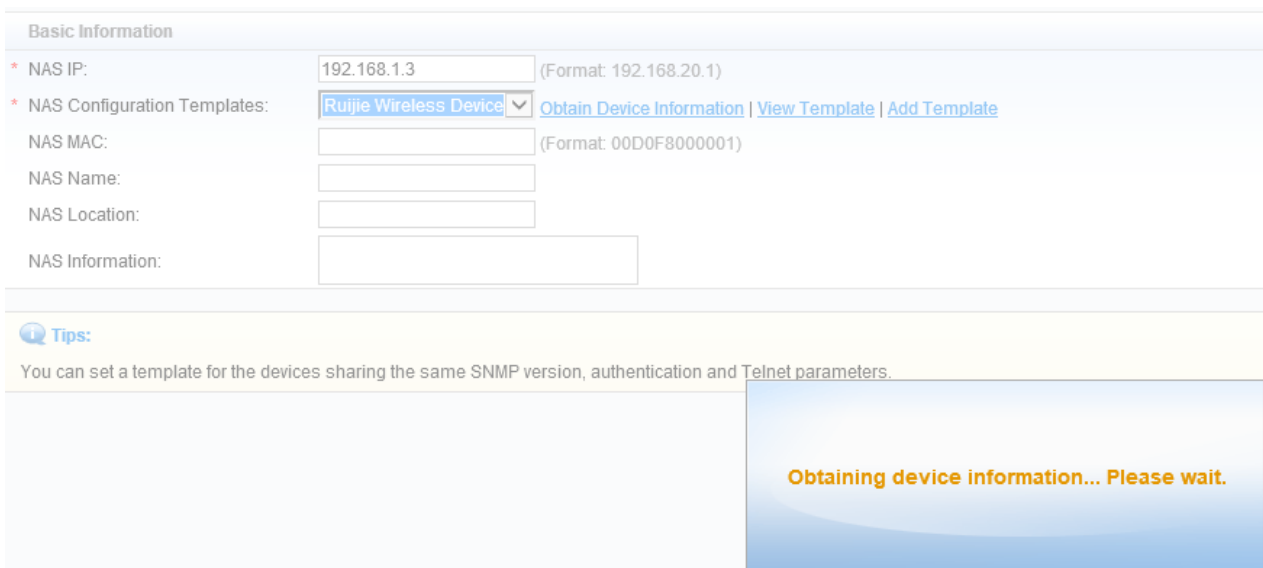

Authentication & Authority > Device > Add

Basic Information

* NAS IP: (Format: 192.168.20.1)

* NAS Configuration Templates: [Obtain Device Information](#) [View Template](#) [Add Template](#)

NAS MAC: (Format: 00D0F8000001)

NAS Name:

NAS Location:

NAS Information:

Tips:
You can set a template for the devices sharing the same SNMP version, authentication and Telnet parameters.

3. Click "View Template", a new windows pops up displaying current template information, then click "Modify"

Basic Information

* NAS IP: (Format: 192.168.20.1)

* NAS Configuration Templates: [Obtain Device Information](#) [View Template](#) [Add Template](#)

NAS MAC: (Format: 00D0F8000001)

NAS Name:

NAS Location:

NAS Information:

4. Follow below to set according fields:

Identity Authentication Key: ruijie
 Web authentication Key : ruijie
 SNMP v2c Community : ruijie

Authentication & Authority > Device > NAS Configuration Templates > Modify

Basic Information

* Template Name: * Type:

Identity Authentication Configuration

* Identity Authentication Key:

Tip: The system and devices perform user authentication via the Radius Protocol. Identity authentication key is used for the encryption of d should be the same as that of the devices.

Web Authentication Configuration

Web authentication Key:

Tip: After the Web authentication key is specified, the system will support Web authentication.

SNMP Configuration

* SNMP v2c Community:

Tip: The SNMP configuration should be the same as that on the devices. Otherwise the system cannot manage the devices.

Security Management

Device based NAC: Supported Unsupported

Tips:
You can set a template for the devices sharing the same SNMP version, authentication and Telnet parameters.

5. Click “Obtain Device information” again, device information is obtained successfully this time. Click “Add”

Authentication & Authority > Device > Modify

Basic Information

* NAS IP:

* NAS Configuration Templates: [Obtain Device Information](#) | [View Template](#) | [Add Template](#)

NAS MAC: (Format: 00D0F8000001)

NAS Name:

NAS Location:

NAS Information:

Tips:
You can set a template for the devices sharing the same SNMP version, authentication and Telnet parameters.

Configuring Web Seamless Authentication

```
aaa accounting network acct-1x start-stop group smp
```

```
aaa authentication dot1x auth-1x group smp
aaa accounting network acct-web start-stop group smp
aaa authentication web-auth auth-web group smp

wlan-config 20 "Ruijie Web Auth"
  enable-broad-ssid

ap-group default
interface-mapping 20 2

web-auth template webauth v2
  ip 192.168.1.3
  url http://192.168.1.3:80/smp/commonauth
wlansec 20
  web-auth authentication v2 auth-web
  web-auth accounting v2 acct-web
  web-auth portal webauth
  dot1x authentication auth-1x
  dot1x accounting acct-1x
  dot1x-mab
  webauth

web-auth portal key ruijie
radius-server attribute 31 mac format ietf
snmp-server community ruijie rw
snmp-server enable traps
http redirect direct-site 192.168.2.1 arp

ip dhcp snooping
dot1x valid-ip-acct enable
web-auth acct-update-interval 5
web-auth portal key ruijie
```

On SMP:

Go to Authentication & Authority > User Group from the left menu. Choose the user group you want to enable MAC authentication. Click Modify. Then click tab Behavior Restrict, enable “An account can register 3 mobile terminals”

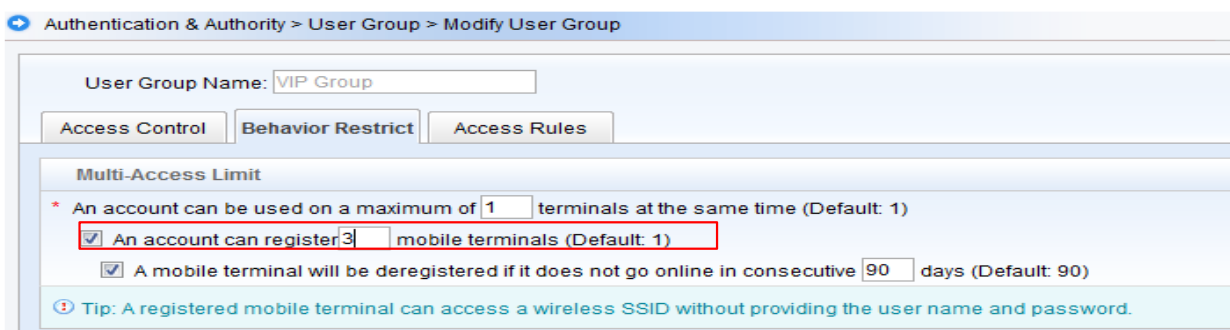
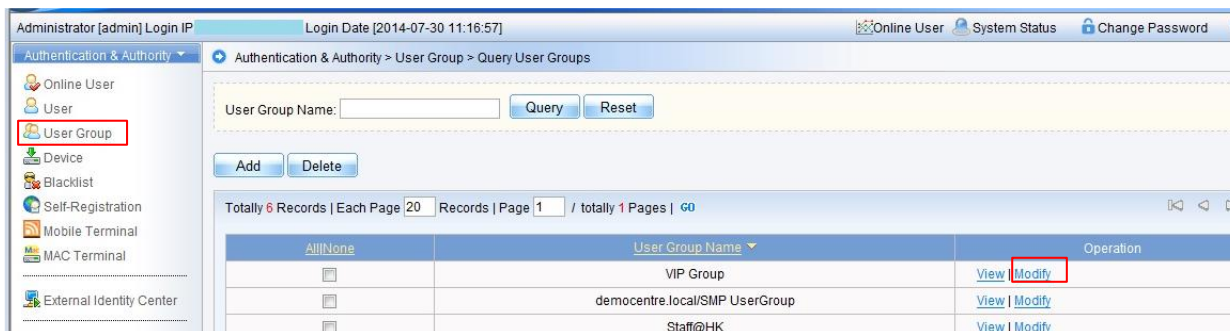

6.1.2.3 QR Code Authentication

Overview

Understanding QR Code Authentication

QR Code authentication feature enables you to scan the QR code of a portal using a QR code reader on your mobile device.

Step 1: Staff passes “802.1x” or “webauth” authentication first

Step 2: Visitors connects to SSID “qrcode”, authentication portal pops up automatically soon, displaying a QRCode Diagram.

Step 3: Staff scans the QR Code, and set the validation period for this temple account (1 day at most).

Step 4: Visitors passes authentication and start surfing.

Note: To use this feature, you need to have a QR code reader app installed on your mobile.

I. Network Topology

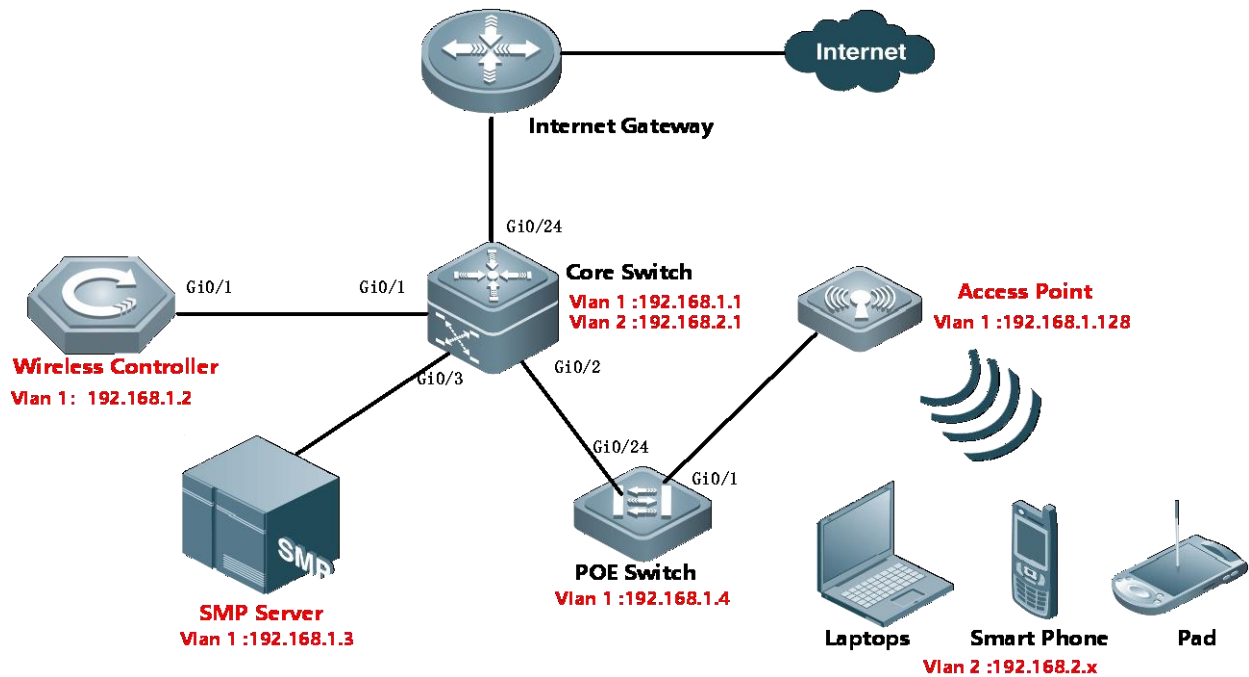

II. Configuration Tips

Configuring Network Infrastructures

1. Finish configuring Internet gateway, Core switch and POE Switch including Vlan 1&2 creation, IP assignment and others required.
2. All wired&wireless devices point gateway to Core Switch.

III. Configuration Steps

On AC:

```

vlan 1
vlan 2

interface gi0/1
description Link-to-CoreSwitch
switchport mode trunk
switchport trunk allowed vlan remove 3-4094

interface vlan 1
ip address 192.168.1.2 255.255.255.0

```

```
interface loopback 0
ip address 1.1.1.1 255.255.255.255

ip route 0.0.0.0 0.0.0.0 192.168.1.1

service dhcp
ip dhcp pool ForAP
network 192.168.1.0 255.255.255.0 192.168.1.128 192.168.1.200
option 138 ip 1.1.1.1
default-router 192.168.1.1
dns-server 8.8.8.8

ip dhcp pool ForUsers
network 192.168.2.0 255.255.255.0
default-router 192.168.2.1
dns-server 8.8.8.8

aaa new-model

aaa group server radius smp
server 192.168.1.3
radius-server host 192.168.1.3 key ruijie

aaa accounting update
aaa accounting update periodic 5
snmp-server enable traps
snmp-server community ruijie rw
ip dhcp snooping
dot1x valid-ip-acct enable
```

On SMP:

1. Go to Authentication & Authority > Device > Add

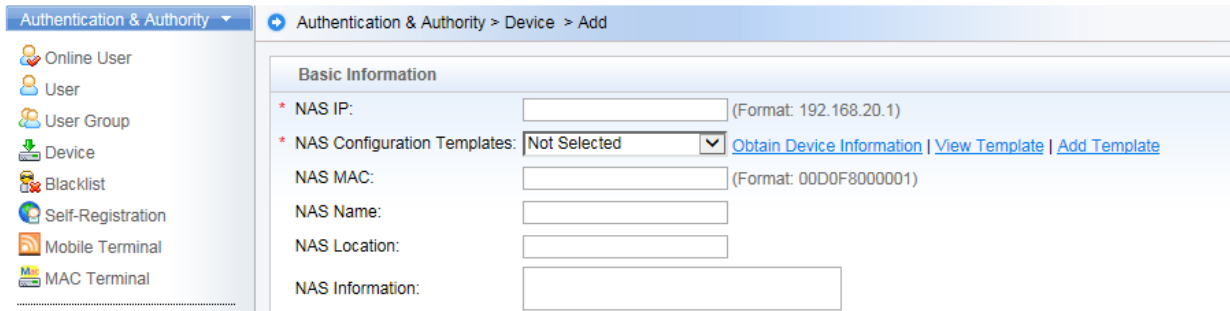
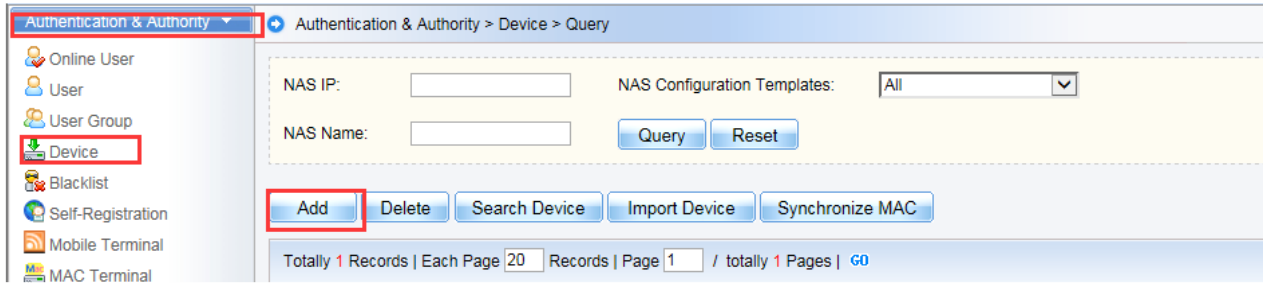

2. Fill in the NAS IP and Choose “Ruijie Wireless device” in the drop-down list. System will prompt “obtaining device information and return a failed message”. It doesn’t matter, because we haven’t set the correct template.

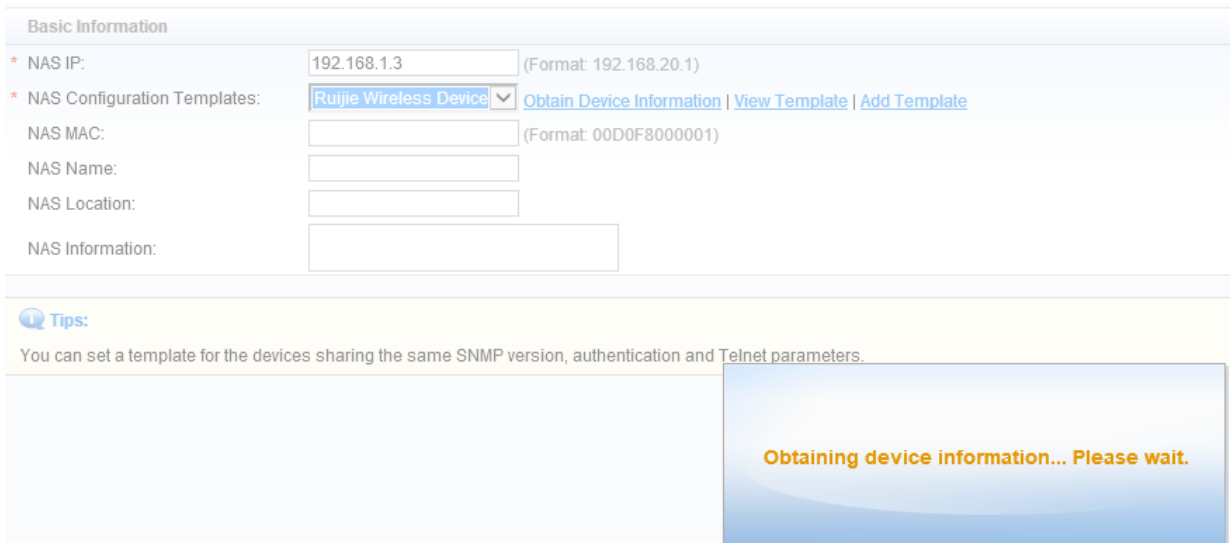

Authentication & Authority > Device > Add

Basic Information

* NAS IP: (Format: 192.168.20.1)

* NAS Configuration Templates: [Obtain Device Information](#) [View Template](#) [Add Template](#)

NAS MAC: (Format: 00D0F8000001)

NAS Name:

NAS Location:

NAS Information:

Tips:
You can set a template for the devices sharing the same SNMP version, authentication and Telnet parameters.

3. Click "View Template", a new windows pops up displaying current template information, then click "Modify"

Basic Information

* NAS IP: (Format: 192.168.20.1)

* NAS Configuration Templates: [Obtain Device Information](#) [View Template](#) [Add Template](#)

NAS MAC: (Format: 00D0F8000001)

NAS Name:

NAS Location:

NAS Information:

4. Follow below to set according fields:

Identity Authentication Key: ruijie
 Web authentication Key : ruijie
 SNMP v2c Community : ruijie

Authentication & Authority > Device > NAS Configuration Templates > Modify

Basic Information

* Template Name: * Type: ▾

Identity Authentication Configuration

* Identity Authentication Key:

! Tips: The system and devices perform user authentication via the Radius Protocol. Identity authentication key is used for the encryption of d should be the same as that of the devices.

Web Authentication Configuration

Web authentication Key:

! Tips: After the Web authentication key is specified, the system will support Web authentication.

SNMP Configuration

* SNMP v2c Community:

! Tips: The SNMP configuration should be the same as that on the devices. Otherwise the system cannot manage the devices.

Security Management

Device based NAC: Supported Unsupported

Tips:
You can set a template for the devices sharing the same SNMP version, authentication and Telnet parameters.

5. Click “Obtain Device information” again, device information is obtained successfully this time. Click “Add”

Authentication & Authority > Device > Modify

Basic Information

* NAS IP:

* NAS Configuration Templates: ▾ [Obtain Device Information](#) | [View Template](#) | [Add Template](#)

NAS MAC: (Format: 00D0F8000001)

NAS Name:

NAS Location:

NAS Information:

Tips:
You can set a template for the devices sharing the same SNMP version, authentication and Telnet parameters.

Configuring QR Code Authentication

```
aaa accounting network acct-web start-stop group smp
```

```
aaa authentication web-auth auth-web group smp
web-auth accounting v2 acct-web
web-auth authentication v2 auth-web

wlan-config 30 "Ruijie QRCode Auth"
    enable-broad-ssid

ap-group default
interface-mapping 30 2

web-auth template qrcode v2
    ip 172.29.2.4
    url http://172.29.2.4:80/smp/qrcodeservlet

wlansec 30
    web-auth authentication v2 auth-web
    web-auth accounting v2 acct-web
    web-auth portal qrcode
    webauth

web-auth portal key ruijie
radius-server attribute 31 mac format ietf
snmp-server community ruijie rw
snmp-server enable traps
http redirect direct-site 192.168.2.1 arp
```

On SMP:

Step 1: Grant employee permission to scan QR code

Go to **Authentication & Authority > User Group** from the left menu. Click **Modify**.

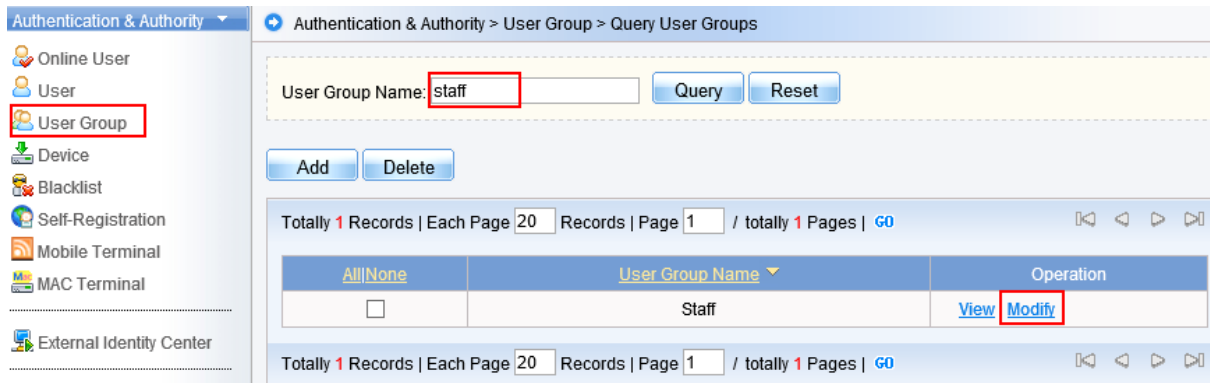

Choose **Behavior Restrict**,

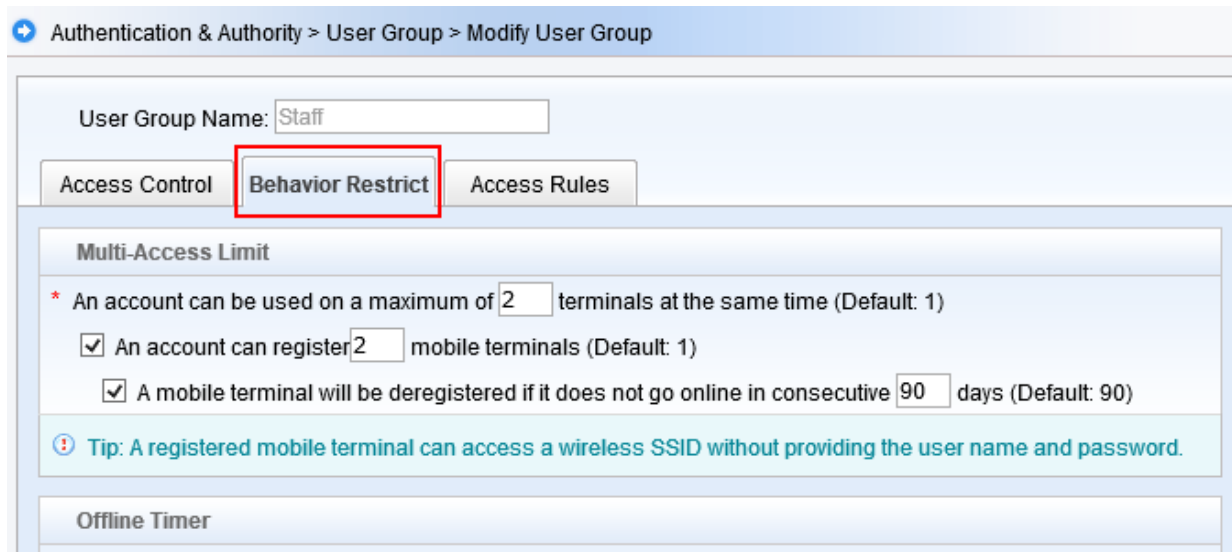

Find the "Guest User Management Rights" option, then enable **Allow guest users to access network by scanning a QR Code**.

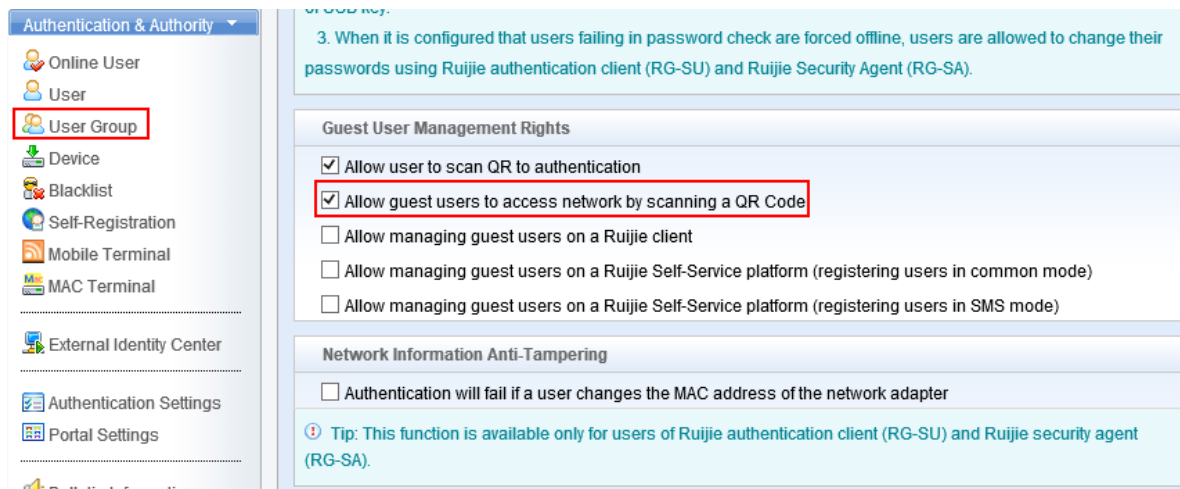

Step 2: Configure portal for QR Code

Go to Authentication & Authority > Portal Settings from the left menu. Click Enable Guest Registration, then Click Enable Guest QR Code Registration. Customize the Message for QR Code Scanning and Message for Successful QR Code Authentication

The screenshot displays the 'Authentication & Authority' configuration page, specifically the 'Portal Settings' section. The left sidebar shows the navigation menu with 'User Group' selected. The main configuration area includes the following settings:

- Enable Guest Registration**
- * Guest Validity Period: 0 Day(s) 4 Hour(s) 0 Minute(s) (Default: 1 day, range: 5 minutes to 365 days)
- Welcome to Ruijie QRCode authentication
www.ruijienetworks.com
- * Bulletin Board Information:
- Guest scan QR code to register [QR logo customization](#)
- * User Group: Default User Group [Select User Group](#)
- * QR wizard steps : Pleass scan your QR card to finish authentication!
- * QR authentication success message : Guest QR authentication success! www.ruijienetworks.com
- Enable Guest QR Code Registration**
- Enable Guest Validity Period by Scanner
- * Message for QR Code Scanning: Please ask the reception personnel to scan the QR Code. www.ruij
- * Message for Successful QR Code Authentication: You have passed QR Code authentication.
 You can now access

6.1.2.4 SMS Registration Authentication

Overview

Understanding SMS Registration Authentication

Step 1: Visitors connects to SSID “Ruijie SMS Auth”, authentication portal pops up automatically soon.

Step 2: Choose Tab “Visitors Authentication” and fill in the phone number, then click “Acquire sms password”

Step 3: A SMS including password will send to the specified number soon.

Step 4: Visitors fill in the password on authentication portal, then start surfing the Internet

I. Network Topology

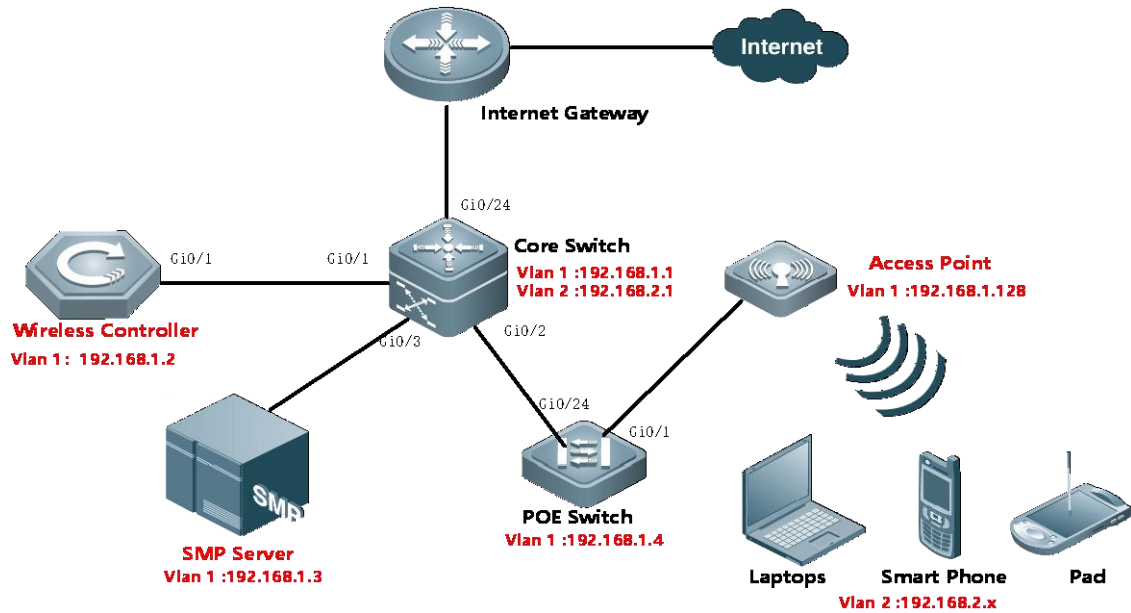

II. Configuration Tips

Configuring Network Infrastructures

1. Finish configuring Internet gateway, Core switch and POE Switch including Vlan 1&2 creation, IP assignment and others required.
2. All wired&wireless devices point gateway to Core Switch.

III. Configuration Steps

On AC:

```

vlan 1
vlan 2

interface gi0/1
description Link-to-CoreSwitch
switchport mode trunk
switchport trunk allowed vlan remove 3-4094
interface vlan 1
ip address 192.168.1.2 255.255.255.0

interface loopback 0
ip address 1.1.1.1 255.255.255.255

```

```

ip route 0.0.0.0 0.0.0.0 192.168.1.1

service dhcp

ip dhcp pool ForAP
network 192.168.1.0 255.255.255.0 192.168.1.128 192.168.1.200
option 138 ip 1.1.1.1
default-router 192.168.1.1
dns-server 8.8.8.8

ip dhcp pool ForUsers
network 192.168.2.0 255.255.255.0
default-router 192.168.2.1
dns-server 8.8.8.8

aaa new-model

aaa group server radius smp
server 192.168.1.3
radius-server host 192.168.1.3 key ruijie

aaa accounting update
aaa accounting update periodic 5
snmp-server enable traps
snmp-server community ruijie rw
ip dhcp snooping
dot1x valid-ip-acct enable

```

On SMP:

1. Go to Authentication & Authority > Device > Add

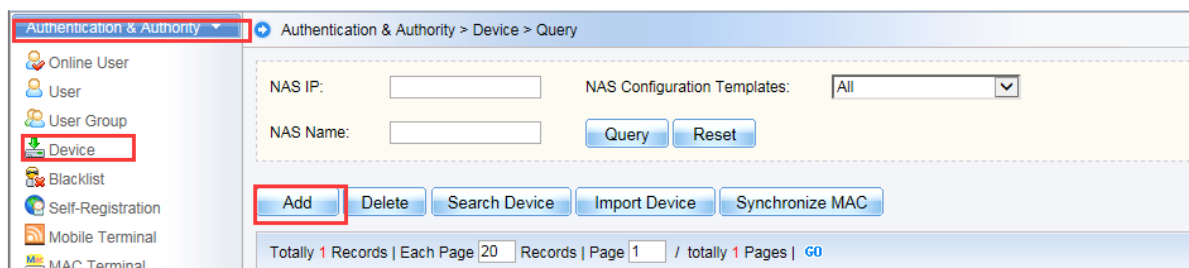

Authentication & Authority > Device > Add

Basic Information

* NAS IP: (Format: 192.168.20.1)

* NAS Configuration Templates: [Obtain Device Information](#) | [View Template](#) | [Add Template](#)

NAS MAC: (Format: 00D0F8000001)

NAS Name:

NAS Location:

NAS Information:

2. Fill in the NAS IP and Choose “Ruijie Wireless device”in the drop-down list. System will prompt “obtaining device information and return a failed message”. It doesn’t matter, because we haven’t set the correct template.

Basic Information

* NAS IP: (Format: 192.168.20.1)

* NAS Configuration Templates: [Obtain Device Information](#) | [View Template](#) | [Add Template](#)

NAS MAC: (Format: 00D0F8000001)

NAS Name:

NAS Location:

NAS Information:

Tips:
You can set a template for the devices sharing the same SNMP version, authentication and Telnet parameters.

Obtaining device information... Please wait.

Authentication & Authority > Device > Add

Basic Information

* NAS IP: (Format: 192.168.20.1)

* NAS Configuration Templates: [Obtain Device Information](#) | View Template | [Add Template](#)

NAS MAC: (Format: 00D0F8000001)

NAS Name:

NAS Location:

NAS Information:

Tips:
You can set a template for the devices sharing the same SNMP version, authentication and Telnet parameters.

3. Click “View Template” , a new windows pops up displaying current template information, then click “Modify”

Basic Information	
* NAS IP:	<input type="text" value="192.168.2.3"/> (Format: 192.168.20.1)
* NAS Configuration Templates:	<input type="text" value="Ruijie Wireless Device"/> Obtain Device Information View Template Add Template
NAS MAC:	<input type="text"/> (Format: 00D0F8000001)
NAS Name:	<input type="text"/>
NAS Location:	<input type="text"/>
NAS Information:	<input type="text"/>

4. Follow below to set according fields:

Identity Authentication Key: ruijie

Web authentication Key : ruijie

SNMP v2c Community : ruijie

Authentication & Authority > Device > NAS Configuration Templates > Modify

Basic Information	
* Template Name:	<input type="text" value="Ruijie Wireless Device"/>
* Type:	<input type="text" value="Ruijie Wireless Device"/>

Identity Authentication Configuration	
* Identity Authentication Key:	<input type="text" value="ruijie"/>
<p>Tips: The system and devices perform user authentication via the Radius Protocol. Identity authentication key is used for the encryption of d should be the same as that of the devices.</p>	

Web Authentication Configuration	
Web authentication Key:	<input type="text" value="ruijie"/>
<p>Tips: After the Web authentication key is specified, the system will support Web authentication.</p>	

SNMP Configuration	
* SNMP v2c Community:	<input type="text" value="ruijie"/>
<p>Tips: The SNMP configuration should be the same as that on the devices. Otherwise the system cannot manage the devices.</p>	

Security Management	
Device based NAC:	<input type="radio"/> Supported <input checked="" type="radio"/> Unsupported

Tips:
You can set a template for the devices sharing the same SNMP version, authentication and Telnet parameters.

5. Click "Obtain Device information" again, device information is obtained successfully this time. Click "Add"

Authentication & Authority > Device > Modify

Basic Information

* NAS IP:

* NAS Configuration Templates: [Obtain Device Information](#) | [View Template](#) | [Add Template](#)

NAS MAC: (Format: 00D0F8000001)

NAS Name:

NAS Location:

NAS Information:

Tips:
You can set a template for the devices sharing the same SNMP version, authentication and Telnet parameters.

Configuring SMS Registration Authentication

On AC:

```

aaa accounting network acct-guest start-stop group smp
aaa authentication dot1x auth-guest group smp

wlan-config 40 "Ruijie SMS Auth"
enable-broad-ssid

ap-group default
interface-mapping 40 2

portal-server smsauth ip 192.168.1.3 url http://192.168.1.3:80/smp/commonauth

wlansec 40
web-auth authentication v2 auth-guest
web-auth accounting v2 acct-guest
web-auth portal smsauth
webauth

web-auth acct-update-interval 5
http redirect direct-site 192.168.2.1 arp
web-auth portal key key

```

```
radius dynamic-authorization-extension enable
radius-server attribute 31 mac format ietf
snmp-server community ruijie rw
snmp-server enable traps
```

On SMS Gateway:

Go to SMP Server Windows Device Manager and make sure Driver of GSM-SM Modem has been installed successfully

On SMP:

Step 1: Add SMS gateway on SMP

Go to System Maintenance> SMS Settings from the left menu. Enable SMS Settings, Click Enable SMS Modem. Fill in Port (serial port), Baud Rate, and choose Manufacture Model. Usually, keep the default value of SIM Card PIN Code. After finish configuring, click Send a Test Message to validate.

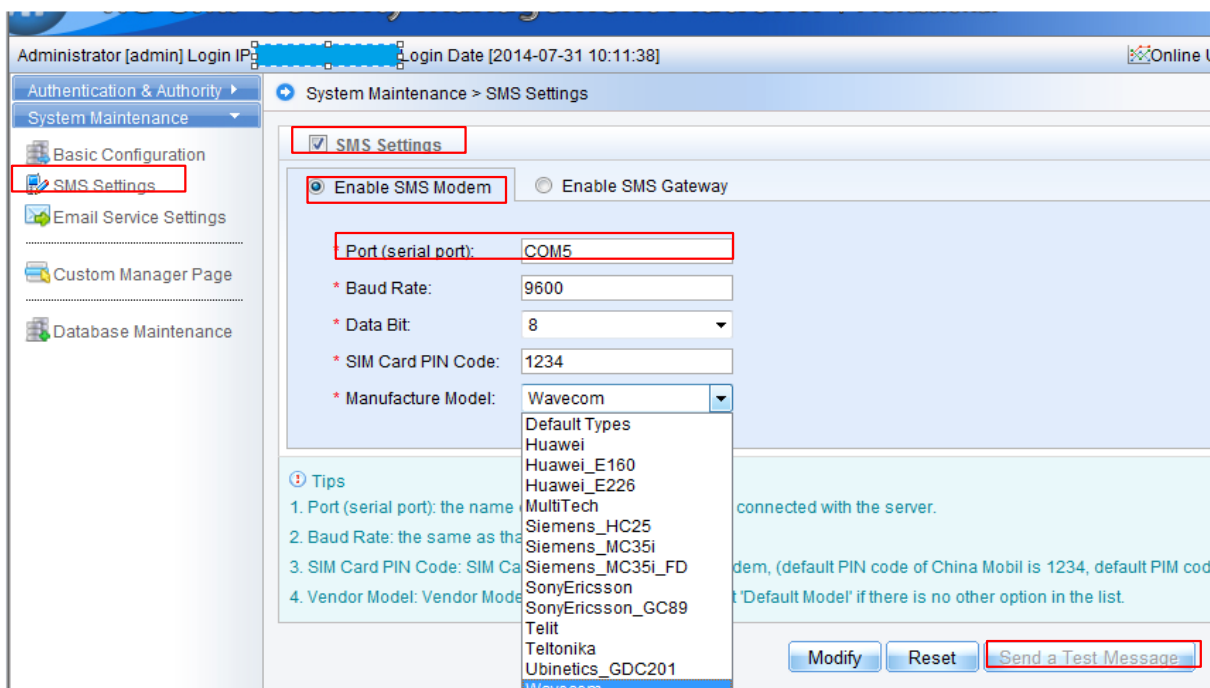

Step 2: Configure built-in portal for SMS Authentication

Go to Authentication & Authority > Portal Settings from the left menu. Click Enable Guest Registration, then Click Enable Guest SMS Self-Service Registration. Customize the SMS Message

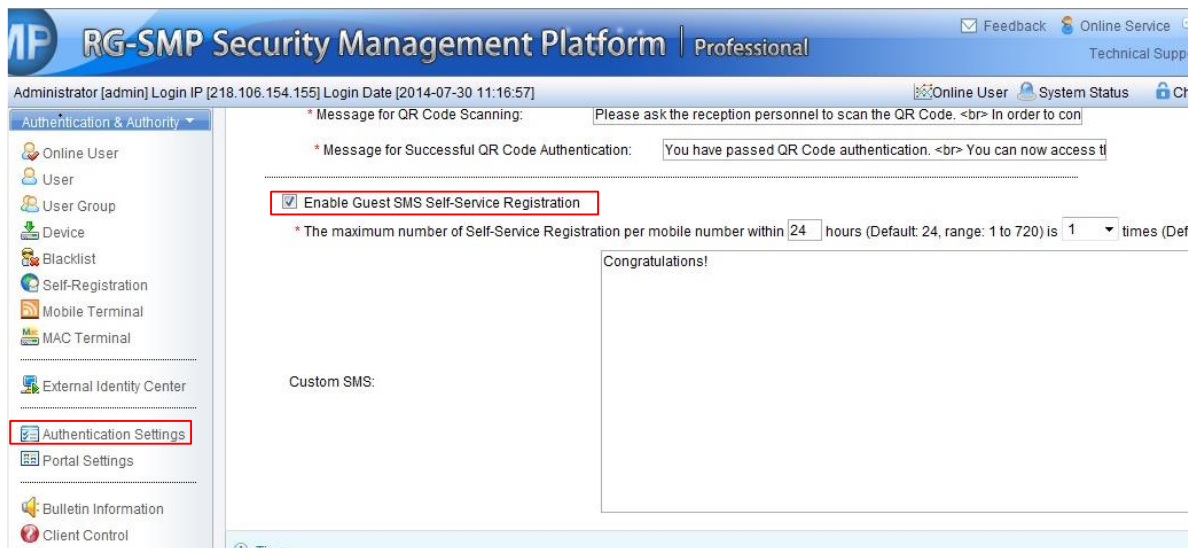

7 Appendix

7.1 Ruijie Fit AP&AC EWeb Configuration Guide for RGOS 11.x V1.2



Ruijie Fit AP&AC
EWeb Configurati

If needed, you could find the attachment in our official website with the following download link:

<http://www.ruijienetworks.com/service/document/read/57983>

7.2 Ruijie Fat AP EWeb Configuration Guide For RGOS 11.x V1.1



Ruijie Fat AP
EWeb Configurati

If needed, you could find the attachment in our official website with the following download link:

<http://www.ruijienetworks.com/service/document/read/57852>

7.3 Import license to AC by CLI or WEB

Via CLI:

CD disk license import :

```
WS6108(config)#set license xxxx-xxxx-xxxx-xxxx-xxxx-xxxx-xxxx-xxxx
```

Import license file :

(1)Import local license file to AC (Take tftp as an example)

```
Ruijie#copy tftp://192.168.64.2/LIC-WLAN-AP-800000015692434.lic flash:/LIC-WLAN-AP-800000015692434.lic---->
192.168.64.2 is TFTP server IP address
```

(2)Install license file

```
Ruijie#license install flash:/LIC-WLAN-AP-800000015692434.lic
Are you sure to install this license[y/n]:y
Success to install license file, service name: LIC-WLAN-AP-8 ----> Succeed to install the license, 8 APs has been
increased
```

Via WEB:

CD disk license import

Access AC WEB homepage, choose 'License' in 'System', and then choose 'Activation Code'. Input activation code, then clicking 'add'.

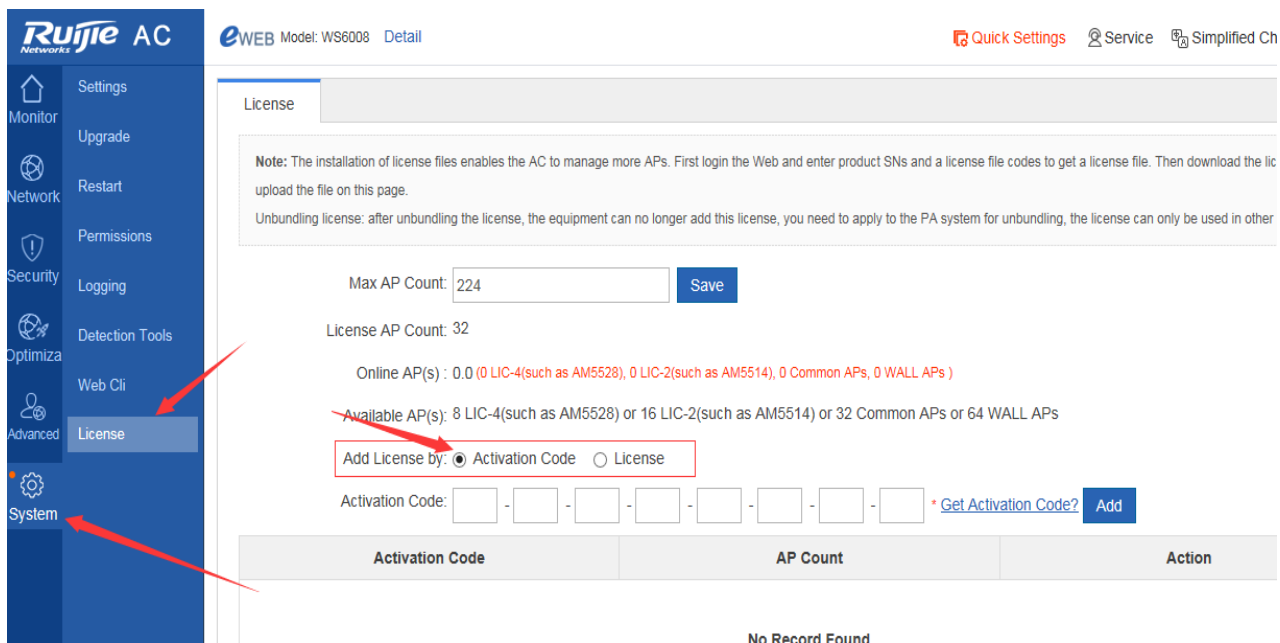

License file import

Access AC WEB homepage, choose 'License' in 'System', and then choose 'License'.

Choose license file location you downloaded in, and then click 'Install'.

The screenshot shows the Ruijie AC eWEB interface for Model WS6008. The 'License' page includes a sidebar with navigation options: Settings, Monitor, Upgrade, Network, Restart, Permissions, Security, Logging, Detection Tools, Web Cli, License, and System. The main content area contains the following information:

- Note:** The installation of license files enables the AC to manage more APs. First login the Web and enter product SNs and a license file codes to get a license file. Then download the license file and upload the file on this page.
- Unbundling license:** after unbundling the license, the equipment can no longer add this license, you need to apply to the PA system for unbundling, the license can only be used in other equipment.
- Max AP Count:** 224 (with a 'Save' button)
- License AP Count:** 32
- Online AP(s):** 0.0 (0 LIC-4(such as AM5528), 0 LIC-2(such as AM5514), 0 Common APs, 0 WALL APs)
- Available AP(s):** 8 LIC-4(such as AM5528) or 16 LIC-2(such as AM5514) or 32 Common APs or 64 WALL APs
- Add License by:** Activation Code License
- File Upload:** [file...] [Install] [How to get license file]

Below the form is a table with columns: License, Product Type, and Action. The table is currently empty, displaying 'No Record Found'.

For more details, please find the attachment in our official website with the following download link:

<http://www.ruijienetworks.com/support/licensing>

7.4 Common Verification Commands

This section lists some common verification commands on AC, remember to collect these information and share to Ruijie Postsales when you encounter problem and ask for help.

Command list

1. show cpu
2. show memory
3. show running-config
4. show version
5. show ap-config summary
6. show ac-config client
7. show dot11 associations all-client

show cpu

Generally, for "CPU utilization in five minutes" as a reference, AC works properly when CPU utilization below 80%

```
Ruijie#show cpu
-----
CPU Using Rate Information
CPU utilization in five seconds: 7.60%
CPU utilization in one minute: 7.10%
CPU utilization in five minutes: 8.50%

NO      5Sec    1Min    5Min Process
  1    0.00%  0.00%  0.00% init
  2    0.00%  0.00%  0.00% kthreadd
  3    0.00%  0.00%  0.00% ksoftirqd/0
  4    0.00%  0.00%  0.00% events/0
  5    0.00%  0.00%  0.00% khelper
  8    0.00%  0.00%  0.00% async/mgr
 42    0.00%  0.00%  0.00% sync_supers
 44    0.00%  0.00%  0.00% bdi-default
 45    0.00%  0.00%  0.00% kblockd/0
 73    0.00%  0.00%  0.00% kswapd0
 74    0.00%  0.00%  0.00% aio/0
 75    0.00%  0.00%  0.00% crypto/0
112    0.00%  0.00%  0.00% mtdblockd
134    0.00%  0.00%  0.00% ubi_bgt0d
```

show memory

Generally, AC works properly when Memory utilization below 80%.

```
Ruijie#show memory
System Memory: 262144KB total, 164312KB used, 97832KB free, 62.6% used rate
Used detail: 84564KB active, 30276KB inactive, 27512KB mapped, 56148KB slab, 20180KB
core, 0KB others

PID     Vsd     Text     Rss      Data     Stack    Total    Process
9349    0       100      1788     33104    84       37756    rl-con/258
9348    0       40       1288     16604    84       21444    rg-telnetd
996     0       20       1372     220      84       3192     rg-mtdoops-cli
979     0       384     8916     41232    84       54640    snooping.elf
975     0       88       2344     352      84       5740     wds_proc
970     0       28       2264     348      84       5768     wvas_sa.elf
966     0       328     3260     828      84       7308     wvas_wids.elf
956     0       148     2624     8576     84       14680    wvas_sfn.elf
937     0       76       2860     8416     84       15756    wlan-intf-mib.e
933     0       44       2036     16824    84       21656    tftpd.elf
929     0       108     2292     8452     84       14124    ntp.elf
924     0       228     5808     416      84       7904     wbs_sec.elf
883     0       116     3388     8396     84       15564    local_eap
877     0       52       6864     8440     84       20752    arp_proxy.elf
873     0       88       2088     8372     84       13296    dhcpc.elf
862     0       196     6156     8468     84       17584    vrrp.elf
856     0       348     8560     33604    520     47188    dhcp.elf
849     0       596     9444     21908    84       37844    dot1x
842     0       100     2820     10076    84       17812    tacplust
```

show running-config

Display AC configuration

```

Ruijie#show running-config
Building configuration...
Current configuration: 2395 bytes

version 11.1(2)B1
!
wlan-config 5 ruijie
!
wlan-config 10 gongzhong
!
ap-group andy
  interface-mapping 10 1 ap-wlan-id 1
!
ap-group default
!
ap-config all
  logging server 1.1.1.1
!
ac-controller
  ac-name AC-1
  country CN
  802.11g network rate 1 mandatory
  802.11g network rate 2 mandatory
  802.11g network rate 5 mandatory
  802.11g network rate 6 supported
  802.11g network rate 9 supported
  802.11g network rate 11 mandatory

```

Display AP configuration on AC

```

Ruijie#show ap-conf running
Building configuration...
Current configuration: 107 bytes

!
ap-config ap320
  ap-mac 1414.4b70.3583
  no 11acsupport enable radio 2
!!!!
ap-config ap32
!
end

```

show version

Generally, you can check time, software and hardware version when execute this command "show version"

```

Ruijie#show version
System description      : Ruijie Gigabit wireless Switch(ws5302) By Ruijie Networks.
System start time      : 2014-12-12 12:20:08
System uptime          : 4:02:01:30
System hardware version : 1.10
System software version : AC_RGOS 11.1(2)B1
System patch number     : NA
System serial number    : 9071EHC850002
System boot version     : 1.1.6

```

show ap-config summary

It's a useful command, you can view below informations:

1. Online AP number
2. AP name
3. AP IP & MAC address
4. AP Radio status (enable or not, which channel, the power percentage)
5. The user number AP carries

```
Ruijie#show ap-config summary
===== show ap status =====
Radio: Radio ID
      E = enabled, D = disabled, N = Not exist
      Current Sta number
      Channel: * = Global
      Power Level = Percent

Online AP number: 1 online/offline AP number
Offline AP number: 1

AP Name           IP Address      Mac Address      Radio      online user      channel. "*"      power percentage      up/off time      State
-----
ap320             192.168.10.2   1414.4b70.3583  1 E 0      6*            100 2 E 0 153* 100 1:04:14:09 Run
```

show ac-config client

It's a useful command, you can view below informations:

1. Current user number AC is carrying
2. Wireless user IP & MAC address
3. Authentication method
4. The AP & WLAN wireless user is connected.

```
Ruijie#show ac-config client
===== show sts status =====
AP      : ap name /radio id
status  :Speed/Power Save/Work Mode/Roaming State, E = enable power save, D = disable power save

Total Sta Num : 1 totally online wireless user
               "1" indicates user

STA MAC      IP Address      AP connects to radio 1      Wlan Vlan      Status      Asso Auth Link Auth      Up time
-----
78e4.00d3.1183 192.168.248.2 te/1      1 1      65.0M/D/bn Open      Open      0:00:08:10
```

show dot11 associations all-client

Execute this command on AP(No matter FAT or Fit), display wireless user informations.

```
Ruijie#show dot a a
RADIO-ID WLAN-ID ADDR      AID CHAN RATE_DOWN RATE_UP RSSI ASSOC_TIME IDLE TXSEQ RXSEQ ERP STATE CAPS HTCAPS
1      1      74:e2:f5:82:b8:da 1 5 65.0M 26.0M 32 0:00:10 0 16 272 0x0 0x3 ESS
```

"RSSI" = 32 indicates 32-95 = -63 dBm.

Usually, if the value is bigger than -75dBm, it is a good wireless strength; if the value is smaller than -75dBm, user may have packet loss and bad experience.

-63dBm is bigger than -75dBm, so user will have good experience.